

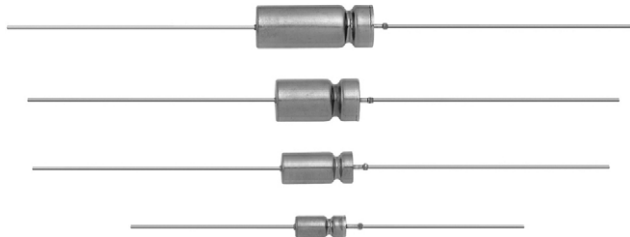

THE DATASHEET OF
135D276X9125F6



Wet Tantalum Capacitors Tantalum-Case With Glass-to-Tantalum Hermetic Seal for -55 °C to +200 °C Operation



LINKS TO ADDITIONAL RESOURCES



PERFORMANCE CHARACTERISTICS

Operating Temperature: -55 °C to +85 °C
(to +200 °C with voltage derating)

Capacitance Tolerance: at 120 Hz, +25 °C
± 20 % standard. ± 10 %, ± 5 % available as special.

DC Leakage Current (DCL Max.): at +25 °C and above:
leakage current shall not exceed the values listed in the Standard Ratings table.

Life Test: for details follow this [link](#)

FEATURES

- Axial through-hole terminations: standard tin / lead (SnPb), 100 % tin (RoHS-compliant) available
- Standard and extended ratings
- Model 135D tantalum-case electrolytic capacitors incorporate the advantages of all the varieties of electrolytic capacitors and eliminate most of the disadvantages. These units have a 3 V reverse voltage capability at +85 °C and a higher ripple current capability than any other electrolytic type with similar combinations of capacitance and case size
- Designed for the aerospace applications, this capacitor was developed under partial sponsorship of the Marshall Space Flight Center, National Aeronautics and Space Administration. The capacitors have a high resistance to damage from shock and vibration. Extended range ratings and high temperature designs are available
- Model 135D capacitors are commercial equivalents of Tansitor style; AQ, AR, HAQ, HAR, Mallory-NACC Style; TLT, TXT, THT, THX and Military Style CLR79 and CLR81, designed to meet the performance requirements of Military Specification MIL-PRF-39006/22/25. Capacitors to meet MIL-PRF-39006/22/25 should be ordered by part numbers shown in that specification
- Material categorization: for definitions of compliance please see www.vishay.com/doc?99912



RoHS*
Available



Note

* This datasheet provides information about parts that are RoHS-compliant and / or parts that are non RoHS-compliant. For example, parts with lead (Pb) terminations are not RoHS-compliant. Please see the information / tables in this datasheet for details

| ORDERING INFORMATION | | | | | | |
|----------------------|--|--|--|----------------------------------|---|--|
| 135D | 306 | X0 | 006 | C | 2 | E3 |
| MODEL | CAPACITANCE | CAPACITANCE TOLERANCE | DC VOLTAGE RATING AT +85 °C | CASE CODE | STYLE NUMBER | RoHS-COMPLIANT |
| | This is expressed in picofarads. The first two digits are the significant figures. The third is the number of zeros to follow. | X0 = ± 20 % X9 = ± 10 % X5 = ± 5 % | This is expressed in volts. To complete the three-digit block, zeros precede the voltage rating. | See Ratings and Case Codes table | Standard temperature (max. +125 °C) 0 = no insulating sleeve 2 = polyester insulation sleeve 3 = high temperature film insulation High temperature (max. +200 °C) 6 = high temperature film insulation 8 = no insulating sleeve | E3 = 100 % tin termination (RoHS-compliant design) Blank = SnPb termination (standard design) |

Note

- Packaging: the use of formed plastic trays for packaging these axial lead components is standard. Tape and reel is not available due to the unit weight

DIMENSIONS in inches [millimeters]

Style CLR79
Style CLR81

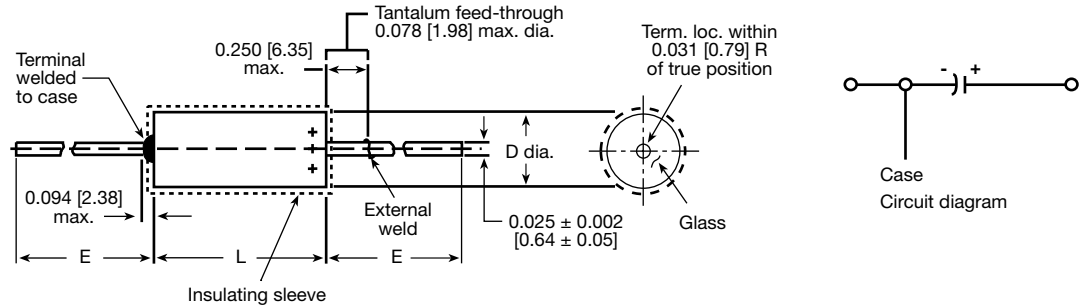

| CASE CODE | BARE CASE | | WITH INSULATING SLEEVE | | E LEAD LENGTH | WEIGHT (oz. / g) (Max.) |
|-----------|--------------------------------|--|------------------------|------------------|---------------------------------|-------------------------------|
| | D | L | D (MAX.) | L (1) | | |
| C | 0.188 ± 0.016 [4.78 ± 0.41] | 0.453 + 0.031 / - 0.016 [11.51 + 0.79 / - 0.41] | 0.219 [5.56] | 0.565 [14.35] | 1.500 ± 0.250 [38.10 ± 6.35] | 0.09 [2.6] |
| F | 0.281 ± 0.016 [7.14 ± 0.41] | 0.641 + 0.031 / - 0.016 [16.28 + 0.79 / - 0.41] | 0.312 [7.92] | 0.785 [19.94] | 2.250 ± 0.250 [57.15 ± 6.35] | 0.22 [6.2] |
| T | 0.375 ± 0.016 [9.53 ± 0.41] | 0.766 + 0.031 / - 0.016 [19.46 + 0.79 / - 0.41] | 0.406 [10.31] | 0.95 [24.13] | 2.250 ± 0.250 [57.15 ± 6.35] | 0.41 [11.6] |
| K | 0.375 ± 0.016 [9.53 ± 0.41] | 1.062 + 0.031 / - 0.016 [26.97 + 0.79 / - 0.41] | 0.406 [10.31] | 1.31 [33.27] | 2.250 ± 0.250 [57.15 ± 6.35] | 0.62 [17.7] |

Note

(1) Typical length, for reference only

SMD PRODUCT DIMENSIONS in inches [millimeters]

Styles J, K

| Term. code | Solder type |
|------------|----------------------------|
| J | SnPb |
| K | 100 % tin (RoHS-compliant) |

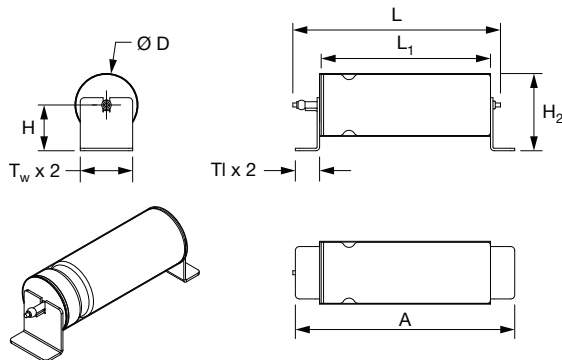

Styles L, M

| Term. code | Solder type |
|------------|----------------------------|
| L | SnPb |
| M | 100 % tin (RoHS-compliant) |

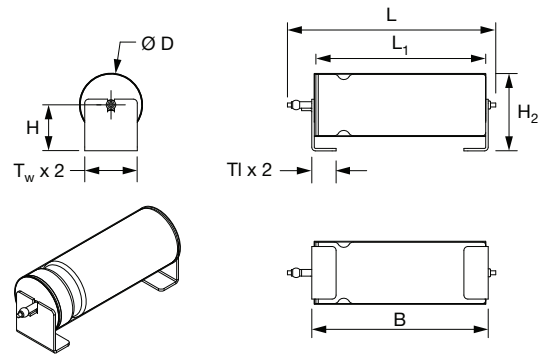

| CASE CODE | | A | B | Tl | H | Tw ± 0.008 | H2 | L | L1 | D |
|-----------|--------------------|-----------------|-----------------|----------------|----------------|----------------|-----------------|-----------------|--|-----------------|
| TYPE 135D | CLR 79 / 81 EQUIV. | (max.) | (max.) | (max.) | (max.) | | (max.) | (max.) | | (max.) |
| C | T1 | 0.773 [19.6] | 0.513 [13.0] | 0.157 [4.0] | 0.177 [4.5] | 0.158 [4.0] | 0.296 [7.5] | 0.705 [17.9] | 0.469 + 0.031 / - 0.016 [11.91 + 0.79 / - 0.41] | 0.228 [5.8] |
| F | T2 | 1.001 [25.4] | 0.720 [18.3] | 0.157 [4.0] | 0.212 [5.4] | 0.225 [5.7] | 0.374 [9.5] | 0.903 [22.9] | 0.668 + 0.012 / - 0.12 [16.97 + 0.30 / - 0.30] | 0.316 [8.0] |
| T | T3 | 1.143 [29.0] | 0.858 [21.8] | 0.157 [4.0] | 0.280 [7.1] | 0.331 [8.4] | 0.492 [12.5] | 1.051 [26.7] | 0.806 + 0.012 / - 0.12 [20.47 + 0.30 / - 0.30] | 0.397 [10.1] |
| K | T4 | 1.432 [36.4] | 1.140 [29.0] | 0.157 [4.0] | 0.295 [7.5] | 0.331 [8.4] | 0.492 [12.5] | 1.343 [34.1] | 1.062 + 0.031 / - 0.016 [26.97 + 0.79 / - 0.41] | 0.397 [10.1] |

Note

• Use appropriate adhesive between capacitor body and the board for improved mechanical strength



| RATINGS AND CASE CODES (Standard) | | | | | | | | | | | | |
|-----------------------------------|-----|-----|------|------|------|------|------|------|------|------|-------|-------|
| µF | 6 V | 8 V | 10 V | 15 V | 25 V | 30 V | 35 V | 50 V | 60 V | 75 V | 100 V | 125 V |
| 1.7 | | | | | | | | | | | | C |
| 2.2 | | | | | | | | | | | C | |
| 2.5 | | | | | | | | | | | C | |
| 3.5 | | | | | | | | | | C | | |
| 3.6 | | | | | | | | | | | | C |
| 3.9 | | | | | | | | | | | C | |
| 4.0 | | | | | | | | | C | | | |
| 4.7 | | | | | | | | | | | C | |
| 5.0 | | | | | | | | C | | | | |
| 6.8 | | | | | | | | | | C | | |
| 8.0 | | | | | | C | | | | | | |
| 8.2 | | | | | | | | | C | | | |
| 9.0 | | | | | | | | | | | | F |
| 10 | | | | | C | | | C | | | | |
| 11 | | | | | | | | | | | F | |
| 14 | | | | | | | | | | | | F |
| 15 | | | | C | | C | C | | | F | | |
| 18 | | | | | | | | | | | | T |
| 20 | | | C | | | | | | F | | | |
| 22 | | | | | C | F | | | | | F | |
| 25 | | C | | | | | | F | | | | T |
| 30 | C | | | | | | | | | | T | |
| 33 | | | | C | | | | | | F | | |
| 39 | | | | | | | | | F | | | |
| 40 | | | | | | F | | | | T | | |
| 43 | | | | | | | | | | | T | |
| 47 | | | C | | | | | F | | | | |
| 50 | | | | | F | | | | T | | | |
| 56 | | C | | | | | | | | T | | K |
| 60 | | | | | | | | T | | | | |
| 68 | C | | | | | F | F | | T | | | |
| 70 | | | | F | | | | | | | | |
| 82 | | | | | | | | T | | | K | |
| 86 | | | | | | | | | | | K | |
| 100 | | | F | | F | T | | | | | | |
| 110 | | | | | | | | | | K | | |
| 120 | | F | | F | T | | | | | | | |
| 140 | F | | | | | | | | K | | | |
| 150 | | | | | | T | | | | | | |
| 160 | | | | | | | | K | | | | |
| 170 | | | | T | | | | | | | | |
| 180 | | | F | | T | | | | | | | |
| 220 | | F | | | | | | | | | | |
| 250 | | | T | | | | | | | | | |
| 270 | F | | | T | | | K | | | | | |
| 290 | | T | | | | | | | | | | |
| 300 | | | | | | K | | | | | | |
| 330 | T | | | | | | | | | | | |
| 350 | | | | | K | | | | | | | |
| 390 | | | T | | | | | | | | | |
| 430 | | T | | | | | | | | | | |
| 540 | | | | K | | | | | | | | |
| 560 | T | | | | | | | | | | | |
| 750 | | | K | | | | | | | | | |
| 850 | | K | | | | | | | | | | |
| 1200 | K | | | | | | | | | | | |



| RATINGS AND CASE CODES (Extended) | | | | | | | | | | | | | | |
|-----------------------------------|-----|-----|------|------|------|------|------|------|------|------|------|------|-------|-------|
| μF | 6 V | 8 V | 10 V | 15 V | 25 V | 30 V | 35 V | 40 V | 50 V | 60 V | 63 V | 75 V | 100 V | 125 V |
| 3.9 | | | | | | | | | | | | | | C |
| 5.6 | | | | | | | | | | | | C | C | |
| 6.8 | | | | | | | | | | | | | | C |
| 10 | | | | | | | | | | | C | | C | |
| 12 | | | | | | | | | | | | C | | |
| 15 | | | | | | | | | | | | | | F |
| 18 | | | | | | | | | | C | | | | |
| 22 | | | | | | | | | | | | C | | |
| 27 | | | | | | | | | | C | C | | | F |
| 33 | | | | | | | | | C | | | | | |
| 39 | | | | | | | C | C | | | | | F | |
| 47 | | | | | C | C | | | | | | | T | T |
| 56 | | | | | C | C | | | | | | | T | T |
| 68 | | | | | C | | | | | | | F | T | K |
| 82 | | | | C | | | | | | F | | F | | K |
| 100 | | | | C | | | | | F | F | F | | | |
| 110 | | | | | | | | | | | | F | | |
| 120 | | | C | | | | F | | F | | | | K | |
| 150 | | | C | | | F | | | | | | | | |
| 180 | | C | | | F | | | | | | | T | | |
| 200 | | | | | | | | | | | | K | | |
| 220 | C | | | | | F | | K | | T | | K | | |
| 270 | | | | F | F | | | | T | K | | | | |
| 300 | | | | | | T | | | | | | K | | |
| 330 | | | | | | | T | | K | K | | | | |
| 370 | | | | | | | K | K | | | | | | |
| 390 | | | F | F | T | T | | | | | | | | |
| 470 | | | F | | T | T | | K | | | | | | |
| 560 | F | | F | | T | K | | | | | | | | |
| 680 | | F | | T | K | | | | | | | | | |
| 820 | F | | | T | K | | | | | | | | | |
| 1000 | | | | K | | | | | | | | | | |
| 1200 | T | | T | | | | | | | | | | | |
| 1500 | T | T | K | | | | | | | | | | | |
| 1800 | | K | | | | | | | | | | | | |
| 2200 | K | | | | | | | | | | | | | |

| STANDARD RATINGS | | | | | | | | | | | | |
|---|-----------|-----------------|-----------|-----------|-----------|------------|-----------|-----------|--------------------------------|--|------|--|
| CAPACITANCE (μF) | CASE CODE | PART NUMBER (1) | MAX. ESR | | MAX. IMP. | | MAX. DCL | | MAX. CAPACITANCE CHANGE (%) AT | | | MAX. RIPPLE 40 kHz I _{RMS} (mA) |
| | | | AT +25 °C | AT -55 °C | AT -55 °C | AT +125 °C | AT -55 °C | AT +85 °C | AT +125 °C | | | |
| 6 V _{DC} AT +85 °C; 4 V _{DC} AT +125 °C; 3.6 V _{DC} AT +200 °C | | | | | | | | | | | | |
| 30 | C | 135D306X0006C2 | 4.0 | 100 | 1.0 | 2.0 | -40 | +10.5 | +12 | | 820 | |
| 68 | C | 135D686X0006C2 | 3.2 | 60 | 1.0 | 2.0 | -40 | +14 | +16 | | 960 | |
| 140 | F | 135D147X0006F2 | 2.0 | 40 | 1.0 | 3.0 | -40 | +14 | +16 | | 1200 | |
| 270 | F | 135D277X0006F2 | 2.2 | 25 | 1.0 | 6.5 | -44 | +17.5 | +20 | | 1375 | |
| 330 | T | 135D337X0006T2 | 1.4 | 20 | 2.0 | 7.9 | -44 | +14 | +16 | | 1800 | |
| 560 | T | 135D567X0006T2 | 1.3 | 25 | 2.0 | 13.0 | -64 | +17.5 | +20 | | 1900 | |
| 1200 | K | 135D128X0006K2 | 1.0 | 20 | 3.0 | 14.0 | -80 | +25 | +25 | | 2265 | |

Note

(1) Part numbers are for units with ± 20 % capacitance tolerance, standard +125 °C maximum temperature, standard polyesterfilm insulation, and tin-lead terminations. For other capacitance tolerances, other maximum temperatures, insulation and termination options, please consult Ordering Information on first page for proper part number



| STANDARD RATINGS | | | | | | | | | | |
|--|--------------|----------------------------|--------------|--------------|----------|---------|------------------|--------|---------|------------------|
| CAPACITANCE (μ F) | CASE CODE | PART NUMBER ⁽¹⁾ | MAX. ESR | MAX. IMP. | MAX. DCL | | MAX. CAPACITANCE | | | MAX. |
| | | | AT +25 °C | AT -55 °C | (μA) AT | | CHANGE (%) AT | | | RIPPLE |
| | | | 120 Hz | 120 Hz | +25 °C | +85 °C | -55 °C | +85 °C | +125 °C | 40 kHz |
| | | | (Ω) | (Ω) | | +125 °C | | | | I _{RMS} |
| | | | | | | | | | | (mA) |
| 8 V_{DC} AT +85 °C; 5 V_{DC} AT +125 °C; 4.8 V_{DC} AT +200 °C | | | | | | | | | | |
| 25 | C | 135D256X0008C2 | 4.0 | 100 | 1.0 | 2.0 | -40 | +10.5 | +12 | 820 |
| 56 | C | 135D566X0008C2 | 3.3 | 59 | 1.0 | 2.0 | -40 | +14 | +16 | 900 |
| 120 | F | 135D127X0008F2 | 2.6 | 50 | 1.0 | 2.0 | -44 | +17.5 | +20 | 1230 |
| 220 | F | 135D227X0008F2 | 2.4 | 30 | 1.0 | 7.0 | -44 | +17.5 | +20 | 1370 |
| 290 | T | 135D297X0008T2 | 1.8 | 25 | 2.0 | 6.0 | -64 | +17.5 | +20 | 1770 |
| 430 | T | 135D437X0008T2 | 1.4 | 25 | 2.0 | 14.0 | -64 | +17.5 | +20 | 1825 |
| 850 | K | 135D857X0008K2 | 1.0 | 22 | 4.0 | 16.0 | -80 | +25 | +25 | 2330 |
| 10 V_{DC} AT +85 °C; 7 V_{DC} AT +125 °C; 6 V_{DC} AT +200 °C | | | | | | | | | | |
| 20 | C | 135D206X0010C2 | 4.0 | 120 | 1.0 | 2.0 | -32 | +10.5 | +12 | 820 |
| 47 | C | 135D476X0010C2 | 3.7 | 90 | 1.0 | 2.0 | -36 | +14 | +16 | 855 |
| 100 | F | 135D107X0010F2 | 2.4 | 60 | 1.0 | 4.0 | -36 | +14 | +16 | 1200 |
| 180 | F | 135D187X0010F2 | 2.2 | 40 | 1.0 | 7.0 | -36 | +14 | +16 | 1365 |
| 250 | T | 135D257X0010T2 | 1.8 | 30 | 2.0 | 10.0 | -40 | +14 | +16 | 1720 |
| 390 | T | 135D397X0010T2 | 1.5 | 25 | 2.0 | 16.0 | -64 | +17.5 | +20 | 1800 |
| 750 | K | 135D757X0010K2 | 1.0 | 23 | 4.0 | 16.0 | -80 | +25 | +25 | 2360 |
| 15 V_{DC} AT +85 °C; 10 V_{DC} AT +125 °C; 9 V_{DC} AT +200 °C | | | | | | | | | | |
| 15 | C | 135D156X0015C2 | 4.4 | 155 | 1.0 | 2.0 | -24 | +10.5 | +12 | 780 |
| 33 | C | 135D336X0015C2 | 4.0 | 90 | 1.0 | 2.0 | -28 | +14 | +16 | 820 |
| 70 | F | 135D706X0015F2 | 2.8 | 75 | 1.0 | 4.0 | -28 | +14 | +16 | 1150 |
| 120 | F | 135D127X0015F2 | 2.6 | 50 | 1.0 | 7.0 | -28 | +17.5 | +20 | 1450 |
| 170 | T | 135D177X0015T2 | 2.4 | 35 | 2.0 | 10.0 | -32 | +14 | +16 | 1480 |
| 270 | T | 135D277X0015T2 | 2.2 | 30 | 2.0 | 16.0 | -56 | +17.5 | +20 | 1740 |
| 540 | K | 135D547X0015K2 | 1.0 | 23 | 6.0 | 24.0 | -80 | +25 | +25 | 2330 |
| 25 V_{DC} AT +85 °C; 15 V_{DC} AT +125 °C; 12 V_{DC} AT +200 °C | | | | | | | | | | |
| 10 | C | 135D106X0025C2 | 5.3 | 220 | 1.0 | 2.0 | -16 | +8 | +9 | 715 |
| 22 | C | 135D226X0025C2 | 4.2 | 140 | 1.0 | 2.0 | -20 | +10.5 | +12 | 800 |
| 50 | F | 135D506X0025F2 | 3.0 | 70 | 1.0 | 2.0 | -28 | +13 | +15 | 1130 |
| 100 | F | 135D107X0025F2 | 2.8 | 50 | 1.0 | 10.0 | -28 | +13 | +15 | 1435 |
| 120 | T | 135D127X0025T2 | 2.6 | 38 | 2.0 | 6.0 | -32 | +13 | +15 | 1450 |
| 180 | T | 135D187X0025T2 | 2.2 | 32 | 2.0 | 18.0 | -48 | +13 | +15 | 1525 |
| 350 | K | 135D357X0025K2 | 1.3 | 24 | 7.0 | 28.0 | -70 | +25 | +25 | 1970 |
| 30 V_{DC} AT +85 °C; 20 V_{DC} AT +125 °C; 18 V_{DC} AT +200 °C | | | | | | | | | | |
| 8 | C | 135D805X0030C2 | 6.6 | 275 | 1.0 | 2.0 | -16 | +8 | +12 | 640 |
| 15 | C | 135D156X0030C2 | 6.2 | 175 | 1.0 | 2.0 | -20 | +10.5 | +12 | 780 |
| 22 | F | 135D226X0030F2 | 4.6 | 95 | 1.0 | 5.0 | -20 | +10.5 | +12 | 1005 |
| 40 | F | 135D406X0030F2 | 4.0 | 65 | 1.0 | 5.0 | -24 | +10.5 | +12 | 1120 |
| 68 | F | 135D686X0030F2 | 2.9 | 60 | 1.0 | 8.0 | -24 | +13 | +15 | 1285 |
| 100 | T | 135D107X0030T2 | 2.7 | 40 | 2.0 | 12.0 | -28 | +10.5 | +12 | 1450 |
| 150 | T | 135D157X0030T2 | 2.3 | 35 | 2.0 | 18.0 | -48 | +13 | +15 | 1525 |
| 300 | K | 135D307X0030K2 | 1.4 | 25 | 8.0 | 32.0 | -60 | +25 | +25 | 1950 |
| 35 V_{DC} AT +85 °C; 22 V_{DC} AT +125 °C; 21 V_{DC} AT +200 °C | | | | | | | | | | |
| 15 | C | 135D156X0035C2 | 6.2 | 175 | 0.75 | 1.5 | -20 | +10.5 | +12 | 660 |
| 68 | F | 135D686X0035F2 | 2.9 | 60 | 1.0 | 2.0 | -24 | +13 | +15 | 1195 |
| 270 | K | 135D277X0035K2 | 1.4 | 26 | 3.0 | 12.0 | -58 | +25 | +25 | 1950 |

Note

⁽¹⁾ Part numbers are for units with ± 20 % capacitance tolerance, standard +125 °C maximum temperature, standard polyesterfilm insulation, and tin-lead terminations. For other capacitance tolerances, other maximum temperatures, insulation and termination options, please consult Ordering Information on first page for proper part number



| STANDARD RATINGS | | | | | | | | | | |
|---|--------------|-----------------|--------------|--------------|----------|---------|------------------|--------|---------|------------------|
| CAPACITANCE (μ F) | CASE CODE | PART NUMBER (1) | MAX. ESR | MAX. IMP. | MAX. DCL | | MAX. CAPACITANCE | | | MAX. |
| | | | AT +25 °C | AT -55 °C | (μA) AT | | CHANGE (%) AT | | | RIPPLE |
| | | | 120 Hz | 120 Hz | +25 °C | +85 °C | -55 °C | +85 °C | +125 °C | 40 kHz |
| | | | (Ω) | (Ω) | | +125 °C | | | | I _{RMS} |
| | | | | | | | | | | (mA) |
| 50 V_{DC} AT +85 °C; 30 V_{DC} AT +125 °C; 30 V_{DC} AT +200 °C | | | | | | | | | | |
| 5 | C | 135D505X0050C2 | 8.0 | 400 | 1.0 | 2.0 | -16 | +5 | +6 | 580 |
| 10 | C | 135D106X0050C2 | 6.4 | 250 | 1.0 | 2.0 | -24 | +8 | +9 | 715 |
| 25 | F | 135D256X0050F2 | 4.6 | 95 | 1.0 | 5.0 | -20 | +10.5 | +12 | 1005 |
| 47 | F | 135D476X0050F2 | 3.7 | 70 | 1.0 | 9.0 | -28 | +13 | +15 | 1155 |
| 60 | T | 135D606X0050T2 | 2.9 | 45 | 2.0 | 12.0 | -16 | +10.5 | +12 | 1335 |
| 82 | T | 135D826X0050T2 | 2.5 | 45 | 2.0 | 16.0 | -32 | +13 | +15 | 1400 |
| 160 | K | 135D167X0050K2 | 1.5 | 27 | 8.0 | 32.0 | -50 | +25 | +25 | 1900 |
| 60 V_{DC} AT +85 °C; 40 V_{DC} AT +125 °C; 36 V_{DC} AT +200 °C | | | | | | | | | | |
| 4 | C | 135D405X0060C2 | 9.3 | 550 | 1.0 | 2.0 | -16 | +5 | +6 | 525 |
| 8.2 | C | 135D825X0060C2 | 6.6 | 275 | 1.0 | 2.0 | -24 | +8 | +9 | 625 |
| 20 | F | 135D206X0060F2 | 4.7 | 105 | 1.0 | 5.0 | -16 | +8 | +9 | 930 |
| 39 | F | 135D396X0060F2 | 3.4 | 90 | 1.0 | 9.0 | -28 | +10.5 | +15 | 1110 |
| 50 | T | 135D506X0060T2 | 2.9 | 50 | 2.0 | 12.0 | -16 | +10.5 | +12 | 1330 |
| 68 | T | 135D686X0060T2 | 2.5 | 50 | 2.0 | 16.0 | -32 | +10.5 | +15 | 1365 |
| 140 | K | 135D147X0060K2 | 1.5 | 28 | 8.0 | 32.0 | -40 | +20 | +20 | 1850 |
| 75 V_{DC} AT +85 °C; 50 V_{DC} AT +125 °C; 45 V_{DC} AT +200 °C | | | | | | | | | | |
| 3.5 | C | 135D355X0075C2 | 9.5 | 650 | 1.0 | 2.0 | -16 | +5 | +6 | 525 |
| 6.8 | C | 135D685X0075C2 | 6.8 | 300 | 1.0 | 2.0 | -20 | +8 | +9 | 610 |
| 15 | F | 135D156X0075F2 | 5.3 | 150 | 1.0 | 5.0 | -16 | +8 | +9 | 890 |
| 33 | F | 135D336X0075F2 | 4.2 | 90 | 1.0 | 10.0 | -24 | +10.5 | +15 | 1000 |
| 40 | T | 135D406X0075T2 | 3.0 | 60 | 2.0 | 12.0 | -16 | +10.5 | +12 | 1250 |
| 56 | T | 135D566X0075T2 | 2.6 | 60 | 2.0 | 17.0 | -28 | +10.5 | +15 | 1335 |
| 110 | K | 135D117X0075K2 | 1.5 | 29 | 9.0 | 36.0 | -35 | +20 | +20 | 1850 |
| 100 V_{DC} AT +85 °C; 65 V_{DC} AT +125 °C; 60 V_{DC} AT +200 °C | | | | | | | | | | |
| 2.2 | C | 135D225X0100C2 | 10.6 | 950 | 1.0 | 2.0 | -16 | +7 | +8 | 505 |
| 2.5 | C | 135D255X0100C2 | 10.6 | 950 | 1.0 | 2.0 | -16 | +7 | +8 | 505 |
| 3.9 | C | 135D395X0100C2 | 10.0 | 600 | 1.0 | 2.0 | -16 | +7 | +8 | 520 |
| 4.7 | C | 135D475X0100C2 | 8.5 | 500 | 1.0 | 2.0 | -16 | +7 | +8 | 565 |
| 11 | F | 135D116X0100F2 | 6.0 | 200 | 1.0 | 4.0 | -16 | +7 | +8 | 835 |
| 22 | F | 135D226X0100F2 | 4.8 | 100 | 1.0 | 9.0 | -16 | +7 | +8 | 965 |
| 30 | T | 135D306X0100T2 | 3.3 | 80 | 2.0 | 12.0 | -16 | +7 | +8 | 1240 |
| 43 | T | 135D436X0100T2 | 2.6 | 70 | 2.0 | 17.0 | -20 | +7 | +8 | 1335 |
| 82 | K | 135D826X0100K2 | 1.6 | 39 | 3.0 | 24 | -24 | +18 | +18 | 1860 |
| 86 | K | 135D866X0100K2 | 1.6 | 30 | 9.0 | 36.0 | -25 | +15 | +15 | 1800 |
| 125 V_{DC} AT +85 °C; 85 V_{DC} AT +125 °C; 75 V_{DC} AT +200 °C | | | | | | | | | | |
| 1.7 | C | 135D175X0125C2 | 15.6 | 1250 | 1.0 | 2.0 | -16 | +7 | +8 | 415 |
| 3.6 | C | 135D365X0125C2 | 10.0 | 600 | 1.0 | 2.0 | -16 | +7 | +8 | 520 |
| 9 | F | 135D905X0125F2 | 7.4 | 240 | 1.0 | 5.0 | -16 | +7 | +8 | 755 |
| 14 | F | 135D146X0125F2 | 5.7 | 167 | 1.0 | 7.0 | -16 | +7 | +8 | 860 |
| 18 | T | 135D186X0125T2 | 3.7 | 129 | 2.0 | 9.0 | -16 | +7 | +8 | 1130 |
| 25 | T | 135D256X0125T2 | 3.2 | 93 | 2.0 | 13.0 | -16 | +7 | +8 | 1200 |
| 56 | K | 135D566X0125K2 | 1.6 | 32 | 10.0 | 40.0 | -25 | +15 | +15 | 1800 |

Note

(1) Part numbers are for units with $\pm 20\%$ capacitance tolerance, standard +125 °C maximum temperature, standard polyesterfilm insulation, and tin-lead terminations. For other capacitance tolerances, other maximum temperatures, insulation and termination options, please consult Ordering Information on first page for proper part number



| EXTENDED RATINGS | | | | | | | | | | | |
|--|-----------|----------------------------|--------------|--------------|---------------|---------------|------------------|--------|---------|------------------|--|
| CAPACITANCE (μ F) | CASE CODE | PART NUMBER ⁽¹⁾ | MAX. ESR | MAX. IMP. | MAX. DCL | | MAX. CAPACITANCE | | | MAX. | |
| | | | AT +25 °C | AT -55 °C | (μ A) AT | CHANGE (%) AT | | | RIPPLE | | |
| | | | 120 Hz | 120 Hz | +25 °C | +85 °C | -55 °C | +85 °C | +125 °C | 40 kHz | |
| | | | (Ω) | (Ω) | | +125 °C | | | | I _{RMS} | |
| | | | | | | | | | | (mA) | |
| 6 V_{DC} AT +85 °C; 4 V_{DC} AT +125 °C; 3.6 V_{DC} AT +200 °C | | | | | | | | | | | |
| 220 | C | 135D227X0006C2 | 3.0 | 36 | 2.0 | 9.0 | -64 | +13 | +16 | 1000 | |
| 560 | F | 135D567X0006F2 | 2.5 | 21 | 3.0 | 9.0 | -77 | +16 | +20 | 1500 | |
| 820 | F | 135D827X0006F2 | 2.5 | 18 | 3.0 | 14 | -88 | +16 | +20 | 1500 | |
| 1200 | T | 135D128X0006T2 | 1.5 | 18 | 5.0 | 18.0 | -88 | +20 | +25 | 1900 | |
| 1500 | T | 135D158X0006T2 | 1.5 | 18 | 5.0 | 20.0 | -90 | +20 | +25 | 1900 | |
| 2200 | K | 135D228X0006K2 | 1.0 | 13 | 6.0 | 24.0 | -90 | +25 | +30 | 2300 | |
| 8 V_{DC} AT +85 °C; 5 V_{DC} AT +125 °C; 4.8 V_{DC} AT +200 °C | | | | | | | | | | | |
| 180 | C | 135D187X0008C2 | 3.0 | 45 | 2.0 | 9.0 | -60 | +13 | +16 | 1000 | |
| 680 | F | 135D687X0008F2 | 2.5 | 22 | 3.0 | 14.0 | -83 | +16 | +20 | 1500 | |
| 1500 | T | 135D158X0008T2 | 1.5 | 18 | 5.0 | 20.0 | -90 | +20 | +25 | 1900 | |
| 1800 | K | 135D188X0008K2 | 1.0 | 14 | 7.0 | 25.0 | -90 | +25 | +30 | 2300 | |
| 10 V_{DC} AT +85 °C; 7 V_{DC} AT +125 °C; 6 V_{DC} AT +200 °C | | | | | | | | | | | |
| 120 | C | 135D127X0010C2 | 3.2 | 54 | 2.0 | 6.0 | -40 | +14 | +16 | 900 | |
| 150 | C | 135D157X0010C2 | 3.0 | 54 | 2.0 | 9.0 | -55 | +13 | +16 | 900 | |
| 390 | F | 135D397X0010F2 | 2.5 | 27 | 3.0 | 9.0 | -66 | +16 | +20 | 1470 | |
| 470 | F | 135D477X0010F2 | 2.5 | 27 | 3.0 | 16.0 | -66 | +16 | +20 | 1450 | |
| 560 | F | 135D567X0010F2 | 2.5 | 27 | 3.0 | 16.0 | -77 | +16 | +20 | 1450 | |
| 1200 | T | 135D128X0010T2 | 1.5 | 18 | 5.0 | 20.0 | -88 | +20 | +25 | 1850 | |
| 1500 | K | 135D158X0010K2 | 1.0 | 15 | 7.0 | 25.0 | -88 | +25 | +30 | 2300 | |
| 15 V_{DC} AT +85 °C; 10 V_{DC} AT +125 °C; 9 V_{DC} AT +200 °C | | | | | | | | | | | |
| 82 | C | 135D826X0015C2 | 3.9 | 72 | 2.0 | 6.0 | -35 | +12 | +16 | 900 | |
| 100 | C | 135D107X0015C2 | 3.9 | 72 | 2.0 | 9.0 | -44 | +13 | +16 | 900 | |
| 270 | F | 135D277X0015F2 | 2.5 | 31 | 3.0 | 9.0 | -62 | +16 | +15 | 1450 | |
| 390 | F | 135D397X0015F2 | 2.5 | 31 | 3.0 | 16.0 | -66 | +16 | +20 | 1450 | |
| 680 | T | 135D687X0015T2 | 1.8 | 22 | 6.0 | 18.0 | -74 | +20 | +25 | 1800 | |
| 820 | T | 135D827X0015T2 | 1.8 | 22 | 6.0 | 24.0 | -77 | +20 | +25 | 1800 | |
| 1000 | K | 135D108X0015K2 | 1.2 | 17 | 8.0 | 32.0 | -77 | +25 | +30 | 2330 | |
| 25 V_{DC} AT +85 °C; 15 V_{DC} AT +125 °C; 12 V_{DC} AT +200 °C | | | | | | | | | | | |
| 47 | C | 135D476X0025C2 | 5.2 | 100 | 2.0 | 6.0 | -23 | +12 | +15 | 800 | |
| 56 | C | 135D566X0025C2 | 4.3 | 90 | 2.0 | 6.0 | -25 | +12 | +15 | 850 | |
| 68 | C | 135D686X0025C2 | 4.3 | 90 | 2.0 | 9.0 | -40 | +12 | +15 | 850 | |
| 180 | F | 135D187X0025F2 | 2.7 | 33 | 3.0 | 9.0 | -54 | +13 | +15 | 1400 | |
| 270 | F | 135D277X0025F2 | 2.7 | 33 | 3.0 | 16.0 | -62 | +13 | +16 | 1400 | |
| 390 | T | 135D397X0025T2 | 1.8 | 25 | 6.0 | 18.0 | -55 | +18 | +25 | 1500 | |
| 470 | T | 135D477X0025T2 | 1.8 | 24 | 6.0 | 18.0 | -65 | +18 | +25 | 1750 | |
| 560 | T | 135D567X0025T2 | 1.8 | 24 | 7.0 | 28.0 | -72 | +20 | +25 | 1750 | |
| 680 | K | 135D687X0025K2 | 1.2 | 19 | 8.0 | 32.0 | -72 | +25 | +30 | 2100 | |
| 820 | K | 135D827X0025K2 | 1.3 | 26 | 8.0 | 32.0 | -80 | +25 | +25 | 2100 | |
| 30 V_{DC} AT +85 °C; 20 V_{DC} AT +125 °C; 18 V_{DC} AT +200 °C | | | | | | | | | | | |
| 47 | C | 135D476X0030C2 | 5.2 | 100 | 2.0 | 6.0 | -23 | +12 | +15 | 800 | |
| 56 | C | 135D566X0030C2 | 5.2 | 100 | 2.0 | 9.0 | -38 | +12 | +15 | 800 | |
| 150 | F | 135D157X0030F2 | 2.5 | 36 | 3.0 | 9.0 | -42 | +13 | +15 | 1200 | |
| 220 | F | 135D227X0030F2 | 2.5 | 36 | 3.0 | 16.0 | -60 | +13 | +16 | 1200 | |
| 300 | T | 135D307X0030T2 | 2.2 | 44 | 3.0 | 12.0 | -60 | +15 | +15 | 1559 | |
| 390 | T | 135D397X0030T2 | 1.8 | 25 | 6.0 | 18.0 | -55 | +18 | +25 | 1500 | |
| 470 | T | 135D477X0030T2 | 1.8 | 25 | 8.0 | 32.0 | -65 | +20 | +25 | 1500 | |
| 560 | K | 135D567X0030K2 | 1.3 | 20 | 9.0 | 36.0 | -65 | +25 | +30 | 2000 | |
| 35 V_{DC} AT +85 °C; 22 V_{DC} AT +125 °C; 21 V_{DC} AT +200 °C | | | | | | | | | | | |
| 39 | C | 135D396X0035C2 | 4.1 | 61 | 2.0 | 6.0 | -22 | +12 | +14 | 820 | |
| 120 | F | 135D127X0035F2 | 2.5 | 31 | 3.0 | 10.0 | -40 | +13 | +15 | 1315 | |
| 330 | T | 135D337X0035T2 | 1.8 | 20 | 6.0 | 18.0 | -50 | +16 | +25 | 1640 | |
| 370 | K | 135D377X0035K2 | 1.3 | 15 | 9.0 | 36.0 | -60 | +25 | +30 | 2040 | |

Note

(1) Part numbers are for units with \pm 20 % capacitance tolerance, standard +125 °C maximum temperature, standard polyesterfilm insulation, and tin-lead terminations. For other capacitance tolerances, other maximum temperatures, insulation and termination options, please consult Ordering Information on first page for proper part number



| EXTENDED RATINGS | | | | | | | | | | | |
|---|-----------|-----------------|--------------|--------------|---------------|---------------|------------------|--------|---------|------------------|--|
| CAPACITANCE (μ F) | CASE CODE | PART NUMBER (1) | MAX. ESR | MAX. IMP. | MAX. DCL | | MAX. CAPACITANCE | | | MAX. RIPPLE | |
| | | | AT +25 °C | AT -55 °C | (μ A) AT | CHANGE (%) AT | | | 40 kHz | | |
| | | | 120 Hz | 120 Hz | +25 °C | +85 °C | -55 °C | +85 °C | +125 °C | I _{RMS} | |
| | | | (Ω) | (Ω) | | +125 °C | | | | (mA) | |
| 40 V_{DC} AT +85 °C; 25 V_{DC} AT +125 °C; 20 V_{DC} AT +200 °C | | | | | | | | | | | |
| 39 | C | 135D396X0040C2 | 4.1 | 61 | 2.0 | 6.0 | -22 | +12 | +14 | 820 | |
| 220 | K | 135D227X0040K2 | 1.6 | 27 | 3.0 | 22.0 | -58 | +23 | +23 | 1900 | |
| 370 | K | 135D377X0040K2 | 1.5 | 30 | 5.0 | 25.0 | -75 | +25 | +25 | 1900 | |
| 470 | K | 135D477X0040K2 | 1.3 | 30 | 9.0 | 35.0 | -80 | +25 | +25 | 2040 | |
| 50 V_{DC} AT +85 °C; 30 V_{DC} AT +125 °C; 30 V_{DC} AT +200 °C | | | | | | | | | | | |
| 33 | C | 135D336X0050C2 | 5.0 | 135 | 2.0 | 9.0 | -29 | +10 | +12 | 700 | |
| 100 | F | 135D107X0050F2 | 2.8 | 49 | 4.0 | 12.0 | -36 | +13 | +15 | 1200 | |
| 120 | F | 135D127X0050F2 | 2.5 | 49 | 4.0 | 24.0 | -42 | +12 | +15 | 1200 | |
| 270 | T | 135D277X0050T2 | 2.0 | 30 | 8.0 | 32.0 | -46 | +20 | +25 | 1450 | |
| 330 | K | 135D337X0050K2 | 1.5 | 30 | 9.0 | 36.0 | -46 | +25 | +30 | 1900 | |
| 60 V_{DC} AT +85 °C; 40 V_{DC} AT +125 °C; 36 V_{DC} AT +200 °C | | | | | | | | | | | |
| 18 | C | 135D186X0060C2 | 7.0 | 160 | 2.0 | 12.0 | -20 | +7 | +8 | 700 | |
| 27 | C | 135D276X0060C2 | 5.0 | 144 | 3.0 | 12.0 | -24 | +10 | +12 | 700 | |
| 82 | F | 135D826X0060F2 | 2.9 | 54 | 4.0 | 16.0 | -30 | +15 | +15 | 1100 | |
| 100 | F | 135D107X0060F2 | 2.5 | 54 | 4.0 | 20.0 | -36 | +12 | +15 | 1100 | |
| 220 | T | 135D227X0060T2 | 1.8 | 29 | 8.0 | 32.0 | -40 | +16 | +20 | 1400 | |
| 270 | K | 135D277X0060K2 | 1.4 | 23 | 9.0 | 36.0 | -45 | +20 | +25 | 1850 | |
| 330 | K | 135D337X0060K2 | 1.3 | 31 | 10.0 | 40.0 | -72 | +25 | +25 | 1850 | |
| 63 V_{DC} AT +85 °C; 40 V_{DC} AT +125 °C; 31 V_{DC} AT +200 °C | | | | | | | | | | | |
| 10 | C | 135D106X0063C2 | 5.3 | 250 | 1.0 | 2.0 | -20 | +8 | +9 | 715 | |
| 27 | C | 135D276X0063C2 | 5.0 | 144 | 3.0 | 12.0 | -24 | +10 | +12 | 700 | |
| 100 | F | 135D107X0063F2 | 2.5 | 54 | 2.0 | 12.0 | -36 | +12 | +15 | 1100 | |
| 75 V_{DC} AT +85 °C; 50 V_{DC} AT +125 °C; 45 V_{DC} AT +200 °C | | | | | | | | | | | |
| 5.6 | C | 135D565X0075C2 | 14.2 | 475 | 2.0 | 5.0 | -17 | +8 | +8 | 600 | |
| 12 | C | 135D126X0075C2 | 5.1 | 157 | 3.0 | 12.0 | -19 | +10 | +12 | 600 | |
| 22 | C | 135D226X0075C2 | 5.1 | 157 | 3.0 | 12.0 | -19 | +10 | +12 | 600 | |
| 68 | F | 135D686X0075F2 | 3.0 | 63 | 4.0 | 16.0 | -25 | +12 | +15 | 1000 | |
| 82 | F | 135D826X0075F2 | 2.5 | 63 | 4.0 | 24.0 | -30 | +12 | +15 | 1000 | |
| 110 | F | 135D117X0075F2 | 2.5 | 54 | 4.0 | 20.0 | -36 | +12 | +15 | 1100 | |
| 180 | T | 135D187X0075T2 | 2.2 | 30 | 9.0 | 36.0 | -35 | +16 | +20 | 1300 | |
| 200 | K | 135D207X0075K2 | 1.8 | 24 | 10.0 | 40.0 | -40 | +20 | +25 | 1800 | |
| 220 | K | 135D227X0075K2 | 1.8 | 24 | 10.0 | 40.0 | -40 | +20 | +25 | 1800 | |
| 300 | K | 135D307X0075K2 | 1.8 | 32 | 12.0 | 48.0 | -60 | +22 | +22 | 2000 | |
| 100 V_{DC} AT +85 °C; 65 V_{DC} AT +125 °C; 60 V_{DC} AT +200 °C | | | | | | | | | | | |
| 5.6 | C | 135D565X0100C2 | 14 | 475 | 2.0 | 5.0 | -17 | +8 | +8 | 565 | |
| 10 | C | 135D106X0100C2 | 5.9 | 200 | 3.0 | 12.0 | -17 | +10 | +12 | 800 | |
| 39 | F | 135D396X0100F2 | 3.5 | 80 | 5.0 | 24.0 | -20 | +12 | +15 | 1300 | |
| 47 | T | 135D476X0100T2 | 2.5 | 70 | 2.0 | 10.0 | -23 | +10 | +10 | 1390 | |
| 56 | T | 135D566X0100T2 | 2.4 | 50 | 5.0 | 20.0 | -25 | +12 | +12 | 1400 | |
| 68 | T | 135D686X0100T2 | 2.2 | 40 | 10.0 | 40.0 | -30 | +14 | +16 | 1600 | |
| 120 | K | 135D127X0100K2 | 2.7 | 30 | 12.0 | 48.0 | -35 | +15 | +17 | 2000 | |
| 125 V_{DC} AT +85 °C; 85 V_{DC} AT +125 °C; 75 V_{DC} AT +200 °C | | | | | | | | | | | |
| 3.9 | C | 135D395X0125C2 | 20.4 | 557 | 2.0 | 5.0 | -16 | +7 | +8 | 495 | |
| 6.8 | C | 135D685X0125C2 | 11.7 | 300 | 3.0 | 12.0 | -14 | +10 | +12 | 700 | |
| 15 | F | 135D156X0125F2 | 5.3 | 167 | 1.0 | 7.0 | -16 | +7 | +8 | 1200 | |
| 27 | F | 135D276X0125F2 | 3.5 | 90 | 5.0 | 24.0 | -18 | +12 | +15 | 1200 | |
| 47 | T | 135D476X0125T2 | 2.2 | 50 | 10.0 | 40.0 | -26 | +14 | +16 | 1500 | |
| 56 | T | 135D566X0125T2 | 2.2 | 50 | 10.0 | 40.0 | -26 | +14 | +16 | 1500 | |
| 68 | K | 135D686X0125K2 | 2.2 | 32 | 11.0 | 44.0 | -28 | +15 | +16 | 1850 | |
| 82 | K | 135D826X0125K2 | 2.8 | 32 | 12.0 | 48.0 | -30 | +15 | +17 | 1900 | |

Note

(1) Part numbers are for units with $\pm 20\%$ capacitance tolerance, standard +125 °C maximum temperature, standard polyesterfilm insulation, and tin-lead terminations. For other capacitance tolerances, other maximum temperatures, insulation and termination options, please consult Ordering Information on first page for proper part number

TYPICAL CURVES OF IMPEDANCE AS A FUNCTION OF FREQUENCY AT VARIOUS TEMPERATURES

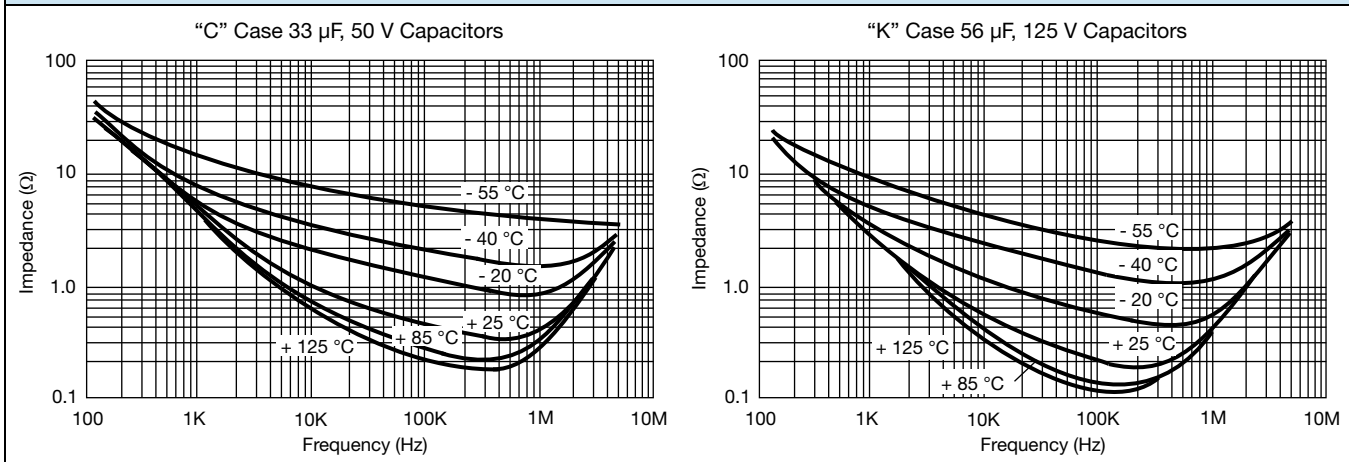

PERFORMANCE CHARACTERISTICS

1. **Operating Temperature:** capacitors are designed to operate over a temperature range of -55 °C to +200 °C.

| UP TO +85 °C (V) | AT +125 °C (V) | AT +200 °C (V) |
|------------------------|----------------------|----------------------|
| 6 | 4 | 3.6 |
| 8 | 5 | 4.8 |
| 10 | 7 | 6 |
| 15 | 10 | 9 |
| 25 | 15 | 12 |
| 30 | 20 | 18 |
| 35 | 22 | 21 |
| 40 | 25 | 20 |
| 50 | 30 | 30 |
| 60 | 40 | 36 |
| 63 | 40 | 31 |
| 75 | 50 | 45 |
| 100 | 65 | 60 |
| 125 | 85 | 75 |

2. **DC Working Voltage:** the DC working voltage is the maximum operating voltage for continuous duty at the rated temperature.

3. **Surge Voltage:** the surge voltage rating is the maximum voltage to which the capacitors should be subjected under any conditions. This includes transients and peak ripple at the highest line voltage.

3.1 The surge voltage of capacitors is 115 % of rated DC working voltage.

3.2 **Surge Voltage Test:** capacitors shall withstand the surge voltage applied through a 1000 Ω ± 10 % resistor in series with the capacitor and voltage source at the rate of one-half minute on, four and one-half minutes off, for 1000 successive test cycles at +85 °C or +125 °C.

3.3 Following the surge voltage test, the capacitance at +25 °C shall not have changed by more than ± 10 % and the equivalent series resistance and DC leakage current will not exceed the values shown in the Standard Ratings table for each capacitor.

4. **Capacitance Tolerance:** the capacitance of all capacitors shall be within the specified tolerance limits of the nominal rating.

4.1 Measurements shall be made by the bridge method at or referred to a frequency of 120 Hz at a temperature of +25 °C. The maximum voltage applied to the capacitors during measurement shall be 1 V_{RMS}. Measurement accuracy of the bridge shall be within ± 2 %.

5. **Capacitance Change With Temperature:** the capacitance change with temperature shall not exceed the values given in the Standard Ratings table for each capacitor.

6. **Equivalent Series Resistance:** measurements shall be made by the bridge method at, or referred to, a frequency of 120 Hz at a temperature of +25 °C. A maximum of 1 V_{RMS} shall be applied during measurement.

6.1 The equivalent series resistance shall not exceed the maximum value in ohms listed in the Standard Ratings table for each capacitor.

6.2 The dissipation factor may be calculated from the equivalent series resistance and capacitance values as shown:

$$DF = \frac{2\pi fRC}{10^4}$$

where:

DF = dissipation factor in %

R = ESR in Ω

C = capacitance in μF

f = frequency in Hz

At 120 Hz, the above equation becomes:

$$DF = \frac{R \times C}{13.26}$$

For example, percent dissipation factor of a 30 μF , 6 V capacitor, which has a maximum ESR of 4.0 Ω at +25 °C and 120 Hz, would be calculated as shown:

$$DF = \frac{2\pi \times 120 \times 4 \times 30}{10^4} = \frac{4 \times 30}{13.26} = 9.05 \%$$

7. **Leakage Current:** measurements shall be made at the applicable rated working voltage at +25 °C \pm 5 °C through application of a steady source of power, such as a regulated power supply. A 1000 Ω resistor to limit the charging current shall be connected in series with each capacitor under test. Rated working voltage shall be applied to capacitors for 5 minutes before making leakage current measurements.

7.1 The maximum leakage current for any capacitor shall not exceed the maximum value in microamperes listed in the Standard Ratings and Extended Ratings table for each capacitor.

Note

- Leakage current varies with applied voltage. See graph next column for the appropriate adjustment factor

8. **Low Temperature Impedance:** the impedance of any capacitor at -55 °C at 120 Hz, shall not exceed the values given in the Standard Ratings and Extended Ratings tables.

9. **Life Test:** capacitors are capable of withstanding a life test at a temperature of +85 °C, or +125 °C, or +175 °C, or +200 °C at the applicable DC working voltage:

| TEMPERATURE | DURATION HOURS | TEST VOLTAGE (% OF RATED VOLTAGE) |
|------------------------|----------------|-----------------------------------|
| +85 °C | 2000 | 100 |
| +125 °C | 2000 | 67 |
| +175 °C (style 6 or 8) | 2000 | 50 |
| +175 °C (style 6 or 8) | 300 | 65 |
| +200 °C (style 6 or 8) | 300 | 60 |

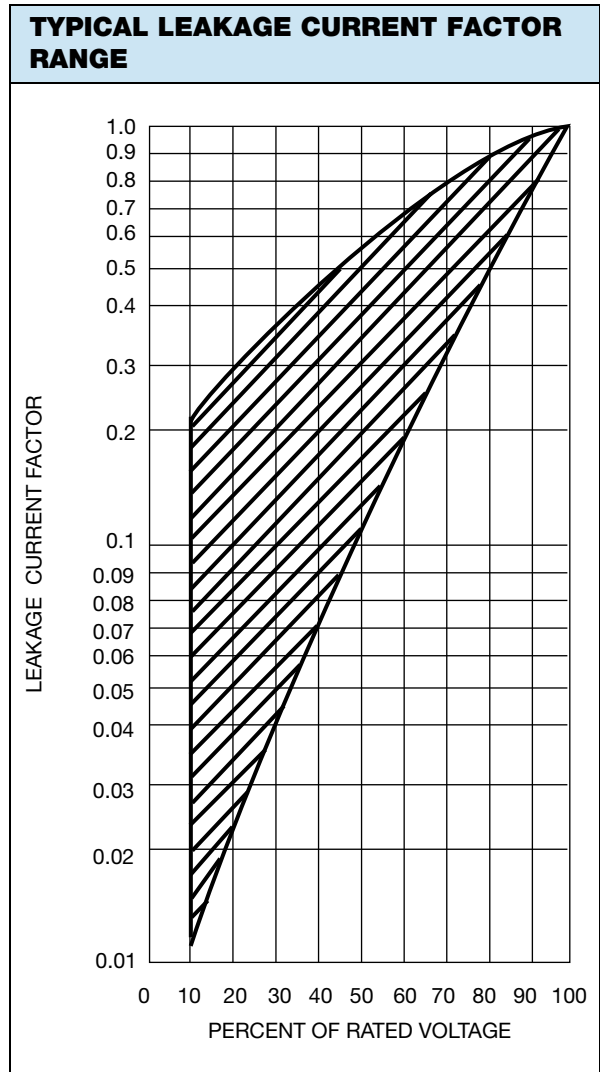

9.1 Following the life test, the capacitors shall be returned to 25 °C \pm 5 °C.

9.2 Following life test +85 °C or +125 °C: the leakage current, measured at full rated voltage, shall not be in excess of the initial requirement; the equivalent series resistance value shall not exceed 150 % of the initial requirement; the capacitance value shall not change more than 10 % from the initial measurement.

9.3 Following life test +175 °C or +200 °C: the leakage current, measured at full rated voltage shall not exceed 200 % of the initial requirement or 10 μA , whichever is greater; the equivalent series resistance shall not be greater than 200 % of the initial requirement; the capacitance value shall not change by more than +10 % / -20 % from the initial measurement.



10. **Ripple Life Test at +85 °C:** capacitors shall be tested in accordance with Military Specification MIL-PRF-39006 except that:
 - a) Operation conditions: this test shall be run at a frequency of 40 kHz \pm 2 kHz sinusoidal and at the RMS ripple current levels specified in the Standard Ratings and Extended Ratings table.
 - b) Applied DC voltage shall be reduced so that the peak AC voltage plus DC voltage shall not exceed the rated voltage of the capacitor in either the forward or reverse direction.
- 10.1 When tested as specified above, capacitors shall meet the following requirements:
 - a) The DC leakage current at +25 °C and at +85 °C shall not exceed the original requirements.
 - b) The capacitance shall not change more than \pm 15 % from the initial measured value.
 - c) The dissipation factor shall not exceed the original requirements.
 - d) Visual examination: there shall be no damage, obliteration of marking or leakage of electrolyte.
11. **Reverse Voltage Test:** capacitors shall withstand a reverse voltage of 3 V_{DC} at +85 °C or 2 V at +125 °C for 2000 h. The capacitors shall then be restabilized for 24 h at 85 °C with rated DC forward potential applied through a 1000 Ω resistor.
- 11.1 Following the reverse voltage test, the DC leakage current shall not be in excess of the original requirement; the equivalent series resistance shall not exceed 200 % of the initial requirement; the capacitance value shall not be less than 90 % of the initial measurement.
12. **Mechanical Shock Test:** capacitors shall withstand a shock of 500 g when tested in accordance with method 213 of MIL-STD-202, test condition D.
- 12.1 Following the mechanical shock test, capacitors shall be examined for evidence of mechanical damage and leakage of electrolyte. Capacitance, equivalent series resistance, and DC leakage current shall meet the initial requirements.
13. **High Frequency Vibration:** capacitors shall withstand vibration from 10 Hz to 2000 Hz at 80 g without internal damage when tested in accordance with MIL-STD-202, method 204, test condition H. Electrical measurements made while under these conditions shall show no intermittent contacts, open circuits or short circuits.
- 13.1 Capacitors shall be securely fastened by means of suitable component clips or brackets.
14. **Random Vibration:** capacitors shall withstand random vibration at all levels up to 51 g RMS overall when tested in accordance with MIL-STD-202, method 214, test condition II K. The test shall be conducted for 1.5 h in each of three mutually perpendicular directions.
- 14.1 Electrical measurements made during the test shall show no intermittent contacts, open circuits or short circuits.
15. **Pull Test:** leads shall withstand a tensile stress of 3 lbs. (1.4 kg) for 30 s applied axially in accordance with MIL-STD-202, method 211, test condition A.
16. **Lead Bend Test:** leads shall meet the bend test specified in Military Standard MIL-STD-202, method 211 A, condition C except that the number of bends shall be 4.
17. **Moisture Resistance:** capacitors shall withstand the moisture resistance cycling test specified in Military Standard MIL-STD-202, method 106, without departure from the original limits of capacitance, equivalent series resistance and DC leakage current.
18. **Reduced Pressure:** capacitors shall be stabilized at a reduced atmospheric pressure of 0.82" [20.83 mm] of mercury for a period of 5 min. Rated DC voltage shall be applied for 1 min. Capacitors shall not flash over nor shall end seals be damaged by this nor should the capacitors be electrically effected insofar as capacitance, equivalent series resistance or leakage current is concerned.
19. **Seal Test:**
 - 19.1 Capacitors shall be tested in accordance with MIL-STD-202, method 112, test condition C, procedure IIIa. Specimens shall be pressurized at 4 atmospheres (gage) for 4 h.
20. **Thermal Shock:** capacitors shall be subjected to 300 cycles of thermal shock in accordance with Military specification MIL-PRF-39006.
- 20.1 Following the thermal shock test, capacitor leakage current shall not exceed twice the initial requirement.
21. **Marking:** capacitors shall be marked with Vishay identification; capacitors type (135D); rated capacitance and tolerance (the tolerance shall be coded, using the list shown in How to Order); rated DC working voltage at +85 °C; the standard EIA date code of manufacture.
- 21.1 Polarity shall be indicated by plus signs (+) adjacent to the positive terminal.

GUIDE TO APPLICATION

1. **AC Ripple Current:** subjecting a capacitor to an AC voltage causes an AC current to flow through it. The amplitude of the current is dependent on the impedance of the capacitor at the frequency of the applied signal:

$$I = \frac{V}{Z}$$

where:

I = ripple current

V = applied AC voltage

Z = impedance of capacitor (frequency dependent)

This current causes heating in the capacitor because of I^2R losses (R is the equivalent series resistance at the applied frequency). This heating or power dissipation, is one of the limiting factors of the capacitor's ripple current rating.

| CASE CODE | MAXIMUM PERMISSIBLE POWER DISSIPATION AT +25 °C (W) IN FREE AIR |
|-----------|---|
| C | 1.00 |
| F | 1.55 |
| T | 1.75 |
| K | 1.95 |

These power dissipation ratings are based on a calculated +50 °C internal temperature rise in still air. The maximum allowable ripple currents given in the Standard and Extended Ratings tables are based on these ratings and the maximum equivalent series resistance at that frequency.

The relationship is written as follows:

$$P = I^2R$$

where:

P = maximum power

I = maximum ripple current

R = equivalent series resistance

Therefore:

$$I = \sqrt{\frac{P}{R}}$$

where:

R is in Ω

P is in W

I is in A_{RMS}

2. **AC Ripple Voltage:** in operation, the peak voltage across the capacitor (DC working voltage plus peak ripple voltage) must not exceed the rated working voltage of the capacitor. The DC component of the applied voltage should be sufficiently large to prevent polarity reversal in excess of 3 V at +85 °C or 2 V at 125 °C.

There will be a point at the lower frequency and capacitance values when the peak AC voltage will be the limiting factor on the ripple current - not its heating effects.

For example:

given a 25 μ F, 8 V capacitor in the "C" case code and assuming a ripple current application at a frequency of 120 Hz, the total maximum allowable peak to peak voltage at +25 °C is:

$$8 V_F + 3 V_R = 11 V_{pp}$$

In order to allow the full swing of 11 V_{pp} and not exceed rated forward or rated reverse, a DC bias of 2.5 V is assumed to be applied.

From the "Standard Ratings Table", the maximum ripple current at 40 kHz is 0.820 A. Compensating for the lower frequency from the "Ripple Current Multipliers" tables:

$$I_{RMS} (120 \text{ Hz}) = 0.820 \text{ A} \times 0.6 = 0.492 A_{RMS}$$

This current rating is calculated strictly on the basis of maximum power dissipation. Now calculate what impressed voltage this amount of current will cause across this capacitor.

Assuming a sinusoidal voltage, calculate the rated peak to peak current:

$$I_{pp} = (I_{RMS} \times 2\sqrt{2}) = 0.492 \times 2.828 = 1.39 A_{pp}$$

$$V_{pp(\text{impressed})} = (I_{pp} \times Z_C) (120 \text{ Hz})$$

where:

$$Z_{C(120\text{Hz})} = \left(\sqrt{(ESR)^2 + (X_{C(120\text{Hz})})^2} \right)^2$$

ESR = 4 Ω (from "Standard Ratings" table)

$$X_C = \frac{1}{2\pi f C} = \frac{1}{2(\pi)(120)(25 \times 10^{-6})} = 53.1 \Omega$$

Therefore:

$$Z_C = \sqrt{(4)^2 + (53.1)^2} = 53.3 \Omega$$

and

$$\begin{aligned} V_{pp(\text{impressed})} &= 1.39 (A_{pp} \times 53.3 \Omega) \\ &= 74.1 V_{pp} > 11 V_{pp} \end{aligned}$$

Therefore, the peak voltage of the capacitor is the limiting factor for the ripple current and can be calculated as follows:

$$\text{Max. } I_{pp} = \frac{V_{Cdp}(\text{allowed})}{Z_C} = \frac{11.0 \text{ V}}{53.3 \Omega} = 0.206 A_{pp}$$

or

$$\frac{0.206}{2\sqrt{2}} = 0.073 A_{RMS} \text{ at } 120 \text{ Hz}$$

Verifying that the 40 kHz rating does not exceed the peak voltage limitations:

$$I_{\text{rated}} = 0.820 A_{\text{RMS}}$$

$$I_{\text{pp(rated)}} = 0.820 \times 2\sqrt{2} = 2.32 A_{\text{pp}}$$

$$Z_{\text{C (40 kHz)}} = \left(\sqrt{(\text{ESR}_{(40 \text{ kHz})})^2 + (X_{\text{C(40 Hz)}})^2} \right)$$

where:

$$\text{ESR}_{(40 \text{ kHz})} = 4 \Omega_{(120 \text{ Hz})} \times 0.34$$

(from Extended Ratings table) = 1.36 Ω

and:

$$X_{\text{C (40 kHz)}} = \frac{1}{2\pi fC}$$

$$= \frac{1}{2\pi \times (40 \times 10^3) \times (25 \times 10^{-6})} = 0.159 \Omega$$

thus:

$$Z_{\text{C (40kHz)}} = \sqrt{(1.36)^2 + (0.159)^2} = 1.37 \Omega$$

Therefore the impressed voltage is:

$$V_{\text{Cpp}} = Z_{\text{Cpp}} I_{\text{pp}} = 1.37 \Omega \times 2.32 A_{\text{pp}} = 3.18 V_{\text{pp}}$$

and:

$$3.18 V < 11 V$$

Therefore, if the capacitor is biased between -1.41 V_{DC} and +6.41 V_{DC} , it can withstand the rated ripple current, which is based only on the maximum allowable power dissipation.

3. **Ripple Current Multipliers:** the “Standard and Extended Ratings” tables list the maximum permissible RMS ripple current at 40 kHz for each rating (at +85°C and with maximum 67% of DC rated voltage applied). These values are based on the maximum power dissipation allowed at that frequency.

This ripple current will cause heating, which adds to the ambient temperature. With higher ambient temperatures and various levels of DC voltage derating, ripple current derating is required (see “Ripple Current Multipliers” tables). Also shown are the ripple current multipliers at various frequencies, caused by the frequency dependence of the ESR (equivalent series resistance). Below is “Typical ESR as Function of Frequency” chart.

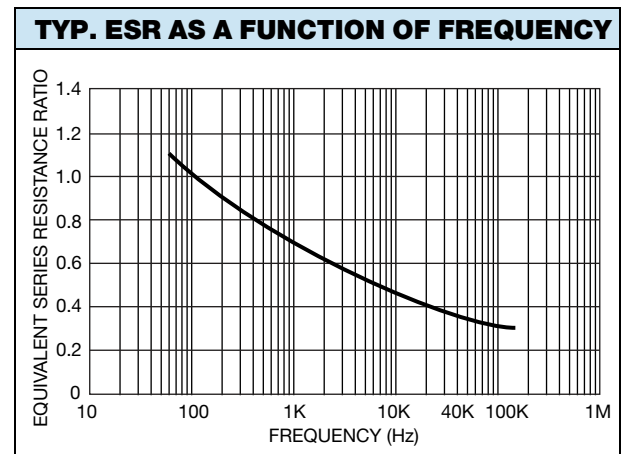

| RIPPLE CURRENT MULTIPLIERS (120 Hz to 1 kHz) | | | | | | | | | |
|--|----------------------------|--------|---------|----------|--------|---------|----------|--------|---------|
| % OF +85 °C RATED PEAK VOLTAGE | RIPPLE CURRENT MULTIPLIERS | | | | | | | | |
| | 120 Hz | | | 800 Hz | | | 1 kHz | | |
| | ≤ +55 °C | +85 °C | +125 °C | ≤ +55 °C | +85 °C | +125 °C | ≤ +55 °C | +85 °C | +125 °C |
| 100 | 0.60 | 0.39 | - | 0.71 | 0.43 | - | 0.72 | 0.45 | - |
| 90 | 0.60 | 0.46 | - | 0.71 | 0.55 | - | 0.72 | 0.55 | - |
| 80 | 0.60 | 0.52 | - | 0.71 | 0.62 | - | 0.72 | 0.62 | - |
| 70 | 0.60 | 0.58 | - | 0.71 | 0.69 | - | 0.72 | 0.70 | - |
| ≤ 67 | 0.60 | 0.60 | 0.27 | 0.71 | 0.71 | 0.32 | 0.72 | 0.72 | 0.32 |

| RIPPLE CURRENT MULTIPLIERS (10 kHz to 100 kHz) | | | | | | | | | |
|--|----------------------------|--------|---------|----------|--------|---------|----------|--------|---------|
| % OF +85 °C RATED PEAK VOLTAGE | RIPPLE CURRENT MULTIPLIERS | | | | | | | | |
| | 10 kHz | | | 40 kHz | | | 100 kHz | | |
| | ≤ +55 °C | +85 °C | +125 °C | ≤ +55 °C | +85 °C | +125 °C | ≤ +55 °C | +85 °C | +125 °C |
| 100 | 0.88 | 0.55 | - | 1.0 | 0.63 | - | 1.1 | 0.69 | - |
| 90 | 0.88 | 0.67 | - | 1.0 | 0.77 | - | 1.1 | 0.85 | - |
| 80 | 0.88 | 0.76 | - | 1.0 | 0.87 | - | 1.1 | 0.96 | - |
| 70 | 0.88 | 0.85 | - | 1.0 | 0.97 | - | 1.1 | 1.07 | - |
| ≤ 67 | 0.88 | 0.88 | 0.40 | 1.0 | 1.0 | 0.45 | 1.1 | 1.1 | 0.50 |

4. **Storage Life:** a storage life of 10 years or more, with no voltage at room temperature, may be expected.

5. **Series Operation:** these capacitors may be used in some series applications. For such an application to achieve a high voltage rating (e.g. 28 μF , 250 V using two 56 μF , 125 V capacitors), a suitable balancing network of resistors in parallel with the capacitors is required to evenly distribute the voltage across each capacitor. The value of the appropriate resistor will be dependent on the DC leakage current of the capacitors and, as recommended value, it should be selected to allow a current equal to 10 times the DC leakage current limit (see Standard Ratings and Extended Ratings table at the appropriate temperature) to flow parallel to each capacitor.

For example:

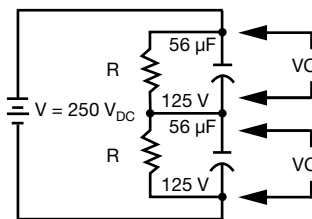

For example:

$$R = \frac{V_C}{10 I_{DCL}} = \frac{125 \text{ V}}{200 (\mu\text{A})} = 625 \text{ k}\Omega$$

where:

V_C = voltage across capacitor

I_{DCL} = DC leakage current at +85 °C from Standard Ratings and Extended Ratings table

6. **Special Applications:** Vishay product specialists will, on request, furnish recommendations for your particular application.

TYPICAL CURVES OF IMPEDANCE, AS A FUNCTION OF FREQUENCY

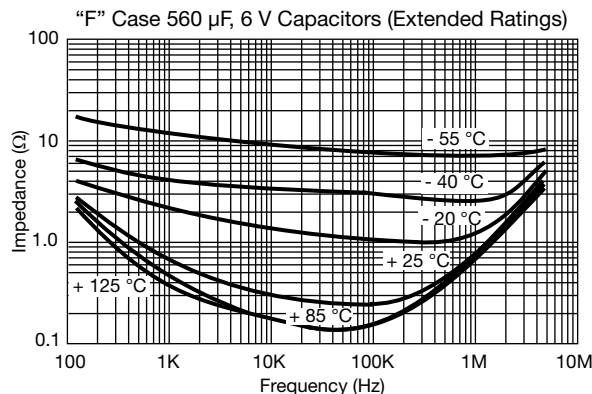
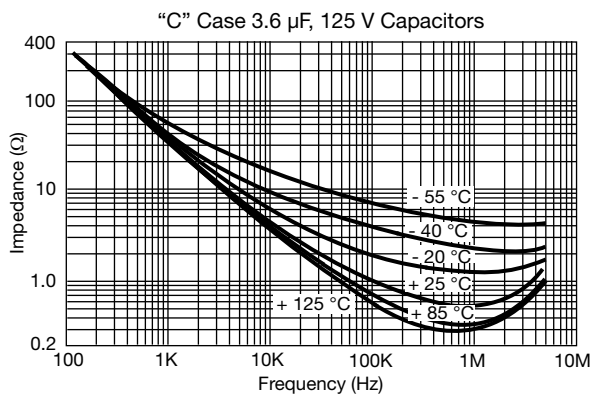
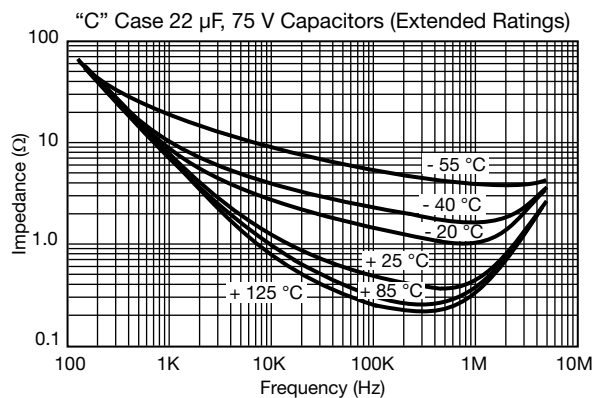
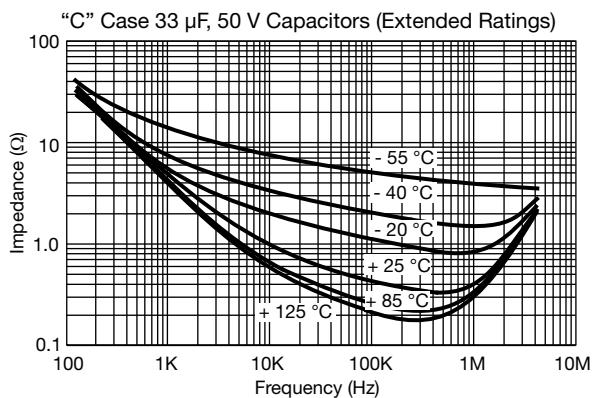



TYPICAL CURVES OF IMPEDANCE, AS A FUNCTION OF FREQUENCY

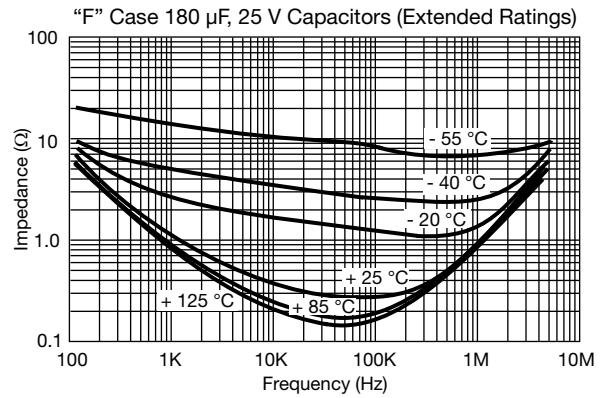
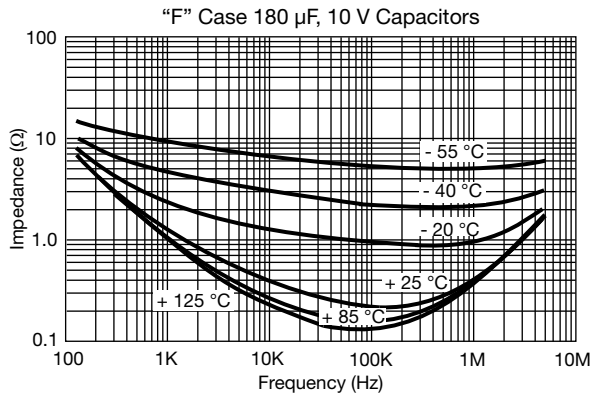



Disclaimer

ALL PRODUCT, PRODUCT SPECIFICATIONS AND DATA ARE SUBJECT TO CHANGE WITHOUT NOTICE TO IMPROVE RELIABILITY, FUNCTION OR DESIGN OR OTHERWISE.

Vishay Intertechnology, Inc., its affiliates, agents, and employees, and all persons acting on its or their behalf (collectively, "Vishay"), disclaim any and all liability for any errors, inaccuracies or incompleteness contained in any datasheet or in any other disclosure relating to any product.

Vishay makes no warranty, representation or guarantee regarding the suitability of the products for any particular purpose or the continuing production of any product. To the maximum extent permitted by applicable law, Vishay disclaims (i) any and all liability arising out of the application or use of any product, (ii) any and all liability, including without limitation special, consequential or incidental damages, and (iii) any and all implied warranties, including warranties of fitness for particular purpose, non-infringement and merchantability.

Statements regarding the suitability of products for certain types of applications are based on Vishay's knowledge of typical requirements that are often placed on Vishay products in generic applications. Such statements are not binding statements about the suitability of products for a particular application. It is the customer's responsibility to validate that a particular product with the properties described in the product specification is suitable for use in a particular application. Parameters provided in datasheets and / or specifications may vary in different applications and performance may vary over time. All operating parameters, including typical parameters, must be validated for each customer application by the customer's technical experts. Product specifications do not expand or otherwise modify Vishay's terms and conditions of purchase, including but not limited to the warranty expressed therein.

Hyperlinks included in this datasheet may direct users to third-party websites. These links are provided as a convenience and for informational purposes only. Inclusion of these hyperlinks does not constitute an endorsement or an approval by Vishay of any of the products, services or opinions of the corporation, organization or individual associated with the third-party website. Vishay disclaims any and all liability and bears no responsibility for the accuracy, legality or content of the third-party website or for that of subsequent links.

Except as expressly indicated in writing, Vishay products are not designed for use in medical, life-saving, or life-sustaining applications or for any other application in which the failure of the Vishay product could result in personal injury or death. Customers using or selling Vishay products not expressly indicated for use in such applications do so at their own risk. Please contact authorized Vishay personnel to obtain written terms and conditions regarding products designed for such applications.

No license, express or implied, by estoppel or otherwise, to any intellectual property rights is granted by this document or by any conduct of Vishay. Product names and markings noted herein may be trademarks of their respective owners.

Looking for pricing, stock, or lifecycle information?

Click below to explore more details on WIN SOURCE:

 [View 135D276X9125F6 on WIN SOURCE](#)

 [Vishay Information](#)

Optimize Your Supply Chain with WIN SOURCE Solutions

-  Global Sourcing Solution
-  Obsolete Management
-  Cost Control Management
-  Shortage Management
-  Alternative Solution
-  Excess Inventory Management