



THE DATASHEET OF HMC382LP3ETR





GaAs PHEMT MMIC LOW NOISE AMPLIFIER, 1.7 - 2.2 GHz

Typical Applications

The HMC382LP3 / HMC382LP3E is ideal for:

- Cellular/3G Infrastructure
- Base Stations & Repeaters
- CDMA, W-CDMA, & TD-SCDMA
- GSM/GPRS & EDGE

Features

- Noise Figure: 1 dB
- Output IP3: +30 dBm
- Gain: 17 dB
- Externally Adjustable Supply Current
- Single Positive Supply: +5V
- 50 Ohm Matched Input/Output

Functional Diagram

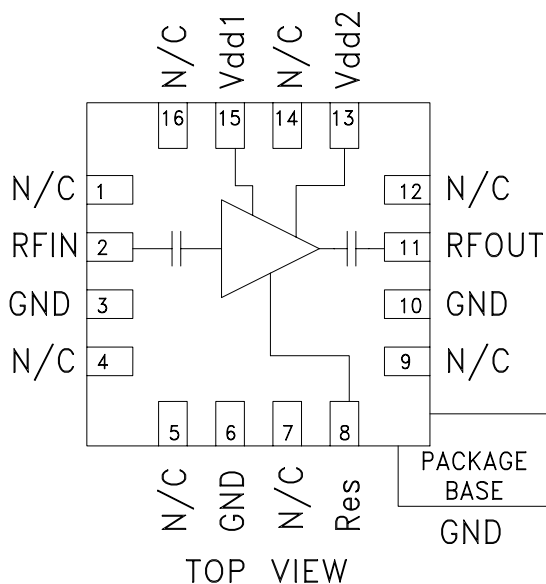

General Description

The HMC382LP3 & HMC382LP3E high dynamic range GaAs PHEMT MMIC Low Noise Amplifiers are ideal for GSM & CDMA cellular basestation front-end receivers operating between 1.7 and 2.2 GHz. This LNA has been optimized to provide 1.0 dB noise figure, 17 dB gain and +30 dBm output IP3 from a single supply of +5V. The HMC382LP3 & HMC382LP3E feature an externally adjustable supply current which allows the designer to tailor the linearity performance of the LNA for each application. For applications which require improved noise figure, please see the HMC618LP3(E).

Electrical Specifications, $T_A = +25^\circ\text{C}$, $V_{dd1}, V_{dd2} = +5\text{V}$, $R_{bias} = 16\text{ Ohms}^*$

Parameter	Min.	Typ.	Max.	Min.	Typ.	Max.	Min.	Typ.	Max.	Min.	Typ.	Max.	Units
Frequency Range	1.7 - 1.9			1.9 - 2.0			2.0 - 2.1			2.1 - 2.2			GHz
Gain	14	17		12	15		11	14		9	12		dB
Gain Variation Over Temperature		0.01	0.015		0.01	0.015		0.01	0.015		0.01	0.015	dB/°C
Noise Figure		1.0	1.3		1.05	1.35		1.15	1.45		1.2	1.5	dB
Input Return Loss		13			12			11			10		dB
Output Return Loss		10			13			12			9		dB
Reverse Isolation		37			36			35			35		dB
Output Power for 1dB Compression (P1dB)		16			16			15.5			14		dBm
Output Third Order Intercept (IP3) (-20 dBm Input Power per tone, 1 MHz tone spacing)		29.5			30			30			29.5		dBm
Supply Current (I _{dd})		67			67			67			67		mA

* R_{bias} resistor value sets current. See application circuit herein.



**GaAs PHEMT MMIC
LOW NOISE AMPLIFIER, 1.7 - 2.2 GHz**

Broadband Gain & Return Loss

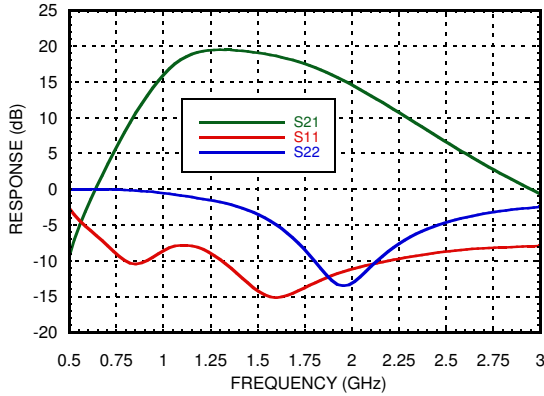

Gain vs. Temperature

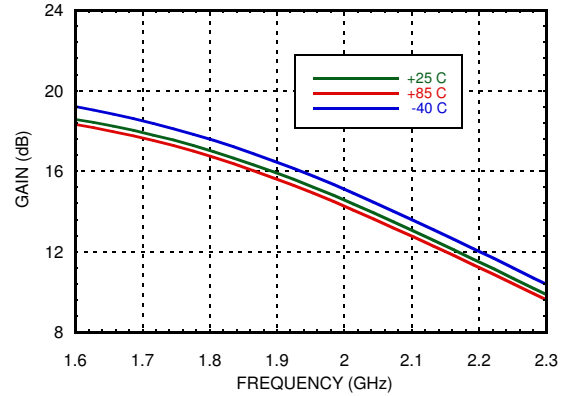

Input Return Loss vs. Temperature

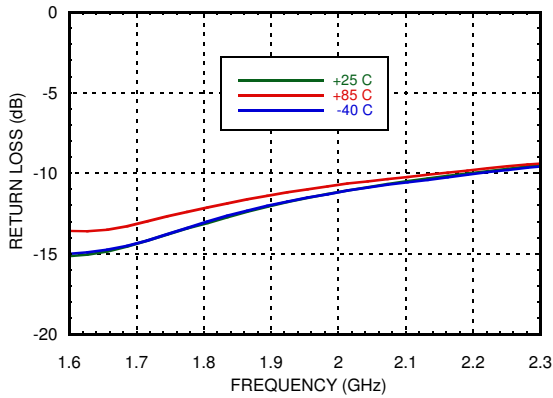

Output Return Loss vs. Temperature

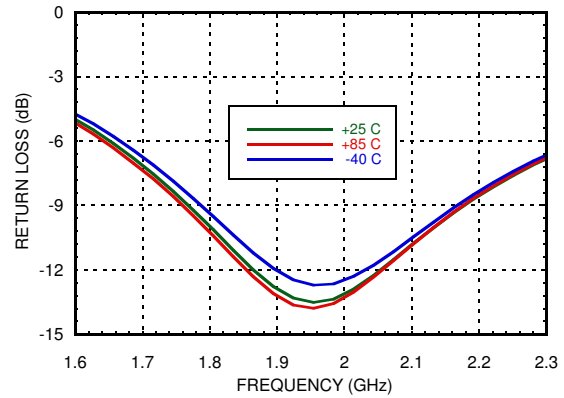

Reverse Isolation vs. Temperature

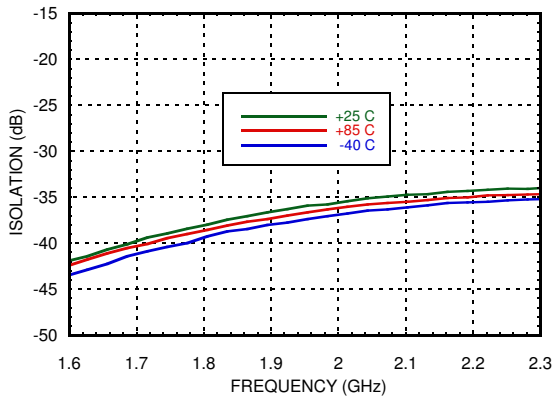

Noise Figure vs. Temperature

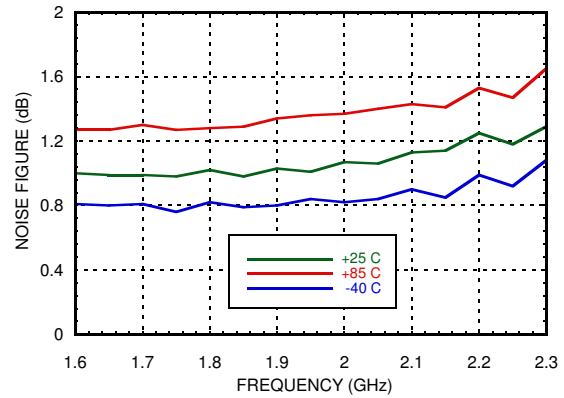



**GaAs PHEMT MMIC
LOW NOISE AMPLIFIER, 1.7 - 2.2 GHz**

P1dB vs. Temperature @ I_{dd} = 67 mA

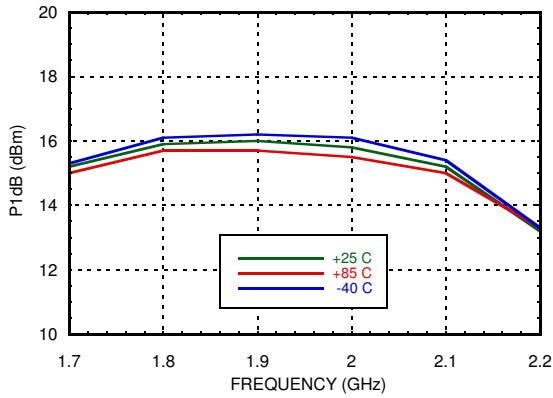

Psat vs. Temperature @ I_{dd} = 67 mA

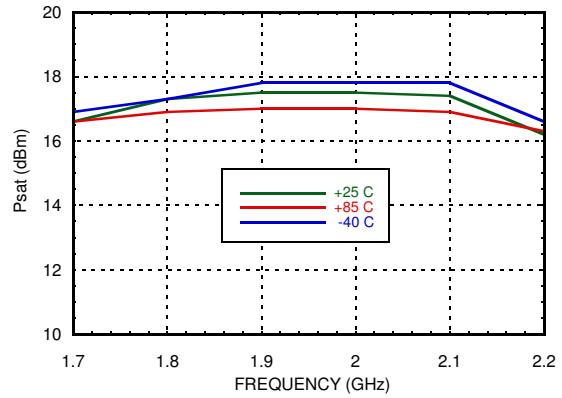

Output IP3 vs. Temperature I_{dd} = @ 67 mA

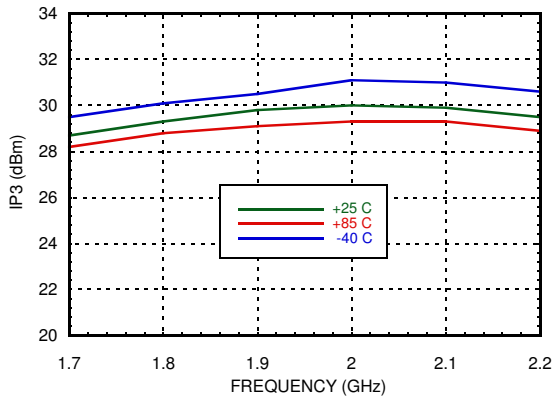

Gain, Noise Figure & P1dB vs. Supply Current @ 1900 MHz

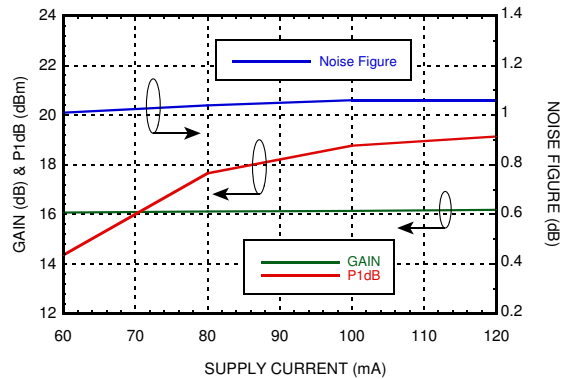



GaAs PHEMT MMIC LOW NOISE AMPLIFIER, 1.7 - 2.2 GHz

Absolute Maximum Ratings

Drain Bias Voltage (Vdd1, Vdd2)	+8.0 Vdc
RF Input Power (RFIN)(Vs = +5.0 Vdc)	+10 dBm
Channel Temperature	150 °C
Continuous P _{diss} (T = 85 °C) (derate 6.94 mW/°C above 85 °C)	0.451 W
Thermal Resistance (channel to ground paddle)	144 °C/W
Storage Temperature	-65 to +150 °C
Operating Temperature	-40 to +85 °C



**ELECTROSTATIC SENSITIVE DEVICE
OBSERVE HANDLING PRECAUTIONS**

Typical Supply Current vs. Vdd

Vdd (Vdc)	I _{dd} (mA)
+4.5	67.2
+5.0	67.2
+5.5	67.2

Recommended Bias Resistor Values for Various I_{dd1} & I_{dd2}

I _{dd1} + I _{dd2} (mA)	R _{bias} (Ohms)
60	27
70	16
80	13
100	8.2
120	3.9



**GaAs PHEMT MMIC
LOW NOISE AMPLIFIER, 1.7 - 2.2 GHz**

Outline Drawing

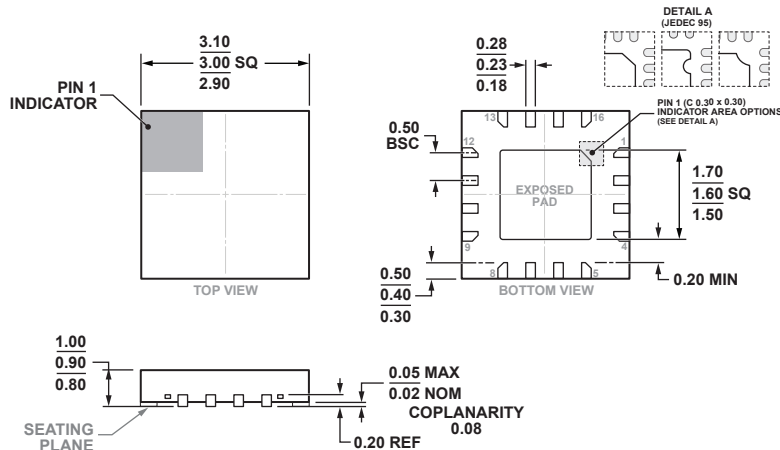

COMPLIANT WITH JEDEC STANDARDS MO-220-VEED-6.

16-Lead Lead Frame Chip Scale Package [LFCSP]
3 mm x 3 mm and 0.90 mm Package Height
(CP-16-54)
Dimensions shown in millimeters

Package Information

Part Number	Package Body Material	Lead Finish	MSL Rating ^[1]	Package Marking ^[2]
HMC382LP3E	RoHS-compliant Low Stress Injection Molded Plastic	100% matte Sn	MSL3	382 XXXX
HMC382LP3ETR	RoHS-compliant Low Stress Injection Molded Plastic	100% matte Sn	MSL3	382 XXXX

[1] Max peak reflow temperature of 260 °C
[2] 4-Digit lot number XXXX



GaAs PHEMT MMIC LOW NOISE AMPLIFIER, 1.7 - 2.2 GHz

Pin Descriptions

Pin Number	Function	Description	Interface Schematic
1, 4, 5, 7, 9, 12, 14, 16	N/C	No connection necessary. These pins may be connected to RF/DC ground. Performance will not be affected.	
2	RFIN	This pin is AC coupled and matched to 50 Ohms.	
8	Res	This pin is used to set the DC current of the amplifier by selection of external bias resistor. See application circuit.	
11	RFOUT	This pin is AC coupled and matched to 50 Ohms.	
13,15	Vdd2, Vdd1	Power supply voltage. Choke inductor and bypass capacitors are required. See application circuit.	
3, 6, 10	GND	These pins and package bottom must be connected to RF/DC ground.	

Application Circuit

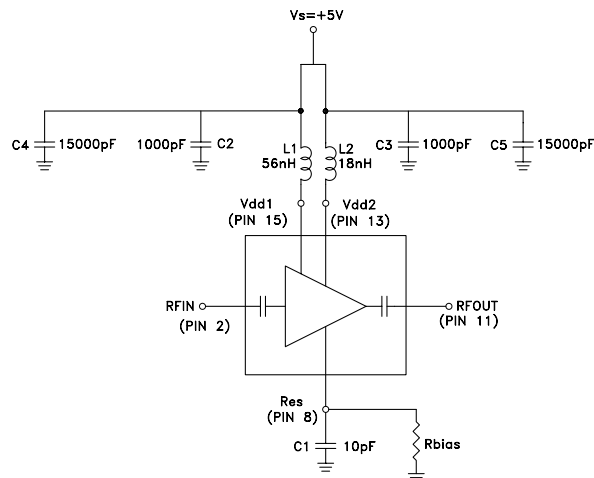

Note: L1, L2, L3 and C1 should be located as close to pins as possible.



**GaAs PHEMT MMIC
LOW NOISE AMPLIFIER, 1.7 - 2.2 GHz**

Evaluation PCB

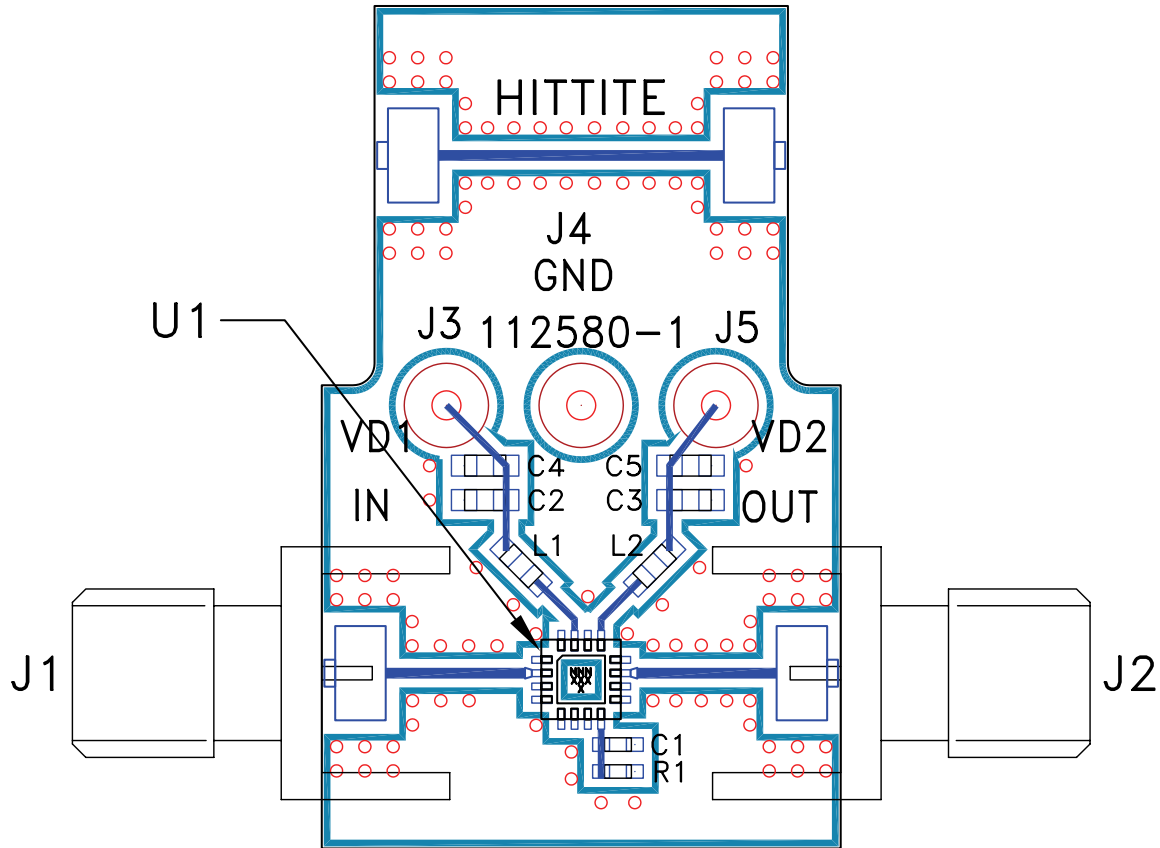

List of Materials for Evaluation PCB 112582 [1]

Item	Description
J1 - J2	PCB Mount SMA RF Connector
J3 - J5	DC Pin
C1	10 pF Capacitor, 0402 Pkg.
C2, C3	1000 pF Capacitor, 0603 Pkg.
C4, C5	15000 pF Capacitor, 0603 Pkg
L1	56nH Inductor, 0603 Pkg.
L2	18nH Inductor, 0603 Pkg.
R1	Resistor, 0402 Pkg..
U1	HMC382LP3 / HMC382LP3E Amplifier
PCB [2]	112580 Evaluation PCB

The circuit board used in the application should use RF circuit design techniques. Signal lines should have 50 Ohm impedance while the package ground leads and exposed paddle should be connected directly to the ground plane similar to that shown. A sufficient number of via holes should be used to connect the top and bottom ground planes. The evaluation circuit board shown is available from Analog Devices upon request.

[1] Reference this number when ordering complete evaluation PCB

[2] Circuit Board Material: Rogers 4350



HMC382LP3 / 382LP3E

v02.0320

GaAs PHEMT MMIC LOW NOISE AMPLIFIER, 1.7 - 2.2 GHz

Notes

Looking for pricing, stock, or lifecycle information?

Click below to explore more details on WIN SOURCE:

- ⊖ [View HMC382LP3ETR on WIN SOURCE](#)
- ⊖ [Analog Devices Inc. Information](#)

Optimize Your Supply Chain with WIN SOURCE Solutions

- ✓ Global Sourcing Solution
- ✓ Obsolete Management
- ✓ Cost Control Management
- ✓ Shortage Management
- ✓ Alternative Solution
- ✓ Excess Inventory Management