



**THE DATASHEET OF  
PLT10HH101150PNL**



# Reference Only

**SMD type common-mode choke coil**  
**PLT10HH□□□□□PN□** Murata Standard Reference Specification **[AEC-Q200]**

### 1. Scope

This reference specification applies to SMD type common-mode choke coil PLT10H Series for Automotive Electronics based on AEC-Q200.

### 2. Part Numbering

(Ex.) PLT 10H H 102 6R0 P N L  
 Product ID Type Application Common Mode Rated Winding Dimension Packaging  
 Impedance Zc Current Mode code  
 H : Automotive L : Taping (Φ178mm reel)  
K : Taping (Φ330mm reel)  
B : Bulk

### 3. Rating

Customer Part Number	MURATA Part Number	Common Mode Impedance Zc (at10MHz) (Ω) Typ.	Rated Voltage V(DC)	Withstand Voltage V(DC)	* Rated Current (A)	DC Resistance (Rdc) (mΩ)	Insulation Resistance (I.R.) (MΩ min.)	Inductance (L) (μH min.)	ESD Rank 6: ≥25kV (AD)
	PLT10HH1026R0PNL	1000	100	250	6	8.0±0.5	10	20	6
	PLT10HH1026R0PNK								
	PLT10HH1026R0PNB								
	PLT10HH9016R0PNL	900	100	250	6	8.0±0.5	10	14	
	PLT10HH9016R0PNK								
	PLT10HH9016R0PNB								
	PLT10HH501100PNL	500	100	250	10	3.6±0.5	10	9	
	PLT10HH501100PNK								
	PLT10HH501100PNB								
	PLT10HH401100PNL	400	100	250	10	3.6±0.5	10	6	
	PLT10HH401100PNK								
	PLT10HH401100PNB								
	PLT10HH101150PNL	100	300	750	15	1.8±0.5	10	2	
	PLT10HH101150PNK								
	PLT10HH101150PNB								
	PLT10HH450180PNL	45	300	750	18	1.3±0.5	10	0.8	
	PLT10HH450180PNK								
	PLT10HH450180PNB								

- Operating Temperature range (Product temperature; Self-temperature rise is included)
  - : -55°C~+125°C (PLT10HH9016R0 / PLT10HH401100/ PLT10HH101150/ PLT10HH450180)
  - : -55°C~+105°C (PLT10HH1026R0 / PLT10HH501100)
- Storage Temperature range : -55°C~+125°C

■\* Rated Current is derated as below figure depending on the operating temperature.

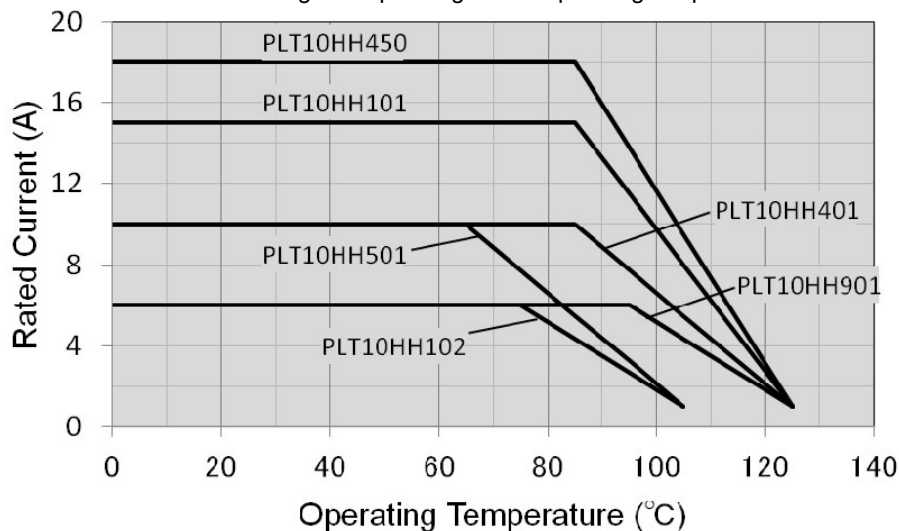

### Standard Testing Conditions

< Unless otherwise specified >

Temperature: Ordinary Temp. 15 °C to 35 °C

Humidity: Ordinary Humidity 25 %(RH) to 85 %(RH)

< In case of doubt >

Temperature: 20 °C ± 2 °C

Humidity: 60 %(RH) to 70 %(RH)

Atmospheric pressure: 86 kPa to 106 kPa

### 4. Dimension

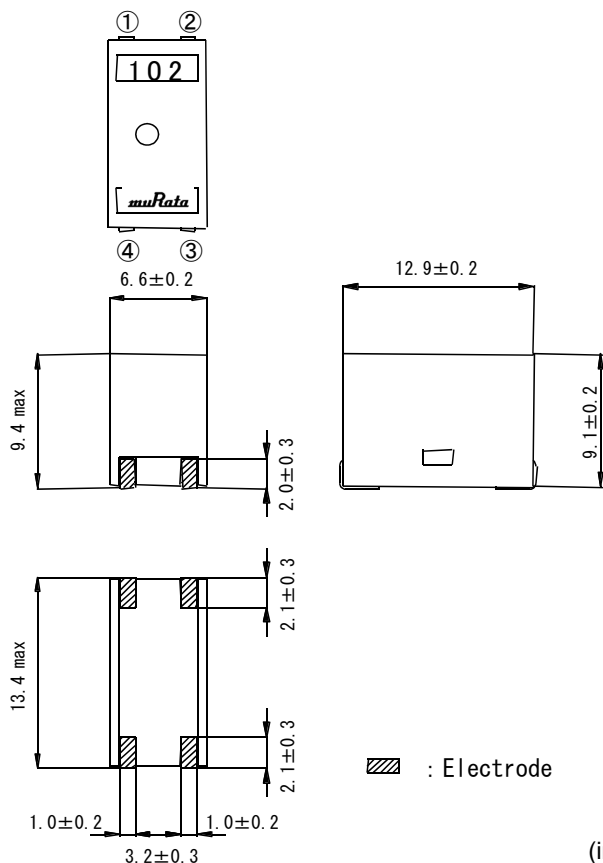

### Equivalent Circuit

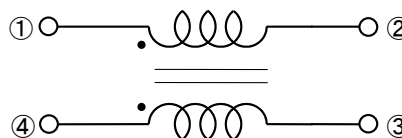

No polarity

### Unit Mass (Typical value)

2.1g

: Electrode

(in mm)

### 5. Marking

(1) Manufacturer Identification : (*muRata*)

(2) Parts Number : Common Mode Impedance Zc

PLT10HH1026R0PN□ : ( 102 )

PLT10HH9016R0PN□ : ( 901 )

PLT10HH501100PN□ : ( 501 )

PLT10HH401100PN□ : ( 401 )

PLT10HH101150PN□ : ( 101 )

PLT10HH450180PN□ : ( 450 )

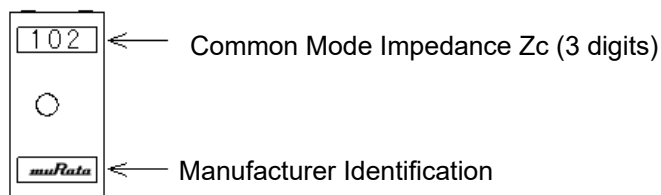

# Reference Only

## 6. Electrical Performance

No.	Item	Specification	Test method
6.1	Common Mode Impedance (Zc) Typ.	Meet item 3	Measuring Frequency: 10MHz (ref.item 8) Measuring Equipment: KEYSIGHT 4294A or the equivalent Use a cable / connector of 50Ω impedance.
6.2	Withstand Voltage	Products shall not be damaged.	Voltage: Rated Voltage×250% (ref.item 8) Time:1~5s Measuring current: 10mA max.
6.3	Insulation Resistance (I.R.)	Meet item 3	Voltage: Rated Voltage (ref.item 8) Time: 30s max. Measuring current: 10mA max Measuring Equipment: KEYSIGHT 4339A or the equivalent
6.4	DC Resistance (Rdc)	Meet item 3	Measuring method: four-terminal method (ref.item 8)
6.5	Inductance (L)	Meet item 3	Measuring Frequency:1±0.1kHz (ref.item 8) Voltage: 1V (rms) max. Measuring Equipment: KEYSIGHT 4284A or the equivalent

## 7. Q200 Requirement

### 7-1. Performance (based on Table 13 for Ferrite EMI SUPPRESSORS/FILTERS)

AEC-Q200 Rev.D issued June 1, 2010

AEC-Q200			Murata Specification / Deviation								
No.	Stress	Test Method									
3	High Temperature Exposure	1000hours at Maximum Operating Temperature Set for 24hours at room temperature, then measured.	Meet Table A after testing. Table A <table border="1" style="margin-left: 20px;"> <tr> <td>Appearance</td> <td>No damage</td> </tr> <tr> <td>Inductance change (%ΔL)</td> <td>within ±15%</td> </tr> <tr> <td>Insulation Resistance (I.R.)</td> <td>Meet item 3</td> </tr> <tr> <td>Withstand Voltage</td> <td>Products shall not be damaged.</td> </tr> </table>	Appearance	No damage	Inductance change (%ΔL)	within ±15%	Insulation Resistance (I.R.)	Meet item 3	Withstand Voltage	Products shall not be damaged.
Appearance	No damage										
Inductance change (%ΔL)	within ±15%										
Insulation Resistance (I.R.)	Meet item 3										
Withstand Voltage	Products shall not be damaged.										
4	Temperature Cycling	1000cycles -55 deg C to + Maximum Operating Temperature Set for 24hours at room temperature, then measured.	Meet Table A after testing.								
5	Destructive Physical Analysis	Per EIA469 No electrical tests	Not Applicable								
7	Biased Humidity	1000hours at 85 deg C, 85%RH Apply max rated voltage.	Meet Table A after testing. (ref.item 8.2)								
8	Operational Life	Apply Maximum Operating Temperature 1000hours Set for 24hours at room temperature, then measured.	Meet Table A after testing. Apply rated voltage. (ref.item 8.2)								
9	External Visual	Visual inspection	No abnormalities								
10	Physical Dimension	Meet ITEM 4 (Style and Dimensions)	No defects								
12	Resistance to Solvents	Per MIL-STD-202 Method 215	Not Applicable								
13	Mechanical Shock	Per MIL-STD-202 Method 213 Condition F: 1500g's(14.7N)/0.5ms/ Half sine	Meet Table A after testing.								

AEC-Q200			Murata Specification / Deviation
No	Stress	Test Method	
14	Vibration	5g's(0.049N) for 20 minutes, 12cycles each of 3 orientations Test from 10-2000Hz. 12cycles each of 3 orientations	Meet Table A after testing.
15	Resistance to Soldering Heat	No-heating Solder temperature 260C+/-5 deg C Immersion time 10s	Pre-heating : 150 to 180C / 90±30s Meet Table A after testing.
17	ESD	Per AEC-Q200-002	Meet Table A after testing. ESD Rank: Refer to Item 3. Rating.
18	Solderbility	Per J-STD-002	Method b : Not Applicable 95% of the terminations is to be soldered.(except partly-exposed wire) Flux:Ethanol solution of rosin,25(wt)% includes activator equivalent to 0.06 to 0.10(wt)% chlorine
19	Electrical Characterization	Measured : Inductance	Refer to 3.Rating.
20	Flammability	Per UL-94	Not Applicable
21	Board Flex	Epoxy-PCB(1.6mm) Deflection 2mm(min) 60 sec minimum holding time	Meet Table A after testing.
22	Terminal Strength	Per AEC-Q200-006 A force of 17.7N for 60sec	No defects
30	Electrical Transient Conduction	Per ISO-7637-2	Not Applicable

### 8. Measuring Terminal

(When measuring and supplying the voltage, the following terminal is applied.)

No.	Item	Measuring terminal
8.1	Inductance (L) DC Resistance (Rdc)	
8.2	Withstand voltage Insulation Resistance (I.R.) Biased Humidity Operational Life	
8.3	Common Mode Impedance(Zc)	

### 9. Measuring method for common mode impedance.

Measured common mode impedance may be included measurement error due to stray capacitance, residual inductance of test fixture.

To correct this error, the common mode impedance should be calculate as follows;

- (1) Measure admittance of the fixture(opened),  $G_o$   $B_o$ .
- (2) Measure impedance of the fixture(shorted),  $R_s$   $X_s$ .
- (3) Measure admittance of the specimen,  $G_m$   $B_m$ .
- (4) Calculate corrected impedance  $|Z|$  using the formula below.

$$|Z| = (R_x^2 + X_x^2)^{1/2}$$

Where

$$R_x = \frac{G_m - G_o}{(G_m - G_o)^2 + (B_m - B_o)^2} - R_s$$

$$X_x = \frac{-(B_m - B_o)}{(G_m - G_o)^2 + (B_m - B_o)^2} - X_s$$

### 10. P.C.B., Flux, Solder and Soldering condition

Test shall be done using P.C.B., Flux, Solder and Soldering condition which are specified in item 13 except the case of being specified special condition.

### 11. Specification of Packaging

#### 11.1 Appearance and Dimensions (24mm-wide, Plastic tape)

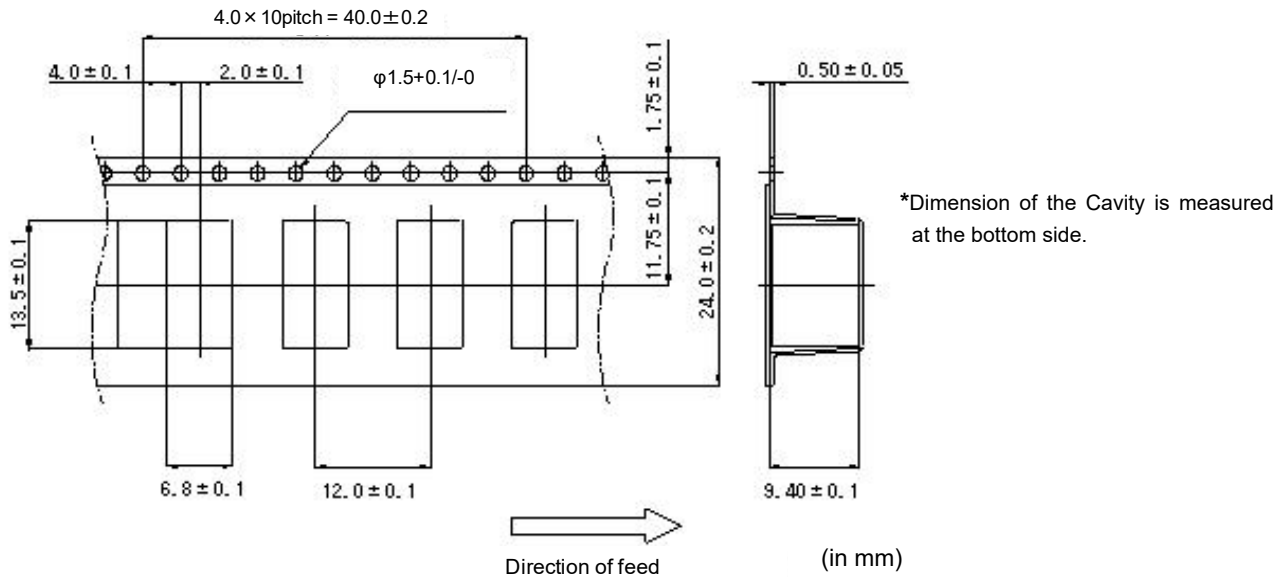

\*Dimension of the Cavity is measured at the bottom side.

< Product direction >

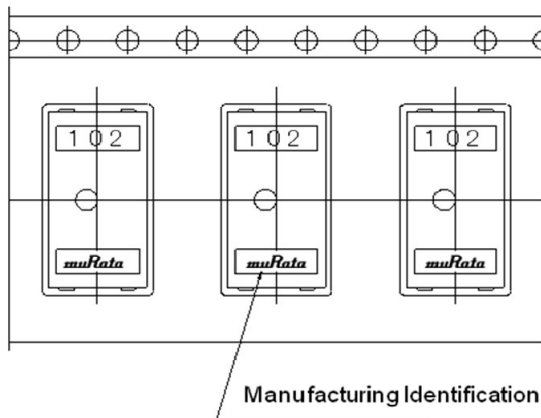

#### 11.2 Specification of Taping

- (1) Packing quantity (Standard quantity)
  - Φ178 mm reel: 125 pcs. / reel
  - Φ330 mm reel: 500 pcs. / reel
- (2) Packing Method
 

Products shall be packaged in each embossed cavity of plastic tape and sealed with cover tape.
- (3) Spliced point
 

The cover tape has no spliced point.
- (4) Sprocket Hole
 

The sprocket holes are to the right as the tape is pulled toward the user.
- (5) Missing components number
 

Missing components number within 0.025% of the number per reel or 1 pc., whichever is greater, and are not continuous. The specified quantity per reel is kept.

#### 11.3 Pull Strength of Cover Tape

10N minimum

#### 11.4 Peeling off force of Cover Tape

0.2N to 0.7N (minimum value is typical.)

Speed of Peeling off: 300 mm / min

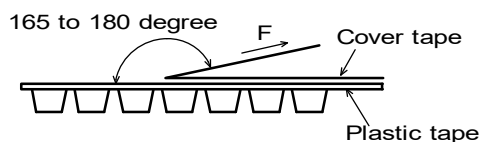

### 11.5 Dimensions of Leader-tape, Trailer and Reel

There shall be leader-tape (cover tape only and empty tape) and trailer-tape (empty tape) as follows.

【Packaging code : L (Φ178mm reel)】

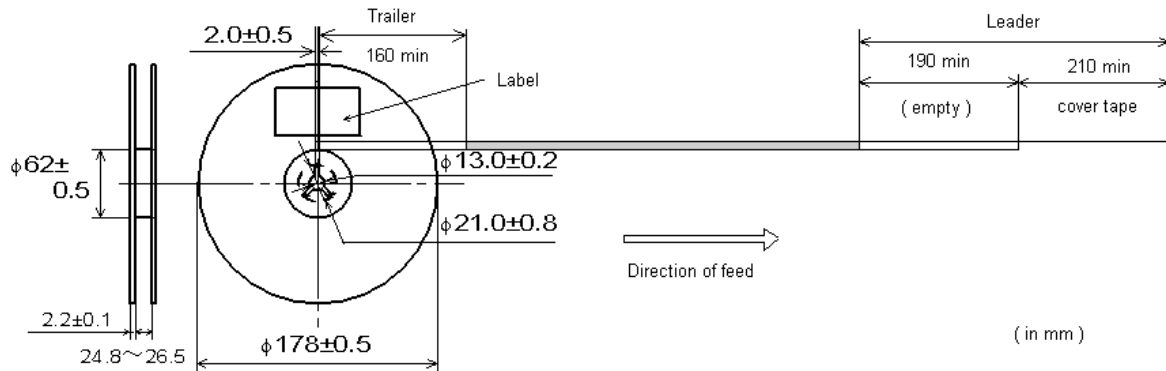

【Packaging code : K (Φ330mm reel)】

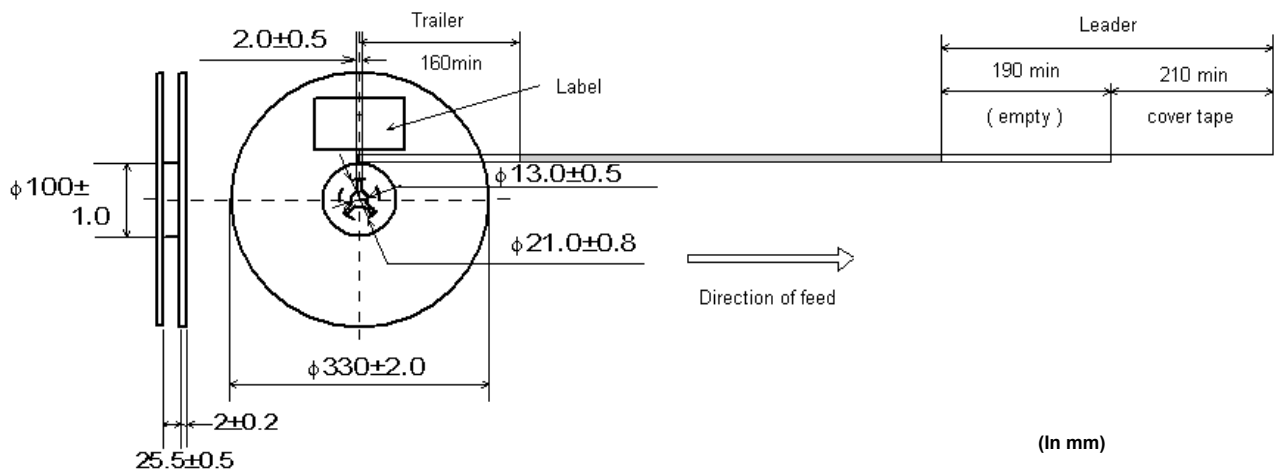

### 11.6 Marking for reel

Customer part number, MURATA part number, Inspection number(\*1), RoHS Marking(\*2), Quantity, etc

\*1) < Expression of Inspection No. > □□ ○○○○ ◇◇◇◇

- ① Factory code
- ② Date      First digit : year / Last digit of year  
                Second digit : Month / Jan. → 1 to 9, Oct. to Dec. → O, N, D  
                Third, Fourth digit : Day
- ③ Serial No.

\*2) < Expression of RoHS Marking >      ROHS - Y (△)

- ① RoHS regulation conformity parts
- ② MURATA classification number

### 11.7 Marking for Outside package

Customer name, Purchasing Order Number, Customer Part Number, MURATA part number, RoHS Marking (\*2), Quantity, etc

### 11.8 Specification of Outer Case

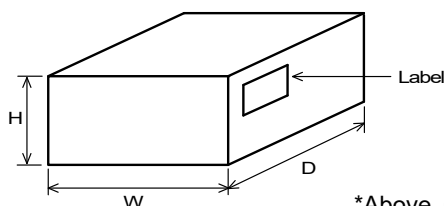

Reel	Outer case Dimensions (mm)			Standard Reel Quantity in Outer case (Reel)
	W	D	H	
Φ178mm	186	186	93	3
Φ330mm	340	340	85	2

\*Above Outer Case size is typical. It depends on a quantity of an order.

## 12. ⚠ Caution

### 12.1 Mounting Direction

Mount products in right direction.

Wrong direction which is 90° rotated from right direction causes not only open or short circuit but also flames or other serious trouble.

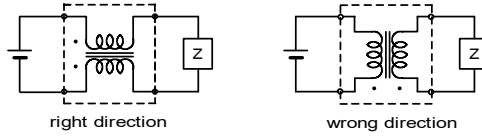

### 12.2 Fail Safe

Be sure to provide an appropriate fail-safe function on your product to prevent from a second damage that may be caused by the abnormal function or the failure of our products.

### 12.3 Limitation of Applications

Please contact us before using our products for the applications listed below which require especially high reliability for the prevention of defects which might directly cause damage to the third party's life, body or property.

- |                                   |  |
|-----------------------------------|--|
| (1) Aircraft equipment            | (6) Transportation equipment (trains, ships, etc.)   |
| (2) Aerospace equipment           | (7) Traffic signal equipment   |
| (3) Undersea equipment            | (8) Disaster prevention / crime prevention equipment   |
| (4) Power plant control equipment | (9) Data-processing equipment  |
| (5) Medical equipment             | (10) Applications of similar complexity and /or reliability requirements to the applications listed in the above |

### 12.4 Attention regarding product's heat generation

Please pay special attention to the product's heat generation such as beyond Operating Temperature range, mounting product in close proximity to other products that radiate heat and beyond the rated current.

### 12.5 Corrosive gas

Please refrain from use since contact with environments with corrosive gases (sulfur gas [hydrogen sulfide, sulfur dioxide, etc.], chlorine, ammonia, etc.) or oils (cutting oil, silicone oil, etc.) that have come into contact with the previously stated corrosive gas environment will result in deterioration of product quality or an open from deterioration due to corrosion of product electrode, etc. We will not bear any responsibility for use under these environments.

## 13. Notice

Products can only be soldered with reflow.

This product is designed for solder mounting.

Please consult us in advance for applying other mounting method such as conductive adhesive.

### 13.1 Flux and Solder

Flux	Use rosin-based flux. Do not use highly acidic flux (with chlorine content exceeding 0.2(wt%)) Do not use water soluble flux.
Solder	Use Sn-3.0Ag-0.5Cu solder

Other flux (except above) please contact us for details, then use.

### 13.2 Notes for Assembling

<Exclusive Use of Reflow Soldering>

When installing by the flow soldering, the degradation of the insulation resistance sometimes occurs.

Products can only be soldered with reflow.

The use in flow soldering is reserved.

< Thermal Shock >

Pre-heating should be in such a way that the temperature difference between solder and products surface is limited to 150 °C max. Also cooling into solvent after soldering should be in such a way that the temperature difference is limited to 150 °C max.

Insufficient pre-heating may cause cracks on the ferrite, resulting in the deterioration of product quality.

### 13.3 Attention Regarding P.C.B. Bending

The following shall be considered when designing P.C.B.'s and laying out products.

- (1) P.C.B. shall be designed so that products are not subject to the mechanical stress for board warpage.

[ Products Direction ]

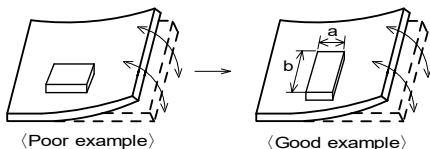

Products shall be located in the sideways direction (Length: a < b) to the mechanical stress.

(2) Components location on P.C.B. separation.

It is effective to implement the following measures, to reduce stress in separating the board.  
 It is best to implement all of the following three measures; however, implement as many measures as possible to reduce stress.

Contents of Measures	Stress Level
(1) Turn the mounting direction of the component parallel to the board separation surface.	$A > D *1$
(2) Add slits in the board separation part.	$A > B$
(3) Keep the mounting position of the component away from the board separation surface.	$A > C$

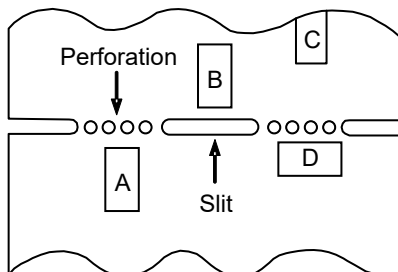

\*1  $A > D$  is valid when stress is added vertically to the perforation as with Hand Separation.  
 If a Cutting Disc is used, stress will be diagonal to the PCB, therefore  $A > D$  is invalid.

(3) Mounting Components Near Screw Holes

When a component is mounted near a screw hole, it may be affected by the board deflection that occurs during the tightening of the screw. Mount the component in a position as far away from the screw holes as possible.

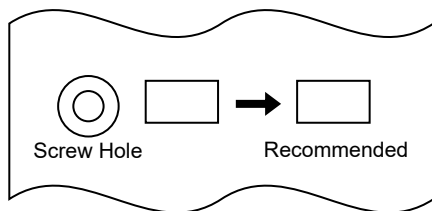

**13.4 Attention Regarding P.C.B. Design**

< The Arrangement of Products >

P.C.B. shall be designed so that products are far from the portion of perforation.

The portion of perforation shall be designed as narrow as possible, and shall be designed so as not to be applied the stress in the case of P.C.B. separation.

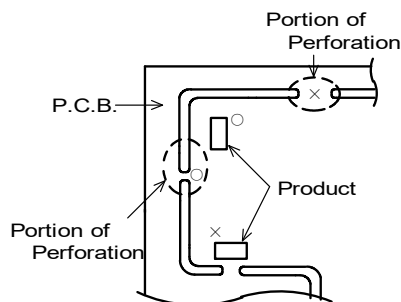

Products shall not be arranged on the line of a series of holes when there are big holes in P.C.B. (Because the stress concentrates on the line of holes.)

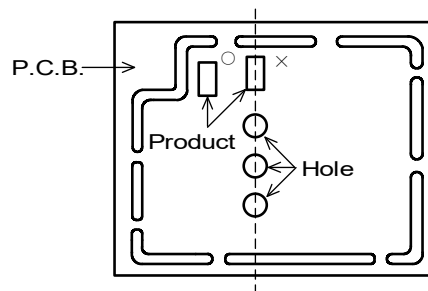

< Products Placing >

Support pins shall be set under P.C.B. to prevent causing a warp to P.C.B. during placing the products on the other side of P.C.B.

< P.C.B. Separation >

P.C.B. shall not be separated with hand.  
 P.C.B. shall be separated with the fixture so as not to cause P.C.B. bending.

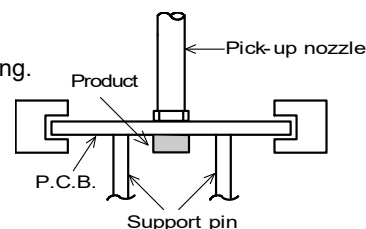

### 13.5 Standard Land Dimensions

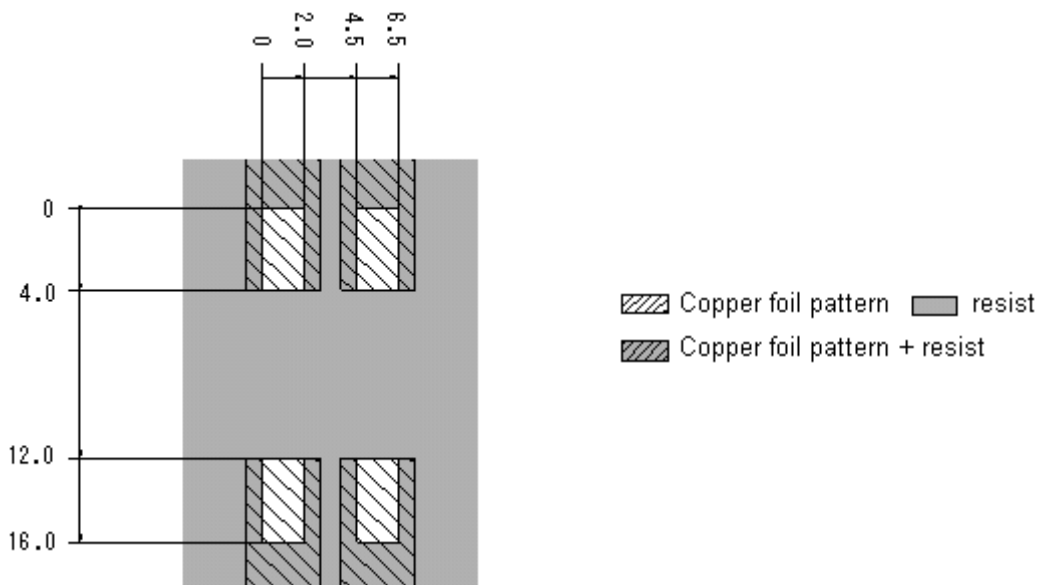

- (1) Design the land pads for this part as shown above on both side printed circuit boards (or a multiple layered substrate ).
- (2) To use PLT10HH with high current such as its rated current 6A~18A, the pattern is also should be applicable for such high current.  
The thickness of copper foil for PLT10HH should be designed as temperature rise is lower than 40 degree C (DC resistance of land and pattern should be low according to the current).

### 13.6 Reflow Soldering

Standard soldering profile and the limit soldering profile is as follows.

The excessive soldering conditions may cause leaching of the electrode and/or resulting in the deterioration of product quality.

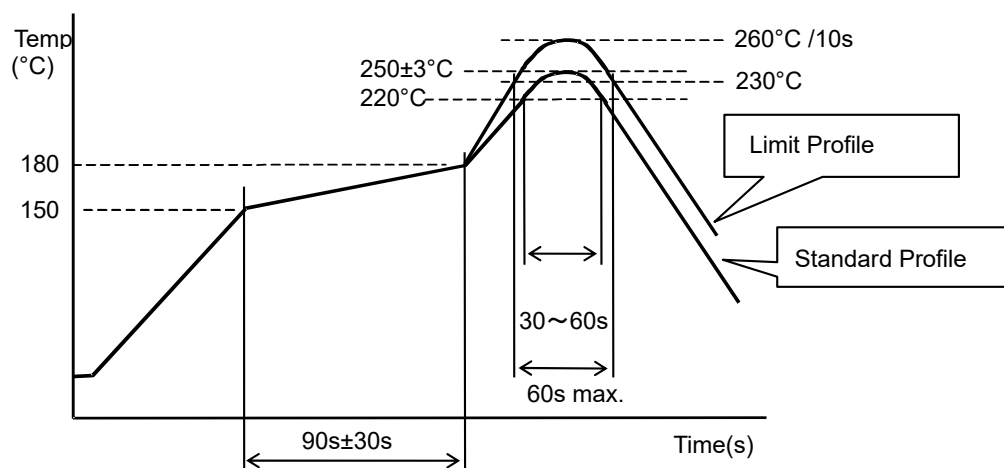

	Standard Profile	Limit Profile
Pre-heating	150°C ~ 180°C , 90s ± 30s	
Heating	above 220°C , 30s ~ 60s	above 230°C , 60s max.
Peak temperature	250°C ± 3°C	260°C , 10s
Cycle of reflow	2 times	2 times

- (1) Solder paste printing for reflow soldering
  - Standard thickness of solder paste should be 150 to 200 μm.
  - Incidentally, depending on the reflow condition and the way of heat conduction, the solder would not wet up the terminal, being possible to lead to not enough connection between terminals and lands on the circuit board / open circuit in the circuit board. In case of use, always evaluate this part in your products with actual use condition.
  - For the solder paste printing pattern, use standard land dimensions.
  - For the resist and copper foil pattern, use standard land dimensions.
  - Use Sn-3.0Ag-0.5Cu solder

(2) Reworking with Soldering iron

· The following conditions shall be strictly followed when using a soldering iron.

Pre-heating: 150°C, 1 min

Soldering iron: 80W max.

Tip temperature/ Soldering time: 400°C ± 5°C, within 5s

Times : 2times max.

Note: Do not touch the products directly with the tip of the soldering iron.

### 13.7 Cleaning Conditions

Do not clean after soldering.

### 13.8 Handling of a substrate

After mounting products on a substrate, do not apply any stress to the product caused by bending or twisting to the substrate when cropping the substrate, inserting and removing a connector from the substrate or tightening screw to the substrate.

Excessive mechanical stress may cause cracking in the product.

Bending

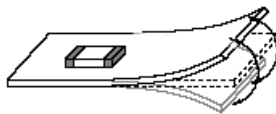

Twisting

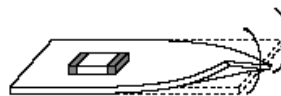

### 13.9 Operating Environment

Do not use this product under the following environmental conditions, on deterioration of the Insulation Resistance and/or corrosion of Inner Electrode may result from the use.

- (1) In the corrodible atmosphere (acidic gas, alkaline gas, chlorine, sulfur gas, organic gas and etc.)
- (2) In the atmosphere where liquid such as organic solvent, may splash on the products.
- (3) In the atmosphere where the temperature / humidity changes rapidly and it is easy to dew.
- (4) In the atmosphere where the product is covered with dust or is subjected to salty breeze.

### 13.10 Storage Conditions

(1)Storage period

Use the products within 12 months after delivered.

Solderability should be checked if this period is exceeded.

(2)Storage conditions

• Products should be stored in the warehouse on the following conditions.

Temperature: -10°C to 40°C

Humidity: 15% to 85% relative humidity

No rapid change on temperature and humidity

- Don't keep products in corrosive gases such as sulfur, chlorine gas or acid, or it may cause oxidization of electrode, resulting in poor solderability.
- Products should be stored on the palette for the prevention of the influence from humidity, dust and so on.
- Products should be stored in the warehouse without heat shock, vibration, direct sunlight and so on.
- Avoid storing the product by itself bare (i.e.exposed directly to air).

(3)Delivery



Care should be taken when transporting or handling product to avoid excessive vibration or mechanical shock.

## 14. **△Note**

- (1)Please make sure that your product has been evaluated in view of your specifications with our product being mounted to your product.
- (2)You are requested not to use our product deviating from the reference specifications.
- (3)The contents of this reference specification are subject to change without advance notice. Please approve our product specifications or transact the approval sheet for product specifications before ordering.

## Looking for pricing, stock, or lifecycle information?

Click below to explore more details on WIN SOURCE:

-  [View PLT10HH101150PNL on WIN SOURCE](#)
-  [Murata Electronics North America Information](#)

## Optimize Your Supply Chain with WIN SOURCE Solutions

-  Global Sourcing Solution
-  Obsolete Management
-  Cost Control Management
-  Shortage Management
-  Alternative Solution
-  Excess Inventory Management