



THE DATASHEET OF
MT-6-12



MT / DMT Series

Two-4-One™ Triple Output Transformers

For 5 VDC and ± 12 VDC or ± 15 VDC Regulated Power Supplies

Signal's MT and DMT transformers have all of the performance features of our 241 series.

General Specifications

- Power - 30 VA, 56 VA and 100 VA
- Dielectric Strength - 2500 Vrms Hipot
- Primaries - Single or dual primaries 115 V or 115/230 V nominal, 50/60 Hz. Input range 100 V to 130 V or 200 V to 260 V
- Secondaries - Dual complementary outputs (5 VDC with ± 12 VDC or 5 VDC with ± 15 VDC)
- Terminals - Solder lug / quick connect type terminals
- Insulation - Class B (130° C) UL E66312
- RoHS compliant

Agency Certifications

- UL 1446 UL File # E66312
- UL recognized to UL 506 / UL5085-2, File # E63829
- CSA certified to C22.2 #66.1, File # 221070

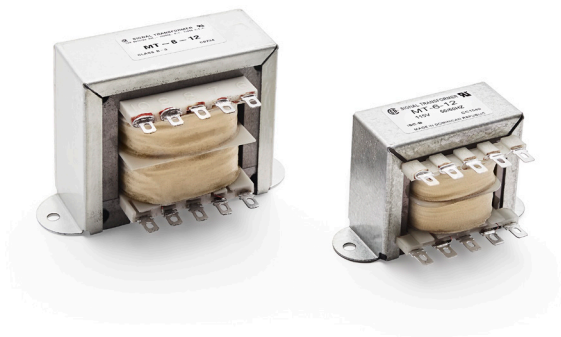

Part Number Selection

Part Number - Primary 50/60 Hz		DC Output	
115 V	115/230 V	Regulator I	Regulator II
MT-6-12	DMT-6-12	5 V @ 1.75 A	±12 V @ 210 mA
MT-6-15	DMT-6-15	5 V @ 1.75 A	±15 V @ 175 mA
MT-7-12	DMT-7-12	5 V @ 2.8 A	±12 V @ 350 mA
MT-7-15	DMT-7-15	5 V @ 2.8 A	±15 V @ 280 mA
MT-8-12	DMT-8-12	5 V @ 4 A	±12 V @ 600 mA
MT-8-15	DMT-8-15	5 V @ 4 A	±15 V @ 500 mA

Mechanical Specifications

Size	Dimensions						Weight
	L	W	H	A	B	ML (typ)	lbs (kg)
	Inches (mm)						
6	3.25 (82.6)	1.74 (44.3)	1.96 (49.8)	2.35 (59.7)	1.14 (28.9)	2.81 (71.4)	1.1 (0.50)
7	3.68 (93.5)	1.94 (49.2)	2.28 (57.8)	2.70 (68.4)	1.14 (28.9)	3.12 (79.4)	1.7 (0.77)
8	4.03 (102.4)	2.30 (58.5)	2.58 (65.5)	3.08 (78.2)	1.43 (36.2)	3.56 (90.4)	2.75 (1.25)

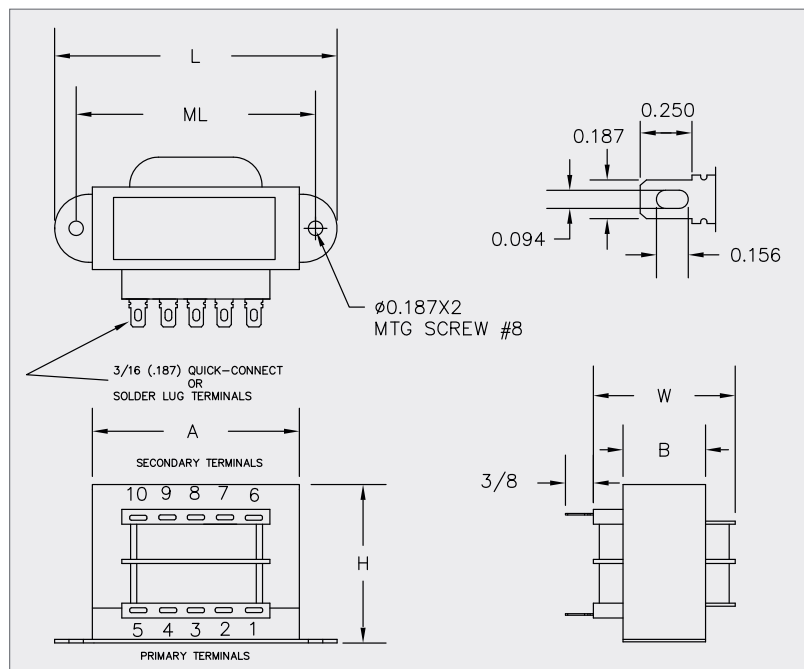

Custom versions available upon request.



128 Atlantic Avenue, Lynbrook, NY 11563
 Toll Free 866-239-5777 | Tel 516-239-5777 | Fax 516-239-7208
 sales@signaltransformer.com | techhelp@signaltransformer.com

belfuse.com/signal

Suggested Components

Part Number Primary 50/60 Hz		Size	Suggested Components (C ₂ and C ₄ See Note 1)						
115 V	115/230 V		C ₁	C ₃	IC1 ³	IC2 ³	IC3 ³	D1 ⁴	D2 ⁴
MT-6-12	DMT-6-12	6	10 KMFD @ 20 VDC	1.5 KMFD @ 50 VDC	LM-323K-5	LM-340K-12	LM-320K-12	3N253	3N247
MT-6-15	DMT-6-15	6			LM-323K-5	LM-340K-15	LM-320K-15	3N253	3N247
MT-7-12	DMT-7-12	7	15 KMFD @ 20 VDC	2 KMFD @ 50 VDC	LM-323K-5	LM-340K-12	LM-320K-12	MDA-400	3N247
MT-7-15	DMT-7-15	7			LM-323K-5	LM-340K-15	LM-320K-15	MDA-400	3N247
MT-8-12	DMT-8-12	8	26 KMFD @ 20 VDC	3.1 KMFD @ 50 VDC	LM-338 ²	LM-340K-12	LM-320K-12	MDA-800	3N247
MT-8-15	DMT-8-15	8			LM-338 ²	LM-340K-15	LM-320K-15	MDA-800	3N247

Note 1: Output capacitors C₂ and C₄ are required to stabilize regulators. Values can be 1 MFD min. tantalum or 10 MFD min. electrolytic, 20 V min.
 Note 2: LM-338 is an adjustable regulator and Mfr's specifications (National Semiconductor) should be consulted for values of external components.
 Note 3: All IC's are National Semiconductor types.
 Note 4: All diodes are Motorola types.

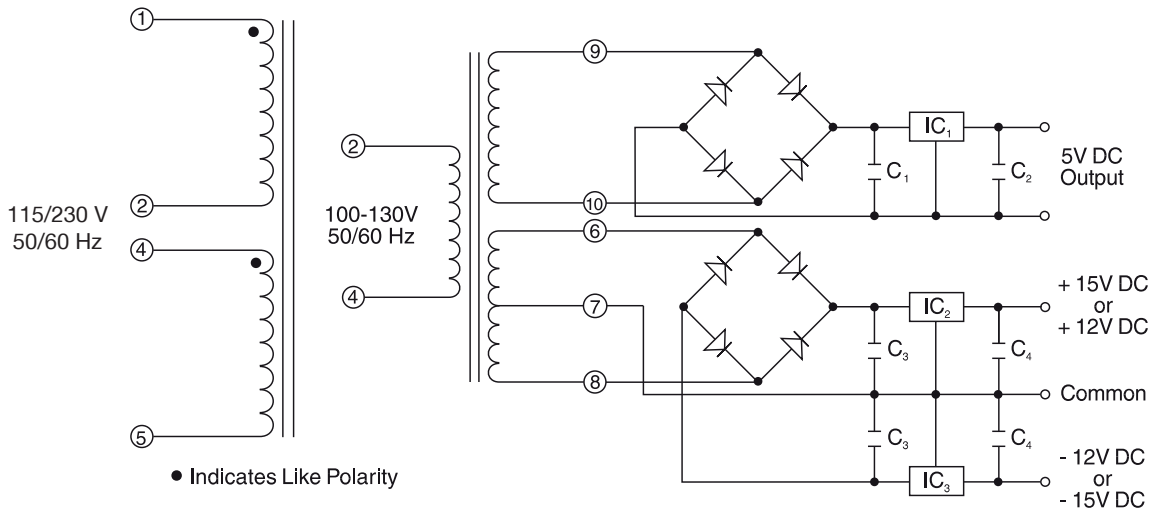

Custom versions available upon request.





128 Atlantic Avenue, Lynbrook, NY 11563
 Toll Free 866-239-5777 | Tel 516-239-5777 | Fax 516-239-7208
 sales@signaltransformer.com | techhelp@signaltransformer.com

belfuse.com/signal

Looking for pricing, stock, or lifecycle information?

Click below to explore more details on WIN SOURCE:

-  [View MT-6-12 on WIN SOURCE](#)
-  [Signal Transformer Information](#)

Optimize Your Supply Chain with WIN SOURCE Solutions

-  Global Sourcing Solution
-  Obsolete Management
-  Cost Control Management
-  Shortage Management
-  Alternative Solution
-  Excess Inventory Management