



**THE DATASHEET OF
IA1212S**



1 Watt

- Dual output unregulated
- SIP or DIP package
- Industry standard pinout
- 1.0kV DC isolation
- Operating temperature -40°C to +85°C
- MTBF >1.1Mhrs
- 3 year warranty

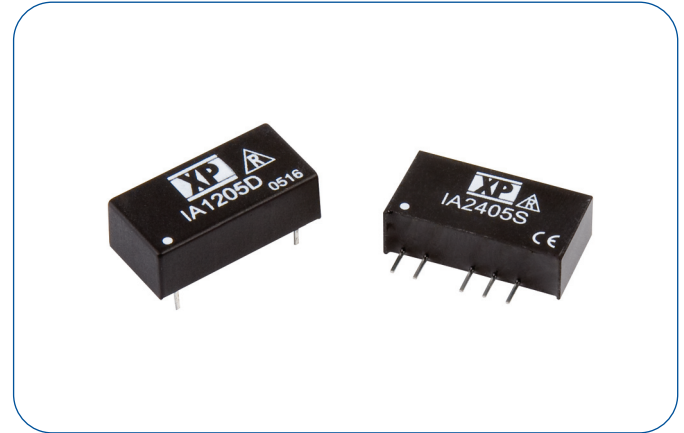

The IA series of compact SIP and DIP format DC-DC converters offer a cost effective, versatile and convenient solution to many applications within electronic circuits. With functional isolation, these dual output converters can be used for example in process control, instrumentation and logic circuits.

Dimensions:

IA SIP: 0.76 x 0.24 x 0.40" (19.3 x 6.09 x 10.16 mm)
 IA DIP: 0.80 x 0.40 x 0.25" (20.32 x 10.16 x 6.35 mm)

Models & Ratings

Input Voltage	Output Voltage	Output Current ⁽²⁾	Efficiency	Model Number ⁽¹⁾
3.3VDC	±5.0V	±100 mA	66%	IA0305S
5VDC	±3.3V	±151 mA	65%	IA0503S
	±5.0V	±100 mA	74%	IA0505S
	±9.0V	±55 mA	78%	IA0509S
	±12.0V	±42 mA	78%	IA0512S
	±15.0V	±33 mA	80%	IA0515S
	±24.0V	±21 mA	80%	IA0524S
12VDC	±3.3V	±151 mA	66%	IA1203S
	±5.0V	±100 mA	75%	IA1205S
	±9.0V	±55 mA	76%	IA1209S
	±12.0V	±42 mA	78%	IA1212S
	±15.0V	±33 mA	80%	IA1215S
	±24.0V	±21 mA	76%	IA1224S
24VDC	±3.3V	±151 mA	68%	IA2403S
	±5.0V	±100 mA	74%	IA2405S
	±9.0V	±55 mA	76%	IA2409S
	±12.0V	±42 mA	78%	IA2412S
	±15.0V	±33 mA	78%	IA2415S
	±24.0V	±21 mA	78%	IA2424S

Notes

1. Replace 'S' in model number with 'D' for DIP package.

2. Outputs power-trade.

Input

Characteristic	Minimum	Typical	Maximum	Units	Notes & Conditions
Input Voltage Range	2.97		3.63	VDC	3.3V nominal
	4.50		5.50		5V nominal
	10.80		13.20		12V nominal
	21.60		26.40		24V nominal

Output

Characteristic	Minimum	Typical	Maximum	Units	Notes & Conditions
Output Voltage				VDC	See Models and Ratings table
Set Accuracy			±3.0	%	At full load
Minimum Load					No load will not damage unit but may not meet all specifications
Line Regulation			1.2	%	For 1% Vin change
Load Regulation			±10	%	20 to 100% (3.3 Vout ±20%)
Ripple & Noise			75	mV pk-pk	20 MHz bandwidth. Measured using 0.47 µF ceramic capacitor.
Maximum Capacitive Load			100	µF	
Temperature Coefficient			0.02	%/°C	

General

Characteristic	Minimum	Typical	Maximum	Units	Notes & Conditions
Efficiency				%	See Models and Ratings table
Isolation: Input to Output	1000			VDC	
Isolation Resistance	10 ⁹			Ω	
Isolation Capacitance		60		pF	
Switching Frequency		80		kHz	Variable
Mean Time Between Failure		1.1		MHrs	MIL-HDBK-217F, +25 °C GB
Weight		0.00507 (2.3)		lb (g)	SIP
		0.00573 (2.6)			DIP
Water Wash	Use de-ionized water only				
Pin Material	Alloy 42 solder coated nickel iron				
Case Material	Non-conductive black plastic UL94V-0				
Potting Material	Epoxy UL94V-0 rated				
Solder Profile	Wavesolder 260°C max. 1.5mm from case 10s max				

Environmental

Characteristic	Minimum	Typical	Maximum	Units	Notes & Conditions
Operating Temperature	-40		+85	°C	
Storage Temperature	-40		+125	°C	
Case Temperature			+100	°C	
Cooling					Natural convection

EMC: Emissions

Phenomenon	Standard	Test Level	Notes & Conditions
Conducted	EN55032	Class A	Class B / External Components

EMC: Immunity

Phenomenon	Standard	Test Level	Criteria	Notes & Conditions
ESD	EN61000-4-2	±8 kV air discharge, ±6 kV contact	A	
Radiated	EN61000-4-3	10 V/m	A	
EFT/Burst	EN61000-4-4	±2 kV	A	With external components, see application notes
Surge	EN61000-4-5	±1 kV	A	With external components, see application notes
Conducted	EN61000-4-6	10 V rms	A	

Safety Approvals

Safety Agency	Safety Standard	Notes & Conditions
UL	UL60950-1 & CAN/CSA C22.2 No. 60950-1 UL62368-1 & CAN/CSA C22.2 No. 62368-1	
CE	Meets all applicable directives	
UKCA	Meets all applicable legislation	

Mechanical Details

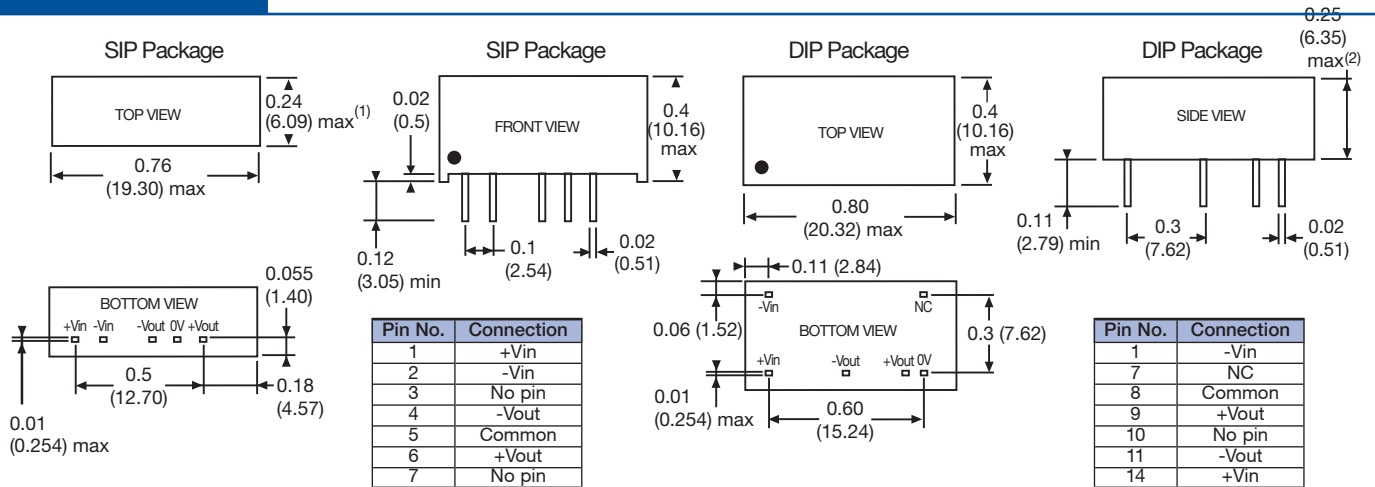

Notes

- All dimensions shown in inches (mm).
- Weight: SIP 0.00507 lbs (2.3 g)
DIP 0.00573 lbs (2.6 g)
- Recommended hole size for pins is 0.03 (0.8) diameter.

Application Notes

EMI Filter

Input filter components (C1, L, C2, C3) are used to help meet conducted emissions requirement for the module. These components should be mounted as close as possible to the module; and all leads should be minimized to decrease radiated noise.

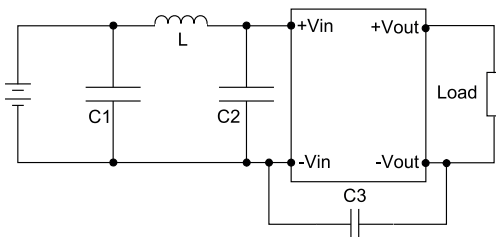

	C1	L	C2	C3
IA03XXX	1210, 2.2 μF/100V	18μH		
IA05XXX	1210, 2.2 μF/100V	18μH		
IA15XXX	1210, 2.2 μF/100V	18μH		
IA24XXX	1210, 2.2 μF/100V	18μH	1210, 2.2μF/100V	1206, 470pF/2kV

Ripple & Noise Reduction - Add optional electrolytic 10μF output capacitor

EFT/Surge Filter

Input filter components (C1, D1) are used to help meet IEC61000-4-4 and IEC61000-4-5.

SIP

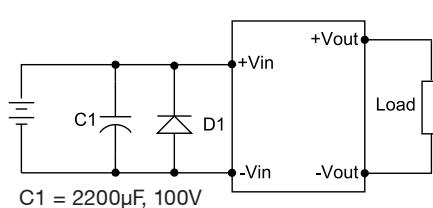

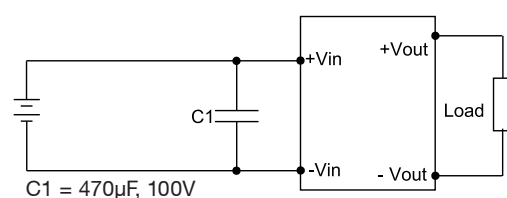

Input	D1
3.3V	SMAJ5A
5.0V	SMAJ6.5A
12.0V	SMAJ14A
15.0V	SMAJ18A
24.0V	SMAJ26A

DIP









Looking for pricing, stock, or lifecycle information?

Click below to explore more details on WIN SOURCE:

-  [View IA1212S on WIN SOURCE](#)
-  [XP Power Information](#)

Optimize Your Supply Chain with WIN SOURCE Solutions

-  Global Sourcing Solution
-  Obsolete Management
-  Cost Control Management
-  Shortage Management
-  Alternative Solution
-  Excess Inventory Management