



**THE DATASHEET OF
MXLDA3KP15A**





Surface Mount 3000 W Vertical Transient Voltage Suppressor Array

High-Reliability screening available in reference to MIL-PRF-19500

DESCRIPTION

The MDA series of 3000 W Transient Voltage Suppressors (TVSs) protects a variety of voltage-sensitive components from destruction or degradation. They can protect from secondary lightning effects per IEC61000-4-5 and class levels defined herein, or for inductive switching environments and induced RF protection. Since their response time is virtually instantaneous, they can also be used in protection from ESD and EFT per IEC61000-4-2 and IEC61000-4-4

Important: For the latest information, visit our website <http://www.microsemi.com>.

FEATURES

- Available in both unidirectional and bidirectional construction
- Selections for 6.0 to 40 volts standoff voltages (V_{WM})
- Optional upscreaming is available with various screening and conformance inspection options based on MIL-PRF-19500. Refer [Micronote 129](#) for more details on the screening options.
- High reliability with wafer fabrication and assembly lot traceability
- All parts surge tested
- Suppresses transients up to 3,000 W @ 10/1000 μ s (see [Figure 1](#))
- Moisture classification is Level 1 with no dry pack required per IPC/JEDEC J-STD-020B
- 3σ lot norm screening performed on standby current (I_D)

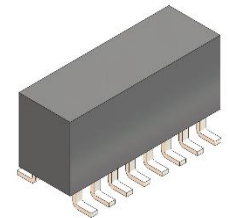

MDA3KPxxA

MSC – Lawrence

6 Lake Street,
Lawrence, MA 01841
Tel: 1-800-446-1158 or
(978) 620-2600
Fax: (978) 689-0803

APPLICATIONS / BENEFITS

- Suppresses transients up to 3000 watts @ 10/1000 μ s
- Protection from switching transients and induced RF
- Protection from ESD, and EFT per IEC 61000-4-2 and IEC 61000-4-4
- Secondary lightning protection per IEC61000-4-5 with 42 Ohms source impedance:
 - Class 1 – 4: MDA3KP6.0A to MDA3KP40A
- Secondary lightning protection per IEC61000-4-5 with 12 Ohms source impedance:
 - Class 1 – 3: MDA3KP6.0A to MDA3KP40A
 - Class 4: : MDA3KP6.0CA to MDA3KP18A
- Secondary lightning protection per IEC61000-4-5 with 2 Ohms source impedance:
 - Class 2: MDA3KP6.0A to MDA3KP40A
 - Class 3: MDA3KP6.0A to MDA3KP18A
 - Class 4: MDA3KP6.0A to MDA3KP9.0A

*See [Figure 3](#) for further temperature derating selection.

MSC – Ireland

Gort Road Business Park,
Ennis, Co. Clare, Ireland
Tel: +353 (0) 65 6840044
Fax: +353 (0) 65 6822298

Website:

www.microsemi.com

MAXIMUM RATINGS @ 25 °C unless otherwise specified

Parameters/Test Conditions	Symbol	Value	Unit
Junction and Storage Temperature	T _J and T _{STG}	-55 to +150	°C
Peak Pulse Power @ 10/1000 μs ⁽¹⁾	P _{PP}	3,000	W
t _{clamping} (0 volts to V _(BR) min)	Unidirectional	<100	ps
	Bidirectional	<5	ns
Forward Clamping Voltage @ 500 Amps ⁽²⁾	V _{FS}	4.0	V
Forward Surge Current ⁽²⁾	I _{FSM}	200	A
Solder Temperature @ 10 s	T _{SP}	260	°C

- Notes:** 1. Also see [figures 1 and 2](#). With impulse repetition rate (duty factor) of 0.05% or less.
 2. At 8.3 ms half-sine wave (unidirectional devices only).

MECHANICAL and PACKAGING

- CASE: Void-free transfer molded thermosetting epoxy body meeting UL94V-0
- TERMINALS: Tin-lead or annealed matte-tin plating readily solderable per MIL-STD-750, method 2026
- MARKING: Body marked with date code and part number. Pin 1 defined by a DOT on top of the package
- POLARITY: Odd number pins are cathodes of each TVS
- TRAYS: Consult factory for quantities.
- WEIGHT: Approximately 5 grams
- See [Package Dimensions](#) on last page.

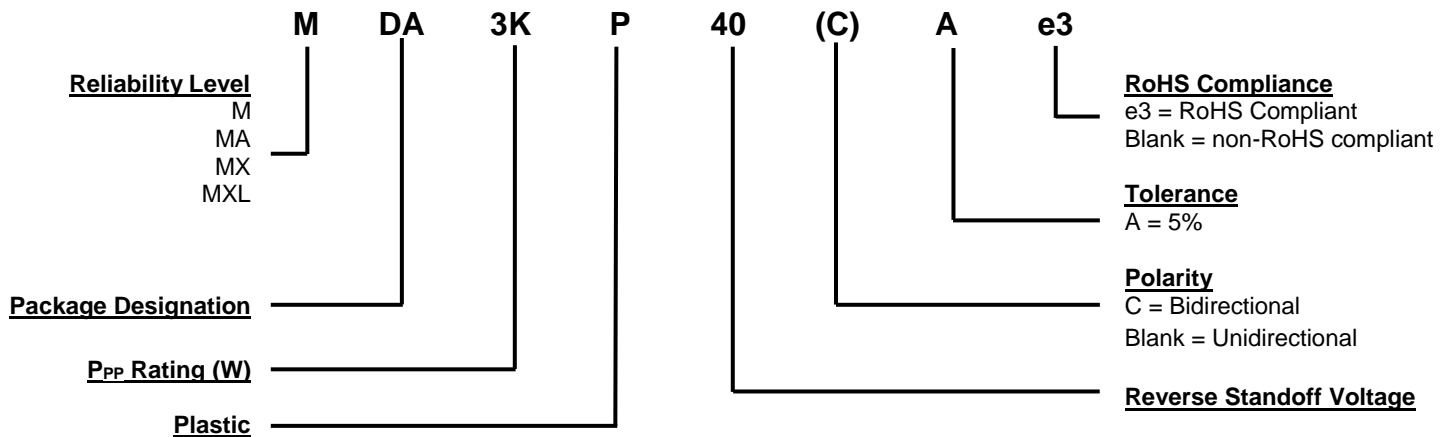

SYMBOLS & DEFINITIONS	
Symbol	Definition
$I_{(BR)}$	Breakdown Current: The current used for measuring breakdown voltage $V_{(BR)}$.
I_D	Standby Current: The current at the rated standoff voltage V_{WM} .
I_{PP}	Peak Impulse Current: The peak current during the impulse.
$V_{(BR)}$	Breakdown Voltage: The minimum voltage the device will exhibit at a specified current.
V_C	Clamping Voltage: Clamping voltage at I_{PP} (peak pulse current) at the specified pulse conditions (typically shown as maximum value).
V_{WM}	Rated Working Standoff Voltage: The maximum peak voltage that can be applied over the operating temperature range.

ELECTRICAL CHARACTERISTICS @ 25 °C unless otherwise stated

MICROSEMI PART NUMBER (see Note 1)	REVERSE STAND OFF VOLTAGE V_{WM}	BREAKDOWN VOLTAGE $V_{(BR)}$ @ $I_{(BR)}$ (Min – Max)		MAXIMUM CLAMPING VOLTAGE V_C @ I_{PP}	MAXIMUM STANDBY CURRENT I_D @ V_{WM}	MAXIMUM PEAK PULSE CURRENT I_{PP} (FIG. 2)
		V	mA			
MDA3KP6.0A	6	6.67 – 7.37	10	10.3	1000	291.3
MDA3KP6.5A	6.5	7.22 – 7.98	10	11.2	500	267.9
MDA3KP7.0A	7	7.78 – 8.6	10	12.0	200	250
MDA3KP7.5A	7.5	8.33 – 9.21	1	12.9	100	232.6
MDA3KP8.0A	8	8.89 – 9.83	1	13.6	50	220.6
MDA3KP8.5A	8.5	9.44 – 10.4	1	14.4	25	208.4
MDA3KP9.0A	9	10.0 – 11.1	1	15.4	10	194.8
MDA3KP10A	10	11.1 – 12.3	1	17.0	5	176.4
MDA3KP11A	11	12.2 – 13.5	1	18.2	5	164.8
MDA3KP12A	12	13.3 – 14.7	1	19.9	5	150.6
MDA3KP13A	13	14.4 – 15.9	1	21.5	5	139.4
MDA3KP14A	14	15.6 – 17.2	1	23.2	2	129.4
MDA3KP15A	15	16.7 – 18.5	1	24.4	2	123
MDA3KP16A	16	17.8 – 19.7	1	26.0	2	115.4
MDA3KP17A	17	18.9 – 20.9	1	27.6	2	106.6
MDA3KP18A	18	20.0 – 22.1	1	29.2	2	102.8
MDA3KP20A	20	22.2 – 24.5	1	32.4	2	92.6
MDA3KP22A	22	24.4 – 26.9	1	35.5	2	84.4
MDA3KP24A	24	26.7 – 29.5	1	38.9	2	77.2
MDA3KP26A	26	28.9 – 31.9	1	42.1	2	71.2
MDA3KP28A	28	31.1 – 34.4	1	45.4	2	66.0
MDA3KP30A	30	33.3 – 36.8	1	48.4	2	62.0
MDA3KP33A	33	36.7 – 40.6	1	53.3	2	56.2
MDA3KP36A	36	40.0 – 44.2	1	58.1	2	51.6
MDA3KP40A	40	44.4 – 49.1	1	64.5	2	46.4

NOTE 1: For bidirectional types, indicate a C suffix as shown on page 2 in "Part Nomenclature".

Transient Voltage Suppressors are normally selected with reverse standoff voltage V_{WM} , which should be equal to or greater than peak operating voltage.

GRAPHS

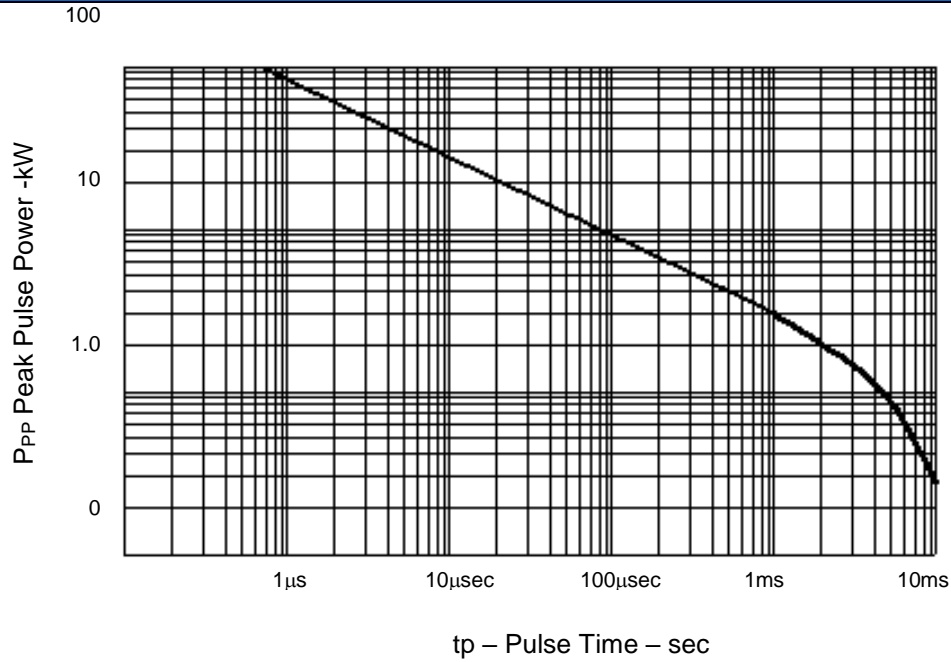
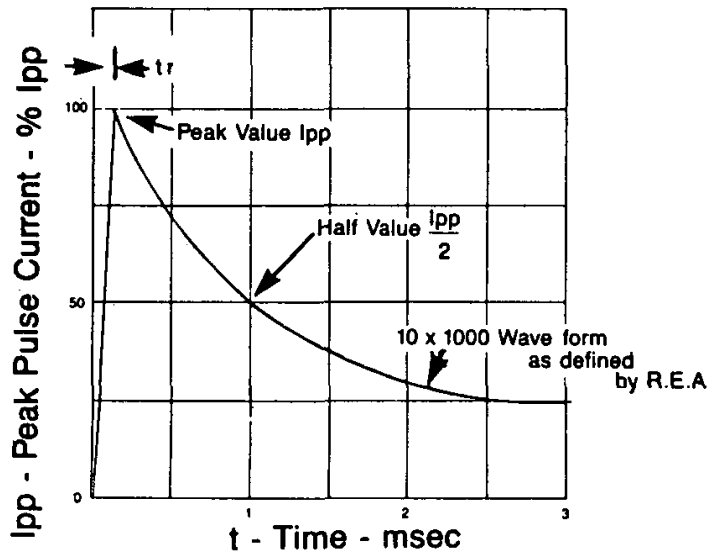

FIGURE 1
Peak Pulse Power vs. Pulse Time



Test waveform parameters: tr = 10 μs, tp = 1000 μs

Figure 2
Pulse Waveform

GRAPHS (continued)

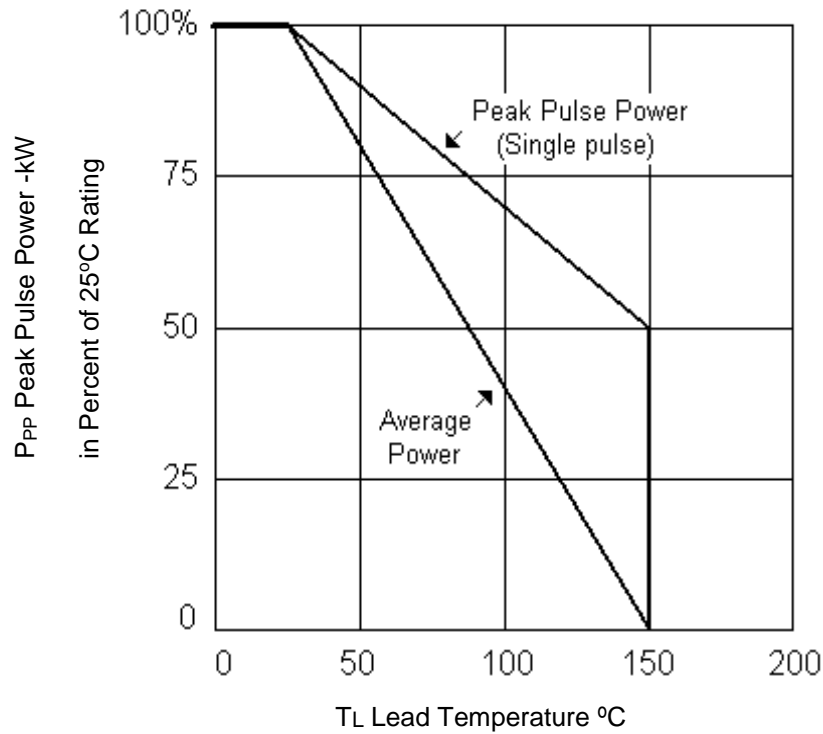
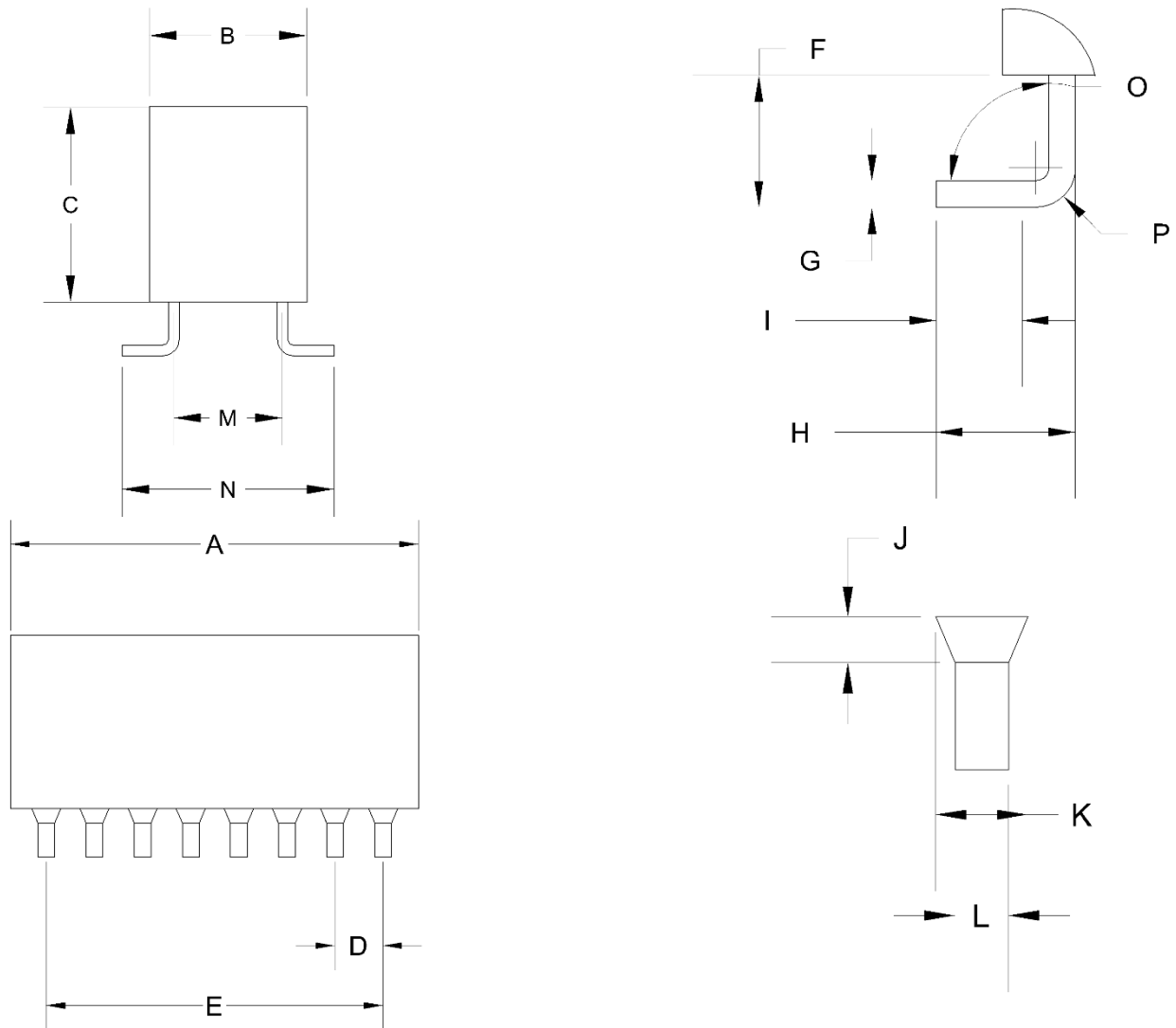
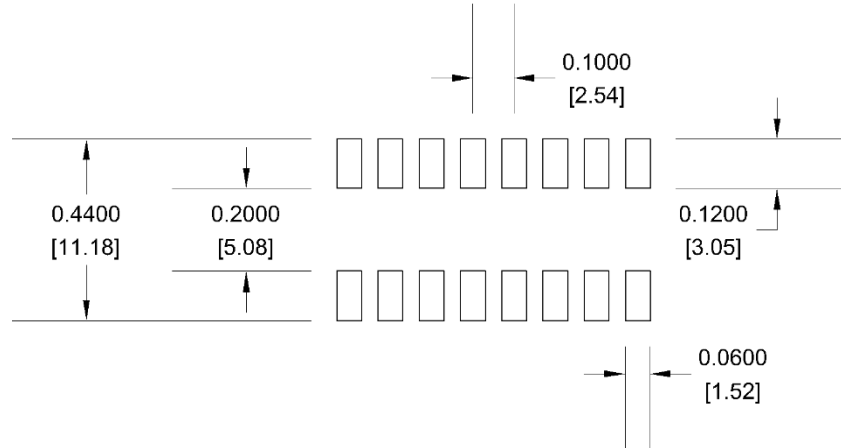
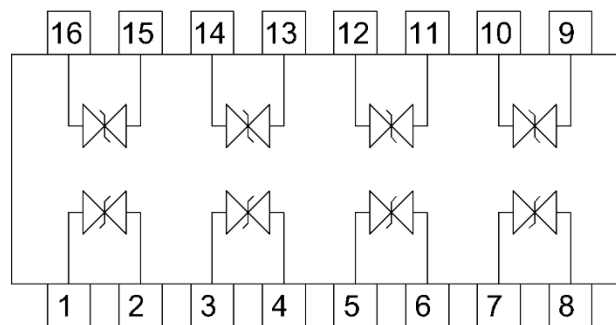
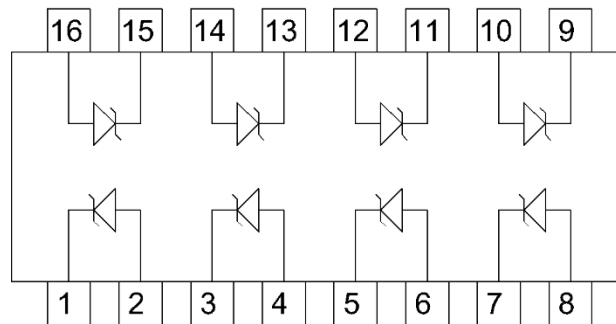

FIGURE 3
Derating Curve

PACKAGE DIMENSIONS

Ref.	Dimensions			
	Inch		Millimeters	
	Min	Max	Min	Max
A	0.828	0.868	21.03	22.05
B	0.270	0.310	6.86	7.87
C	0.340	0.380	8.64	9.65
D	0.100 (typ)		2.54 (typ)	
E	0.700 (typ)		17.78 (typ)	
F	0.095	0.105	2.41	2.67
G	0.015	0.025	0.38	0.64
H	0.105 (typ)		2.67 (typ)	
I	0.065 (typ)		1.65 (typ)	
J	0.025	0.035	0.64	0.89
K	0.055	0.065	1.40	1.65
L	0.030	0.040	0.76	1.02
M	0.195	0.205	4.95	5.21
N	0.370	0.410	9.40	10.41
O	89°	94°	89°	94°
P	0.025	0.035	0.64	0.89

PAD LAYOUT

DIODE LAYOUT

Looking for pricing, stock, or lifecycle information?

Click below to explore more details on WIN SOURCE:

- ⊖ [View MXLDA3KP15A](#) on WIN SOURCE
- ⊖ [Microchip Technology](#) Information

Optimize Your Supply Chain with WIN SOURCE Solutions

- ✓ Global Sourcing Solution
- ✓ Obsolete Management
- ✓ Cost Control Management
- ✓ Shortage Management
- ✓ Alternative Solution
- ✓ Excess Inventory Management