



Typical Applications

The HMC318MS8G / HMC318MS8GE is ideal for:

- UNII
- HiperLAN

Features

- LNA with 18 dB Gain Control
- +3V Operation
- Low Noise Figure: 2.5 dB
- No External Components
- Ultra Small 8 Lead MSOP:
14.8mm² x 1mm High

Functional Diagram

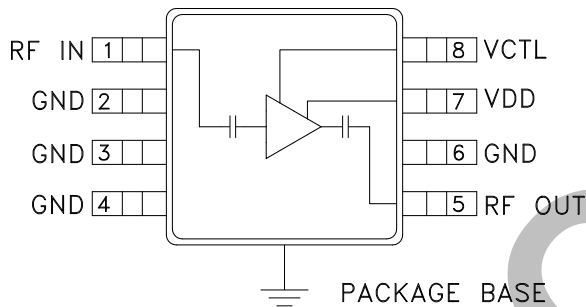

General Description

The HMC318MS8G & HMC318MS8GE are surface mount low cost C-band variable gain low noise amplifiers (VGLNA) that serve the full UNII and HiperLAN bands. The HMC318MS8G & HMC318MS8GE operate using a single positive supply that can be set between +3V or +5V. When a control voltage of 0V to +3V is applied, the gain of the amplifier will decrease while maintaining excellent return loss performance. A maximum gain of 9 dB is achieved when VCTL is set to 0V and a minimum gain of -9 dB is achieved when Vctl is set to +3V.

Electrical Specifications, $T_A = +25^\circ\text{C}$, $V_{DD} = +3\text{V}$

Parameter*	Min.	Typ.	Max.	Units
Frequency Range	5 - 6			GHz
Gain	6	9	12	dB
Gain Variation over Temperature		0.03	0.04	dB/°C
Gain Control Range	11	18	23	dB
Noise Figure		2.5	4.0	dB
Input Return Loss	6	12		dB
Output Return Loss	7	13		dB
Output Power for 1 dB Compression (P1dB)	-1	2		dBm
Output Third Order Intercept (OIP3)	10	13		dBm
Supply Current (I _{DD})		6	10	mA

* Specifications refer to the maximum gain state ($V_{ctl} = 0\text{V}$) unless otherwise noted.



Gain & Return Loss @ Vctl = 0V

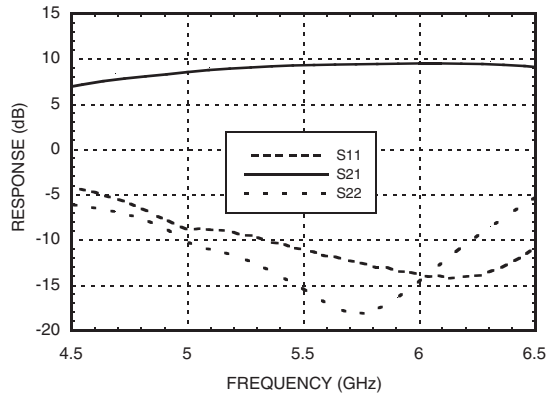

Gain over Control Range

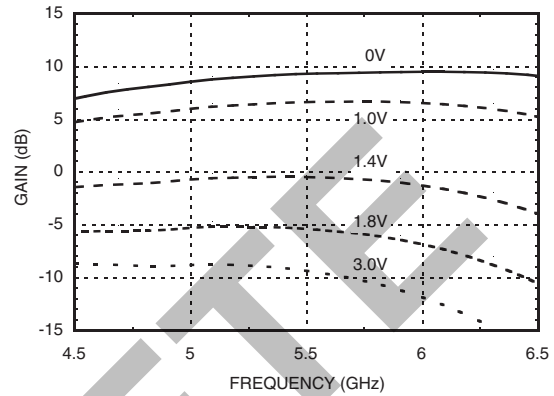

Gain vs. Temperature, Vctl = 0V

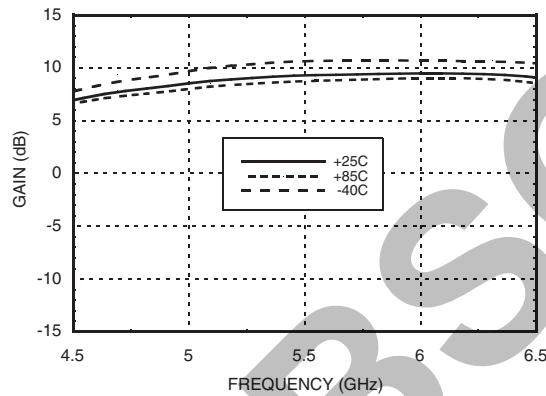

Noise Figure vs. Temperature, Vctl = 0V

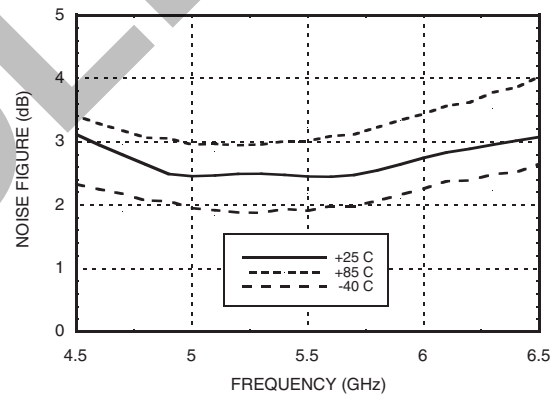

Input Return Loss vs. Temperature, Vctl = 0V

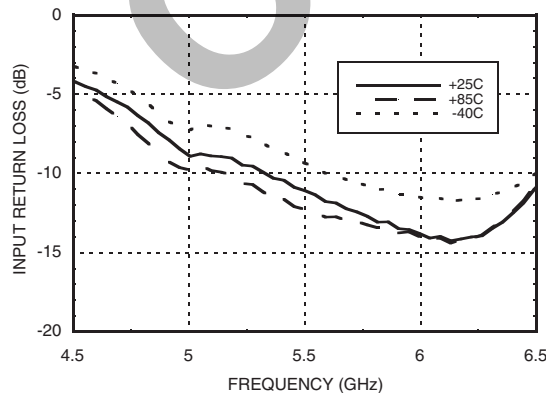

Output Return Loss vs. Temperature, Vctl = 0V

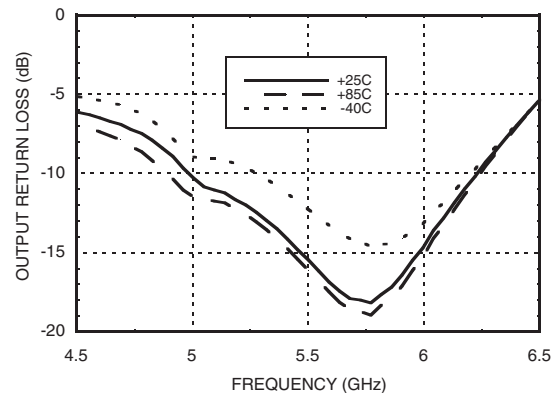

Information furnished by Analog Devices is believed to be accurate and reliable. However, no responsibility is assumed by Analog Devices for its use, nor for any infringements of patents or other rights of third parties that may result from its use. Specifications subject to change without notice. No license is granted by implication or otherwise under any patent or patent rights of Analog Devices. Trademarks and registered trademarks are the property of their respective owners.

For price, delivery, and to place orders: Analog Devices, Inc., One Technology Way, P.O. Box 9106, Norwood, MA 02062-9106 Phone: 781-329-4700 • Order online at www.analog.com Application Support: Phone: 1-800-ANALOG-D

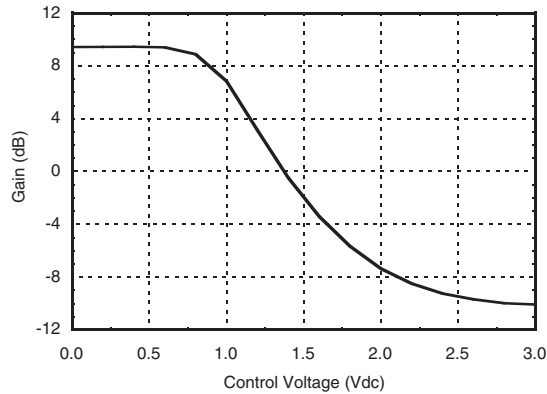
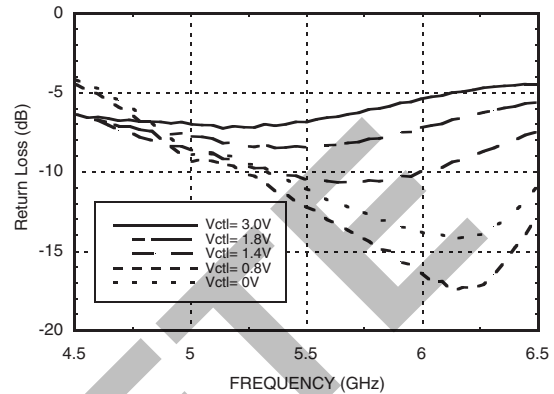
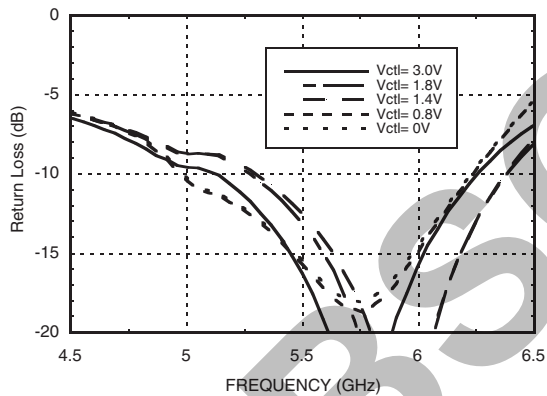
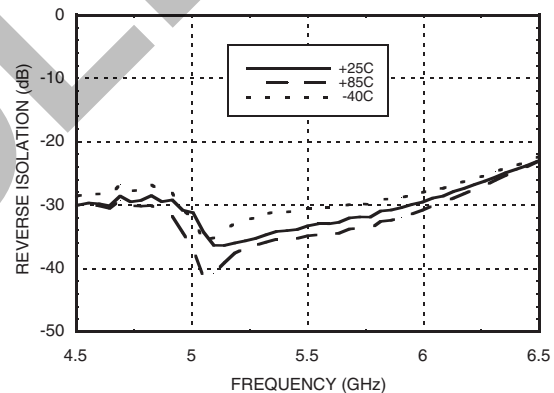
Gain vs. Control Voltage @ 5.8 GHz

Input Return Loss over Control Range

Output Return Loss over Control Range

Reverse Isolation vs. Temperature, Vctl = 0V

Noise Figure and OIP3 vs. Control Voltage

Frequency = 5.8 GHz		
VCTL	Noise Figure (dB)	OIP3 (dBm)*
0V	2.5	13.0
1.4V	4.5	1.2
3.0V	10.5	-6.7

*Two-tone input power = -20 dBm per tone.

Absolute Maximum Ratings

Drain Bias Voltage (Vdd)	+7.0 Vdc
Control Voltage Range (Vctl)	-0.2 to Vdd
RF Input Power (RFIN)(Vdd = +3.0 Vdc)	0 dBm
Channel Temperature	150 °C
Continuous Pdiss (T = 85 °C) (derate 9.76 mW/°C above 85 °C)	0.634 W
Thermal Resistance (channel to ground paddle)	102 °C/W
Storage Temperature	-65 to +150 °C
Operating Temperature	-40 to +85 °C
ESD Sensitivity (HBM)	Class 1A

Gain Control

Vctl (Vdc)	Gain State	Typical Ictl (uA)
0	Maximum	25
Vdd	Minimum	25

**ELECTROSTATIC SENSITIVE DEVICE
OBSERVE HANDLING PRECAUTIONS**



Outline Drawing

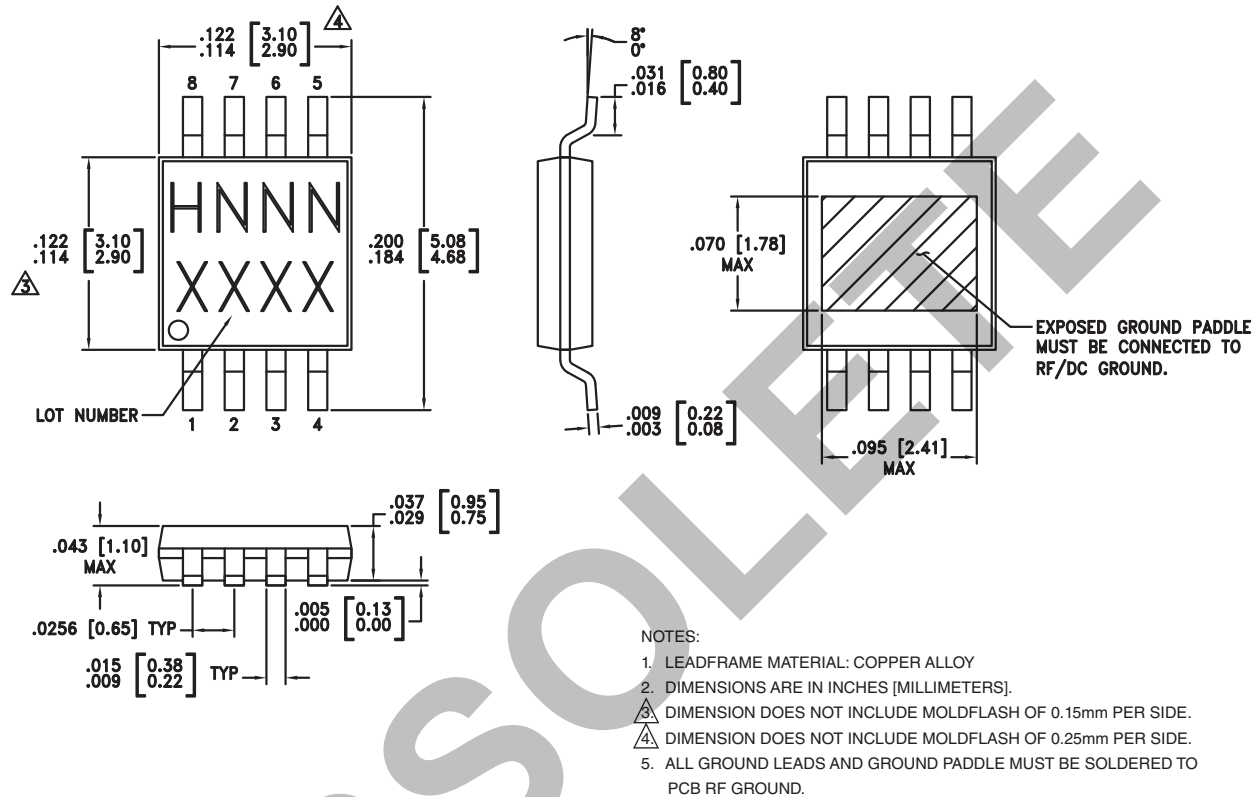

Package Information

Part Number	Package Body Material	Lead Finish	MSL Rating	Package Marking ^[3]
HMC318MS8G	Low Stress Injection Molded Plastic	Sn/Pb Solder	MSL1 ^[1]	H318 XXXX
HMC318MS8GE	RoHS-compliant Low Stress Injection Molded Plastic	100% matte Sn	MSL1 ^[2]	H318 XXXX

[1] Max peak reflow temperature of 235 °C

[2] Max peak reflow temperature of 260 °C

[3] 4-Digit lot number XXXX



Evaluation PCB

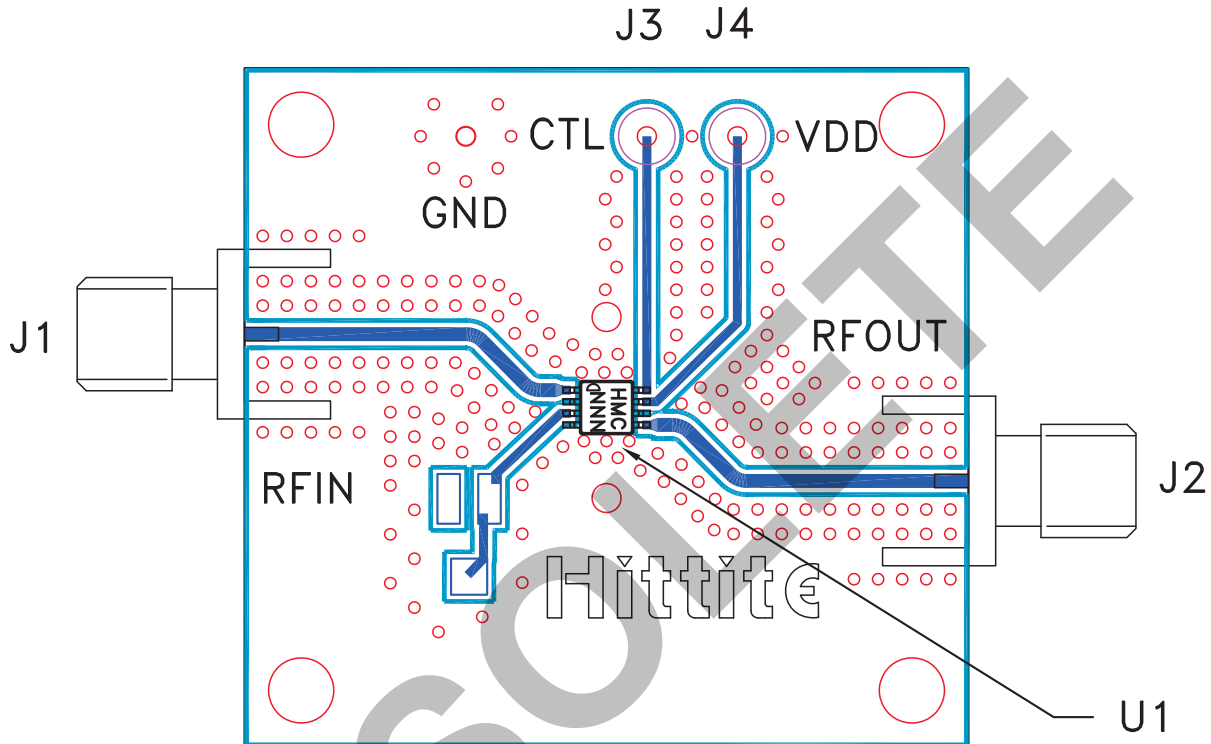

List of Materials for Evaluation PCB 104085 [1]

Item	Description
J1, J2	PCB Mount SMA Connector
J3, J4	DC Pin
U1	HMC318MS8G / HMC318MS8GE Amplifier
PCB [2]	Evaluation PCB 1.6" x 1.5"

[1] Reference this number when ordering complete evaluation PCB

[2] Circuit Board Material: Rogers 4350

The circuit board used in the final application should use RF circuit design techniques. Signal lines should have 50 ohm impedance while the package ground leads and exposed paddle should be connected directly to the ground plane similar to that shown. A sufficient number of via holes should be used to connect the top and bottom ground planes. The evaluation circuit board shown is available from Hittite upon request.



Notes:

v02.0607



HMC318MS8G / 318MS8GE

GaAs MMIC LOW NOISE AMPLIFIER
with AGC, 5 - 6 GHz

OBSOLETE

Looking for pricing, stock, or lifecycle information?

Click below to explore more details on WIN SOURCE:

-  [View HMC318MS8GETR on WIN SOURCE](#)
-  [Analog Devices Inc. Information](#)

Optimize Your Supply Chain with WIN SOURCE Solutions

-  Global Sourcing Solution
-  Obsolete Management
-  Cost Control Management
-  Shortage Management
-  Alternative Solution
-  Excess Inventory Management