



**THE DATASHEET OF
XMLK006B2D21**



XMLK006B2D21

Electronic pressure sensors, Pressure sensors XM, sensor XMLK, 0...6 bar, G 1/4 A, 4...20 mA, M12, set of 1



Main

Range of Product	OsiSense XM
Product or Component Type	Electronic pressure sensors
Pressure sensor type	Pressure transmitter
Pressure sensor name	XMLK
Electrical circuit type	Control circuit
Pressure Rating	87.02 psi (6 bar)
Local display	Without
Controlled fluid	Air 32...176 °F (0...80 °C) Fresh water 32...176 °F (0...80 °C)
Fluid connection type	G 1/4A (male) DIN 3852-E
Electrical connection	1 male connector M12 4 pins
[Us] rated supply voltage	24 V DC SELV 8...33 V
Current Consumption	< 20 mA
Type of output signal	Analogue
Analogue output function	4...20 mA, 2-wire
Quantity per Set	Set of 1
Type of Packing	Individual

Complementary

Pressure setting range	0.00...87.02 psi (0...6 bar)
Maximum permissible accidental pressure	174.05 psi (12 bar)
Destruction pressure	261.07 psi (18 bar)
Materials in contact with fluid	Ceramic Nitrile (NBR) Stainless steel type AISI 303
Operating position	Any position
Protection Type	Reverse polarity Load short-circuit
Electromagnetic compatibility	Electrostatic discharge immunity test EN/IEC 61000-4-2 8 kV air, 6 kV contact Susceptibility to electromagnetic fields EN/IEC 61000-4-3 10 V/m 80...1000 MHz Electrical fast transient/burst immunity test EN/IEC 61000-4-4 2 kV 1.2/50 µs shock waves immunity test EN/IEC 61000-4-5 500 V 12 Ohm, 1 kV 42 Ohm Radiated RF fields EN/IEC 61000-4-6 10 V 0.15...80 MHz Immunity to magnetic fields EN/IEC 61000-4-8 30 A/m 50 Hz
[Uimp] rated impulse withstand voltage	0.5 kV
Response time on output	< 5 ms
Measurement accuracy	+/- 1 % of the measuring range
Resolution	0.1 % of the measuring range
Drift of the sensitivity	+/- 0.04 % of measuring range/°K
Drift of the zero point	+/- 0.03 % of measuring range/°K
Long term stability	+/- 1 % of the measuring range
Mechanical durability	10000000 cycles
Net Weight	0.24 lb(US) (0.11 kg)
Diameter	1.42 in (36 mm)
Length	2.66 in (67.5 mm)
Scale type	Fixed differential

Environment

Standards	EN/IEC 61326-2-3 CE
Product Certifications	EAC UL 508 RCM CSA C22.2 No 14
Protective treatment	TC
Ambient Air Temperature for Operation	32...176 °F (0...80 °C)
Ambient Air Temperature for Storage	-13...176 °F (-25...80 °C)
Vibration resistance	20 gn 9...2000 Hz) EN/IEC 60068-2-6
Shock resistance	25 gn 11 ms EN/IEC 60068-2-27
IP degree of protection	IP65 conforming to EN/IEC 60529
NEMA Degree of Protection	NEMA 4



Ordering and shipping details

Category	21561-XMLK,XMLP PRESSURE TRANSMITTERS
Discount Schedule	DS2
GTIN	3389119048323
Nbr. of units in pkg.	1
Package weight(Lbs)	4.44 oz (126.0 g)
Returnability	No
Country of origin	CH

Packing Units

Unit Type of Package 1	PCE
Package 1 Height	1.65 in (4.2 cm)
Package 1 width	2.64 in (6.7 cm)
Package 1 Length	3.78 in (9.6 cm)
Unit Type of Package 2	S01
Number of Units in Package 2	24
Package 2 Weight	7.17 lb(US) (3.253 kg)
Package 2 Height	5.91 in (15 cm)
Package 2 width	5.91 in (15 cm)
Package 2 Length	15.75 in (40 cm)

Offer Sustainability

California proposition 65	WARNING: This product can expose you to chemicals including: Diisononyl phthalate (DINP), which is known to the State of California to cause cancer, and Di-isodecyl phthalate (DIDP), which is known to the State of California to cause birth defects or other reproductive harm. For more information go to www.P65Warnings.ca.gov
REACH Regulation	 REACH Declaration
EU RoHS Directive	Pro-active compliance (Product out of EU RoHS legal scope)  EU RoHS Declaration
Mercury free	Yes
RoHS exemption information	 Yes

Contractual warranty

Warranty	18 months
----------	-----------

Dimensions

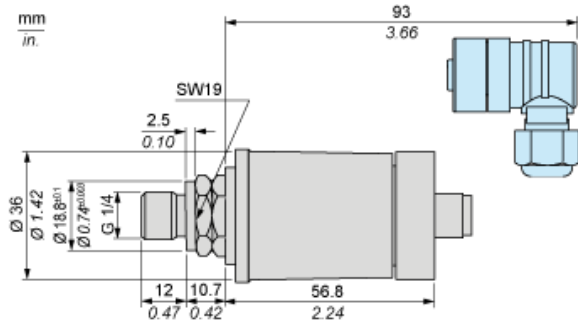

Wiring Diagram

2-Wire Technique (4-20 mA)

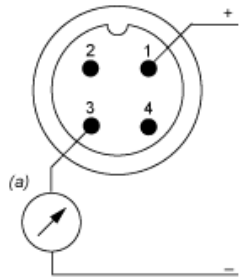

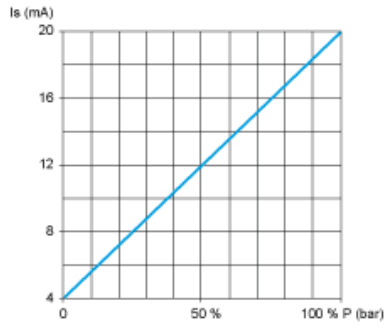

(a) I out

Output Curves



Looking for pricing, stock, or lifecycle information?

Click below to explore more details on WIN SOURCE:

-  [View XMLK006B2D21 on WIN SOURCE](#)
-  [Schneider Electric Information](#)

Optimize Your Supply Chain with WIN SOURCE Solutions

-  Global Sourcing Solution
-  Obsolete Management
-  Cost Control Management
-  Shortage Management
-  Alternative Solution
-  Excess Inventory Management