



**THE DATASHEET OF
CR0805-J/-4R7ELF**





Features

- RoHS compliant*
- Power rating at 70 °C: CR0603 - 0.10 W, CR0805 - 0.125 W, CR1206 - 0.25 W
- Tight tolerances of bottom electrode width
- Suitable for all types of soldering processes
- Three layer contacting process with nickel barrier prevents leaching and provides excellent solderability
- Paper tape on reel for automatic placement

CR0603/CR0805/CR1206 - Chip Resistors

Electrical Characteristics

Characteristic	Model CR0603	Model CR0805	Model CR1206
Power Rating @ 70 °C	1/10 W	1/8 W	1/4 W
Operating Temperature Range	-55 °C to +155 °C		
Derated to 0 Load at	+155 °C		
Maximum Working Voltage	75 V	150 V	200 V
Maximum Overload Voltage	150 V	300 V	400 V
Resistance Range: 1 % E-96 + E-24	10 ohms ≤ R ≤ 1M ohms ±100 PPM/°C		
Resistance Range: 5 % E-24	1M ohms < R ≤ 10M ohms ±200 PPM/°C		
Zero Ohm Jumper <0.05 ohm Rated / Maximum Current	1 A / 2.5 A	2 A / 5 A	2 A / 5 A

AEC-Q200: Contact Bourns to confirm availability.

For Standard Values Used in Capacitors, Inductors, and Resistors, [click here](#).

Chip Dimensions

Dimension	Model CR0603	Model CR0805	Model CR1206
L	$\frac{1.60 \pm 0.10}{(0.063 \pm 0.004)}$	$\frac{2.00 \pm 0.15}{(0.079 \pm 0.006)}$	$\frac{3.20 \pm 0.25}{(0.126 \pm 0.010)}$
W	$\frac{0.80 \pm 0.10}{(0.031 \pm 0.004)}$	$\frac{1.25 \pm 0.15}{(0.049 \pm 0.006)}$	$\frac{1.60 \pm 0.15}{(0.063 \pm 0.006)}$
H	$\frac{0.45 \pm 0.10}{(0.018 \pm 0.004)}$	$\frac{0.50 \pm 0.10}{(0.020 \pm 0.004)}$	$\frac{0.60 \pm 0.15}{(0.024 \pm 0.006)}$
I1	$\frac{0.30 \pm 0.20}{(0.012 \pm 0.008)}$	$\frac{0.40 \pm 0.20}{(0.016 \pm 0.008)}$	$\frac{0.50 \pm 0.25}{(0.020 \pm 0.010)}$
I2	$\frac{0.30 \pm 0.20}{(0.012 \pm 0.008)}$	$\frac{0.40 \pm 0.20}{(0.016 \pm 0.008)}$	$\frac{0.50 \pm 0.20}{(0.020 \pm 0.010)}$

DIMENSIONS: $\frac{\text{MM}}{\text{(INCHES)}}$

Derating Curve

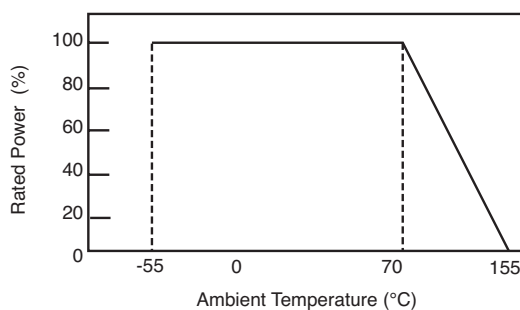

Characteristic Data

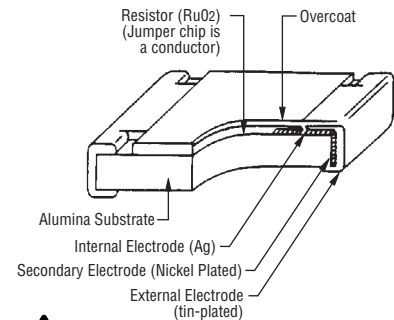
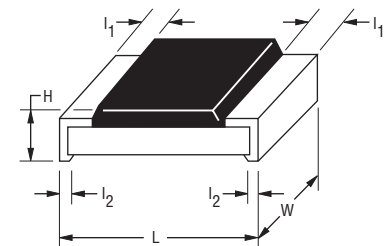

WARNING Cancer and Reproductive Harm
www.P65Warnings.ca.gov

*RoHS Directive 2002/95/EC Jan. 27, 2003 including annex and RoHS Recast 2011/65/EU June 8, 2011. Specifications are subject to change without notice. Users should verify actual device performance in their specific applications. The products described herein and this document are subject to specific legal disclaimers as set forth on the last page of this document, and at www.bourns.com/docs/legal/disclaimer.pdf.

CR0603/CR0805/CR1206 - Chip Resistors

BOURNS®

Performance Characteristics

Test	Procedure	Method	Specification	Test Limits ΔR	
				1 %	5 %
DC Resistance	--	MIL-STD-202 303 EIA RS-396 4.4	MIL-R-55342D 4.7.2	$\leq \pm 1 \%$	$\leq \pm 5.0 \%$
Low Temperature Operation	-55 °C, 1 hour "OFF"; 45 minutes "ON"	MIL-R-55342D 4.7.4 EIA RS-396 4.6	MIL-R-55342D 4.7.4	$\leq \pm(0.5 \% + 0.05 \Omega)$	$\leq \pm(1.0 \% + 0.05 \Omega)$
Short time Overload	Rated Voltage x 2.5, 5 seconds: CR0603: 100 V max. CR0805: 300 V max. CR1206: 400 V max.	MIL-R-55342D 4.7.5 EIA RS-396 4.7	MIL-R-55342D 4.7.5	$\leq \pm(1 \% + 0.05 \Omega)$	$\leq \pm(2 \% + 0.05 \Omega)$
High Temperature Exposure	+125 °C, 1000 hours	MIL-R-55342D 4.7.6 EIA RS-396 4.8	MIL-R-55342D 4.7.6	$\leq \pm(1.0 \% + 0.05 \Omega)$	$\leq \pm(2.0 \% + 0.1 \Omega)$
Resistance to Solder Heat	260 °C, 10 seconds	MIL-R-55342D 4.7.7	MIL-R-55342D 4.7.7	$\leq \pm(0.5 \% + 0.05 \Omega)$	$\leq \pm(1.0 \% + 0.05 \Omega)$
Moisture Resistance	90-98 % RH, 10 cycles	MIL-STD-202 106D EIA RS-396 4.9	MIL-R-55342D 4.7.8	$\leq \pm(0.5 \% + 0.05 \Omega)$	$\leq \pm(2.0 \% + 0.05 \Omega)$
Load Life	+70 °C; 1.5 hours "ON", 0.5 hours "OFF"; 1000 hours	MIL-STD-202 108 Condition D EIA RS-396 4.12	MIL-R-55342D 4.7.10	$\leq \pm(1.0 \% + 0.05 \Omega)$	$\leq \pm(3.0 \% + 0.1 \Omega)$
Solderability	+235 °C; 3 seconds	MIL-STD-202 208 EIA RS-396 4.11	MIL-R-55342D 4.7.11	$\geq 95 \%$ of area covered	
Terminal Strength	Pull Test	MIL-R-55342D 4.7.12	MIL-R-55342D 4.7.12	$\geq 500 \text{ g}$	
Current Noise	Quan-Tech Model 315B	MIL-STD-202 308	MIL-R-55342D 6.6	$R \leq 1 \text{ kW}; 1 \text{ mV/V max.}$ $R \leq 10 \text{ kW}; 3 \text{ mV/V max.}$ $R \leq 100 \text{ kW}; 6 \text{ mV/V max.}$ $R \leq 1 \text{ MW}; 10 \text{ mV/V max.}$	
Humidity, Steady State	+40 °C; 90-95 % RH, 1344 hours	MIL-STD-202 103B Condition D	--	$\leq \pm(2.5 \% + 0.05 \Omega)$	$\leq \pm(2.5 \% + 0.05 \Omega)$
Salt Spray	96 hours	MIL-STD-202 101D Condition A	--	$\leq \pm(1.0 \% + 0.2 \Omega)$	$\leq \pm(1.0 \% + 0.1 \Omega)$
Vibration	10-2000 Hz, 6 hours	MIL-STD-202 201A	--	$\leq \pm(0.5 \% + 0.1 \Omega)$	$\leq \pm(1.0 \% + 0.1 \Omega)$
Voltage Coefficient	--	MIL-STD-202 309	--	$\leq 100 \text{ ppm/V}$	
Insulation Resistance	Test potential: 500V CR0603: 100 V	MIL-STD-202 302 Condition B	--	$\geq 1 \text{ G}\Omega$	
Dielectric Withstanding Voltage	--	MIL-STD-202 301	--	CR0805, CR1206: $\geq 500 \text{ V}$ CR0603: $\geq 300 \text{ V}$	
Drop Test	1 m	MIL-STD-202 203B	--	$\leq \pm(0.5 \% + 0.1 \Omega)$	$\leq \pm(1 \% + 0.1 \Omega)$
Bending Test	5 mm/90 mm, 10 seconds	--	--	$\leq \pm(1 \% + 0.05 \Omega)$	$\leq \pm(1 \% + 0.05 \Omega)$
Thermal Shock	-55 °C for 30 minutes, +155 °C for 30 minutes, 5 cycles	IEC 60115-1-4.19	--	$\leq \pm(0.5 \% + 0.05 \Omega)$	$\leq \pm(1 \% + 0.05 \Omega)$
Resistance to Dry Heat	125 ± 5 °C for 96 ± 4 hours	IEC 60115-1-4.23.2	--	$\leq \pm(1 \% + 0.05 \Omega)$	$\leq \pm(2 \% + 0.1 \Omega)$

Specifications are subject to change without notice.

Users should verify actual device performance in their specific applications.

The products described herein and this document are subject to specific legal disclaimers as set forth on the last page of this document, and at www.bourns.com/docs/legal/disclaimer.pdf.

CR0603/CR0805/CR1206 - Chip Resistors

BOURNS®

Soldering Profile for RoHS Compliant Chip Resistors and Arrays

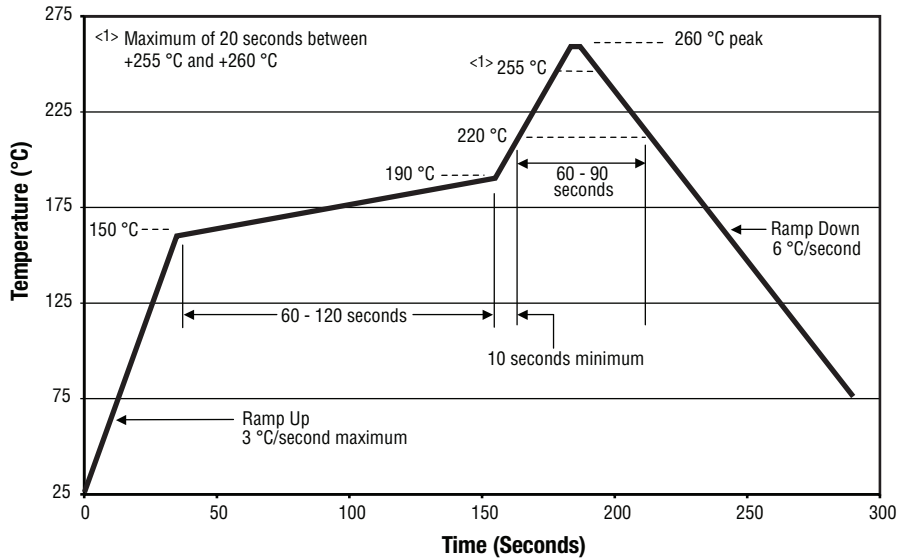

Packaging Dimensions (Conforms to EIA RS-481A)

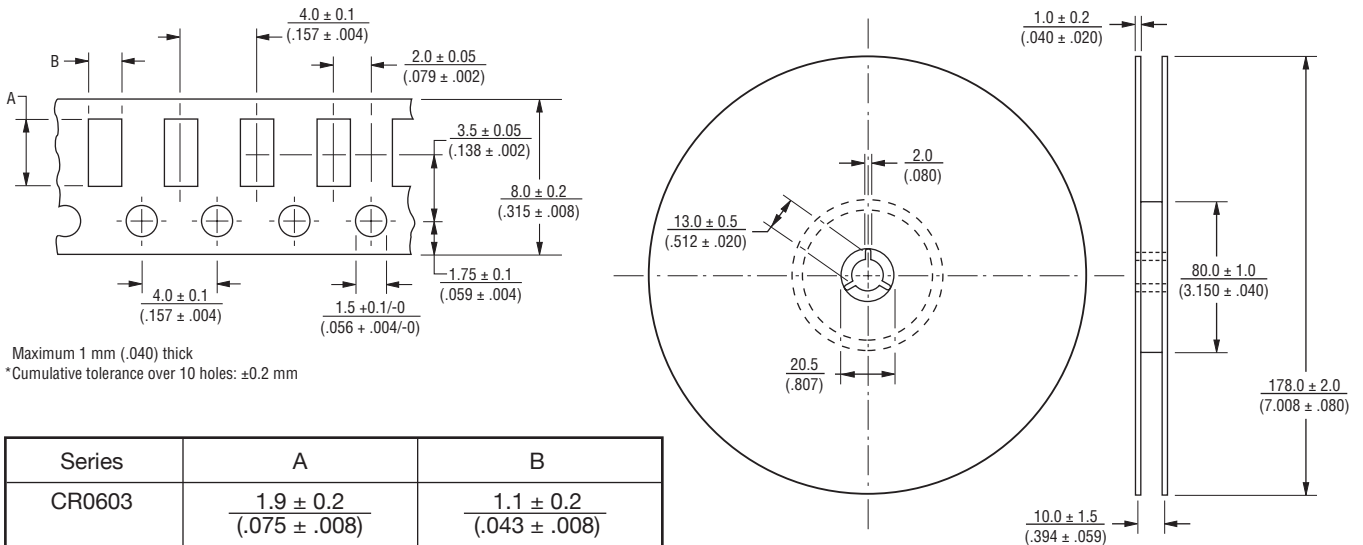

Series	A	B
CR0603	$\frac{1.9 \pm 0.2}{(.075 \pm .008)}$	$\frac{1.1 \pm 0.2}{(.043 \pm .008)}$
CR0805	$\frac{2.4 \pm 0.2}{(.094 \pm .008)}$	$\frac{1.65 \pm 0.2}{(.065 \pm .008)}$
CR1206	$\frac{3.57 \pm 0.2}{(.161 \pm .008)}$	$\frac{2.00 \pm 0.2}{(.079 \pm .008)}$

DIMENSIONS: $\frac{\text{MM}}{\text{(INCHES)}}$

Marking on reel: Part number, quantity, resistance value and tolerance, date code.

Specifications are subject to change without notice.

Users should verify actual device performance in their specific applications.

The products described herein and this document are subject to specific legal disclaimers as set forth on the last page of this document, and at www.bourns.com/docs/legal/disclaimer.pdf.

CR0603/CR0805/CR1206 - Chip Resistors

BOURNS®

Resistor Markings

CR0603
CR0805
CR1206



E-24 marking
Value = 10K ohms

CR0805
CR1206



E-96 marking
Value = 44.2K ohms

CR0603
EIA-96 Marking



1 % marking
Value = 12.4K ohms

Marking Explanation

- E-24: 3 digits, first two digits are significant, third digit is number of zeros.
Letter R is decimal point.
- E-96: 4 digits, first three digits are significant, fourth digit is number of zeros.
Letter R is decimal point.
0603 E-96: EIA-96 marking (see table below).

EIA-96 Marking for CR0603, 1 %

Code	R Value	Code	R Value	Code	R Value	Code	R Value	Code	R Value	Code	R Value	Code	R Value	Code	R Value
01	100	13	133	25	178	37	237	49	316	61	422	73	562	85	750
02	102	14	137	26	182	38	243	50	324	62	432	74	576	86	768
03	105	15	140	27	187	39	249	51	332	63	442	75	590	87	787
04	107	16	143	28	191	40	255	52	340	64	453	76	604	88	806
05	110	17	147	29	196	41	261	53	348	65	464	77	619	89	825
06	113	18	150	30	200	42	267	54	357	66	475	78	634	90	845
07	115	19	154	31	205	43	274	55	365	67	487	79	649	91	866
08	118	20	158	32	210	44	280	56	374	68	499	80	665	92	887
09	121	21	162	33	215	45	287	57	383	69	511	81	681	93	909
10	124	22	165	34	221	46	294	58	392	70	523	82	698	94	931
11	127	23	169	35	226	47	301	59	402	71	536	83	715	95	953
12	130	24	174	36	232	48	309	60	412	72	549	84	732	96	976

This table shows the first two digits for the three-digit EIA-96 part marking scheme. The third character is a letter multiplier:
Y=10⁻² X=10⁻¹ A=10⁰ B=10¹ C=10² D=10³ E=10⁴ F=10⁵

Specifications are subject to change without notice.

Users should verify actual device performance in their specific applications.

The products described herein and this document are subject to specific legal disclaimers as set forth on the last page of this document, and at www.bourns.com/docs/legal/disclaimer.pdf.

CR0603/CR0805/CR1206 - Chip Resistors

BOURNS®

How To Order

CR 1206 - F X - 8252 E LF

Model _____
(CR = Chip Resistor)

Size _____
• 0603
• 0805
• 1206

Resistance Tolerance _____
F = ±1 %Use with "X" TCR code only for values from 10 ohms through 1 megohm;
Use with "W" TCR code only for values from 1 megohm through 10 megohms.
J = ±5 %Use with "W" TCR code for values from 10 ohms through 10 megohms;
Use with "Z" TCR code for values above 10 megohms through 20 megohms;
Use with "/" TCR code for zero ohm (jumper) and values from 1 ohm through 9.1 ohms.

TCR (ppm/°C) _____
X = ±100
W = ±200
Z = ±400
/ = Used with "J" Resistance Tolerance code for zero ohm (jumper) and values from 1 ohm through 9.1 ohms.

Resistance Value _____
For 1 % Tolerance:
<100 ohms....."R" represents decimal point (example: 24R3 = 24.3 ohms).
≥100 ohms.....First three digits are significant, fourth digit represents number of zeros to follow (example: 8252 = 82.5k ohms).
For 5 % Tolerance:
<10 ohms....."R" represents decimal point (example: 4R7 = 4.7 ohms).
≥10 ohms.....First two digits are significant, third digit represents number of zeros to follow (example: 474 = 470k ohms; 000 = Jumper).

Packaging _____
E = Paper Tape (5,000 pcs.) on 7 " Plastic Reel

Termination _____
LF = Tin-plated (RoHS Compliant)

Legal Disclaimer Notice

BOURNS®

This legal disclaimer applies to purchasers and users of Bourns® products manufactured by or on behalf of Bourns, Inc. and its affiliates (collectively, “Bourns”).

Unless otherwise expressly indicated in writing, Bourns® products and data sheets relating thereto are subject to change without notice. Users should check for and obtain the latest relevant information and verify that such information is current and complete before placing orders for Bourns® products.

The characteristics and parameters of a Bourns® product set forth in its data sheet are based on laboratory conditions, and statements regarding the suitability of products for certain types of applications are based on Bourns’ knowledge of typical requirements in generic applications. The characteristics and parameters of a Bourns® product in a user application may vary from the data sheet characteristics and parameters due to (i) the combination of the Bourns® product with other components in the user’s application, or (ii) the environment of the user application itself. The characteristics and parameters of a Bourns® product also can and do vary in different applications and actual performance may vary over time. Users should always verify the actual performance of the Bourns® product in their specific devices and applications, and make their own independent judgments regarding the amount of additional test margin to design into their device or application to compensate for differences between laboratory and real world conditions.

Unless Bourns has explicitly designated an individual Bourns® product as meeting the requirements of a particular industry standard (e.g., ISO/TS 16949) or a particular qualification (e.g., UL listed or recognized), Bourns is not responsible for any failure of an individual Bourns® product to meet the requirements of such industry standard or particular qualification. Users of Bourns® products are responsible for ensuring compliance with safety-related requirements and standards applicable to their devices or applications.

Bourns® products are not recommended, authorized or intended for use in nuclear, lifesaving, life-critical or life-sustaining applications, nor in any other applications where failure or malfunction may result in personal injury, death, or severe property or environmental damage. Unless expressly and specifically approved in writing by two authorized Bourns representatives on a case-by-case basis, use of any Bourns® products in such unauthorized applications might not be safe and thus is at the user’s sole risk. Life-critical applications include devices identified by the U.S. Food and Drug Administration as Class III devices and generally equivalent classifications outside of the United States.

Bourns expressly identifies those Bourns® standard products that are suitable for use in automotive applications on such products’ data sheets in the section entitled “Applications.” Unless expressly and specifically approved in writing by two authorized Bourns representatives on a case-by-case basis, use of any other Bourns® standard products in an automotive application might not be safe and thus is not recommended, authorized or intended and is at the user’s sole risk. If Bourns expressly identifies a sub-category of automotive application in the data sheet for its standard products (such as infotainment or lighting), such identification means that Bourns has reviewed its standard product and has determined that if such Bourns® standard product is considered for potential use in automotive applications, it should only be used in such sub-category of automotive applications. Any reference to Bourns® standard product in the data sheet as compliant with the AEC-Q standard or “automotive grade” does not by itself mean that Bourns has approved such product for use in an automotive application.

Bourns® standard products are not tested to comply with United States Federal Aviation Administration standards generally or any other generally equivalent governmental organization standard applicable to products designed or manufactured for use in aircraft or space applications. Bourns expressly identifies Bourns® standard products that are suitable for use in aircraft or space applications on such products’ data sheets in the section entitled “Applications.” Unless expressly and specifically approved in writing by two authorized Bourns representatives on a case-by-case basis, use of any other Bourns® standard product in an aircraft or space application might not be safe and thus is not recommended, authorized or intended and is at the user’s sole risk.

The use and level of testing applicable to Bourns® custom products shall be negotiated on a case-by-case basis by Bourns and the user for which such Bourns® custom products are specially designed. Absent a written agreement between Bourns and the user regarding the use and level of such testing, the above provisions applicable to Bourns® standard products shall also apply to such Bourns® custom products.

Users shall not sell, transfer, export or re-export any Bourns® products or technology for use in activities which involve the design, development, production, use or stockpiling of nuclear, chemical or biological weapons or missiles, nor shall they use Bourns® products or technology in any facility which engages in activities relating to such devices. The foregoing restrictions apply to all uses and applications that violate national or international prohibitions, including embargos or international regulations. Further, Bourns® products and Bourns technology and technical data may not under any circumstance be exported or re-exported to countries subject to international sanctions or embargoes. Bourns® products may not, without prior authorization from Bourns and/or the U.S. Government, be resold, transferred, or re-exported to any party not eligible to receive U.S. commodities, software, and technical data.

To the maximum extent permitted by applicable law, Bourns disclaims (i) any and all liability for special, punitive, consequential, incidental or indirect damages or lost revenues or lost profits, and (ii) any and all implied warranties, including implied warranties of fitness for particular purpose, non-infringement and merchantability.



For your convenience, copies of this Legal Disclaimer Notice with German, Spanish, Japanese, Traditional Chinese and Simplified Chinese bilingual versions are available at:

Web Page: <http://www.bourns.com/legal/disclaimers-terms-and-policies>

PDF: <http://www.bourns.com/docs/Legal/disclaimer.pdf>

Looking for pricing, stock, or lifecycle information?

Click below to explore more details on WIN SOURCE:

-  [View CR0805-J/-4R7ELF on WIN SOURCE](#)
-  [Bourns Inc. Information](#)

Optimize Your Supply Chain with WIN SOURCE Solutions

-  Global Sourcing Solution
-  Obsolete Management
-  Cost Control Management
-  Shortage Management
-  Alternative Solution
-  Excess Inventory Management