

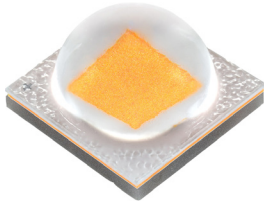

**THE DATASHEET OF
XMLBWT-00-0000-0000U2051**



XLamp® XM-L2 LEDs



PRODUCT DESCRIPTION

The XLamp® XM-L2 LED builds on the unprecedented performance of the original XM-L, increasing lumen output up to 20% while providing a single die LED point source for precise optical control. The XM-L2 LED shares the same mechanical and optical footprint as the original XM-L, providing a seamless upgrade path and shortened design cycle.

XLamp XM-L2 LEDs are the ideal choice for lighting applications where high light output and maximum efficacy are required, such as LED light bulbs, outdoor lighting, portable lighting, indoor lighting and solar-powered lighting.

FEATURES

- Available in white, 70-CRI white, 80-CRI white, and 90-CRI white
- ANSI-compatible chromaticity bins
- Binned at 85 °C
- Maximum drive current: 3000 mA
- Low thermal resistance: 0.75 °C/W
- Wide viewing angle: 120°
- Unlimited floor life at ≤ 30 °C/85% RH
- Reflow solderable - JEDEC J-STD-020C
- Electrically neutral thermal path
- RoHS and REACH compliant
- UL® recognized component (E349212)



Cree LED / 4001 E. Hwy. 54, Suite 2000 / Durham, NC 27709 USA / +1.919.313.5330 / www.cree-led.com

TABLE OF CONTENTS

Characteristics	3
Order Codes Suggested for New Designs	4
Relative Spectral Power Distribution	11
Relative Flux vs. Junction Temperature.....	11
Electrical Characteristics.....	12
Relative Flux vs. Current.....	12
Relative Chromaticity vs. Current.....	13
Relative Chromaticity vs. Temperaturee.....	13
Typical Spatial Distribution.....	14
Thermal Design.....	14
Performance Groups – Luminous Flux.....	15
Performance Groups – Chromaticity.....	15
Standard Cool White Kits Plotted on ANSI Standard Chromaticity Regions.....	19
Standard Warm and Neutral White Kits Plotted on ANSI Standard Chromaticity Regions.....	20
Standard Chromaticity Kits	22
Bin and Order Code Formats.....	23
Reflow Soldering Characteristics.....	24
Notes	25
Mechanical Dimensions	27
Tape and Reel.....	28
Packaging.....	30
Appendix - Order Codes Not For New Designs	31

CHARACTERISTICS

Characteristics	Unit	Minimum	Typical	Maximum
Thermal resistance, junction to solder point*	°C/W		0.75	
Viewing angle (FWHM)	degrees		120	
Temperature coefficient of voltage	mV/°C		-1.3	
ESD withstand voltage (HBM per Mil-Std-883D)			Class 3B	
DC forward current	mA			3000
Reverse voltage	V			1
Forward voltage (@ 700 mA, 85 °C)	V		2.72	3.15
Forward voltage (@ 1500 mA, 85 °C)	V		2.84	
Forward voltage (@ 3000 mA, 85 °C)	V		3.02	
LED junction temperature	°C			150

Note

- * Thermal resistance measurement was performed per JEDEC JESD51-14 standard. See the [Thermal Resistance Measurement application note](#) for more details.

ORDER CODES SUGGESTED FOR NEW DESIGNS (T_J = 85 °C)

The following tables provide order codes for XLamp XM-L2 LEDs. For a complete description of the order-code nomenclature, please consult the Bin and Order Code Formats section (page 23).

Chromaticity		Minimum Luminous Flux (lm) @ 700 mA*			Calculated Minimum Luminous Flux (lm) @ 85 °C**			Order Codes
Kit	CCT	Code	Flux (lm) @ 85 °C	Flux (lm) @ 25 °C*	1000 mA	1500 mA	2000 mA	65 CRI Typical
ANSI Cool White (5000 K – 8300 K)								
51	6200 K	U4	340	370	469	667	848	XMLBWT-00-0000-0000U4051
		U3	320	348	441	628	798	XMLBWT-00-0000-0000U3051
		U2	300	327	414	589	749	XMLBWT-00-0000-0000U2051
		T6	280	305	386	549	699	XMLBWT-00-0000-0000T6051
53	6000 K	U4	340	370	469	667	848	XMLBWT-00-0000-0000U4053
		U3	320	348	441	628	798	XMLBWT-00-0000-0000U3053
		U2	300	327	414	589	749	XMLBWT-00-0000-0000U2053
		T6	280	305	386	549	699	XMLBWT-00-0000-0000T6053
50	6200 K	U4	340	370	469	667	848	XMLBWT-00-0000-0000U4050
		U3	320	348	441	628	798	XMLBWT-00-0000-0000U3050
		U2	300	327	414	589	749	XMLBWT-00-0000-0000U2050
		T6	280	305	386	549	699	XMLBWT-00-0000-0000T6050
E1	6500 K	U4	340	370	469	667	848	XMLBWT-00-0000-0000U40E1
		U3	320	348	441	628	798	XMLBWT-00-0000-0000U30E1
		U2	300	327	414	589	749	XMLBWT-00-0000-0000U20E1
		T6	280	305	386	549	699	XMLBWT-00-0000-0000T60E1
E2	5700 K	U4	340	370	469	667	848	XMLBWT-00-0000-0000U40E2
		U3	320	348	441	628	798	XMLBWT-00-0000-0000U30E2
		U2	300	327	414	589	749	XMLBWT-00-0000-0000U20E2
		T6	280	305	386	549	699	XMLBWT-00-0000-0000T60E2

Notes

- For additional order codes NOT recommended for new designs please see the Appendix section starting on page 31.
- Cree LED maintains a tolerance of ±7% on flux and power measurements, ±0.005 on chromaticity (CCx, CCy) measurements and a tolerance of ±2 on CRI measurements. See the Measurements section (page 25).
- XLamp XM-L2 LED order codes specify only a minimum flux bin and not a maximum. Cree LED may ship reels in flux bins higher than the minimum specified by the order code without advance notice. Shipments will always adhere to the chromaticity bin restrictions specified by the order code.

* Flux values @ 25 °C are calculated and for reference only.

** Calculated flux values are for reference only.

ORDER CODES SUGGESTED FOR NEW DESIGNS (T_J = 85 °C) - CONTINUED

Chromaticity		Minimum Luminous Flux (lm) @ 700 mA*			Calculated Minimum Luminous Flux (lm) @ 85 °C**			Order Codes		
Kit	CCT	Code	Flux (lm) @ 85 °C	Flux (lm) @ 25 °C*	1000 mA	1500 mA	2000 mA	70 CRI Minimum	75 CRI Typical	80 CRI Minimum
ANSI Neutral White (3700 K – 5000 K)										
E3	5000 K	U4	340	370	469	667	848	XMLBWT-00-0000-000BU40E3	XMLBWT-00-0000-000LU40E3	
		U3	320	348	441	628	798	XMLBWT-00-0000-000BU30E3	XMLBWT-00-0000-000LU30E3	
		U2	300	327	414	589	749	XMLBWT-00-0000-000BU20E3	XMLBWT-00-0000-000LU20E3	
F4	4750 K	U4	340	370	469	667	848	XMLBWT-00-0000-000BU40F4		
		U3	320	348	441	628	798	XMLBWT-00-0000-000BU30F4	XMLBWT-00-0000-000LU30F4	
		U2	300	327	414	589	749	XMLBWT-00-0000-000BU20F4	XMLBWT-00-0000-000LU20F4	
		T6	280	305	386	549	699		XMLBWT-00-0000-000LT60F4	
E4	4500 K	U4	340	370	469	667	848	XMLBWT-00-0000-000BU40E4		
		U3	320	348	441	628	798	XMLBWT-00-0000-000BU30E4	XMLBWT-00-0000-000LU30E4	
		U2	300	327	414	589	749	XMLBWT-00-0000-000BU20E4	XMLBWT-00-0000-000LU20E4	
		T6	280	305	386	549	699		XMLBWT-00-0000-000LT60E4	
F5	4250 K	U4	340	370	469	667	848	XMLBWT-00-0000-000BU40F5		
		U3	320	348	441	628	798	XMLBWT-00-0000-000BU30F5	XMLBWT-00-0000-000LU30F5	
		U2	300	327	414	589	749	XMLBWT-00-0000-000BU20F5	XMLBWT-00-0000-000LU20F5	
		T6	280	305	386	549	699		XMLBWT-00-0000-000LT60F5	
E5	4000 K	U4	340	370	469	667	848	XMLBWT-00-0000-000BU40E5		
		U3	320	348	441	628	798	XMLBWT-00-0000-000BU30E5	XMLBWT-00-0000-000LU30E5	XMLBWT-00-0000-000HU30E5
		U2	300	327	414	589	749	XMLBWT-00-0000-000BU20E5	XMLBWT-00-0000-000LU20E5	XMLBWT-00-0000-000HU20E5
		T6	280	305	386	549	699		XMLBWT-00-0000-000LT60E5	XMLBWT-00-0000-000HT60E5

Notes

- For additional order codes NOT recommended for new designs please see the Appendix section starting on page 31.
- Cree LED maintains a tolerance of ±7% on flux and power measurements, ±0.005 on chromaticity (CCx, CCy) measurements and a tolerance of ±2 on CRI measurements. See the Measurements section (page 25).
- XLamp XM-L2 LED order codes specify only a minimum flux bin and not a maximum. Cree LED may ship reels in flux bins higher than the minimum specified by the order code without advance notice. Shipments will always adhere to the chromaticity bin restrictions specified by the order code.

* Flux values @ 25 °C are calculated and for reference only.

** Calculated flux values are for reference only.

ORDER CODES SUGGESTED FOR NEW DESIGNS (T_j = 85 °C) - CONTINUED

Chromaticity		Minimum Luminous Flux (lm) @ 700 mA*			Calculated Minimum Luminous Flux (lm) @ 85 °C**			Order Codes		
Kit	CCT	Code	Flux (lm) @ 85 °C	Flux (lm) @ 25 °C*	1000 mA	1500 mA	2000 mA	70 CRI Minimum	75 CRI Typical	80 CRI Minimum
ANSI Neutral White (3700 K – 5000 K)										
Z5	4000 K	U3	320	348	441	628	798		XMLBWT-00-0000-000LU30Z5	XMLBWT-00-0000-000HU30Z5
		U2	300	327	414	589	749		XMLBWT-00-0000-000LU20Z5	XMLBWT-00-0000-000HU20Z5
		T6	280	305	386	549	699		XMLBWT-00-0000-000LT60Z5	XMLBWT-00-0000-000HT60Z5

Notes

- For additional order codes NOT recommended for new designs please see the Appendix section starting on page 31.
- Cree LED maintains a tolerance of ±7% on flux and power measurements, ±0.005 on chromaticity (CCx, CCy) measurements and a tolerance of ±2 on CRI measurements. See the Measurements section (page 25).
- XLamp XM-L2 LED order codes specify only a minimum flux bin and not a maximum. Cree LED may ship reels in flux bins higher than the minimum specified by the order code without advance notice. Shipments will always adhere to the chromaticity bin restrictions specified by the order code.

* Flux values @ 25 °C are calculated and for reference only.

** Calculated flux values are for reference only.

ORDER CODES SUGGESTED FOR NEW DESIGNS (T_J = 85 °C) - CONTINUED

Chromaticity		Minimum Luminous Flux (lm) @ 700 mA*			Calculated Minimum Luminous Flux (lm) @ 85 °C**			Order Codes		
Kit	CCT	Code	Flux (lm) @ 85 °C	Flux (lm) @ 25 °C*	1000 mA	1500 mA	2000 mA	80 CRI Typical	80 CRI Minimum	90 CRI Minimum
ANSI Warm White (2700 K - 3750 K)										
F6	3750 K	U2	300	327	414	589	749	XMLBWT-00-0000-000LU20F6	XMLBWT-00-0000-000HU20F6	
		T6	280	305	386	549	699	XMLBWT-00-0000-000LT60F6	XMLBWT-00-0000-000HT60F6	
		T5	260	283	359	510	649	XMLBWT-00-0000-000LT50F6	XMLBWT-00-0000-000HT50F6	
E6	3500 K	U2	300	327	414	589	749	XMLBWT-00-0000-000LU20E6	XMLBWT-00-0000-000HU20E6	
		T6	280	305	386	549	699	XMLBWT-00-0000-000LT60E6	XMLBWT-00-0000-000HT60E6	
		T5	260	283	359	510	649	XMLBWT-00-0000-000LT50E6	XMLBWT-00-0000-000HT50E6	
Z6	3500 K	U2	300	327	414	589	749	XMLBWT-00-0000-000LU20Z6	XMLBWT-00-0000-000HU20Z6	
		T6	280	305	386	549	699	XMLBWT-00-0000-000LT60Z6	XMLBWT-00-0000-000HT60Z6	
		T5	260	283	359	510	649	XMLBWT-00-0000-000LT50Z6	XMLBWT-00-0000-000HT50Z6	
F7	3250 K	U2	300	327	414	589	749	XMLBWT-00-0000-000LU20F7	XMLBWT-00-0000-000HU20F7	
		T6	280	305	386	549	699	XMLBWT-00-0000-000LT60F7	XMLBWT-00-0000-000HT60F7	
		T5	260	283	359	510	649	XMLBWT-00-0000-000LT50F7	XMLBWT-00-0000-000HT50F7	

Notes

- For additional order codes NOT recommended for new designs please see the Appendix section starting on page 31.
- Cree LED maintains a tolerance of ±7% on flux and power measurements, ±0.005 on chromaticity (CCx, CCy) measurements and a tolerance of ±2 on CRI measurements. See the Measurements section (page 25).
- XLamp XM-L2 LED order codes specify only a minimum flux bin and not a maximum. Cree LED may ship reels in flux bins higher than the minimum specified by the order code without advance notice. Shipments will always adhere to the chromaticity bin restrictions specified by the order code.

* Flux values @ 25 °C are calculated and for reference only.

** Calculated flux values are for reference only.

ORDER CODES SUGGESTED FOR NEW DESIGNS (T_J = 85 °C) - CONTINUED

Chromaticity		Minimum Luminous Flux (lm) @ 700 mA*			Calculated Minimum Luminous Flux (lm) @ 85 °C**			Order Codes		
Kit	CCT	Code	Flux (lm) @ 85 °C	Flux (lm) @ 25 °C*	1000 mA	1500 mA	2000 mA	80 CRI Typical	80 CRI Minimum	90 CRI Minimum
ANSI Warm White (2700 K - 3750 K)										
E7	3000 K	U2	300	327	414	589	749	XMLBWT-00-0000-000LU20E7	XMLBWT-00-0000-000HU20E7	
		T6	280	305	386	549	699	XMLBWT-00-0000-000LT60E7	XMLBWT-00-0000-000HT60E7	
		T5	260	283	359	510	649	XMLBWT-00-0000-000LT50E7	XMLBWT-00-0000-000HT50E7	
		T4	240	261	331	471	599			
		T3	220	239	303	432	549			
		T2	200	218	276	392	499			XMLBWT-00-0000-000UT20E7
		S6	182	198	251	357	454			XMLBWT-00-0000-000US60E7
		S5	172	187	237	337	429			XMLBWT-00-0000-000US50E7
		S4	164	179	226	322	409			XMLBWT-00-0000-000US40E7
Z7	3000 K	U2	300	327	414	589	749	XMLBWT-00-0000-000LU20Z7	XMLBWT-00-0000-000HU20Z7	
		T6	280	305	386	549	699	XMLBWT-00-0000-000LT60Z7	XMLBWT-00-0000-000HT60Z7	
		T5	260	283	359	510	649	XMLBWT-00-0000-000LT50Z7	XMLBWT-00-0000-000HT50Z7	
		T4	240	261	331	471	599			
		T3	220	239	303	432	549			
		T2	200	218	276	392	499			
		S6	182	198	251	357	454			XMLBWT-00-0000-000US60Z7
		S5	172	187	237	337	429			XMLBWT-00-0000-000US50Z7
		S4	164	179	226	322	409			XMLBWT-00-0000-000US40Z7

Notes

- For additional order codes NOT recommended for new designs please see the Appendix section starting on page 31.
- Cree LED maintains a tolerance of ±7% on flux and power measurements, ±0.005 on chromaticity (CCx, CCy) measurements and a tolerance of ±2 on CRI measurements. See the Measurements section (page 25).
- XLamp XM-L2 LED order codes specify only a minimum flux bin and not a maximum. Cree LED may ship reels in flux bins higher than the minimum specified by the order code without advance notice. Shipments will always adhere to the chromaticity bin restrictions specified by the order code.

* Flux values @ 25 °C are calculated and for reference only.

** Calculated flux values are for reference only.

ORDER CODES SUGGESTED FOR NEW DESIGNS (T_J = 85 °C) - CONTINUED

Chromaticity		Minimum Luminous Flux (lm) @ 700 mA*			Calculated Minimum Luminous Flux (lm) @ 85 °C**			Order Codes		
Kit	CCT	Code	Flux (lm) @ 85 °C	Flux (lm) @ 25 °C*	1000 mA	1500 mA	2000 mA	80 CRI Typical	80 CRI Minimum	90 CRI Minimum
ANSI Warm White (2700 K - 3750 K)										
F8	2850 K	T6	280	305	386	549	699	XMLBWT-00-0000-000LT60F8	XMLBWT-00-0000-000HT60F8	
		T5	260	283	359	510	649	XMLBWT-00-0000-000LT50F8	XMLBWT-00-0000-000HT50F8	
		T4	240	261	331	471	599	XMLBWT-00-0000-000LT40F8	XMLBWT-00-0000-000HT40F8	
		T3	220	239	303	432	549			
		T2	200	218	276	392	499			
		S6	182	198	251	357	454			XMLBWT-00-0000-000US60F8
		S5	172	187	237	337	429			XMLBWT-00-0000-000US50F8
		S4	164	179	226	322	409			XMLBWT-00-0000-000US40F8
		S3	156	170	215	306	389			XMLBWT-00-0000-000US30F8
E8	2700 K	T6	280	305	386	549	699	XMLBWT-00-0000-000LT60E8	XMLBWT-00-0000-000HT60E8	
		T5	260	283	359	510	649	XMLBWT-00-0000-000LT50E8	XMLBWT-00-0000-000HT50E8	
		T4	240	261	331	471	599	XMLBWT-00-0000-000LT40E8	XMLBWT-00-0000-000HT40E8	
		T3	220	239	303	432	549			
		T2	200	218	276	392	499			
		S6	182	198	251	357	454			XMLBWT-00-0000-000US60E8
		S5	172	187	237	337	429			XMLBWT-00-0000-000US50E8
		S4	164	179	226	322	409			XMLBWT-00-0000-000US40E8
		S3	156	170	215	306	389			XMLBWT-00-0000-000US30E8

Notes

- For additional order codes NOT recommended for new designs please see the Appendix section starting on page 31.
- Cree LED maintains a tolerance of ±7% on flux and power measurements, ±0.005 on chromaticity (CCx, CCy) measurements and a tolerance of ±2 on CRI measurements. See the Measurements section (page 25).
- XLamp XM-L2 LED order codes specify only a minimum flux bin and not a maximum. Cree LED may ship reels in flux bins higher than the minimum specified by the order code without advance notice. Shipments will always adhere to the chromaticity bin restrictions specified by the order code.

* Flux values @ 25 °C are calculated and for reference only.

** Calculated flux values are for reference only.

ORDER CODES SUGGESTED FOR NEW DESIGNS (T_J = 85 °C) - CONTINUED

Chromaticity		Minimum Luminous Flux (lm) @ 700 mA*			Calculated Minimum Luminous Flux (lm) @ 85 °C**			Order Codes		
Kit	CCT	Code	Flux (lm) @ 85 °C	Flux (lm) @ 25 °C*	1000 mA	1500 mA	2000 mA	80 CRI Typical	80 CRI Minimum	90 CRI Minimum
ANSI Warm White (2700 K - 3750 K)										
Z8	2700 K	T6	280	305	386	549	699	XMLBWT-00-0000-000LT60Z8	XMLBWT-00-0000-000HT60Z8	
		T5	260	283	359	510	649	XMLBWT-00-0000-000LT50Z8	XMLBWT-00-0000-000HT50Z8	
		T4	240	261	331	471	599	XMLBWT-00-0000-000LT40Z8	XMLBWT-00-0000-000HT40Z8	
		T3	220	239	303	432	549			
		T2	200	218	276	392	499			
		S6	182	198	251	357	454			
		S5	172	187	237	337	429			XMLBWT-00-0000-000US50Z8
		S4	164	179	226	322	409			XMLBWT-00-0000-000US40Z8
S3	156	170	215	306	389			XMLBWT-00-0000-000US30Z8		

RELATIVE SPECTRAL POWER DISTRIBUTION

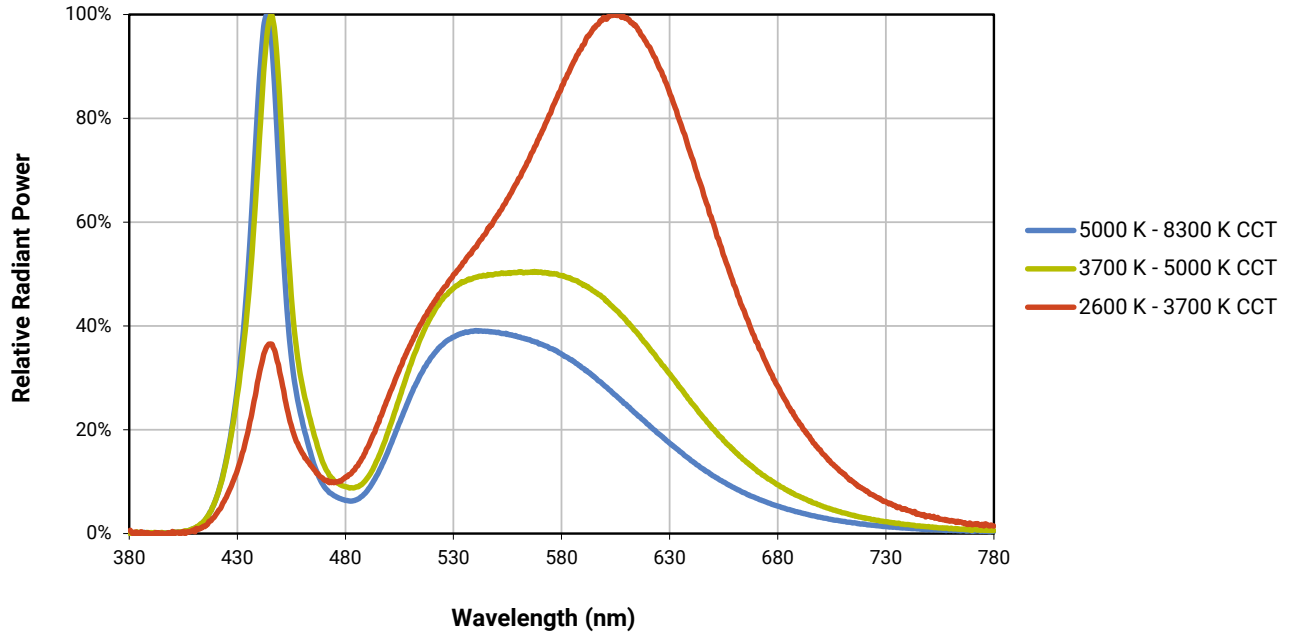

RELATIVE FLUX VS. JUNCTION TEMPERATURE ($I_f = 700 \text{ MA}$)

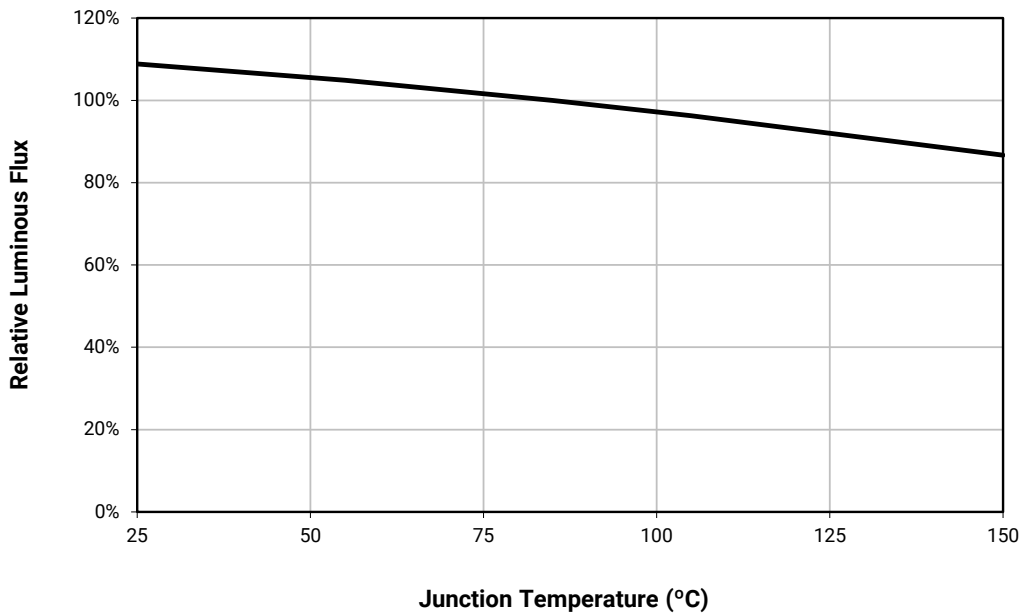

ELECTRICAL CHARACTERISTICS (T_j = 85 °C)

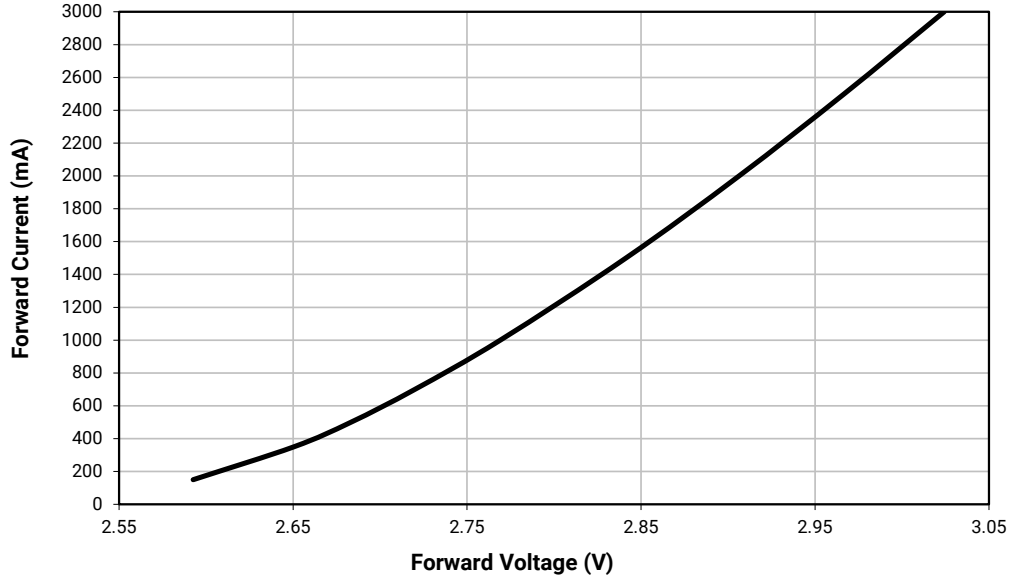

RELATIVE FLUX VS. CURRENT (T_j = 85 °C)

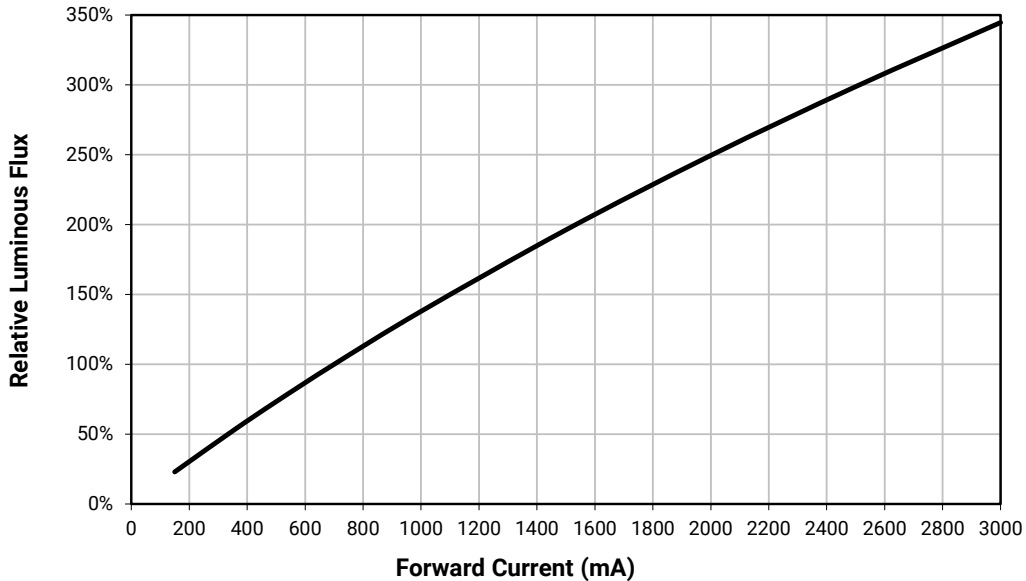

RELATIVE CHROMATICITY VS. CURRENT (WARM WHITE)

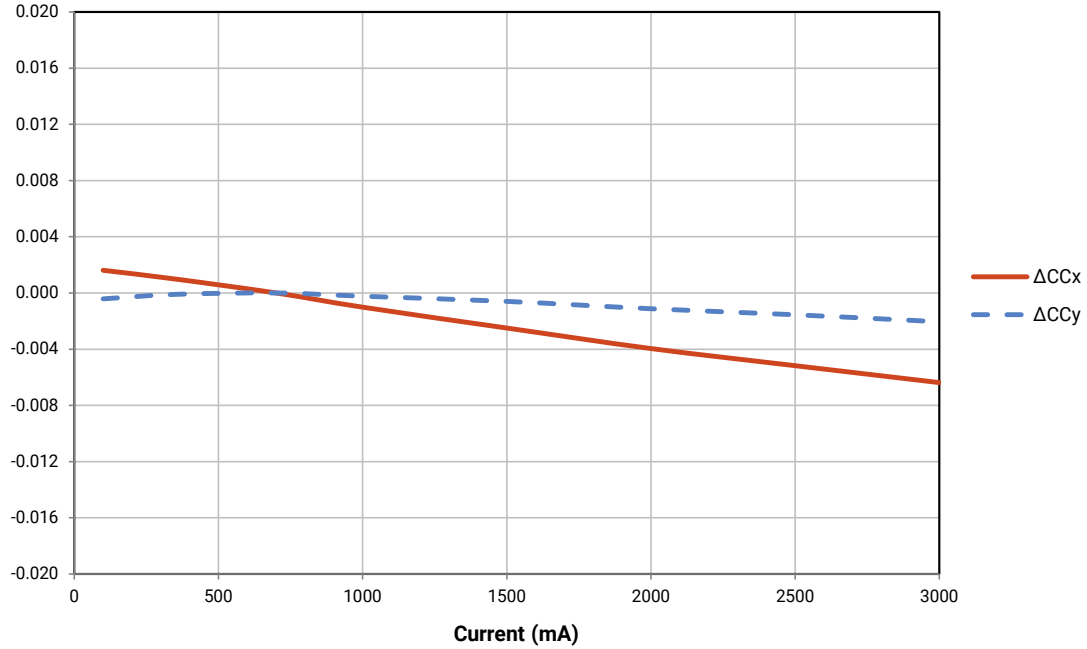

RELATIVE CHROMATICITY VS. TEMPERATURE (WARM WHITE)

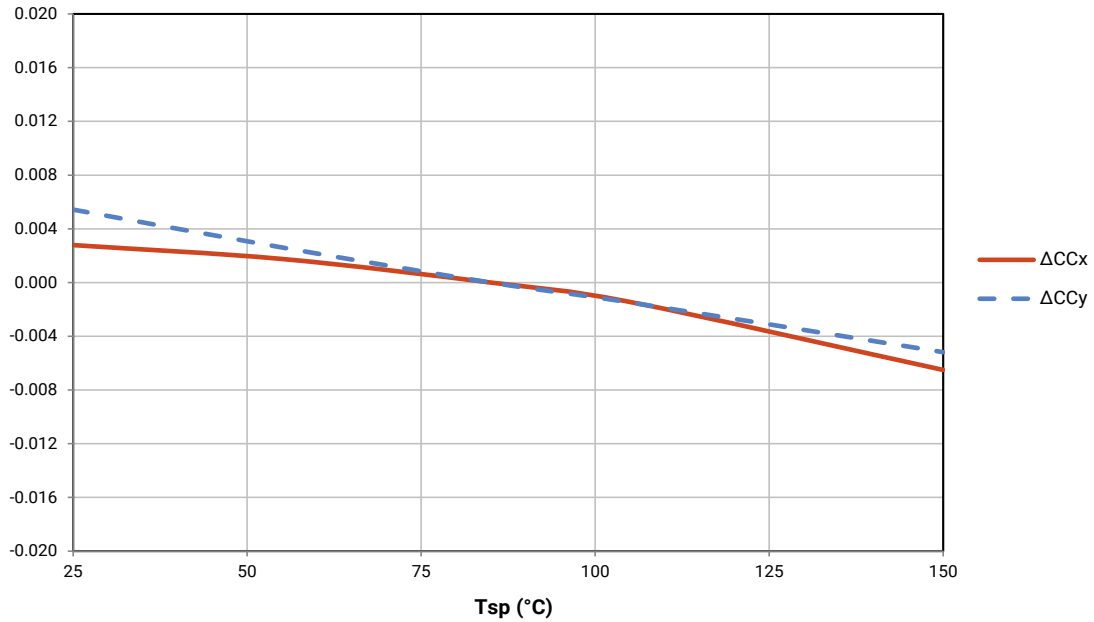

TYPICAL SPATIAL DISTRIBUTION

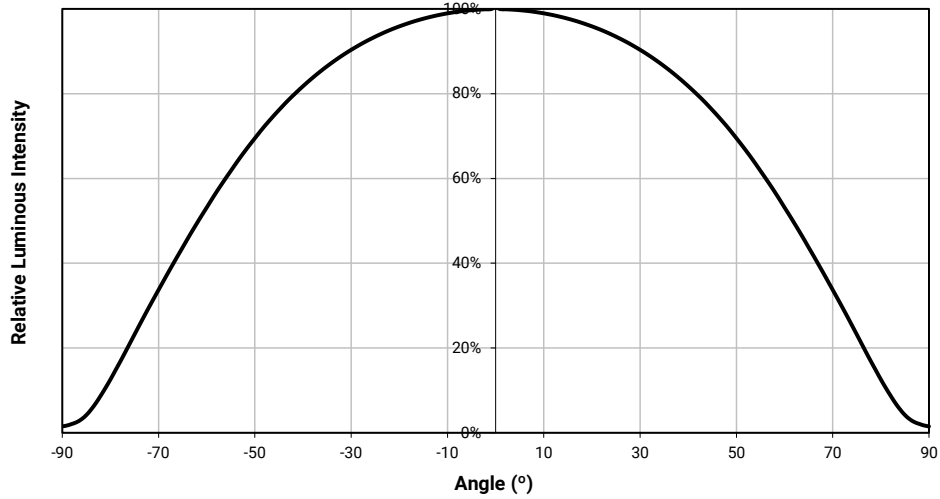

THERMAL DESIGN

The maximum forward current is determined by the thermal resistance between the LED junction and ambient. It is crucial for the end product to be designed in a manner that minimizes the thermal resistance from the solder point to ambient in order to optimize lamp life and optical characteristics.

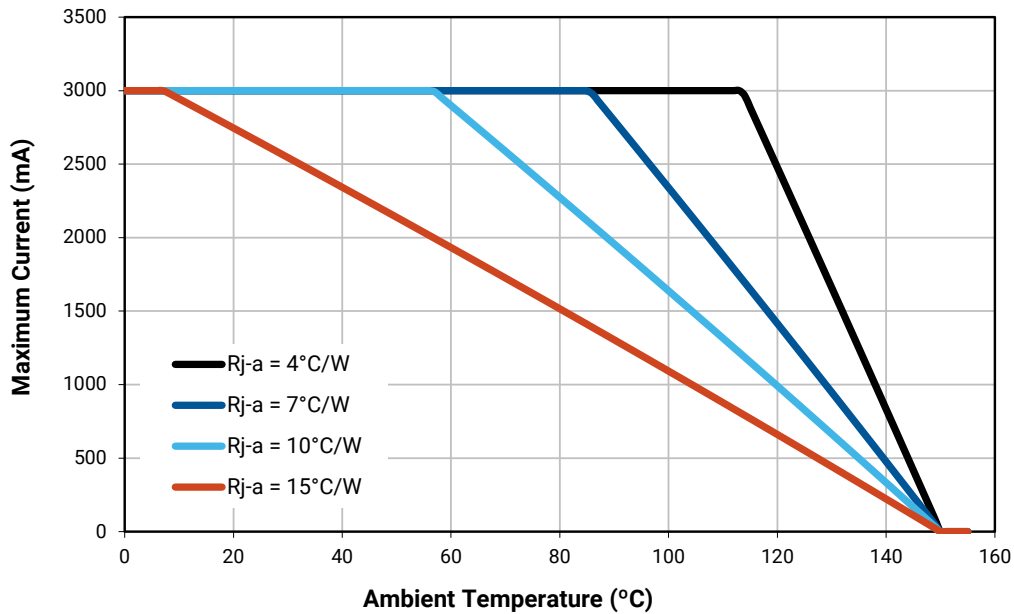

PERFORMANCE GROUPS – LUMINOUS FLUX

XLamp XM-L2 LEDs are tested for luminous flux and placed into one of the following luminous-flux groups:

Group Code	Minimum Luminous Flux @ 700 mA (lm)	Maximum Luminous Flux @ 700 mA (lm)
S3	156	164
S4	164	172
S5	172	182
S6	182	200
T2	200	220
T3	220	240
T4	240	260
T5	260	280
T6	280	300
U2	300	320
U3	320	340
U4	340	360
U5	360	380

PERFORMANCE GROUPS – CHROMATICITY

Region	x	y	Region	x	y	Region	x	y	Region	x	y
0A	0.2950	0.2970	0B	0.2920	0.3060	0C	0.2984	0.3133	0D	0.2984	0.3133
	0.2920	0.3060		0.2895	0.3135		0.2962	0.3220		0.3048	0.3207
	0.2984	0.3133		0.2962	0.3220		0.3028	0.3304		0.3068	0.3113
	0.3009	0.3042		0.2984	0.3133		0.3048	0.3207		0.3009	0.3042
0R	0.2980	0.2880	0S	0.2895	0.3135	0T	0.2962	0.3220	0U	0.3037	0.2937
	0.2950	0.2970		0.2870	0.3210		0.2937	0.3312		0.3009	0.3042
	0.3009	0.3042		0.2937	0.3312		0.3005	0.3415		0.3068	0.3113
	0.3037	0.2937		0.2962	0.3220		0.3028	0.3304		0.3093	0.2993
1A	0.3048	0.3207	1B	0.3028	0.3304	1C	0.3115	0.3391	1D	0.3130	0.3290
	0.3130	0.3290		0.3115	0.3391		0.3205	0.3481		0.3213	0.3373
	0.3144	0.3186		0.3130	0.3290		0.3213	0.3373		0.3221	0.3261
	0.3068	0.3113		0.3048	0.3207		0.3130	0.3290		0.3144	0.3186
1R	0.3068	0.3113	1S	0.3005	0.3415	1T	0.3099	0.3509	1U	0.3144	0.3186
	0.3144	0.3186		0.3099	0.3509		0.3196	0.3602		0.3221	0.3261
	0.3161	0.3059		0.3115	0.3391		0.3205	0.3481		0.3231	0.3120
	0.3093	0.2993		0.3028	0.3304		0.3115	0.3391		0.3161	0.3059

PERFORMANCE GROUPS – CHROMATICITY (CONTINUED)

Region	x	y	Region	x	y	Region	x	y	Region	x	y
2A	0.3215	0.3350	2B	0.3207	0.3462	2C	0.3290	0.3538	2D	0.3290	0.3417
	0.3290	0.3417		0.3290	0.3538		0.3376	0.3616		0.3371	0.3490
	0.3290	0.3300		0.3290	0.3417		0.3371	0.3490		0.3366	0.3369
	0.3222	0.3243		0.3215	0.3350		0.3290	0.3417		0.3290	0.3300
2R	0.3222	0.3243	2S	0.3196	0.3602	2T	0.3290	0.3690	2U	0.3290	0.3300
	0.3290	0.3300		0.3290	0.3690		0.3381	0.3762		0.3366	0.3369
	0.3290	0.3180		0.3290	0.3538		0.3376	0.3616		0.3361	0.3245
	0.3231	0.3120		0.3207	0.3462		0.3290	0.3538		0.3290	0.3180
3A	0.3371	0.3490	3B	0.3376	0.3616	3C	0.3463	0.3687	3D	0.3451	0.3554
	0.3451	0.3554		0.3463	0.3687		0.3551	0.3760		0.3533	0.3620
	0.3440	0.3427		0.3451	0.3554		0.3533	0.3620		0.3515	0.3487
	0.3366	0.3369		0.3371	0.3490		0.3451	0.3554		0.3440	0.3427
3R	0.3366	0.3369	3S	0.3381	0.3762	3T	0.3480	0.3840	3U	0.3440	0.3428
	0.3440	0.3428		0.3480	0.3840		0.3571	0.3907		0.3515	0.3487
	0.3429	0.3307		0.3463	0.3687		0.3551	0.3760		0.3495	0.3339
	0.3361	0.3245		0.3376	0.3616		0.3463	0.3687		0.3429	0.3307
4A	0.3530	0.3597	4B	0.3548	0.3736	4C	0.3641	0.3804	4D	0.3615	0.3659
	0.3615	0.3659		0.3641	0.3804		0.3736	0.3874		0.3702	0.3722
	0.3590	0.3521		0.3615	0.3659		0.3702	0.3722		0.3670	0.3578
	0.3512	0.3465		0.3530	0.3597		0.3615	0.3659		0.3590	0.3521
4R	0.3512	0.3465	4S	0.3571	0.3907	4T	0.3668	0.3957	4U	0.3590	0.3521
	0.3590	0.3521		0.3668	0.3957		0.3771	0.4034		0.3670	0.3578
	0.3567	0.3389		0.3641	0.3804		0.3736	0.3874		0.3640	0.3440
	0.3495	0.3339		0.3548	0.3736		0.3641	0.3804		0.3567	0.3389
5A1	0.3670	0.3578	5A2	0.3686	0.3649	5A3	0.3744	0.3685	5A4	0.3726	0.3612
	0.3686	0.3649		0.3702	0.3722		0.3763	0.3760		0.3744	0.3685
	0.3744	0.3685		0.3763	0.3760		0.3825	0.3798		0.3804	0.3721
	0.3726	0.3612		0.3744	0.3685		0.3804	0.3721		0.3783	0.3646
5B1	0.3702	0.3722	5B2	0.3719	0.3797	5B3	0.3782	0.3837	5B4	0.3763	0.3760
	0.3719	0.3797		0.3736	0.3874		0.3802	0.3916		0.3782	0.3837
	0.3782	0.3837		0.3802	0.3916		0.3869	0.3958		0.3847	0.3877
	0.3763	0.3760		0.3782	0.3837		0.3847	0.3877		0.3825	0.3798
5C1	0.3825	0.3798	5C2	0.3847	0.3877	5C3	0.3912	0.3917	5C4	0.3887	0.3836
	0.3847	0.3877		0.3869	0.3958		0.3937	0.4001		0.3912	0.3917
	0.3912	0.3917		0.3937	0.4001		0.4006	0.4044		0.3978	0.3958
	0.3887	0.3836		0.3912	0.3917		0.3978	0.3958		0.3950	0.3875
5D1	0.3783	0.3646	5D2	0.3804	0.3721	5D3	0.3863	0.3758	5D4	0.3840	0.3681
	0.3804	0.3721		0.3825	0.3798		0.3887	0.3836		0.3863	0.3758
	0.3863	0.3758		0.3887	0.3836		0.3950	0.3875		0.3924	0.3794
	0.3840	0.3681		0.3863	0.3758		0.3924	0.3794		0.3898	0.3716

PERFORMANCE GROUPS – CHROMATICITY (CONTINUED)

Region	x	y	Region	x	y	Region	x	y	Region	x	y
6A1	0.3889	0.3690	6A2	0.3915	0.3768	6A3	0.3981	0.3800	6A4	0.3953	0.3720
	0.3915	0.3768		0.3941	0.3848		0.4010	0.3882		0.3981	0.3800
	0.3981	0.3800		0.4010	0.3882		0.4080	0.3916		0.4048	0.3832
	0.3953	0.3720		0.3981	0.3800		0.4048	0.3832		0.4017	0.3751
6B1	0.3941	0.3848	6B2	0.3968	0.3930	6B3	0.4040	0.3966	6B4	0.4010	0.3882
	0.3968	0.3930		0.3996	0.4015		0.4071	0.4052		0.4040	0.3966
	0.4040	0.3966		0.4071	0.4052		0.4146	0.4089		0.4113	0.4001
	0.4010	0.3882		0.4040	0.3966		0.4113	0.4001		0.4080	0.3916
6C1	0.4080	0.3916	6C2	0.4113	0.4001	6C3	0.4186	0.4037	6C4	0.4150	0.3950
	0.4113	0.4001		0.4146	0.4089		0.4222	0.4127		0.4186	0.4037
	0.4186	0.4037		0.4222	0.4127		0.4299	0.4165		0.4259	0.4073
	0.4150	0.3950		0.4186	0.4037		0.4259	0.4073		0.4221	0.3984
6D1	0.4017	0.3751	6D2	0.4048	0.3832	6D3	0.4116	0.3865	6D4	0.4082	0.3782
	0.4048	0.3832		0.4080	0.3916		0.4150	0.3950		0.4116	0.3865
	0.4116	0.3865		0.4150	0.3950		0.4221	0.3984		0.4183	0.3898
	0.4082	0.3782		0.4116	0.3865		0.4183	0.3898		0.4147	0.3814
7A1	0.4147	0.3814	7A2	0.4183	0.3898	7A3	0.4242	0.3919	7A4	0.4203	0.3833
	0.4183	0.3898		0.4221	0.3984		0.4281	0.4006		0.4242	0.3919
	0.4242	0.3919		0.4281	0.4006		0.4342	0.4028		0.4300	0.3939
	0.4203	0.3833		0.4242	0.3919		0.4300	0.3939		0.4259	0.353
7B1	0.4221	0.3984	7B2	0.4259	0.4073	7B3	0.4322	0.4096	7B4	0.4281	0.4006
	0.4259	0.4073		0.4299	0.4165		0.4364	0.4188		0.4322	0.4096
	0.4322	0.4096		0.4364	0.4188		0.4430	0.4212		0.4385	0.4119
	0.4281	0.4006		0.4322	0.4096		0.4385	0.4119		0.4342	0.4028
7C1	0.4342	0.4028	7C2	0.4385	0.4119	7C3	0.4449	0.4141	7C4	0.4403	0.4049
	0.4385	0.4119		0.4430	0.4212		0.4496	0.4236		0.4449	0.4141
	0.4449	0.4141		0.4496	0.4236		0.4562	0.4260		0.4513	0.4164
	0.4403	0.4049		0.4449	0.4141		0.4513	0.4164		0.4465	0.4071
7D1	0.4259	0.3853	7D2	0.4300	0.3939	7D3	0.4359	0.3960	7D4	0.4316	0.3873
	0.4300	0.3939		0.4342	0.4028		0.4403	0.4049		0.4359	0.3960
	0.4359	0.3960		0.4403	0.4049		0.4465	0.4071		0.4418	0.3981
	0.4316	0.3873		0.4359	0.3960		0.4418	0.3981		0.4373	0.3893
8A1	0.4373	0.3893	8A2	0.4418	0.3981	8A3	0.4475	0.3994	8A4	0.4428	0.3906
	0.4418	0.3981		0.4465	0.4071		0.4523	0.4085		0.4475	0.3994
	0.4475	0.3994		0.4523	0.4085		0.4582	0.4099		0.4532	0.4008
	0.4428	0.3906		0.4475	0.3994		0.4532	0.4008		0.4483	0.3919
8B1	0.4465	0.4071	8B2	0.4513	0.4164	8B3	0.4573	0.4178	8B4	0.4523	0.4085
	0.4513	0.4164		0.4562	0.4260		0.4624	0.4274		0.4573	0.4178
	0.4573	0.4178		0.4624	0.4274		0.4687	0.4289		0.4634	0.4193
	0.4523	0.4085		0.4573	0.4178		0.4634	0.4193		0.4582	0.4099

PERFORMANCE GROUPS – CHROMATICITY (CONTINUED)

Region	x	y	Region	x	y	Region	x	y	Region	x	y
8C1	0.4582	0.4099	8C2	0.4634	0.4193	8C3	0.4695	0.4207	8C4	0.4641	0.4112
	0.4634	0.4193		0.4687	0.4289		0.4750	0.4304		0.4695	0.4207
	0.4695	0.4207		0.4750	0.4304		0.4813	0.4319		0.4756	0.4221
	0.4641	0.4112		0.4695	0.4207		0.4756	0.4221		0.4700	0.4126
8D1	0.4483	0.3919	8D2	0.4532	0.4008	8D3	0.4589	0.4021	8D4	0.4538	0.3931
	0.4532	0.4008		0.4582	0.4099		0.4641	0.4112		0.4589	0.4021
	0.4589	0.4021		0.4641	0.4112		0.4700	0.4126		0.4646	0.4034
	0.4538	0.3931		0.4589	0.4021		0.4646	0.4034		0.4593	0.3944

STANDARD COOL WHITE KITS PLOTTED ON ANSI STANDARD CHROMATICITY REGIONS

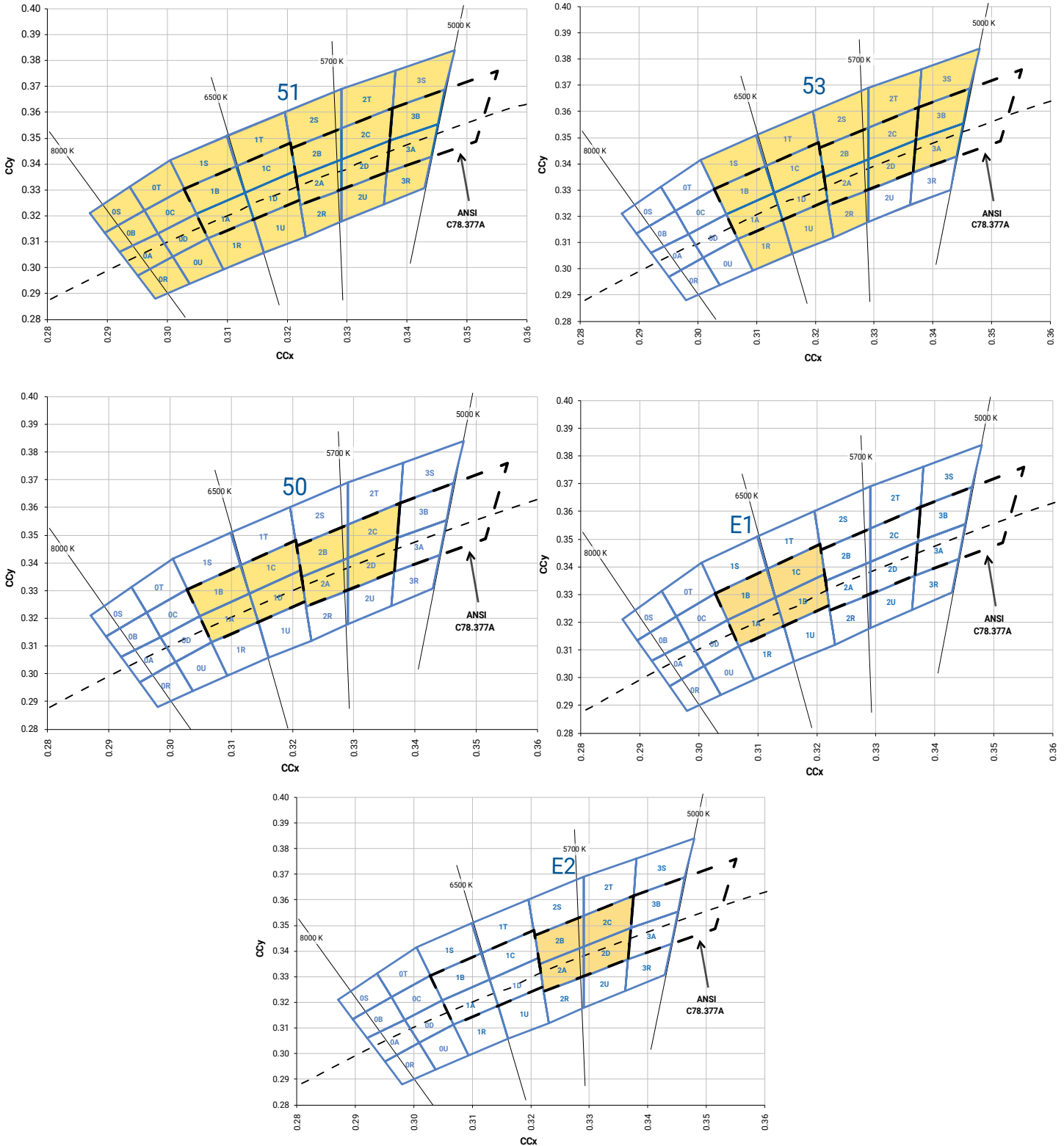

STANDARD WARM AND NEUTRAL WHITE KITS PLOTTED ON ANSI STANDARD CHROMATICITY REGIONS

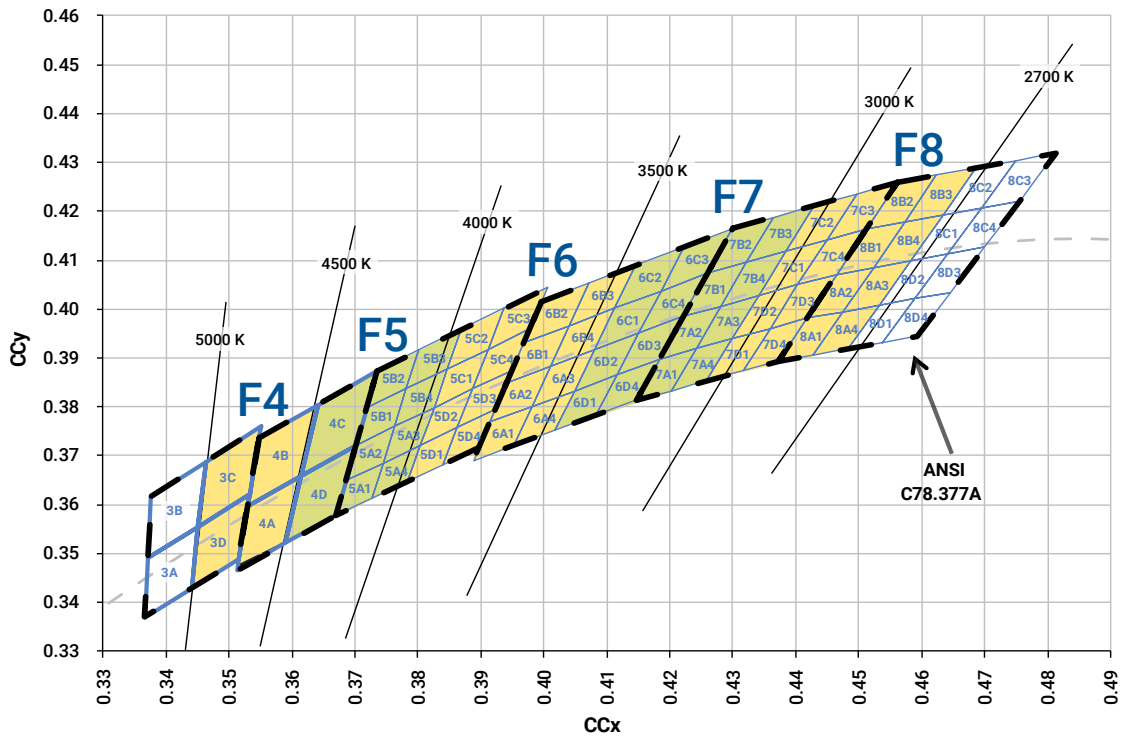
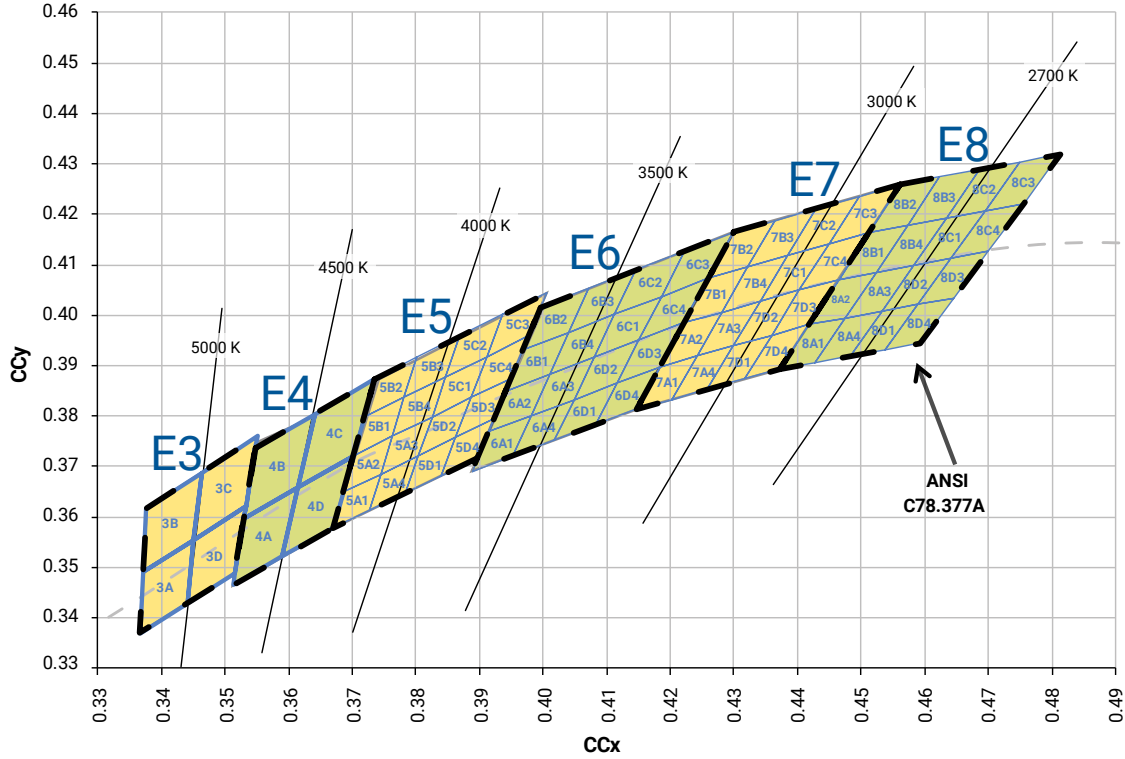

STANDARD WARM AND NEUTRAL WHITE KITS PLOTTED ON ANSI STANDARD CHROMATICITY REGIONS - CONTINUED

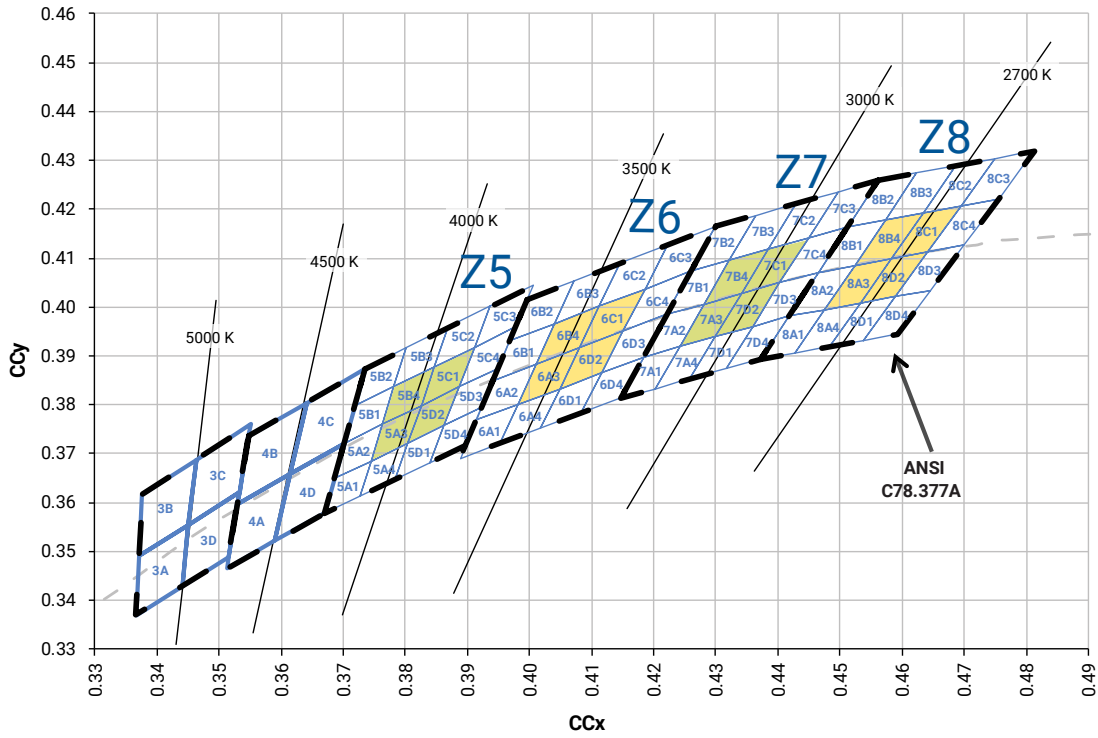

STANDARD CHROMATICITY KITS

The following table provides the chromaticity bins associated with chromaticity kits.

Color	CCT	Kit	Chromaticity Bins
Cool White	6200 K	51	0A, 0B, 0C, 0D, 0R, 0S, 0T, 0U, 1A, 1B, 1C, 1D, 1R, 1S, 1T, 1U, 2A, 2B, 2C, 2D, 2R, 2S, 2T, 2U, 3A, 3B, 3R, 3S
	6000 K	53	1A, 1B, 1C, 1D, 1R, 1S, 1T, 1U, 2A, 2B, 2C, 2D, 2R, 2S, 2T, 3A, 3B, 3S
	6200 K	50	1A, 1B, 1C, 1D, 2A, 2B, 2C, 2D
	6500 K	E1	1A, 1B, 1C, 1D
	5700 K	E2	2A, 2B, 2C, 2D
Neutral White	5000 K	E3	3A, 3B, 3C, 3D
	4750 K	F4	3C, 3D, 4A, 4B
	4500 K	E4	4A, 4B, 4C, 4D
	4250 K	F5	4C, 4D, 5A1, 5A2, 5A3, 5A4, 5B1, 5B2, 5B3, 5B4
	4000 K	E5	5A1, 5A2, 5A3, 5A4, 5B1, 5B2, 5B3, 5B4, 5C1, 5C2, 5C3, 5C4, 5D1, 5D2, 5D3, 5D4
	4000 K	Z5	5A3, 5B4, 5C1, 5D2
Warm White	3750 K	F6	5C1, 5C2, 5C3, 5C4, 5D1, 5D2, 5D3, 5D4, 6A1, 6A2, 6A3, 6A4, 6B1, 6B2, 6B3, 6B4
	3500 K	E6	6A1, 6A2, 6A3, 6A4, 6B1, 6B2, 6B3, 6B4, 6C1, 6C2, 6C3, 6C4, 6D1, 6D2, 6D3, 6D4
	3500 K	Z6	6A3, 6B4, 6C1, 6D2
	3250 K	F7	6C1, 6C2, 6C3, 6C4, 6D1, 6D2, 6D3, 6D4, 7A1, 7A2, 7A3, 7A4, 7B1, 7B2, 7B3, 7B4
	3000 K	E7	7A1, 7A2, 7A3, 7A4, 7B1, 7B2, 7B3, 7B4, 7C1, 7C2, 7C3, 7C4, 7D1, 7D2, 7D3, 7D4
	3000 K	Z7	7A3, 7B4, 7C1, 7D2
	2850 K	F8	7C1, 7C2, 7C3, 7C4, 7D1, 7D2, 7D3, 7D4, 8A1, 8A2, 8A3, 8A4, 8B1, 8B2, 8B3, 8B4
	2700 K	E8	8A1, 8A2, 8A3, 8A4, 8B1, 8B2, 8B3, 8B4, 8C1, 8C2, 8C3, 8C4, 8D1, 8D2, 8D3, 8D4
	2700 K	Z8	8A3, 8B4, 8C1, 8D2

BIN AND ORDER CODE FORMATS

Bin codes and order codes for XM-L2 LEDs are configured in the following manner:

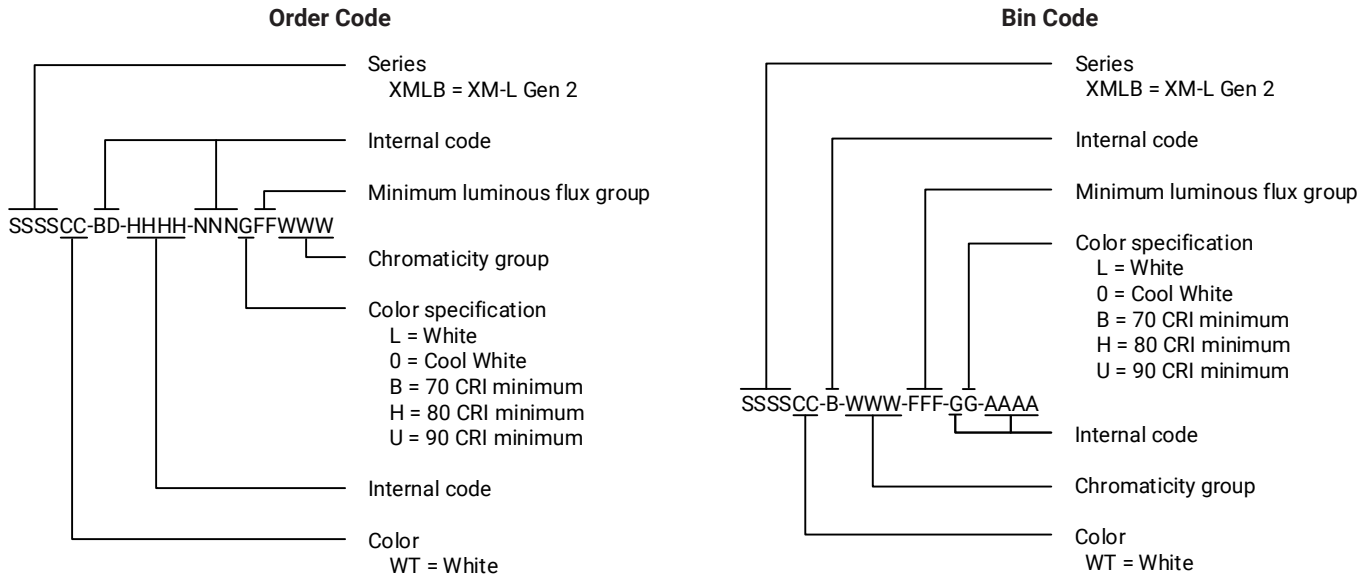

REFLOW SOLDERING CHARACTERISTICS

In testing, Cree LED has found XLamp XM-L2 LEDs to be compatible with JEDEC J-STD-020C, using the parameters listed below. As a general guideline, Cree LED recommends that users follow the recommended soldering profile provided by the manufacturer of the solder paste used, and therefore it is the lamp or luminaire manufacturer’s responsibility to determine applicable soldering requirements.

Note that this general guideline may not apply to all PCB designs and configurations of reflow soldering equipment.

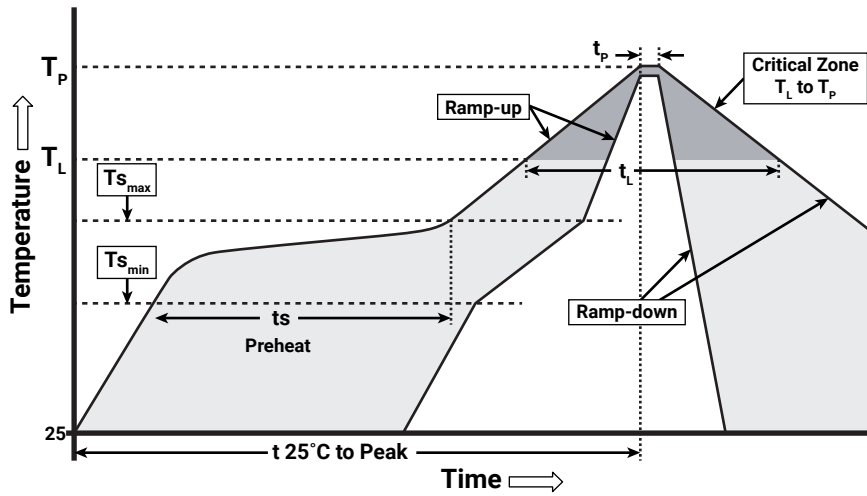

IPC/JEDEC J-STD-020C

Profile Feature	Lead-Free Solder
Average Ramp-Up Rate ($T_{s_{max}}$ to T_p)	1.2 °C/second
Preheat: Temperature Min ($T_{s_{min}}$)	120 °C
Preheat: Temperature Max ($T_{s_{max}}$)	170 °C
Preheat: Time ($t_{s_{min}}$ to $t_{s_{max}}$)	65-150 seconds
Time Maintained Above: Temperature (T_L)	217 °C
Time Maintained Above: Time (t_L)	45-90 seconds
Peak/Classification Temperature (T_p)	235 - 245 °C
Time Within 5 °C of Actual Peak Temperature (t_p)	20-40 seconds
Ramp-Down Rate	1 - 6 °C/second
Time 25 °C to Peak Temperature	4 minutes max.

Note: All temperatures refer to the topside of the package, measured on the package body surface.

NOTES

Measurements

The luminous flux, radiant power, chromaticity, forward voltage and CRI measurements in this document are binning specifications only and solely represent product measurements as of the date of shipment. These measurements will change over time based on a number of factors that are not within Cree LED's control and are not intended or provided as operational specifications for the products. Calculated values are provided for informational purposes only and are not intended or provided as specifications.

Pre-Release Qualification Testing

Please read the [LED Reliability Overview](#) for details of the qualification process Cree LED applies to ensure long-term reliability for XLamp LEDs and details of Cree LED's pre-release qualification testing for XLamp LEDs.

Lumen Maintenance

Cree LED now uses standardized IES LM-80-08 and TM-21-11 methods for collecting long-term data and extrapolating LED lumen maintenance. For information on the specific LM-80 data sets available for this LED, refer to the public [LM-80 results document](#).

Please read the [Long-Term Lumen Maintenance application note](#) for more details on Cree LED's lumen maintenance testing and forecasting. Please read the [Thermal Management application note](#) for details on how thermal design, ambient temperature, and drive current affect the LED junction temperature.

Moisture Sensitivity

Cree LED recommends keeping XLamp LEDs in the provided, resealable moisture-barrier packaging (MBP) until immediately prior to soldering. Unopened MBPs that contain XLamp LEDs do not need special storage for moisture sensitivity.

Once the MBP is opened, XLamp XM-L2 LEDs may be stored as MSL 1 per JEDEC J-STD-033, meaning they have unlimited floor life in conditions of ≤ 30 °C/85% relative humidity (RH). Regardless of the storage condition, Cree LED recommends sealing any unsoldered LEDs in the original MBP.

RoHS Compliance

The levels of RoHS restricted materials in this product are below the maximum concentration values (also referred to as the threshold limits) permitted for such substances, or are used in an exempted application, in accordance with EU Directive 2011/65/EC (RoHS2), as implemented January 2, 2013. RoHS Declarations for this product can be obtained from your Cree LED representative or from the [Product Ecology](#) section of the Cree LED website.

REACH Compliance

REACH substances of very high concern (SVHCs) information is available for this product. Since the European Chemical Agency (ECHA) has published notice of their intent to frequently revise the SVHC listing for the foreseeable future, please contact a Cree LED representative to insure you get the most up-to-date REACH SVHC Declaration. REACH banned substance information (REACH Article 67) is also available upon request.

NOTES - CONTINUED

UL® Recognized Component

This product meets the requirements to be considered a UL Recognized Component with Level 4 enclosure consideration. The LED package or a portion thereof has been investigated as a fire and electrical enclosure per ANSI/UL 8750.

Vision Advisory

WARNING: Do not look at an exposed lamp in operation. Eye injury can result. For more information about LEDs and eye safety, please refer to the [LED Eye Safety application note](#).

MECHANICAL DIMENSIONS

Thermal vias, if present, are not shown on these drawings.

All measurements are ± 0.13 mm unless otherwise indicated.

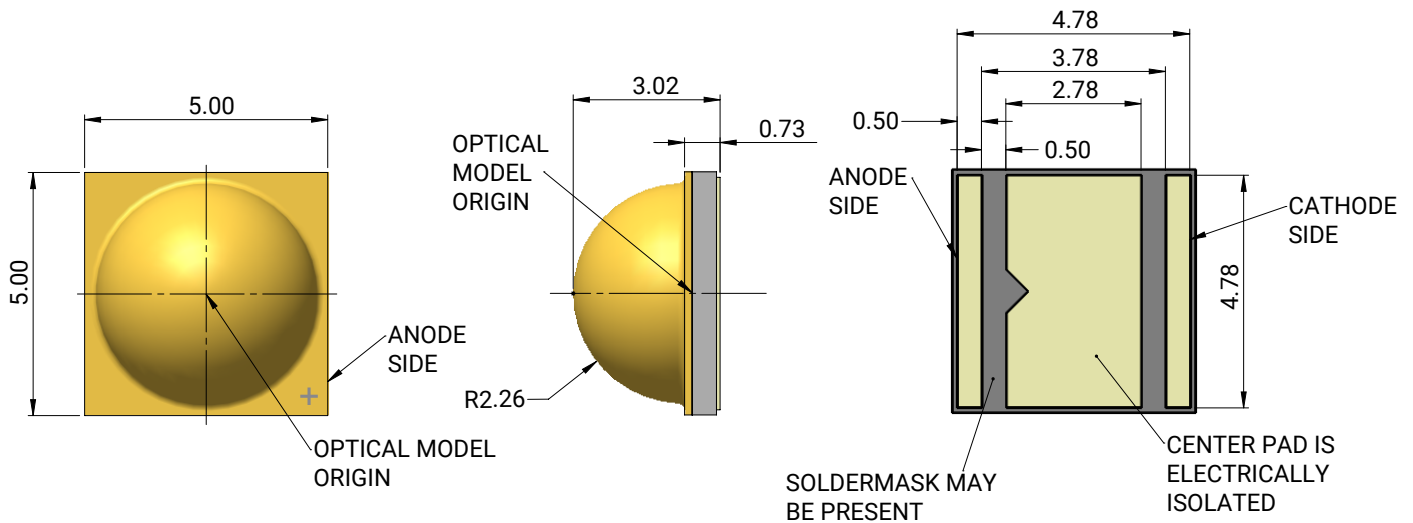

Top View

Side View

Bottom View

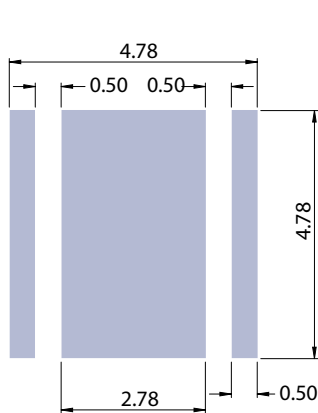

Recommended PCB Footprint

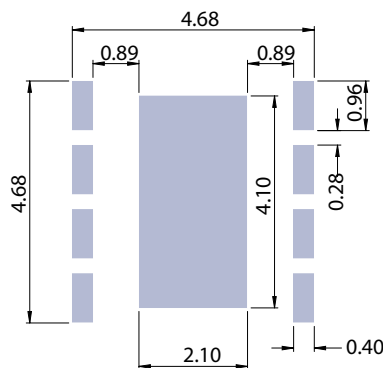

Recommended Solder Stencil*

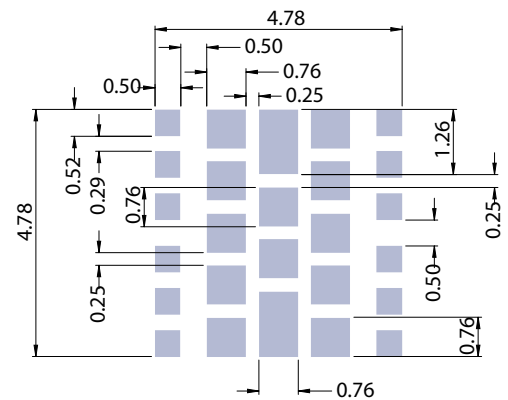

Optional Solder Stencil*

Notes:

- Cree LED recommends using thermal pad kickouts to maximize component thermal performance.
- Cree LED recommends using white solder mask material to minimize system optical loss.
- * This stencil has been tested and optimized for the avoidance of voiding when using ALPHA® LUMET® P30 Maxrel solder paste. For other solder pastes, a "window pane" design for the thermal pad stencil may result in a lower voiding percentage. Contact your local Cree LED Field Applications Engineer for consultation regarding your specific application.

TAPE AND REEL

All Cree LED carrier tapes conform to EIA-481D, Automated Component Handling Systems Standard.

Except as noted, all dimensions in mm.

All measurements are ± 0.15 mm unless otherwise indicated.

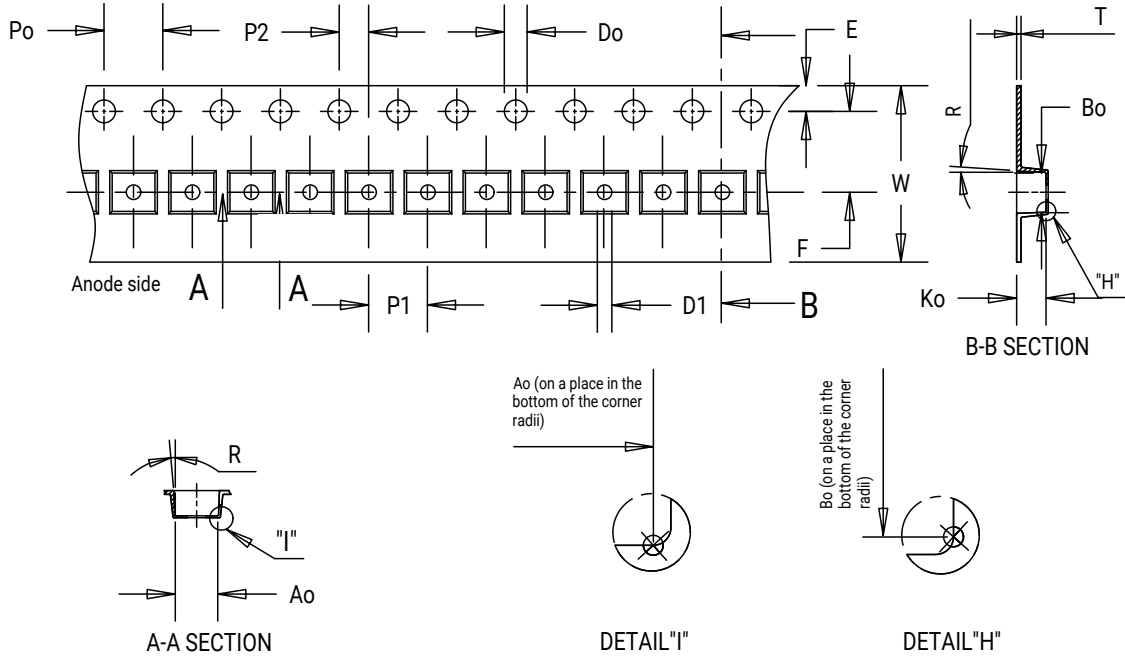

Item	Ao	Bo	Ko	Po	P1	P2	T	E	F	Do	D1	W	R
Dim.	5.40	5.40	3.35	4.00	8.00	2.00	0.36	1.75	5.50	1.50	1.50	12.00	3°

TAPE AND REEL - CONTINUED

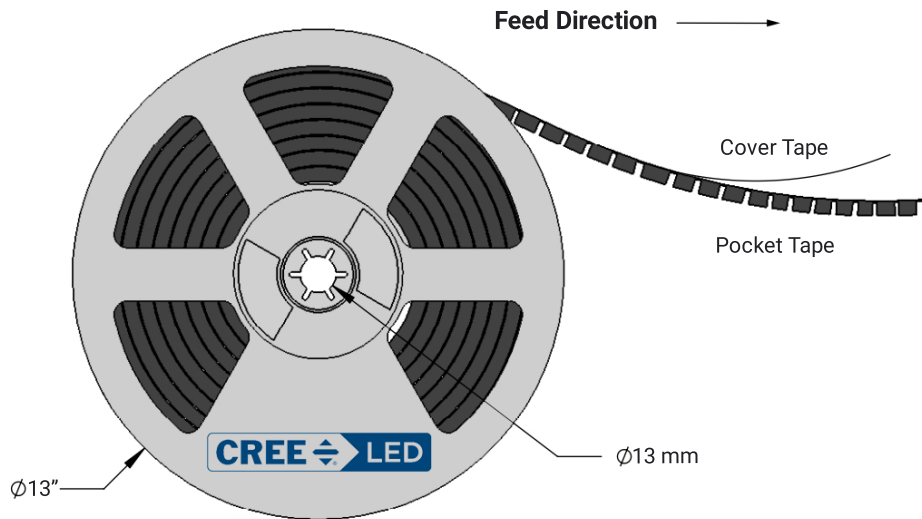
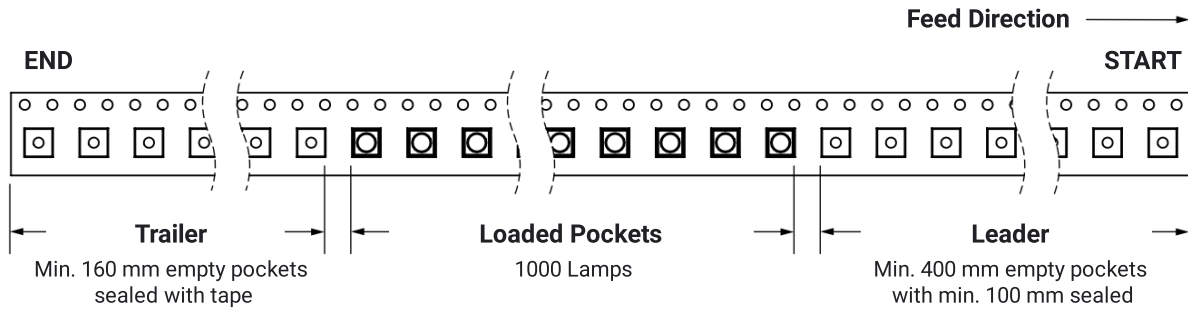

PACKAGING

Unpackaged Reel

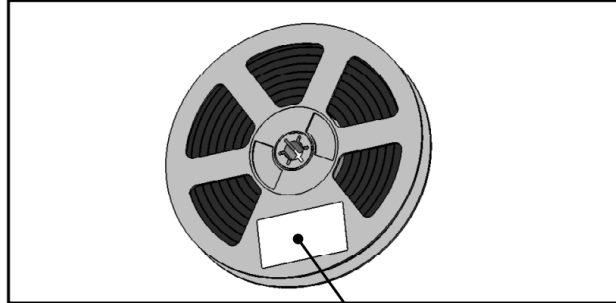

Label with Cree LED Bin Code, Quantity, Reel ID

Packaged Reel

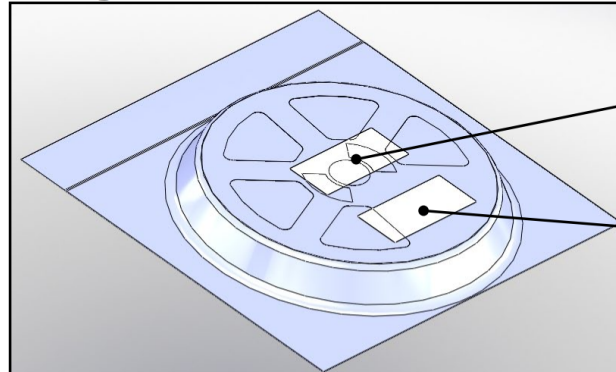

Label with Cree LED Order Code, Quantity, Reel ID, PO#

Label with Cree LED Bin Code, Quantity, Reel ID

Boxed Reel

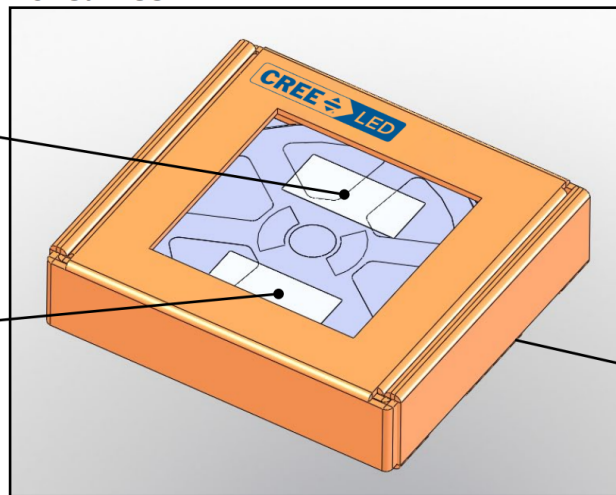

Label with Cree LED Order Code, Quantity, Reel ID, PO#

Label with Cree LED Bin Code, Quantity, Reel ID

Patent Label (on bottom of box)

APPENDIX - ORDER CODES NOT FOR NEW DESIGNS

The following order codes are active and valid order codes, but higher performance options are also available. Please see page 4 for order codes of XLamp XM-L2 LEDs that could serve as alternatives for the order codes set forth below.

Chromaticity		Minimum Luminous Flux (lm) @ 700 mA		Order Codes	
Kit	CCT	Code	Flux (lm) @ 85 °C	65 CRI Typical	85 CRI Minimum
ANSI Cool White (5000 K – 8300 K)					
51	6200 K	T5	260	XMLBWT-00-0000-0000T5051	
		T4	240		XMLBWT-00-0000-000PT4051
		T3	220		XMLBWT-00-0000-000PT3051
		T2	200		XMLBWT-00-0000-000PT2051
53	6000 K	T5	260	XMLBWT-00-0000-0000T5053	
		T4	240		XMLBWT-00-0000-000PT4053
		T3	220		XMLBWT-00-0000-000PT3053
		T2	200		XMLBWT-00-0000-000PT2053
50	6200 K	T5	260	XMLBWT-00-0000-0000T5050	
		T4	240		XMLBWT-00-0000-000PT4050
		T3	220		XMLBWT-00-0000-000PT3050
		T2	200		XMLBWT-00-0000-000PT2050
E1	6500 K	T5	260	XMLBWT-00-0000-0000T50E1	
		T4	240		XMLBWT-00-0000-000PT40E1
		T3	220		XMLBWT-00-0000-000PT30E1
		T2	200		XMLBWT-00-0000-000PT20E1
E2	5700 K	T5	260	XMLBWT-00-0000-0000T50E2	
		T4	240		XMLBWT-00-0000-000PT40E2
		T3	220		XMLBWT-00-0000-000PT30E2
		T2	200		XMLBWT-00-0000-000PT20E2

- Notes
- Cree LED maintains a tolerance of ±7% on flux and power measurements, ±0.005 on chromaticity (CCx, CCy) measurements and a tolerance of ±2 on CRI measurements. See the Measurements section (page 25).

APPENDIX - ORDER CODES NOT FOR NEW DESIGNS - CONTINUED

The following order codes are active and valid order codes, but higher performance options are also available. Please see page 5 - page 6 for order codes of XLamp XM-L2 LEDs that could serve as alternatives for the order codes set forth below.

Chromaticity		Minimum Luminous Flux (lm) @ 700 mA		Order Codes		
Kit	CCT	Code	Flux (lm) @ 85 °C	70 CRI Minimum	75 CRI Typical	80 CRI Minimum
ANSI Neutral White (3700 K – 5000 K)						
E3	5000 K	T6	280	XMLBWT-00-0000-000BT60E3	XMLBWT-00-0000-000LT60E3	
		T5	260	XMLBWT-00-0000-000BT50E3	XMLBWT-00-0000-000LT50E3	
		T4	240		XMLBWT-00-0000-000LT40E3	
F4	4750 K	T6	280	XMLBWT-00-0000-000BT60F4		
		T5	260	XMLBWT-00-0000-000BT50F4	XMLBWT-00-0000-000LT50F4	
		T4	240		XMLBWT-00-0000-000LT40F4	
E4	4500 K	T6	280	XMLBWT-00-0000-000BT60E4		
		T5	260	XMLBWT-00-0000-000BT50E4	XMLBWT-00-0000-000LT50E4	
		T4	240		XMLBWT-00-0000-000LT40E4	
F5	4250 K	T6	280	XMLBWT-00-0000-000BT60F5		
		T5	260	XMLBWT-00-0000-000BT50F5	XMLBWT-00-0000-000LT50F5	
		T4	240		XMLBWT-00-0000-000LT40F5	
E5	4000 K	T6	280	XMLBWT-00-0000-000BT60E5		
		T5	260	XMLBWT-00-0000-000BT50E5	XMLBWT-00-0000-000LT50E5	XMLBWT-00-0000-000HT50E5
		T4	240	XMLBWT-00-0000-000BT40E5	XMLBWT-00-0000-000LT40E5	XMLBWT-00-0000-000HT40E5
		T3	220		XMLBWT-00-0000-000LT30E5	XMLBWT-00-0000-000HT30E5
Z5	4000 K	T5	260		XMLBWT-00-0000-000LT50Z5	XMLBWT-00-0000-000HT50Z5
		T4	240		XMLBWT-00-0000-000LT40Z5	XMLBWT-00-0000-000HT40Z5
		T3	220		XMLBWT-00-0000-000LT30Z5	XMLBWT-00-0000-000HT30Z5

- Notes
- Cree LED maintains a tolerance of ±7% on flux and power measurements, ±0.005 on chromaticity (CCx, CCy) measurements and a tolerance of ±2 on CRI measurements. See the Measurements section (page 25).

APPENDIX - ORDER CODES NOT FOR NEW DESIGNS - CONTINUED

The following order codes are active and valid order codes, but higher performance options are also available. Please see page 7 - page 9 for order codes of XLamp XM-L2 LEDs that could serve as alternatives for the order codes set forth below.

Chromaticity		Minimum Luminous Flux (lm) @ 700 mA		Order Codes		
Kit	CCT	Code	Flux (lm) @ 85 °C	80 CRI Typical	80 CRI Minimum	85 CRI Minimum
ANSI Warm White (2700 K - 3750 K)						
F6	3750 K	T4	240	XMLBWT-00-0000-000LT40F6	XMLBWT-00-0000-000HT40F6	
		T3	220	XMLBWT-00-0000-000LT30F6	XMLBWT-00-0000-000HT30F6	
		T2	200	XMLBWT-00-0000-000LT20F6	XMLBWT-00-0000-000HT20F6	
E6	3500 K	T4	240	XMLBWT-00-0000-000LT40E6	XMLBWT-00-0000-000HT40E6	
		T3	220	XMLBWT-00-0000-000LT30E6	XMLBWT-00-0000-000HT30E6	
		T2	200	XMLBWT-00-0000-000LT20E6	XMLBWT-00-0000-000HT20E6	
Z6	3500 K	T4	240	XMLBWT-00-0000-000LT40Z6	XMLBWT-00-0000-000HT40Z6	
		T3	220	XMLBWT-00-0000-000LT30Z6	XMLBWT-00-0000-000HT30Z6	
		T2	200	XMLBWT-00-0000-000LT20Z6	XMLBWT-00-0000-000HT20Z6	
F7	3250 K	T4	240	XMLBWT-00-0000-000LT40F7	XMLBWT-00-0000-000HT40F7	
		T3	220	XMLBWT-00-0000-000LT30F7	XMLBWT-00-0000-000HT30F7	
		T2	200	XMLBWT-00-0000-000LT20F7	XMLBWT-00-0000-000HT20F7	
E7	3000 K	T4	240	XMLBWT-00-0000-000LT40E7	XMLBWT-00-0000-000HT40E7	
		T3	220	XMLBWT-00-0000-000LT30E7	XMLBWT-00-0000-000HT30E7	
		T2	200	XMLBWT-00-0000-000LT20E7	XMLBWT-00-0000-000HT20E7	XMLBWT-00-0000-000PT20E7
		S6	182			XMLBWT-00-0000-000PS60E7
		S5	172			XMLBWT-00-0000-000PS50E7
		S4	164			XMLBWT-00-0000-000PS40E7

- Notes
- Cree LED maintains a tolerance of ±7% on flux and power measurements, ±0.005 on chromaticity (CCx, CCy) measurements and a tolerance of ±2 on CRI measurements. See the Measurements section (page 25).

APPENDIX - ORDER CODES NOT FOR NEW DESIGNS - CONTINUED

Chromaticity		Minimum Luminous Flux (lm) @ 700 mA		Order Codes		
Kit	CCT	Code	Flux (lm) @ 85 °C	80 CRI Typical	80 CRI Minimum	85 CRI Minimum
ANSI Warm White (2700 K - 3750 K)						
Z7	3000 K	T4	240	XMLBWT-00-0000-000LT40Z7	XMLBWT-00-0000-000HT40Z7	
		T3	220	XMLBWT-00-0000-000LT30Z7	XMLBWT-00-0000-000HT30Z7	
		T2	200	XMLBWT-00-0000-000LT20Z7	XMLBWT-00-0000-000HT20Z7	
		S6	182			XMLBWT-00-0000-000PS60Z7
		S5	172			XMLBWT-00-0000-000PS50Z7
		S4	164			XMLBWT-00-0000-000PS40Z7
F8	2850 K	T3	220	XMLBWT-00-0000-000LT30F8	XMLBWT-00-0000-000HT30F8	
		T2	200	XMLBWT-00-0000-000LT20F8	XMLBWT-00-0000-000HT20F8	
		S6	182	XMLBWT-00-0000-000LS60F8	XMLBWT-00-0000-000HS60F8	XMLBWT-00-0000-000PS60F8
		S5	172			XMLBWT-00-0000-000PS50F8
		S4	164			XMLBWT-00-0000-000PS40F8
		S3	156			XMLBWT-00-0000-000PS30F8
E8	2700 K	T3	220	XMLBWT-00-0000-000LT30E8	XMLBWT-00-0000-000HT30E8	
		T2	200	XMLBWT-00-0000-000LT20E8	XMLBWT-00-0000-000HT20E8	
		S6	182	XMLBWT-00-0000-000LS60E8	XMLBWT-00-0000-000HS60E8	XMLBWT-00-0000-000PS60E8
		S5	172			XMLBWT-00-0000-000PS50E8
		S4	164			XMLBWT-00-0000-000PS40E8
		S3	156			XMLBWT-00-0000-000PS30E8

- Notes
- Cree LED maintains a tolerance of ±7% on flux and power measurements, ±0.005 on chromaticity (CCx, CCy) measurements and a tolerance of ±2 on CRI measurements. See the Measurements section (page 25).



APPENDIX - ORDER CODES NOT FOR NEW DESIGNS - CONTINUED

Chromaticity		Minimum Luminous Flux (lm) @ 700 mA		Order Codes		
Kit	CCT	Code	Flux (lm) @ 85 °C	80 CRI Typical	80 CRI Minimum	85 CRI Minimum
ANSI Warm White (2700 K - 3750 K)						
Z8	2700 K	T3	220	XMLBWT-00-0000-000LT30Z8	XMLBWT-00-0000-000HT30Z8	
		T2	200	XMLBWT-00-0000-000LT20Z8	XMLBWT-00-0000-000HT20Z8	
		S6	182	XMLBWT-00-0000-000LS60Z8	XMLBWT-00-0000-000HS60Z8	
		S5	172			XMLBWT-00-0000-000PS50Z8
		S4	164			XMLBWT-00-0000-000PS40Z8
		S3	156			XMLBWT-00-0000-000PS30Z8

- Notes
- Cree LED maintains a tolerance of ±7% on flux and power measurements, ±0.005 on chromaticity (CCx, CCy) measurements and a tolerance of ±2 on CRI measurements. See the Measurements section (page 25).

Looking for pricing, stock, or lifecycle information?

Click below to explore more details on WIN SOURCE:

-  [View XMLBWT-00-0000-0000U2051 on WIN SOURCE](#)
-  [CreeLED, Inc. Information](#)

Optimize Your Supply Chain with WIN SOURCE Solutions

-  Global Sourcing Solution
-  Obsolete Management
-  Cost Control Management
-  Shortage Management
-  Alternative Solution
-  Excess Inventory Management