



# THE DATASHEET OF OP165A



# Plastic Infrared Emitting Diode

OP165 Series, OP166A, OP166B

Obsolete (OP166W)



## Features:

- T-1 (3 mm) package style
- Choice of narrow or wide irradiance pattern
- Choice of dome lens or flat lens
- Mechanically and spectrally matched to other OPTEK devices
- Higher power output than GaAs at equivalent drive currents
- 935 nm diode

## Description:

Each device in the **OP165** and **OP166** series is a high intensity gallium arsenide infrared emitting diode (GaAs) that is molded in an IR transmissive clear epoxy package with either a dome or flat lens. Devices feature narrow and wide irradiance patterns and a variety of electrical characteristics. The small T-1 package style makes these devices ideal for space-limited applications.

*OP165 and OP166 devices are mechanically and spectrally matched to the OP505 and OP535 series devices.*

*Please refer to Application Bulletins 208 and 210 for additional design information and reliability (degradation) data.*

## Applications:

- Space-limited applications
- Applications requiring coupling efficiency
- Battery-operated or voltage-limited applications

Ordering Information					
Part Number	LED Peak Wavelength	Output Power (mW/cm <sup>2</sup> ) Min / Max	I <sub>F</sub> (mA) Typ / Max	Total Beam Angle	Lead Length
OP165A	935 nm	1.95 / NA	20 / 50	18°	0.50"
OP165B		1.40 / 2.20			
OP165C		0.85 / 1.60			
OP165D		0.28 / NA		90°	
OP165W		0.50 / NA			
OP166A		1.95 / NA			
OP166B		1.40 / 2.20			
OP166W (Obsolete)		0.50 / NA		90°	



RoHS

## General Note

TT Electronics reserves the right to make changes in product specification without notice or liability. All information is subject to TT Electronics' own data and is considered accurate at time of going to print.

# Plastic Infrared Emitting Diode

## OP165 Series, OP166A, OP166B

Obsolete (OP166W)



### OP165 (A, B, C, D)

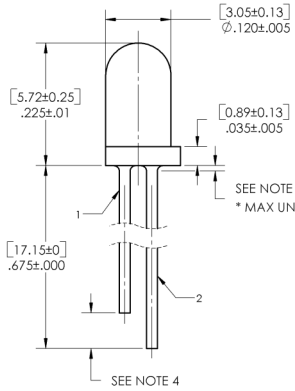

**NOTES:**

1. OUTSIDE DISCRETE SHELL IS POLYSULFONE P1700 CLEAR.
2. THIS LED IS BUILT WITH A 0.0011 X 0.011 GaAs CHIP.
3. MAX ALLOWABLE EPOXY MINISCUS IS 0.030.
4. FOR IDENTIFICATION PURPOSES, ANODE LEAD IS .065 ± .035 LONGER THAN THE CATHODE LEAD.

**DISCRETE PIN-OUT**

- 1 CATHODE
- 2 ANODE

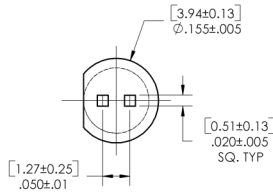

### OP165W

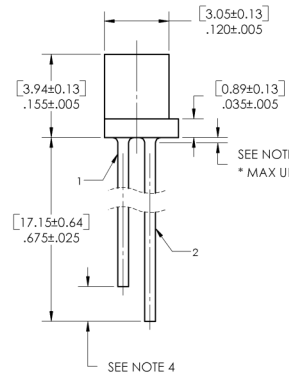

**NOTES:**

1. OUTSIDE DISCRETE SHELL IS POLYSULFONE P1700 CLEAR.
2. THIS LED IS BUILT WITH A 0.011 X 0.011 GaAs CHIP.
3. MAX ALLOWABLE EPOXY MINISCUS IS 0.030.
4. FOR IDENTIFICATION PURPOSES, ANODE LEAD IS .065 ± .035 LONGER THAN THE CATHODE LEAD.

**DISCRETE PIN-OUT**

- 1 CATHODE
- 2 ANODE

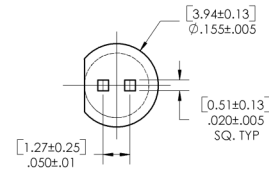

### OP166 (A, B)

DIMENSIONS ARE IN: [MILLIMETERS] [INCHES]

\* MAX UNDERFILL ALLOWED IS .015".  
\*\* ELBOW OF LEADFRAME NOT MORE THAN .005" FROM FLANGE.

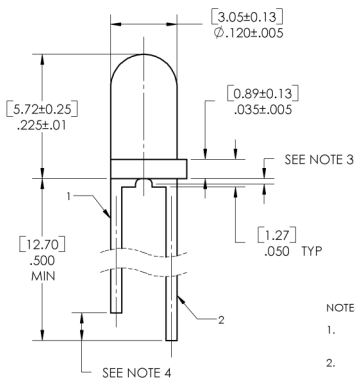

**NOTES:**

1. OUTSIDE DISCRETE SHELL IS POLYSULFONE P1700 CLEAR.
2. THIS LED IS BUILT WITH A 0.0011 X 0.011 GaAs CHIP.
3. MAX ALLOWABLE EPOXY MINISCUS IS 0.030.
4. FOR IDENTIFICATION PURPOSES, ANODE LEAD IS .050 MIN. LONGER THAN THE CATHODE LEAD.

**DISCRETE PIN-OUT**

- 1 CATHODE
- 2 ANODE

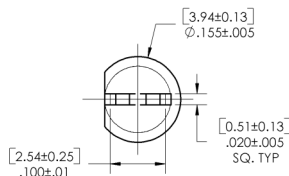

Pin #	LED
1	Cathode
2	Anode

**CONTAINS POLYSULFONE**

To avoid stress cracking, we suggest using ND Industries' **Vibra-Tite** for thread-locking. **Vibra-Tite** evaporates fast without causing structural failure in OPTEK'S molded plastics.

**General Note**

TT Electronics reserves the right to make changes in product specification without notice or liability. All information is subject to TT Electronics' own data and is considered accurate at time of going to print.

# Plastic Infrared Emitting Diode

OP165 Series, OP166A, OP166B

Obsolete (OP166W)



## Electrical Specifications

**Absolute Maximum Ratings** ( $T_A = 25^\circ\text{C}$  unless otherwise noted)

Storage and Operating Temperature Range	-40° C to +100° C
Reverse Voltage	2.0 V
Continuous Forward Current	50 mA
Peak Forward Current (1 $\mu\text{s}$ pulse width, 300 pps)	3.0 A
Lead Soldering Temperature [1/16 inch (1.6 mm) from case for 5 seconds with soldering iron]	260° C
Power Dissipation	100 mW <sup>(1)</sup>

**Electrical Characteristics** ( $T_A = 25^\circ\text{C}$  unless otherwise noted)

SYMBOL	PARAMETER	MIN	TYP	MAX	UNITS	TEST CONDITIONS
<b>Input Diode</b>						
$E_{E(APT)}$	Apertured Radiant Incidence OP165A, OP166A	1.95	-	-	mW/cm <sup>2</sup>	$I_F = 20\text{ mA}^{(2)}$
$P_O$	Radiant Power Output OP165W	0.50	-	-	mW	$I_F = 20\text{ mA}$
$V_F$	Forward Voltage	-	-	1.60	V	$I_F = 20\text{ mA}$
$I_R$	Reverse Current	-	-	100	$\mu\text{A}$	$V_R = 2\text{ V}$
$\lambda_P$	Wavelength at Peak Emission	-	935	-	nm	$I_F = 10\text{ mA}$
B	Spectral Bandwidth between Half Power Points	-	50	-	nm	$I_F = 10\text{ mA}$
$\Delta\lambda_P/\Delta T$	Spectral Shift with Temperature OP165 (A, B, C, D), OP166 (A, B) OP165W	-	-	-	nm/° C	$I_F = \text{Constant}$
$\theta_{HP}$	Emission Angle at Half Power Points OP165 (A, B, C, D), OP166 (A, B) OP165W	-	18	-	Degree	$I_F = 20\text{ mA}$
		-	90	-		
$t_r$	Output Rise Time	-	1000	-	ns	$I_{F(PK)} = 100\text{ mA}$ , PW = 10 $\mu\text{s}$ , D.C. = 10.0 %
$t_f$	Output Fall Time	-	500	-		

Notes:

- Derate linearly 1.33 mW/° C above 25° C.
- $E_{E(APT)}$  is a measurement of the average apertured radiant incidence upon a sensing area 0.081" (2.06 mm) in diameter, perpendicular to and centered on the mechanical axis of the lens, and 0.590" (14.99 mm) from the measurement surface.  $E_{E(APT)}$  is not necessarily uniform within the measured areas.

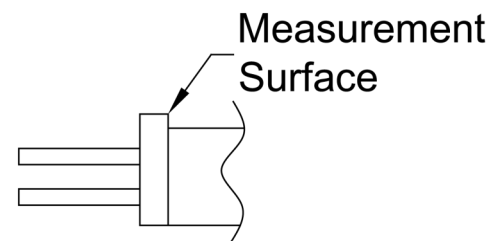

**General Note**

TT Electronics reserves the right to make changes in product specification without notice or liability. All information is subject to TT Electronics' own data and is considered accurate at time of going to print.

TT Electronics | OPTEK Technology  
2900 E. Plano Pkwy, Plano, TX 75074 | Ph: +1 972 323 2200  
www.ttelectronics.com | sensors@ttelectronics.com

# Plastic Infrared Emitting Diode

OP165 Series, OP166A, OP166B

Obsolete (OP166W)



## Performance

OP165 (A, B, C, D, W), OP166 (A, B)

Forward Voltage vs Forward Current vs Temperature

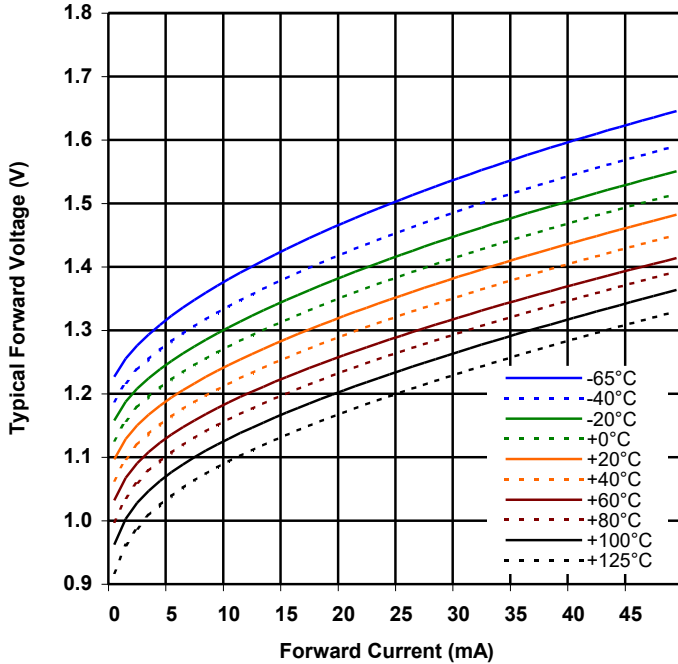

Optical Power vs  $I_F$  vs Temp

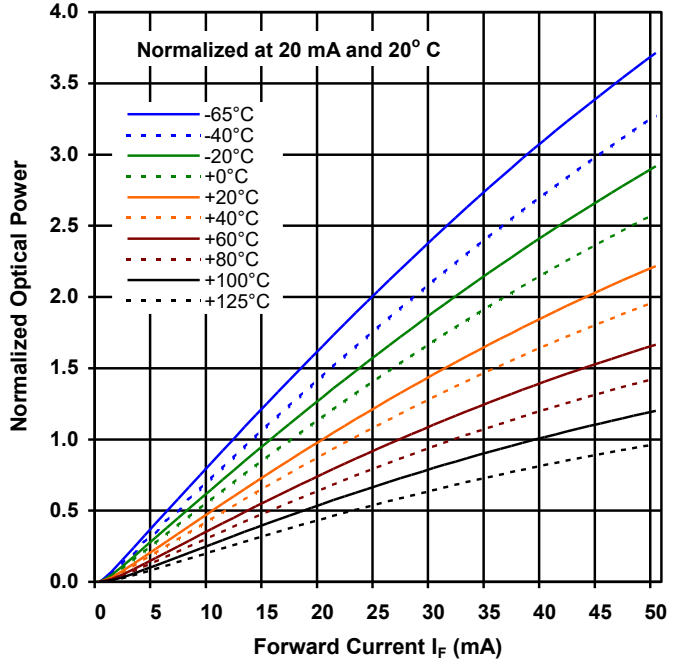

Distance vs Output Power vs Forward Current

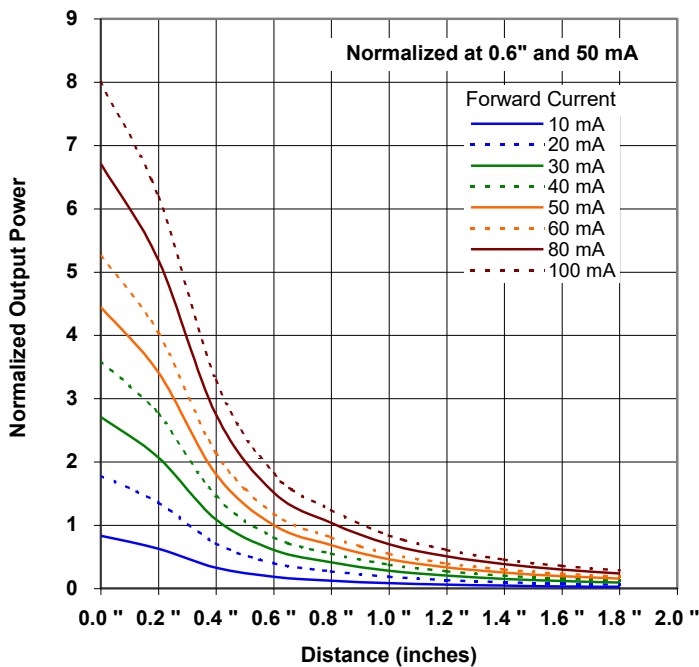

Relative Radiant Intensity vs Angular Displacement

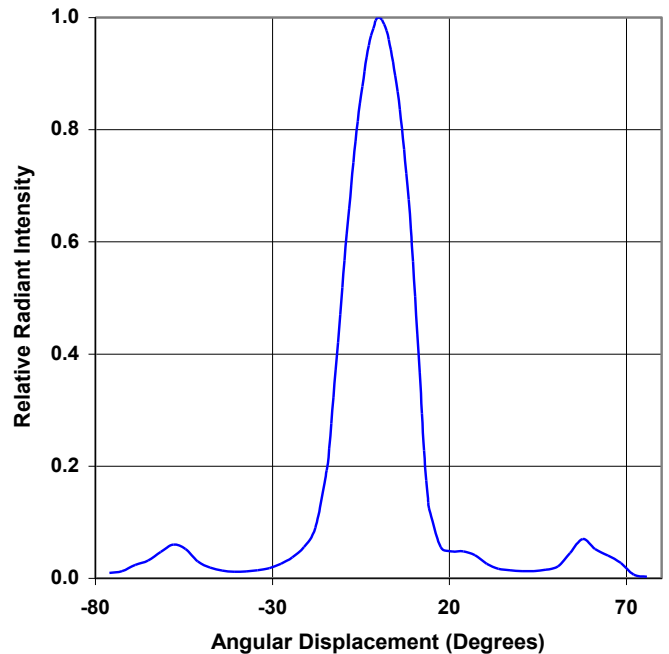

**General Note**

TT Electronics reserves the right to make changes in product specification without notice or liability. All information is subject to TT Electronics' own data and is considered accurate at time of going to print.

TT Electronics | OPTEK Technology  
2900 E. Plano Pkwy, Plano, TX 75074 | Ph: +1 972 323 2200  
www.ttelectronics.com | sensors@ttelectronics.com

## Looking for pricing, stock, or lifecycle information?

Click below to explore more details on WIN SOURCE:

 [View OP165A](#) on WIN SOURCE

 [TT Electronics](#) Information

## Optimize Your Supply Chain with WIN SOURCE Solutions

-  Global Sourcing Solution
-  Obsolete Management
-  Cost Control Management
-  Shortage Management
-  Alternative Solution
-  Excess Inventory Management