

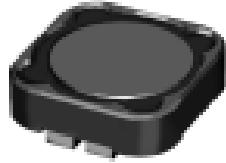

**THE DATASHEET OF  
CDRH124NP-680MC**



# SMD Power Inductor CDRH124



## Description

- Ferrite drum core construction.
- Magnetically shielded.
- L × W × H: 12.3 × 12.3 × 4.5 mm Max.
- Product weight: 2.3g(Ref.)
- Moisture Sensitivity Level: 1
- RoHS compliance.

## Environmental Data

- Operating temperature range: -40°C ~ +100°C (including coil's self temperature rise)
- Storage temperature range: -40°C ~ +100°C
- Solder reflow temperature: 260 °C peak.

## Packaging

- Carrier tape and reel packaging
- 13" diameter reel
- 500pcs per reel

## Applications

- Ideally used in Notebook PC, LCD TV, DVD, Game machine, STB, Projector etc as DC-DC converter inductors.

## Dimension - [mm]

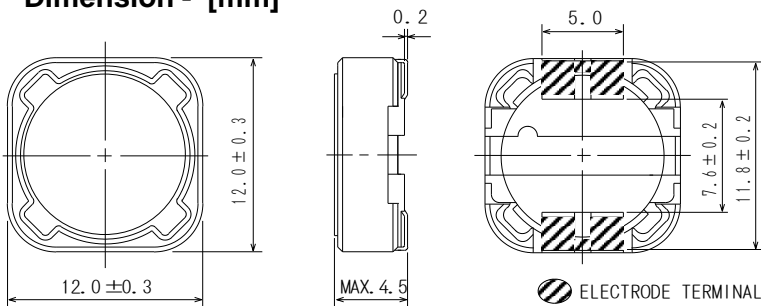

## Land pattern and Schematics - [mm]

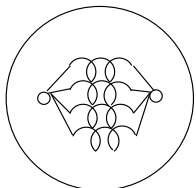
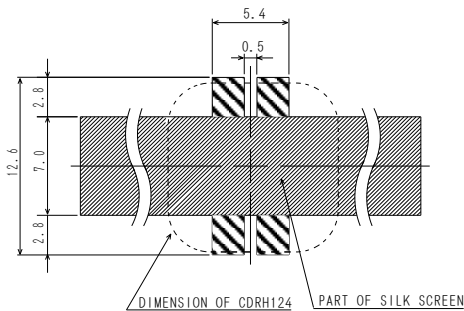

3.9µH~10µH

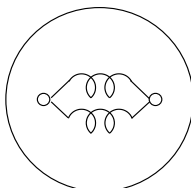

12µH~47µH,  
68µH,82µH

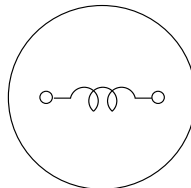

56µH,  
100µH~330µH



## Electrical Characteristics

| PART NO.        | STAMP | INDUCTANCE<br>[WITHIN]<br>※1 | D.C.R.<br>(mΩ)<br>(at 20°C)<br>MAX.(TYP.) | SATURATION<br>CURRENT<br>(A)※2<br>MAX.(TYP.) | TEMPERATURE<br>RISE CURRENT<br>(A)※3 |
|-----------------|-------|------------------------------|---|--|--------------------------------------|
| CDRH124NP-3R9MC | 3R9   | 3.9μH ± 20%                  | 15(12)                                    | 8.60(10.80)                                  | 7.30                                 |
| CDRH124NP-4R7MC | 4R7   | 4.7μH ± 20%                  | 18(14)                                    | 7.75(9.70)                                   | 6.60                                 |
| CDRH124NP-6R8MC | 6R8   | 6.8μH ± 20%                  | 23(18)                                    | 6.40(8.00)                                   | 5.90                                 |
| CDRH124NP-8R2MC | 8R2   | 8.2μH ± 20%                  | 26(21)                                    | 6.32(7.90)                                   | 5.40                                 |
| CDRH124NP-100MC | 100   | 10 μH ± 20%                  | 28(22)                                    | 5.60(7.00)                                   | 5.05                                 |
| CDRH124NP-120MC | 120   | 12 μH ± 20%                  | 38(30)                                    | 4.96(6.20)                                   | 4.55                                 |
| CDRH124NP-150MC | 150   | 15 μH ± 20%                  | 50(40)                                    | 4.32(5.40)                                   | 3.80                                 |
| CDRH124NP-180MC | 180   | 18 μH ± 20%                  | 57(46)                                    | 3.96(4.95)                                   | 3.72                                 |
| CDRH124NP-220MC | 220   | 22 μH ± 20%                  | 66(53)                                    | 3.80(4.75)                                   | 3.52                                 |
| CDRH124NP-270MC | 270   | 27 μH ± 20%                  | 80(64)                                    | 3.08(3.85)                                   | 3.30                                 |
| CDRH124NP-330MC | 330   | 33 μH ± 20%                  | 97(78)                                    | 2.96(3.70)                                   | 3.10                                 |
| CDRH124NP-390MC | 390   | 39 μH ± 20%                  | 132(106)                                  | 2.66(3.32)                                   | 2.55                                 |
| CDRH124NP-470MC | 470   | 47 μH ± 20%                  | 150(120)                                  | 2.56(3.20)                                   | 2.28                                 |
| CDRH124NP-560MC | 560   | 56 μH ± 20%                  | 190(152)                                  | 2.36(2.95)                                   | 2.10                                 |
| CDRH124NP-680MC | 680   | 68 μH ± 20%                  | 220(176)                                  | 2.14(2.67)                                   | 1.80                                 |
| CDRH124NP-820MC | 820   | 82 μH ± 20%                  | 260(208)                                  | 1.90(2.37)                                   | 1.55                                 |
| CDRH124NP-101MC | 101   | 100μH ± 20%                  | 308(246)                                  | 1.66(2.07)                                   | 1.40                                 |
| CDRH124NP-121MC | 121   | 120μH ± 20%                  | 380(304)                                  | 1.52(1.90)                                   | 1.32                                 |
| CDRH124NP-151MC | 151   | 150μH ± 20%                  | 530(424)                                  | 1.42(1.77)                                   | 1.20                                 |
| CDRH124NP-181MC | 181   | 180μH ± 20%                  | 620(496)                                  | 1.33(1.66)                                   | 1.06                                 |
| CDRH124NP-221MC | 221   | 220μH ± 20%                  | 700(560)                                  | 1.18(1.48)                                   | 0.93                                 |
| CDRH124NP-271MC | 271   | 270μH ± 20%                  | 870(696)                                  | 0.98(1.23)                                   | 0.76                                 |
| CDRH124NP-331MC | 331   | 330μH ± 20%                  | 990(792)                                  | 0.90(1.13)                                   | 0.65                                 |

※1 Measured frequency  $L$  at 100 kHz

※2 Saturation current: This indicates the value of D.C. current when the inductance becomes 25% lower than it's initial value. (Ta=20°C).

※3 Temperature rise current :The actual value of D.C. current when the temperature of coil becomes  $\Delta T=40^{\circ}\text{C}$  (Ta=20°C).

# SMD Power Inductor CDRH124

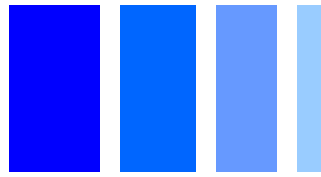

## Saturation Current & Temperature Rise Graph

— L (20°C) — L (100°C) —  $\Delta T$

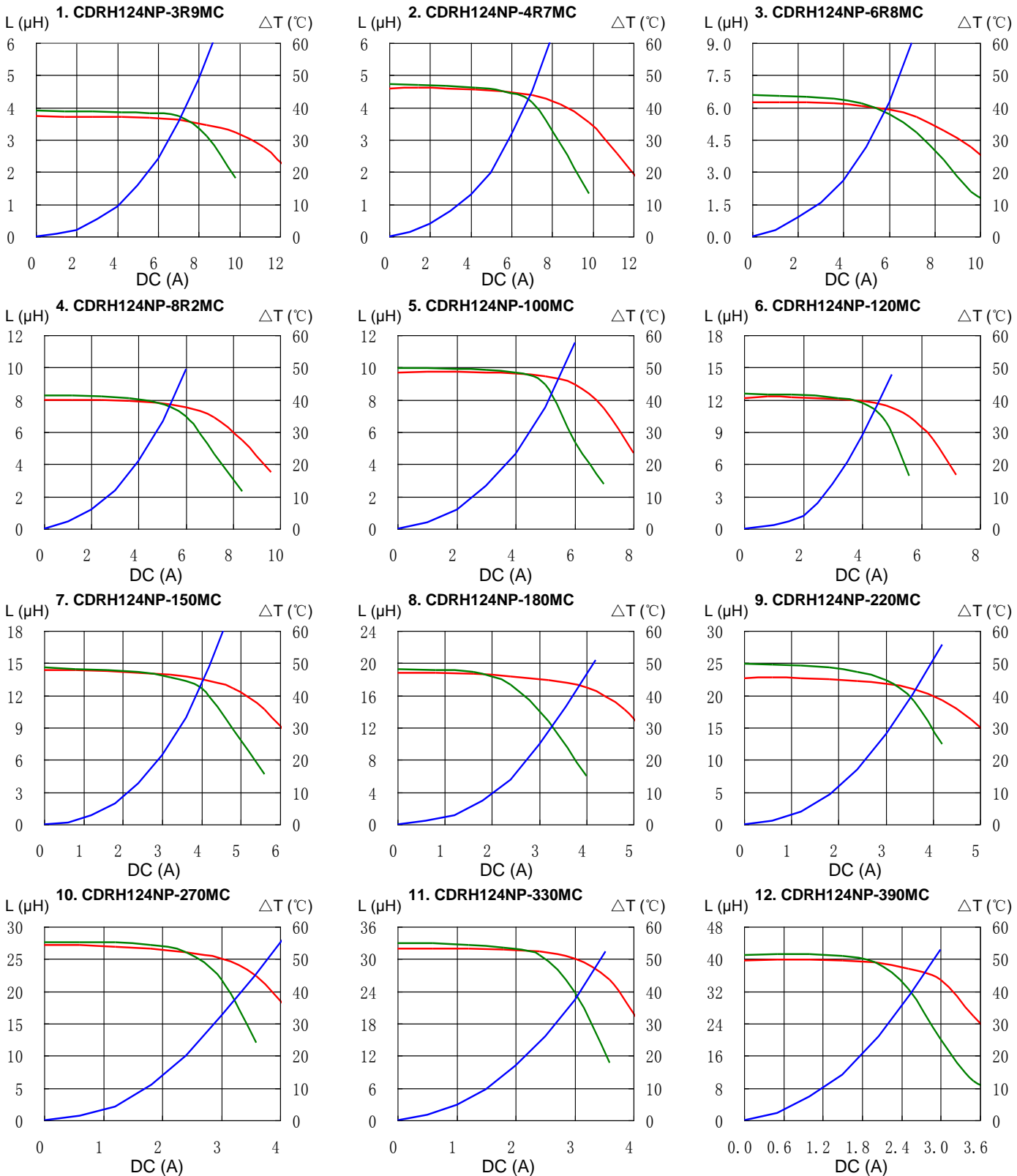

# SMD Power Inductor CDRH124



## Saturation Current & Temperature Rise Graph

— L (20°C) — L (100°C) —  $\Delta T$

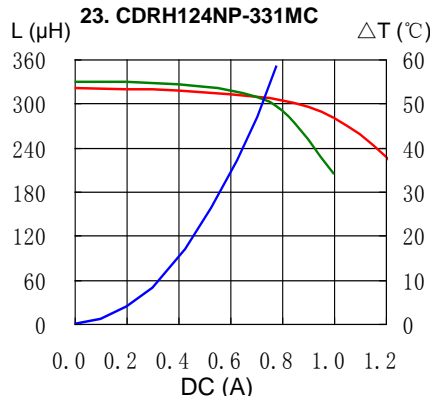
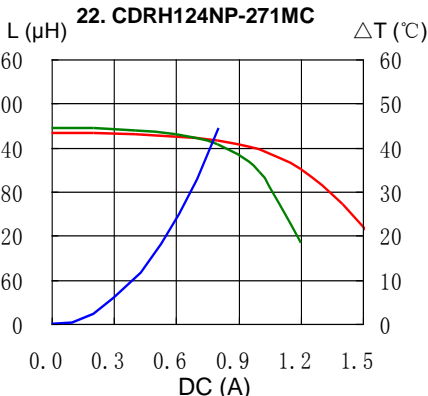
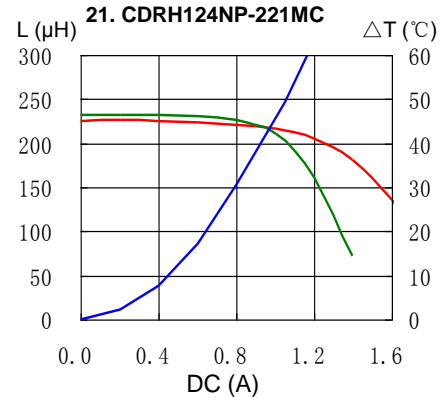
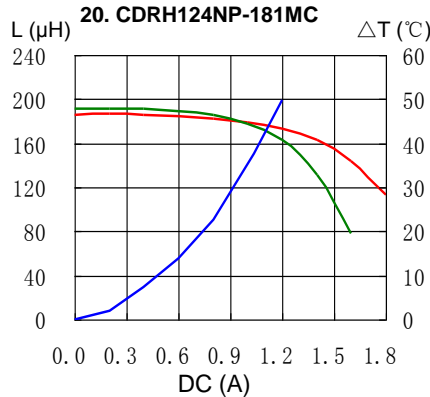
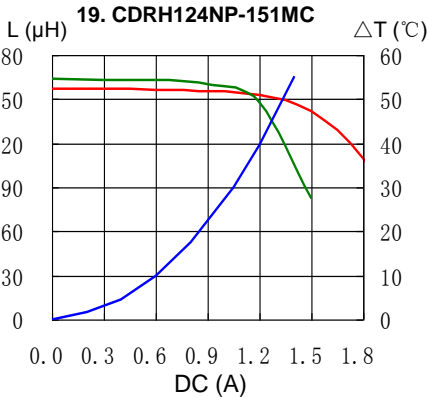
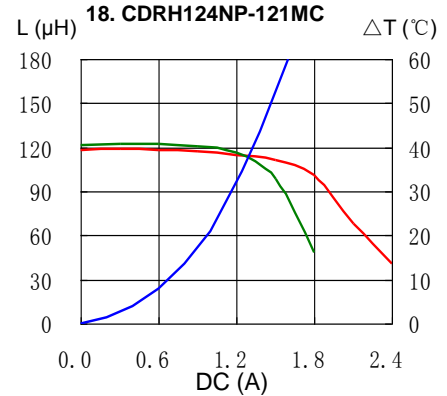
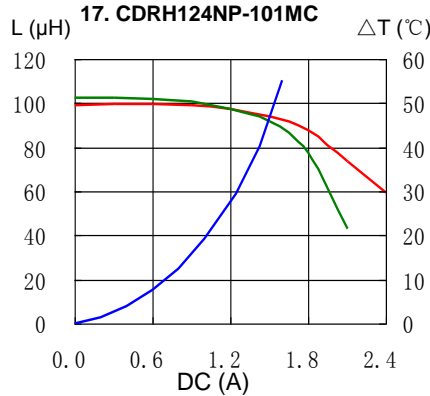
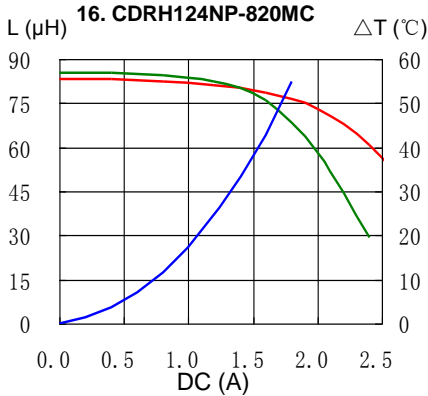
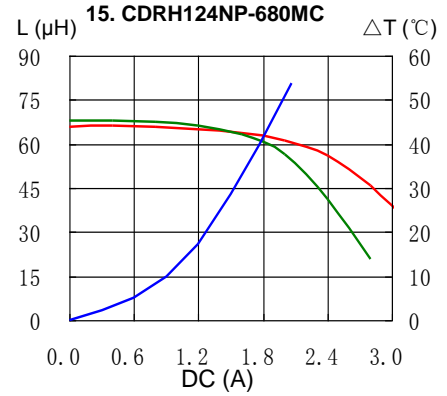
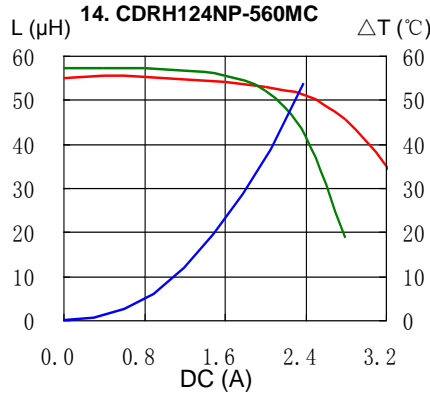
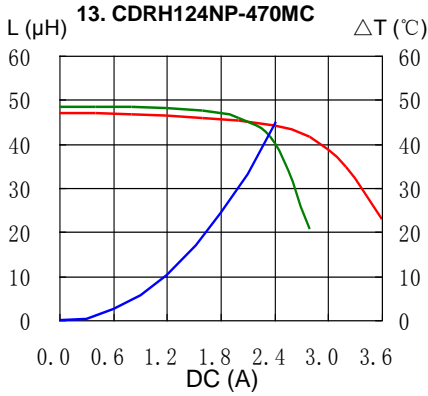

# SMD Power Inductor CDRH124

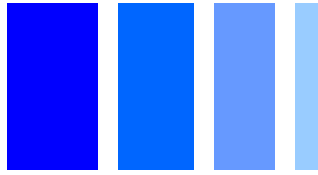

## Solder Reflow Condition

Heat Endurance



Temperature Chart



Please refer to the sales offices on our website - <http://www.sumida.com>

### Hong Kong

Tel.+852-2880-6781  
FAX.+852-2565-9600  
[sales@hk.sumida.com](mailto:sales@hk.sumida.com)

### Saitama(Japan)

Tel.+81-48-691-7300  
FAX.+81-48-691-7340  
[sales@jp.sumida.com](mailto:sales@jp.sumida.com)

### Chicago

Tel.+1-847-545-6700  
FAX. +1-847-545-6720  
[sales@us.sumida.com](mailto:sales@us.sumida.com)

### Shanghai

Tel.+86-21-5836-3299  
FAX.+86-21-5836-3266  
[shanghai.sales@cn.sumida.com](mailto:shanghai.sales@cn.sumida.com)

### Seoul

Tel.+82-2-6237-0777  
FAX.+82-2-6237-0778  
[sales@kr.sumida.com](mailto:sales@kr.sumida.com)

### Obernzell

Tel.+49-8591-937-0  
FAX. +49-8591-937-103  
[contact@eu.sumida.com](mailto:contact@eu.sumida.com)

### Shenzhen

Tel.+86-755-8291-0228  
FAX.+86-755-8291-0338  
[shenzhen.sales@cn.sumida.com](mailto:shenzhen.sales@cn.sumida.com)

### Singapore

Tel.+65-6296-3388  
FAX.+65-6841-4426  
[sales@sg.sumida.com](mailto:sales@sg.sumida.com)

### Neumarkt

Tel.+49-9181-4509-110  
FAX. +49-9181-4509-310  
[infocomp@eu.sumida.com](mailto:infocomp@eu.sumida.com)

### Taipei

Tel.+886-2-8751-2737  
FAX.+886-2-8751-2738  
[sales@tw.sumida.com](mailto:sales@tw.sumida.com)

### San Jose

Tel.+1-408-321-9660  
FAX.+1-408-321-9308  
[sales@us.sumida.com](mailto:sales@us.sumida.com)

## Looking for pricing, stock, or lifecycle information?

Click below to explore more details on WIN SOURCE:

- ⊖ [View CDRH124NP-680MC on WIN SOURCE](#)
- ⊖ [Sumida America Components Inc. Information](#)

## Optimize Your Supply Chain with WIN SOURCE Solutions

- ✓ Global Sourcing Solution
- ✓ Obsolete Management
- ✓ Cost Control Management
- ✓ Shortage Management
- ✓ Alternative Solution
- ✓ Excess Inventory Management