



**THE DATASHEET OF
AIAC-1812-68NJ-T**



SMT Air Coil Inductor

AIAC-1812

RoHS
Compliant

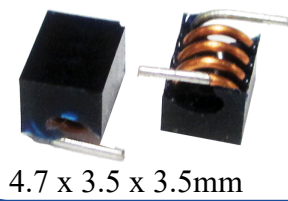

4.7 x 3.5 x 3.5mm

FEATURES:

- High current design
- Wide Range Frequency Response
- Excellent Q & SRF
- Standard flat cap top suitable for automatic placement.

APPLICATIONS:

- Widely used in Cordless Phones, High Frequency Communication Equipments, Intercom, CATV,RFID
- Suitable for metal sensors and proximity sensors
- Noise suppression for RF power supply/bias
- I/O filtering, frequency selection for audio devices such as Loudspeakers,Hifi
- Impedance Matching for transceivers
- Improves switch isolation for RF circuit

STANDARD SPECIFICATIONS:

PARAMETERS	
ABRACON P/N:	AIAC-1812
Operating temperature:	-40 °C ~ +125 °C
Storage temperature:	-25°C to + 60°C

Part Number	Inductance	Tolerance	DCR (Max)	Q(Min)	SRF(Min)	Rated Current (Max)	Inductance Code
Units	nH	%	mΩ		G Hz	A	
Symbol	L	J, K	DCR			IDC	
AIAC-1812-22N	22	K	4.8	100.0	3.20	3.2	22NK
AIAC-1812-27N	27	K	4.6	100.0	2.70	3.5	27NK
AIAC-1812-33N	33	K	5.9	100.0	2.50	3.0	33NK
AIAC-1812-39N	39	J	5.6	100.0	2.10	2.8	39NJ
AIAC-1812-47N	47	J	6.9	100.0	2.10	2.8	47NJ
AIAC-1812-56N	56	J	6.4	100.0	1.50	2.9	56NJ
AIAC-1812-68N	68	J	8.1	100.0	1.50	2.9	68NJ
AIAC-1812-82N	82	J	8.9	100.0	1.30	2.6	82NJ
AIAC-1812-R10	100	J	10.0	100.0	1.20	2.5	R10J
AIAC-1812-R12	120	J	11.1	100.0	1.10	2.2	R12J

Test Conditions and equipments

Test frequency: 150MHz

Equipment: HP4191A

PART IDENTIFICATION:

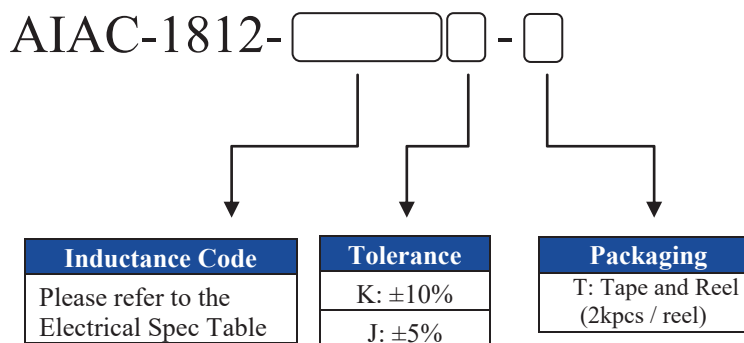

SMT Air Coil Inductor

AIAC-1812

RoHS
Compliant

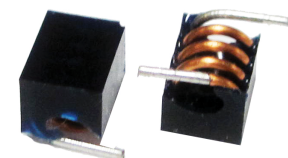

4.7 x 3.5 x 3.5mm

OUTLINE DRAWING:

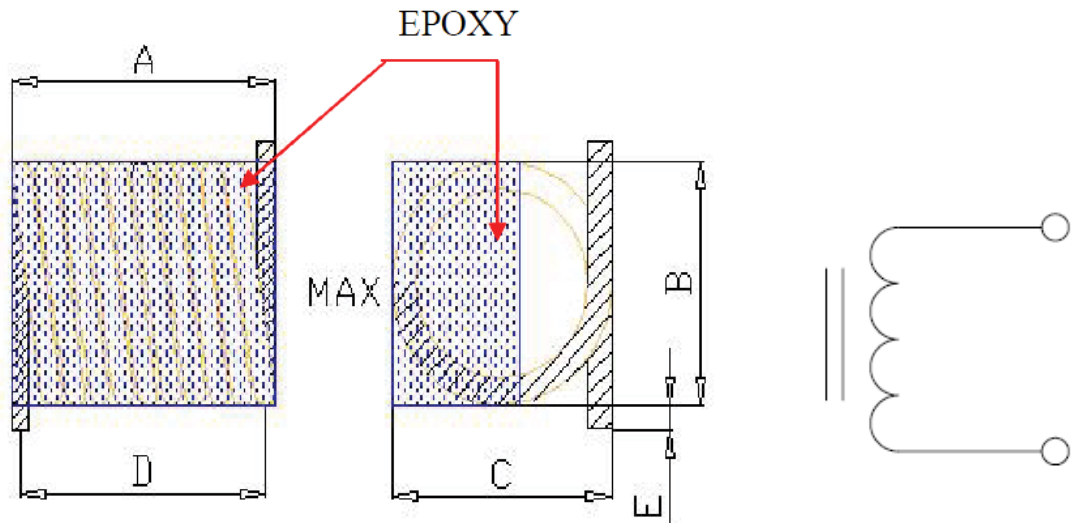

Inductance code	A	B	C	D	E
All others	4.7±0.3	3.5±0.2	3.5±0.2	4.3±0.4	1.0±0.3
R12J only	4.9±0.3	3.8±0.2	3.8±0.2		

Recommended Landing Pattern

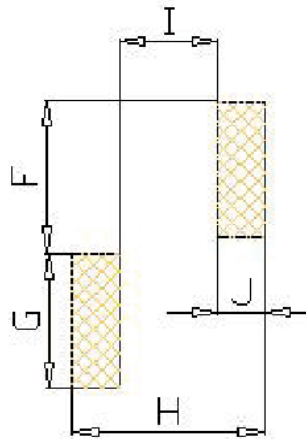

F	G	H	I	J
2.7	5.2	5.8	2.9	1.5

Dimension: inch (mm)

SMT Air Coil Inductor

AIAC-1812

RoHS
Compliant

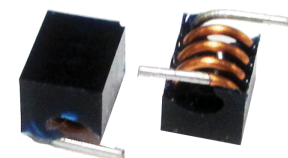

4.7 x 3.5 x 3.5mm

REFLOW PROFILE:

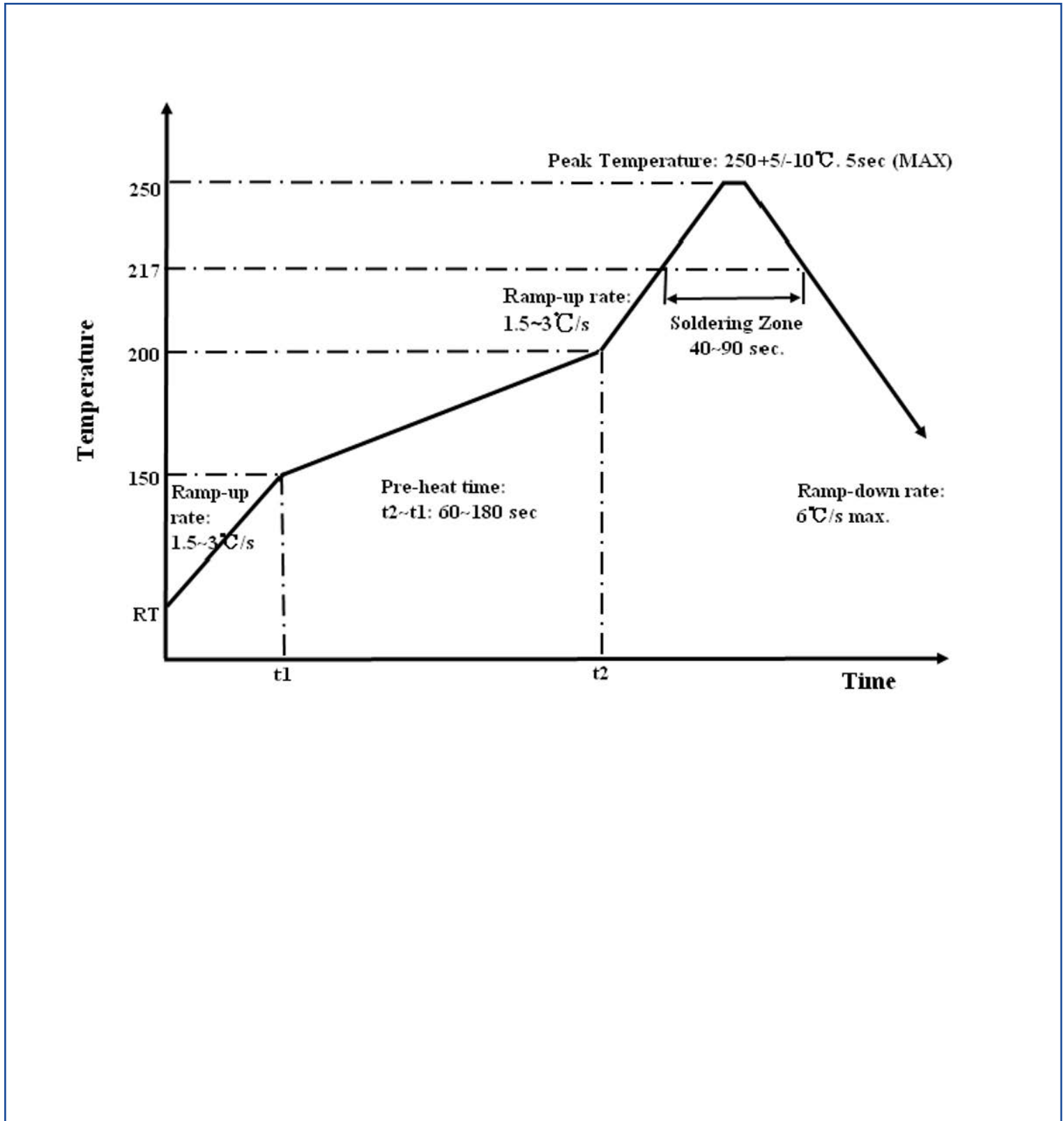

SMT Air Coil Inductor

AIAC-1812

RoHS
Compliant

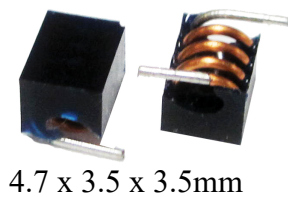

4.7 x 3.5 x 3.5mm

TAPE & REEL:

Packing
T: 2Kpcs / reel

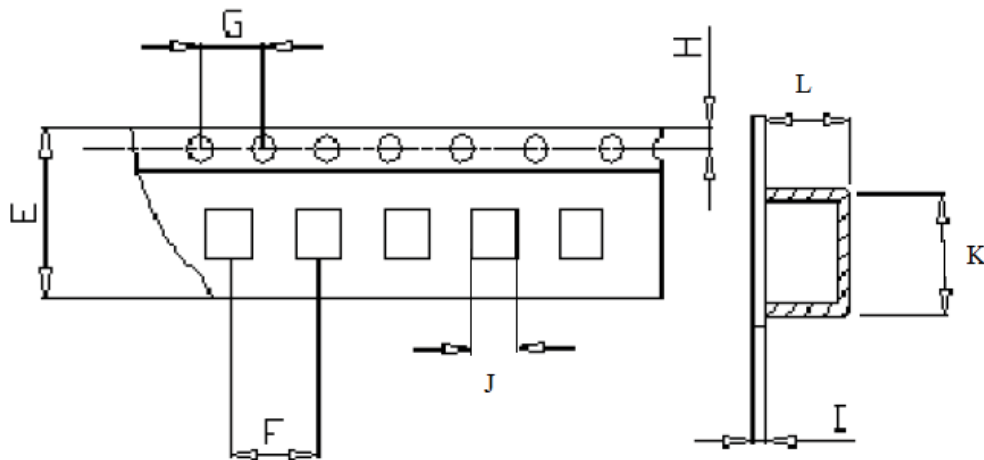

E	F	G	H	I	J max	K max	L max
16	8	4	1.75	0.4	5.70±0.1	7.10±0.1	4.20±0.1

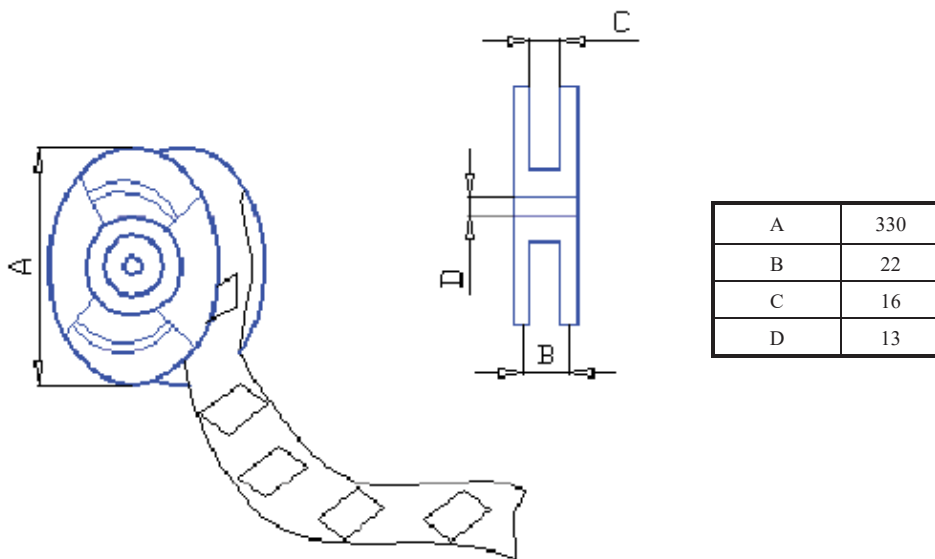

A	330
B	22
C	16
D	13

Dimension: mm

ATTENTION: Abracon Corporation's products are COTS – Commercial-Off-The-Shelf products; suitable for Commercial, Industrial and, where designated, Automotive Applications. Abracon's products are not specifically designed for Military, Aviation, Aerospace, Life-dependant Medical applications or any application requiring high reliability where component failure could result in loss of life and/or property. For applications requiring high reliability and/or presenting an extreme operating environment, written consent and authorization from Abracon Corporation is required. Please contact Abracon Corporation for more information.

Looking for pricing, stock, or lifecycle information?

Click below to explore more details on WIN SOURCE:

 [View AIAC-1812-68NJ-T on WIN SOURCE](#)

 [Abracon LLC Information](#)

Optimize Your Supply Chain with WIN SOURCE Solutions

-  Global Sourcing Solution
-  Obsolete Management
-  Cost Control Management
-  Shortage Management
-  Alternative Solution
-  Excess Inventory Management