



**THE DATASHEET OF
ASD1-18.432MHZ-LR-T**



HCMOS SMD Crystal Oscillator



ASD

2.5 X 2.0 X 1.0 mm

ASD SERIES



ESD Sensitive



RoHS/RoHS II compliant

Moisture Sensitivity Level (MSL) – This product is Hermetically Sealed and not Moisture Sensitive - MSL = N/A: Not Applicable

For Vdd=3.3V & 2.5V and custom frequencies between 8.00MHz & 200.000MHz, or carrier frequency > 60.0MHz, please consider Abracon's [ASG2-C series](#) of XO and VCXO's

FEATURES:

- Low height 1.0mm max
- Low current consumption
- Tri-state function
- Suitable for RoHS compliant reflow
- Tight stability option
- Seam sealed package assures high reliability

APPLICATIONS:

- CCD clock for VTR Camera
- Equipment connected to PC or PC cards
- Thin equipment

STANDARD SPECIFICATIONS:

Parameters		Minimum	Typical	Maximum	Units	Notes
Frequency Range		0.750		60	MHz	
Operating Temperature		-20		+70	°C	STD temp. Option code E (See options)
Storage Temperature		-55		+100	°C	
Overall Frequency Stability		-100		+100	ppm	See options
Supply Voltage (Vdd)		+3.135	+3.3	+3.465	V	ASD (Standard)
		+2.85	+3.0	+3.15		ASD1
		+2.375	+2.5	+2.625		ASD2
		+1.71	+1.8	+1.89		ASD3
		+0.95	+1.0	+1.05		ASD6
Input Current (Idd)	ASD (3.3V)		2.5	5	mA	0.750~15.999 MHz
			4	7		16.000~39.999 MHz
			9	13		40.000~60.000 MHz
	ASD1 (3.0V)		2.5	4	mA	0.750~15.999 MHz
			3.5	6		16.000~39.999 MHz
			8	12		40.000~60.000 MHz
	ASD2 (2.5V)		2	3.5	mA	0.750~15.999 MHz
			3	5		16.000~39.999 MHz
			7	10		40.000~60.000 MHz
	ASD3 (1.8V)		1	2.5	mA	0.750~15.999 MHz
			2	4		16.000~39.999 MHz
			4	7		40.000~60.000 MHz
ASD6 (1.0V)		1.0	2.5	mA	25.000 MHz	
Symmetry @ 1/2Vdd		40		60	%	STD (See option)
Output Load:				15	pF	CMOS
Output Voltage (VOH):		0.9* Vdd			V	
Output Voltage (VOL):				0.1* Vdd	V	



HCMOS SMD Crystal Oscillator

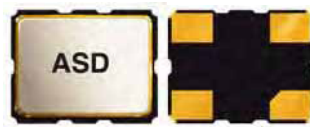

ASD SERIES



RoHS/RoHS II compliant

2.5 X 2.0 X 1.0 mm

(Continued)

Parameters		Minimum	Typical	Maximum	Units	Notes	
Rise and Fall Time (Tr/Tf):	ASD (3.3V)		3	7	ns	0.750~15.999 MHz	
			2.5	6		16.000~39.999 MHz	
			2	4		40.000~60.000 MHz	
	ASD1 (3.0V)		3	7	ns	0.750~15.999 MHz	
			2.5	6		16.000~39.999 MHz	
			2	4		40.000~60.000 MHz	
	ASD2 (2.5V)		4	8	ns	0.750~15.999 MHz	
			3	7		16.000~39.999 MHz	
			2.5	5		40.000~60.000 MHz	
	ASD3 (1.8V)		5	10	ns	0.750~15.999 MHz	
			3.5	8		16.000~39.999 MHz	
			3	6		40.000~60.000 MHz	
	ASD6 (1.0V)		1.9	6.0	ns	25.000 MHz	
	Start-up Time:	ASD (3.3V)		6	10	ms	0.750~15.999 MHz
				6	10		16.000~39.999 MHz
			5	10	40.000~60.000 MHz		
ASD1 (3.0V)			6	10	ms	0.750~15.999 MHz	
			6	10		16.000~39.999 MHz	
			5	10		40.000~60.000 MHz	
ASD2 (2.5V)			6	10	ms	0.750~15.999 MHz	
			6	10		16.000~39.999 MHz	
			5	10		40.000~60.000 MHz	
ASD3 (1.8V)			6	10	ms	0.750~15.999 MHz	
			6	10		16.000~39.999 MHz	
			5	10		40.000~60.000 MHz	
ASD6 (1.0V)			2.0	10	ms	25.000 MHz	
Tri-state function (Stand-by) :		"1" (VIH≥0.7*Vdd) or Open: Oscillation; "0" (VIH<0.3*Vdd) : No oscillation/Hi Z					
Phase Jitter (12kHz to 20MHz)		ASD (3.3V)		0.4	1.0	ps	0.750~15.999 MHz
			0.4	1.0	16.000~39.999 MHz		
			0.3	1.0	40.000~60.000 MHz		
	ASD1 (3.0V)		0.4	1.0	ps	0.750~15.999 MHz	
			0.4	1.0		16.000~39.999 MHz	
			0.3	1.0		40.000~60.000 MHz	
	ASD2 (2.5V)		0.5	1.0	ps	0.750~15.999 MHz	
			0.5	1.0		16.000~39.999 MHz	
			0.5	1.0		40.000~60.000 MHz	
	ASD3 (1.8V)		0.5	1.0	ps	0.750~15.999 MHz	
			0.5	1.0		16.000~39.999 MHz	
			0.5	1.0		40.000~60.000 MHz	
	ASD6 (1.0V)		0.3	1.0	ps	25.000 MHz	
	Period Jitter RMS	ASD (3.3V)		3.0	5.0	ps	0.750~15.999 MHz
				3.0	5.0		16.000~39.999 MHz
			3.0	5.0	40.000~60.000 MHz		
ASD1 (3.0V)			3.0	5.0	ps	0.750~15.999 MHz	
			3.0	5.0		16.000~39.999 MHz	
			3.0	5.0		40.000~60.000 MHz	
ASD2 (2.5V)			3.0	5.0	ps	0.750~15.999 MHz	
			3.0	5.0		16.000~39.999 MHz	
			3.0	5.0		40.000~60.000 MHz	
ASD3 (1.8V)			3.0	5.0	ps	0.750~15.999 MHz	
			3.0	5.0		16.000~39.999 MHz	
			3.0	5.0		40.000~60.000 MHz	
ASD6 (1.0V)			4.8	6.0	ps	25.000 MHz	
Aging at 25°C/year		-5		+5	ppm		
Disable Current:				20	µA		

HCMOS SMD Crystal Oscillator



2.5 X 2.0 X 1.0 mm

ASD SERIES

OPTIONS AND PART IDENTIFICATION:

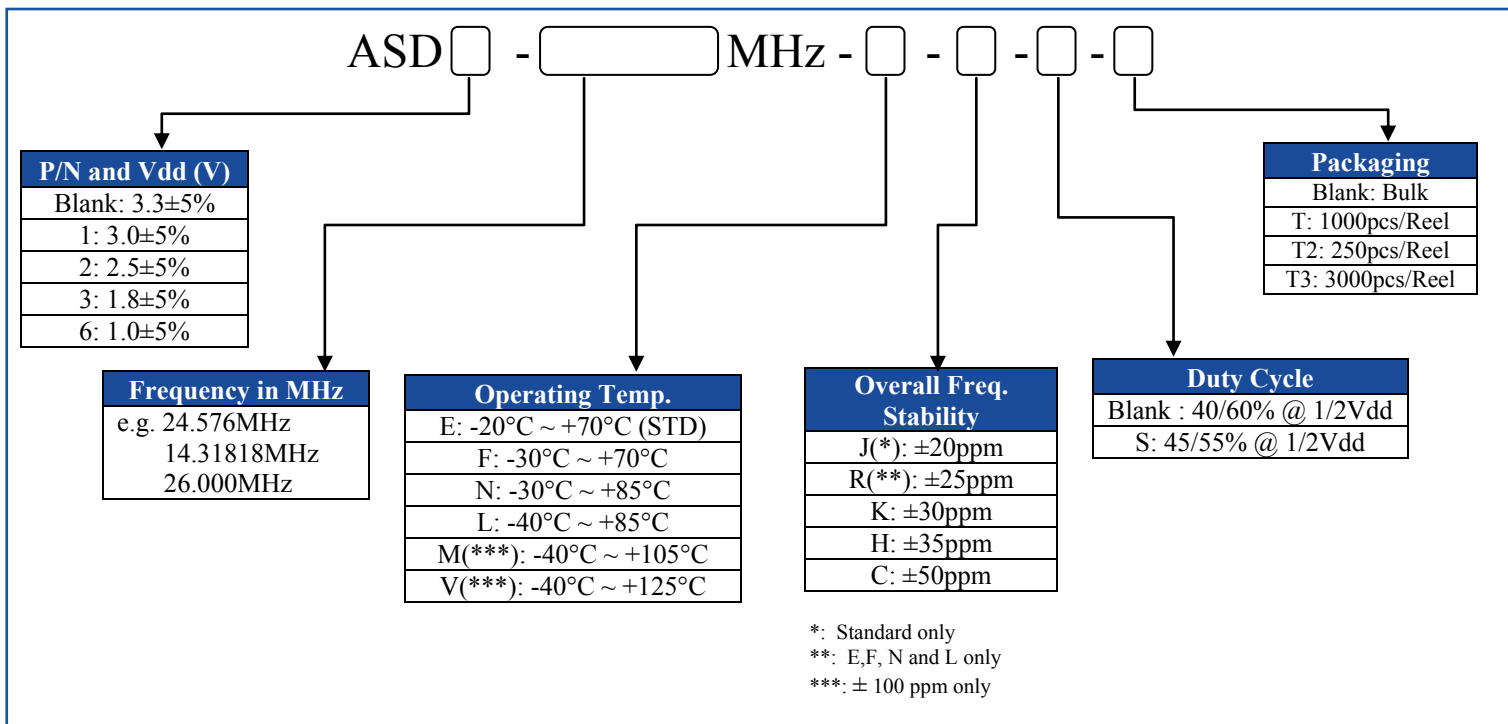

OUTLINE DRAWING:

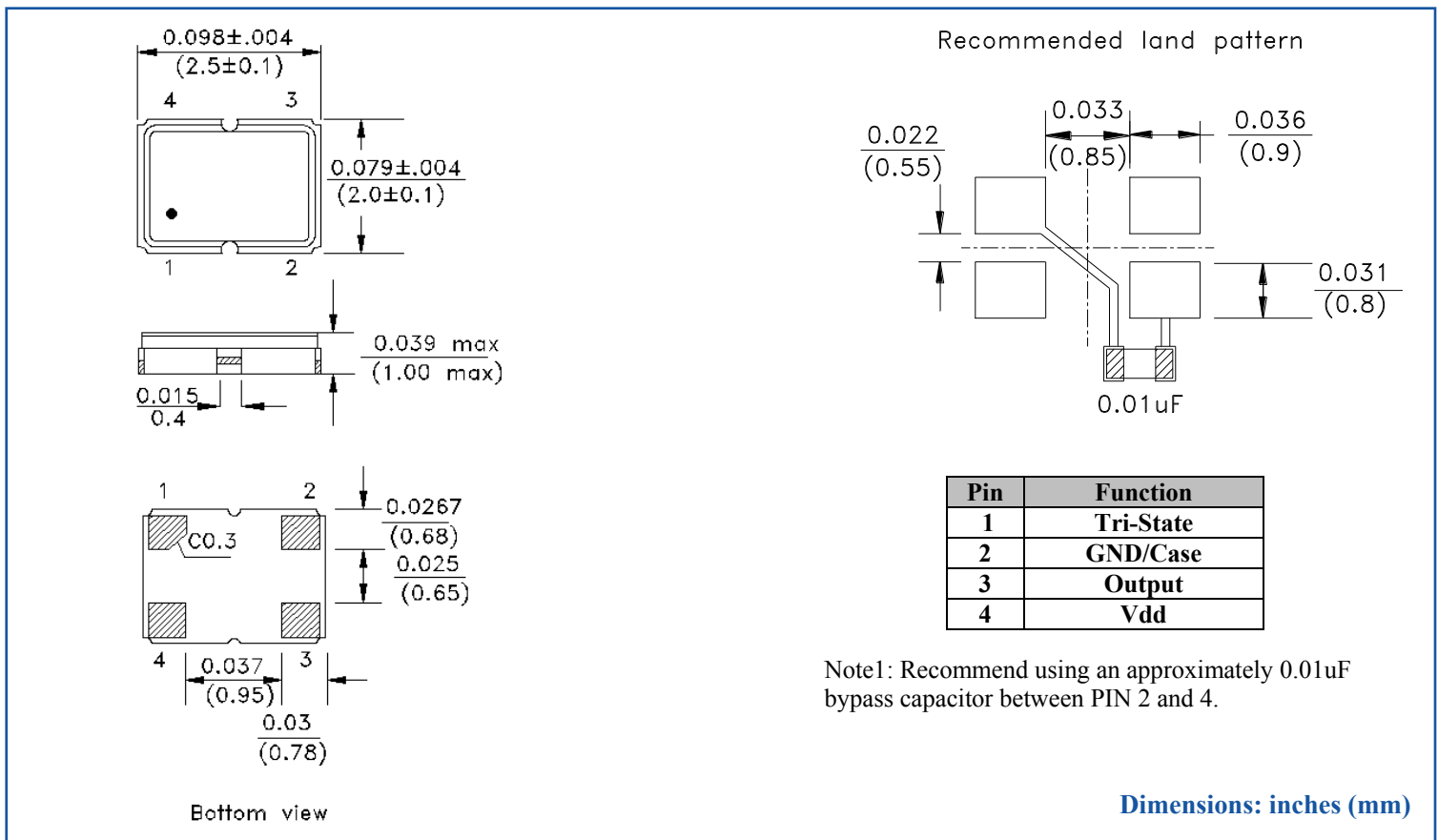

HCMOS SMD Crystal Oscillator

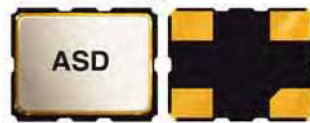

ASD

2.5 X 2.0 X 1.0 mm

ASD SERIES

TAPE & REEL:

T: 1000pcs/reel
T2: 250pcs/reel
T3: 3000pcs/reel

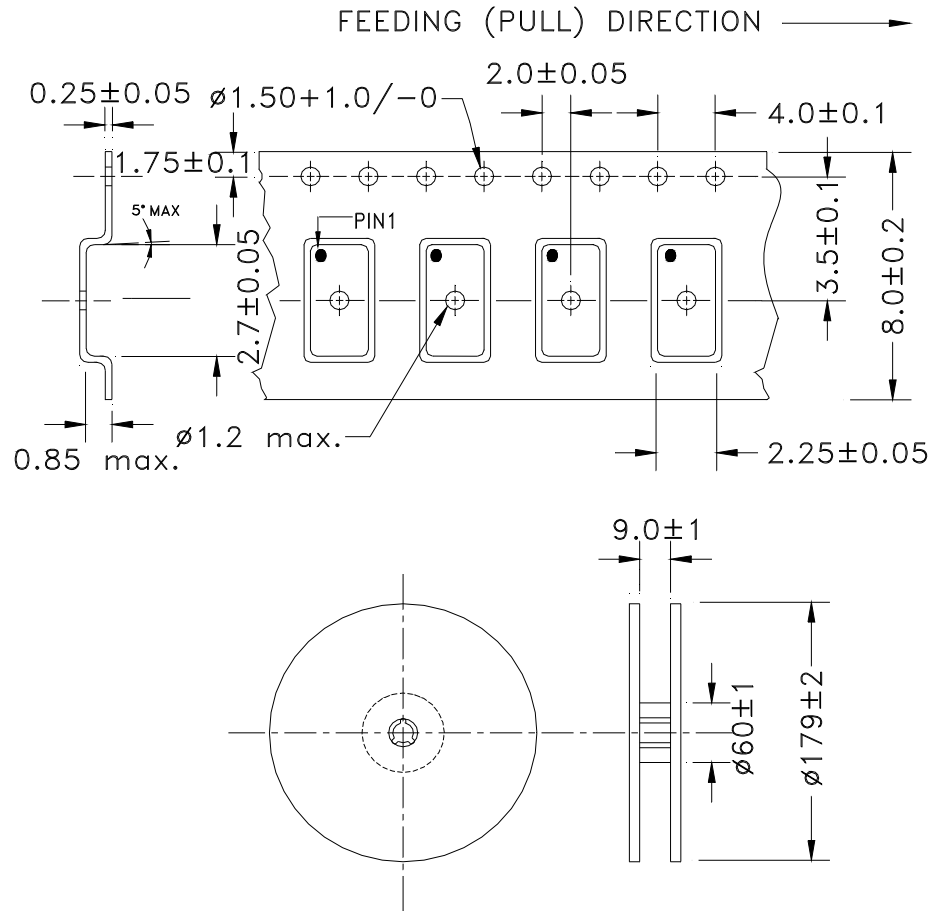

Dimensions: mm

REFLOW PROFILE:

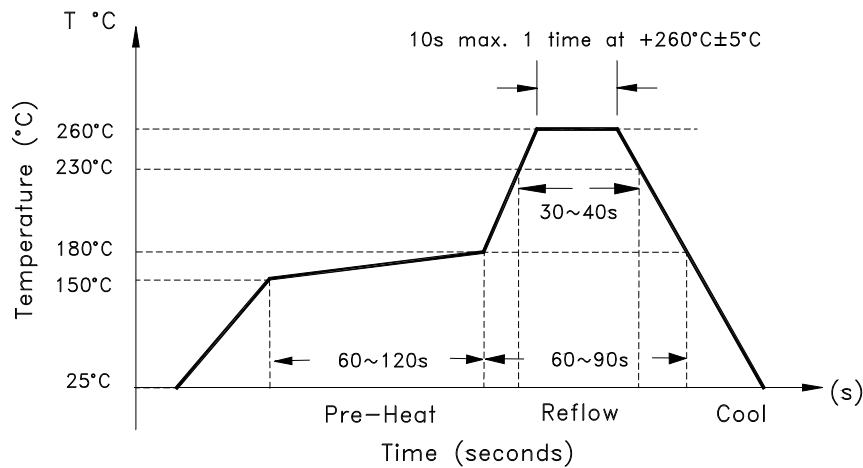

ATTENTION: Abracon Corporation's products are COTS – Commercial-Off-The-Shelf products; suitable for Commercial, Industrial and, where designated, Automotive Applications. Abracon's products are not specifically designed for Military, Aviation, Aerospace, Life-dependant Medical applications or any application requiring high reliability where component failure could result in loss of life and/or property. For applications requiring high reliability and/or presenting an extreme operating environment, written consent and authorization from Abracon Corporation is required. Please contact Abracon Corporation for more information.

Need a test socket for the ASD Series? To view compatible **PRECISION TEST & BURN-IN SOCKETS** for these parts, [click here. P/N AXS-2520-04-01](#)

ABRACON IS
ISO9001:2008
CERTIFIED



Visit www.abracon.com for Terms & Conditions of Sale **Revised: 01.19.15**
30332 Esperanza, Rancho Santa Margarita, California 92688
tel 949-546-8000 | fax 949-546-8001 | www.abracon.com

Looking for pricing, stock, or lifecycle information?

Click below to explore more details on WIN SOURCE:

 [View ASD1-18.432MHZ-LR-T on WIN SOURCE](#)

 [Abracon LLC Information](#)

Optimize Your Supply Chain with WIN SOURCE Solutions

-  Global Sourcing Solution
-  Obsolete Management
-  Cost Control Management
-  Shortage Management
-  Alternative Solution
-  Excess Inventory Management