

0.3mm Contact Pitch, 1mm above the board, Flexible Printed Circuit ZIF Connectors

FH26 Series

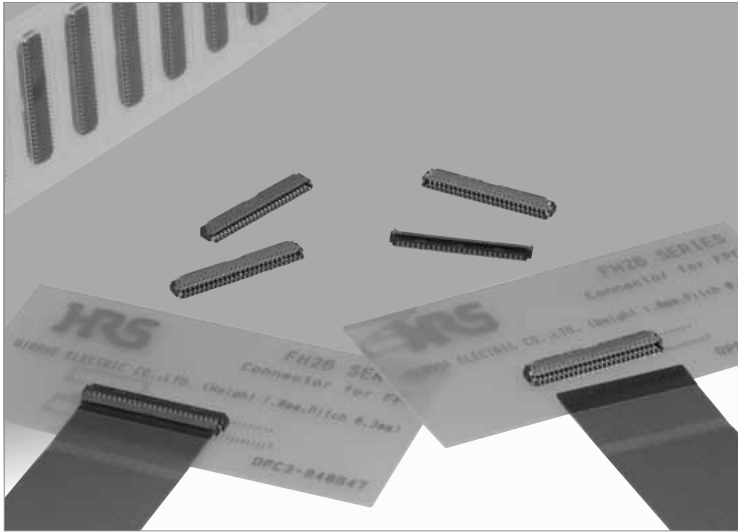

●Space saving(51 pos. shown)

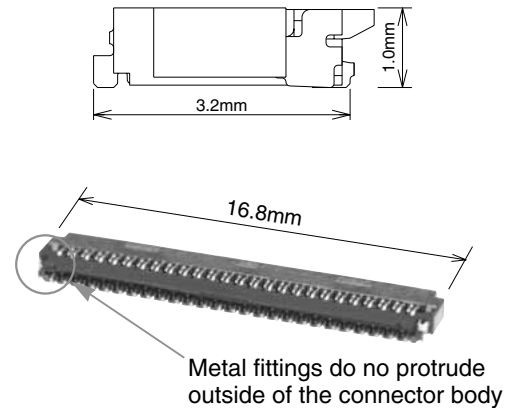

■Features

1. Extremely light weight

The typical version, with all 51 contacts loaded, weights only 0.1 grams.

2. Easy solderability on the PC board

The soldering leads are on 0.6 mm pitch, exiting on front and back of the connector.

3. Conductive traces on the PCB can run under the connector

No exposed contacts on the bottom of the connector.

4. Easy FPC insertion and reliable electrical connection

Proven Flip LockR actuator allows easy insertion of FPC. Tactile sensation when fully closed confirms complete electrical and mechanical connection.

5. Accepts standard thickness FPC

0.2mm thick standard Flexible Printed Circuit board can be used.

This is the only ultra-low profile ZIF connector allowing the use of standard FPC.

6. Board placement with automatic equipment

Flat top surface and packaging on the tape-and-reel allows use of vacuum nozzles.

Standard reel contains 5,000 connectors.

7. The connector does not use chlorine and bromine exceeding standard limits. (FH26W series)

* Defined in accordance with IEC61249-2-21

Br 900ppm or lower, Cl 900ppm or lower, Br + Cl 1,500ppm or lower

8. Available for 500 pieces packaging

Although the normal product is 5,000 pieces per reel, 500 winds per reel is also available.

(Emboss reel external diameter is ϕ 180mm.)

●Can be mounted over conductive traces.

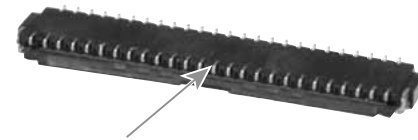

No exposed contacts on the bottom of the connector

●Operation

- (1) Actuator open
- (2) Insert FPC

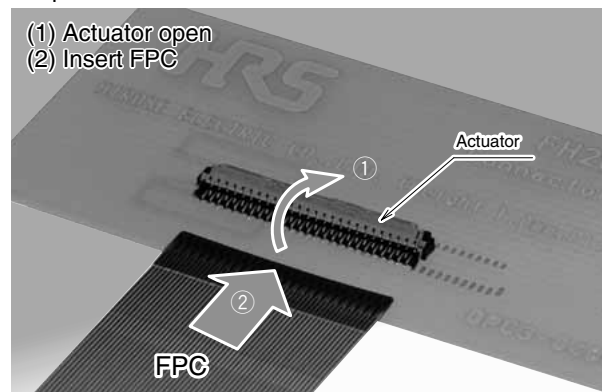

- (3) Close the actuator
- (4) FPC connected

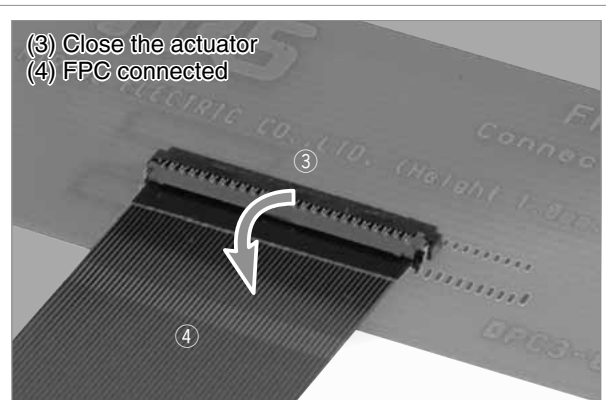

■ Specifications

Rating	Current rating Voltage rating	0.2A DC 30V AC	Operating temperature range Operating humidity range	-55 °C to +85°C (Note 1) Relative humidity 90% max. (No condensation)	Storage temperature range Storage humidity range	-10°C to +50°C (Note 2) Relative humidity 90% max.
--------	----------------------------------	-------------------	---	--	---	---

Recommended FPC :	Thickness: = 0.2±0.03mm gold plated
-------------------	-------------------------------------

Item	Specification	Conditions
1. Insulation resistance	50 M ohms min.	100 V DC
2. Withstanding voltage	No flashover or insulation breakdown.	90 V AC /one minute
3. Contact resistance	100 m ohms max. * Including FPC conductor resistance	1 mA
4. Durability (Insertion/ withdrawal)	Contact resistance: 100 m ohms max. No damage, cracks, or parts dislocation.	10 cycles
5. Vibration	No electrical discontinuity of 1µs or more. Contact resistance: 100 m ohms max. No damage, cracks, or parts dislocation.	Frequency: 10 to 55 Hz, single amplitude of 0.75 mm, 10 cycles, 3 directions.
6. Shock	No electrical discontinuity of 1µs. min. Contact resistance: 100 m ohms max. No damage, cracks, or parts dislocation.	Acceleration of 981 m/s ² , 6 ms duration, sine half-wave waveform, 3 cycles in each of the 3 axis
7. Humidity (Steady state)	Contact resistance: 100 m ohms max. Insulation resistance: 50 M ohms min. No affect on appearance or performance.	96 hours at temperature of 40±2°C and humidity of 90% to 95%.
8. Temperature cycle	Contact resistance: 100 m ohms max. Insulation resistance: 50 M ohms min. No damage, cracks, or parts looseness.	Temperature: -55 °C→+15°C to +35°C→+85°C→+15°C to +35°C Time: 30 → 2 to 3 → 30 → 2 to 3 (Minutes) 5 cycles
9. Resistance to soldering heat	No deformation of components affecting performance.	Reflow: At the recommended temperature profile Manual soldering: 350°C +/-10°C for 5±1 seconds

Note 1: Includes temperature rise caused by current flow.

Note 2: The term "storage" refers to products stored for long period of time prior to mounting and use. Operating Temperature Range and Humidity range covers non- conducting condition of installed connectors in storage, shipment or during transportation.

■ Materials

Part	Material	Finish	Remarks
Insulator	LCP	Color: Black	UL94V-0
	PA	FH26 series: Deep brown	
		FH26W series: Light brown	
Contacts	Phosphor bronze	Gold plating	_____
Metalfittings		Pure tin reflow plating	_____

■ Ordering information

FH 26 W - 51S - 0.3 SHW (05)

① ② ③ ④ ⑤ ⑥ ⑦

① Series name: FH	⑥ Termination type SHW: SMT horizontal staggered mounting type
② Series No.: 26	⑦ Specifications (05)...Gold plating, 5,000 pieces / reel (10)...Gold plating with nickel barrier, 5,000 pieces / reel (98)...Gold plating, 500 pieces / reel (99)...Gold plating with nickel barrier, 500 pieces / reel
③ Blank: Standard W: Satisfies halogen-free requirements (Flame retardance UL94HB).	
④ Number of positions: 13 to 71	
⑤ Contact pitch: 0.3mm	

Connector Dimensions

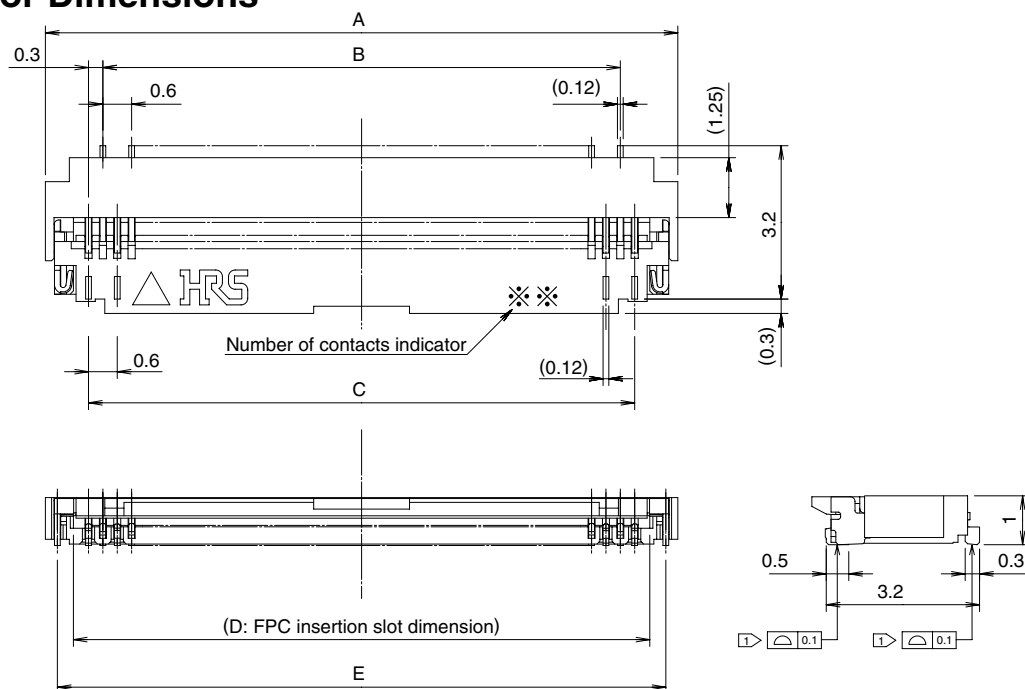

- Notes
- ① The coplanarity of each terminal lead within specified dimension is 0.1 mm Max.
 - 2 Packaged on tape and reel only. Check packaging specification.
 - 3 Slight variations in color of the plastic compounds do not affect form, fit or function of the connector.
 - 4 After reflow, the terminal plating may change color, however this does not represent a quality issue.

All dimensions: mm

Part Number	CL No.	Number of Contacts	A	B	C	D	E
FH26-13S-0.3SHW(**)	580-0209-3-**-	13	5.4	3.0	3.6	4.23	4.9
FH26-15S-0.3SHW(**)	580-0218-4-**-	15	6.0	3.6	4.2	4.83	5.5
FH26-17S-0.3SHW(**)	580-0217-1-**-	17	6.6	4.2	4.8	5.43	6.1
FH26-21S-0.3SHW(**)	580-0207-8-**-	21	7.8	5.4	6.0	6.63	7.3
FH26-23S-0.3SHW(**)	580-0203-7-**-	23	8.4	6.0	6.6	7.23	7.9
FH26-25S-0.3SHW(**)	580-0208-0-**-	25	9.0	6.6	7.2	7.83	8.5
FH26-27S-0.3SHW(**)	580-0204-0-**-	27	9.6	7.2	7.8	8.43	9.1
FH26-29S-0.3SHW(**)	580-0216-9-**-	29	10.2	7.8	8.4	9.03	9.7
FH26-31S-0.3SHW(**)	580-0214-3-**-	31	10.8	8.4	9.0	9.63	10.3
FH26-33S-0.3SHW(**)	580-0210-2-**-	33	11.4	9.0	9.6	10.23	10.9
FH26-35S-0.3SHW(**)	580-0205-2-**-	35	12.0	9.6	10.2	10.83	11.5
FH26-37S-0.3SHW(**)	580-0224-7-**-	37	12.6	10.2	10.8	11.43	12.1
FH26-39S-0.3SHW(**)	580-0201-1-**-	39	13.2	10.8	11.4	12.03	12.7
FH26-41S-0.3SHW(**)	580-0206-5-**-	41	13.8	11.4	12.0	12.63	13.3
FH26-45S-0.3SHW(**)	580-0211-5-**-	45	15.0	12.6	13.2	13.83	14.5
FH26-51S-0.3SHW(**)	580-0200-9-**-	51	16.8	14.4	15.0	15.63	16.3
FH26-55S-0.3SHW(**)	580-0221-9-**-	55	18.0	15.6	16.2	16.83	17.5
FH26-57S-0.3SHW(**)	580-0212-8-**-	57	18.6	16.2	16.8	17.43	18.1
FH26-61S-0.3SHW(**)	580-0213-0-**-	61	19.8	17.4	18.0	18.63	19.3
FH26-71S-0.3SHW(**)	580-0202-4-**-	71	22.8	20.4	21.0	21.63	22.3

Part Number	CL No.	Number of Contacts	A	B	C	D	E
FH26W-13S-0.3SHW(**)	580-2401-1-**-	13	5.4	3	3.6	4.23	4.9
FH26W-15S-0.3SHW(**)	580-2402-4-**-	15	6.0	3.6	4.2	4.83	5.5
FH26W-17S-0.3SHW(**)	580-2403-7-**-	17	6.6	4.2	4.8	5.43	6.1
FH26W-19S-0.3SHW(**)	580-2437-9-**-	19	7.2	4.8	5.4	6.03	6.7
FH26W-21S-0.3SHW(**)	580-2404-0-**-	21	7.8	5.4	6.0	6.63	7.3
FH26W-23S-0.3SHW(**)	580-2405-2-**-	23	8.4	6.0	6.6	7.23	7.9
FH26W-25S-0.3SHW(**)	580-2406-5-**-	25	9.0	6.6	7.2	7.83	8.5
FH26W-27S-0.3SHW(**)	580-2400-9-**-	27	9.6	7.2	7.8	8.43	9.1
FH26W-29S-0.3SHW(**)	580-2407-8-**-	29	10.2	7.8	8.4	9.03	9.7
FH26W-31S-0.3SHW(**)	580-2408-0-**-	31	10.8	8.4	9.0	9.63	10.3
FH26W-33S-0.3SHW(**)	580-2409-3-**-	33	11.4	9.0	9.6	10.23	10.9
FH26W-35S-0.3SHW(**)	580-2410-2-**-	35	12.0	9.6	10.2	10.83	11.5
FH26W-37S-0.3SHW(**)	580-2411-5-**-	37	12.6	10.2	10.8	11.43	12.1
FH26W-39S-0.3SHW(**)	580-2412-8-**-	39	13.2	10.8	11.4	12.03	12.7
FH26W-41S-0.3SHW(**)	580-2413-0-**-	41	13.8	11.4	12.0	12.63	13.3
FH26W-45S-0.3SHW(**)	580-2414-3-**-	45	15.0	12.6	13.2	13.83	14.5
FH26W-51S-0.3SHW(**)	580-2415-6-**-	51	16.8	14.4	15.0	15.63	16.3
FH26W-57S-0.3SHW(**)	580-2417-1-**-	57	18.6	16.2	16.8	17.43	18.1
FH26W-61S-0.3SHW(**)	580-2418-4-**-	61	19.8	17.4	18.0	18.63	19.3
FH26W-71S-0.3SHW(**)	580-2419-7-**-	71	22.8	20.4	21.0	21.63	22.3

- Note1 : Embossed tape reel packaging. Order by number of reels.
 Note2 : **: Specification. Refer to ordering information.

Recommended PCB mounting pattern and metal mask dimensions

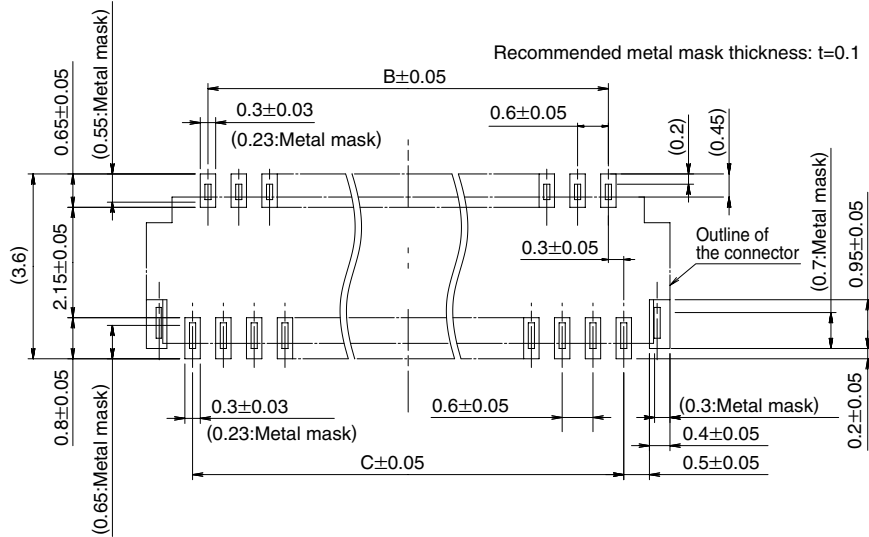

Recommended FPC Dimensions

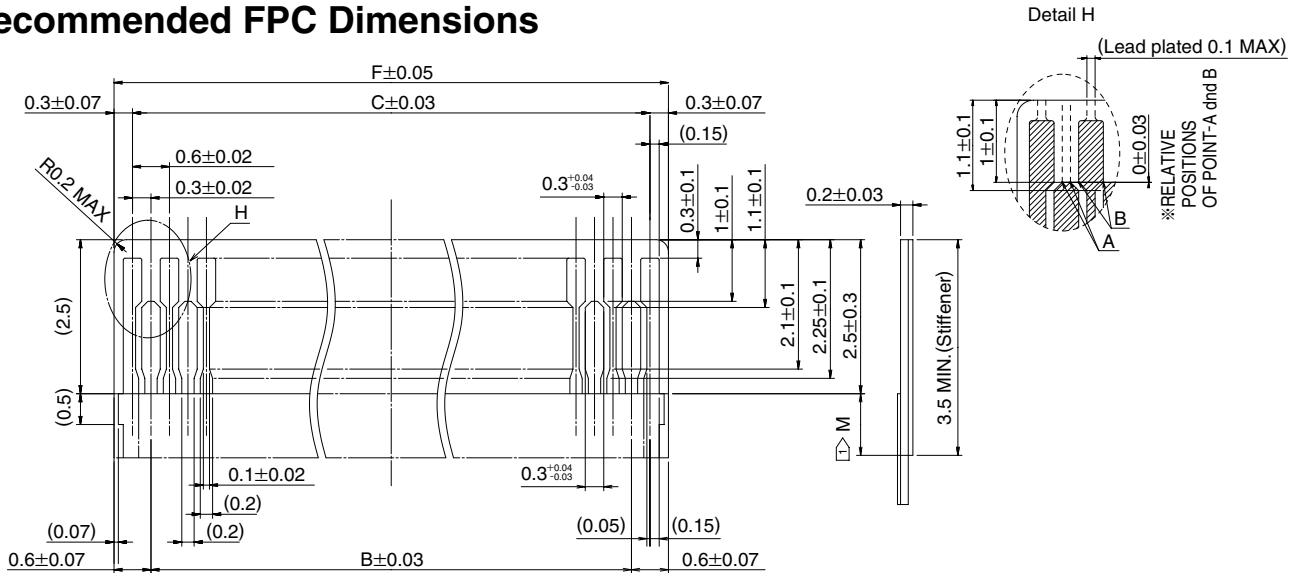

① Dimension M must be 0.5mm minimum when the stiffener is shorter than 3.5 min.

All dimensions: mm

Part Number	CL No.	Number of Contacts	B	C	F	Part Number	CL No.	Number of Contacts	B	C	F
FH26-13S-0.3SHW(**)	580-0209-3-**-	13	3.0	3.6	4.2	FH26W-13S-0.3SHW(**)	580-2401-1-**-	13	3.0	3.6	4.2
FH26-15S-0.3SHW(**)	580-0218-4-**-	15	3.6	4.2	4.8	FH26W-15S-0.3SHW(**)	580-2402-4-**-	15	3.6	4.2	4.8
FH26-17S-0.3SHW(**)	580-0217-1-**-	17	4.2	4.8	5.4	FH26W-17S-0.3SHW(**)	580-2403-7-**-	17	4.2	4.8	5.4
FH26-21S-0.3SHW(**)	580-0207-8-**-	21	5.4	6.0	6.6	FH26W-19S-0.3SHW(**)	580-2437-9-**-	19	4.8	5.4	6.0
FH26-23S-0.3SHW(**)	580-0203-7-**-	23	6.0	6.6	7.2	FH26W-21S-0.3SHW(**)	580-2404-0-**-	21	5.4	6.0	6.6
FH26-25S-0.3SHW(**)	580-0208-0-**-	25	6.6	7.2	7.8	FH26W-23S-0.3SHW(**)	580-2405-2-**-	23	6.0	6.6	7.2
FH26-27S-0.3SHW(**)	580-0204-0-**-	27	7.2	7.8	8.4	FH26W-25S-0.3SHW(**)	580-2406-5-**-	25	6.6	7.2	7.8
FH26-29S-0.3SHW(**)	580-0216-9-**-	29	7.8	8.4	9.0	FH26W-27S-0.3SHW(**)	580-2400-9-**-	27	7.2	7.8	8.4
FH26-31S-0.3SHW(**)	580-0214-3-**-	31	8.4	9.0	9.6	FH26W-29S-0.3SHW(**)	580-2407-8-**-	29	7.8	8.4	9.0
FH26-33S-0.3SHW(**)	580-0210-2-**-	33	9.0	9.6	10.2	FH26W-31S-0.3SHW(**)	580-2408-0-**-	31	8.4	9.0	9.6
FH26-35S-0.3SHW(**)	580-0205-2-**-	35	9.6	10.2	10.8	FH26W-33S-0.3SHW(**)	580-2409-3-**-	33	9.0	9.6	10.2
FH26-37S-0.3SHW(**)	580-0224-7-**-	37	10.2	10.8	11.4	FH26W-35S-0.3SHW(**)	580-2410-2-**-	35	9.6	10.2	10.8
FH26-39S-0.3SHW(**)	580-0201-1-**-	39	10.8	11.4	12.0	FH26W-37S-0.3SHW(**)	580-2411-5-**-	37	10.2	10.8	11.4
FH26-41S-0.3SHW(**)	580-0206-5-**-	41	11.4	12.0	12.6	FH26W-39S-0.3SHW(**)	580-2412-8-**-	39	10.8	11.4	12.0
FH26-45S-0.3SHW(**)	580-0211-5-**-	45	12.6	13.2	13.8	FH26W-41S-0.3SHW(**)	580-2413-0-**-	41	11.4	12.0	12.6
FH26-51S-0.3SHW(**)	580-0200-9-**-	51	14.4	15.0	15.6	FH26W-45S-0.3SHW(**)	580-2414-3-**-	45	12.6	13.2	13.8
FH26-55S-0.3SHW(**)	580-0221-9-**-	55	15.6	16.2	16.8	FH26W-51S-0.3SHW(**)	580-2415-6-**-	51	14.4	15.0	15.6
FH26-57S-0.3SHW(**)	580-0212-8-**-	57	16.2	16.8	17.4	FH26W-57S-0.3SHW(**)	580-2417-1-**-	57	16.2	16.8	17.4
FH26-61S-0.3SHW(**)	580-0213-0-**-	61	17.4	18.0	18.6	FH26W-61S-0.3SHW(**)	580-2418-4-**-	61	17.4	18.0	18.6
FH26-71S-0.3SHW(**)	580-0202-4-**-	71	20.4	21.0	21.6	FH26W-71S-0.3SHW(**)	580-2419-7-**-	71	20.4	21.0	21.6

Recommended FPC Construction

Contact FPC manufacturer for specific details.

1. Using Single-sided FPC

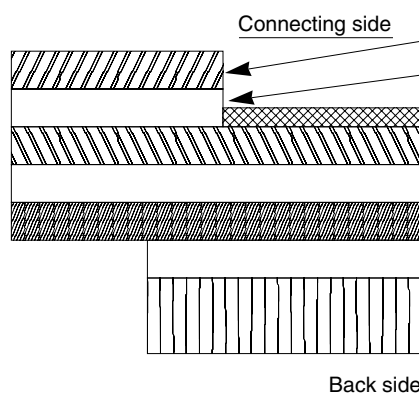

Material Name	Material	Thickness (μm)
Covering film layer.	Polyimide 1 mil thick.	25
Cover adhesive		25
Surface treatment	1 μm to 5 μm Nickel underplated 0.2 μm Gold plated	3
Copper foil	Cu 1/2oz	35
Base adhesive	Thermosetting adhesive	25
Base film	Polyimide 1 mil thick	25
Reinforcement material adhesive	Thermosetting adhesive	40
Stiffener	Polyimide 3 mil thick	75
	Total	203

2. Using Double-sided FPC

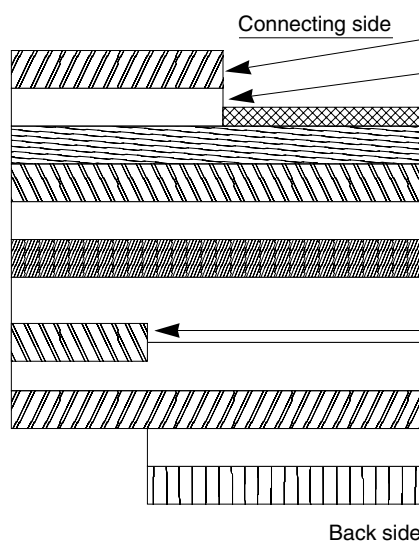

Material Name	Material	Thickness (μm)
Covering layer film	Polyimide 1 mil thick	25
Cover adhesive		25
Surface treatment	1 μm to 5 μm Nickel underplated 0.2 μm Gold plated	3
Through-hole copper	Cu	15
Copper foil	Cu 1/2oz	18
Base adhesive	Thermosetting adhesive	18
Base film	Polyimide 1 mil thick	25
Base adhesive	Thermosetting adhesive	18
Copper foil	Cu 1/2oz	18
Cover adhesive	Thermosetting adhesive	25
Covering layer film	Polyimide 1 mil thick	25
Reinforcement material adhesive	Thermosetting adhesive	25
Stiffener	Polyimide 1 mil thick	25
	Total	197

To prevent release of the FPC due to its bending, use of double sided FPC with copper foil on the back side is NOT RECOMMENDED.

3. Precautions

1. This specification is a recommendation for the construction of the FH26 Series FPC and FFC ($t=0.2 \pm 0.03$).
2. For details about the construction, please contact the FPC/FFC manufacturers.

■ Packaging Specification

● Embossed Carrier Tape Dimensions (Tape width of 24mm max.)

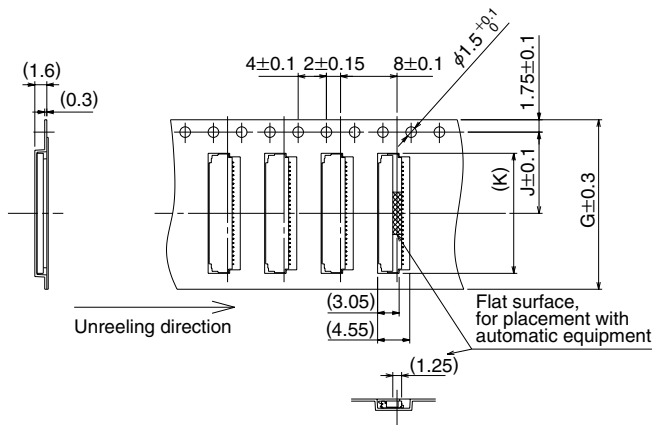

● Embossed Carrier Tape Dimensions (Tape width of 32mm min.)

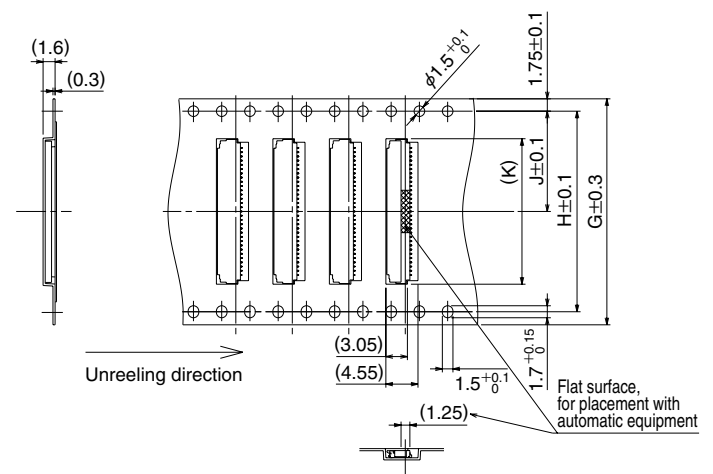

● Reel Dimensions

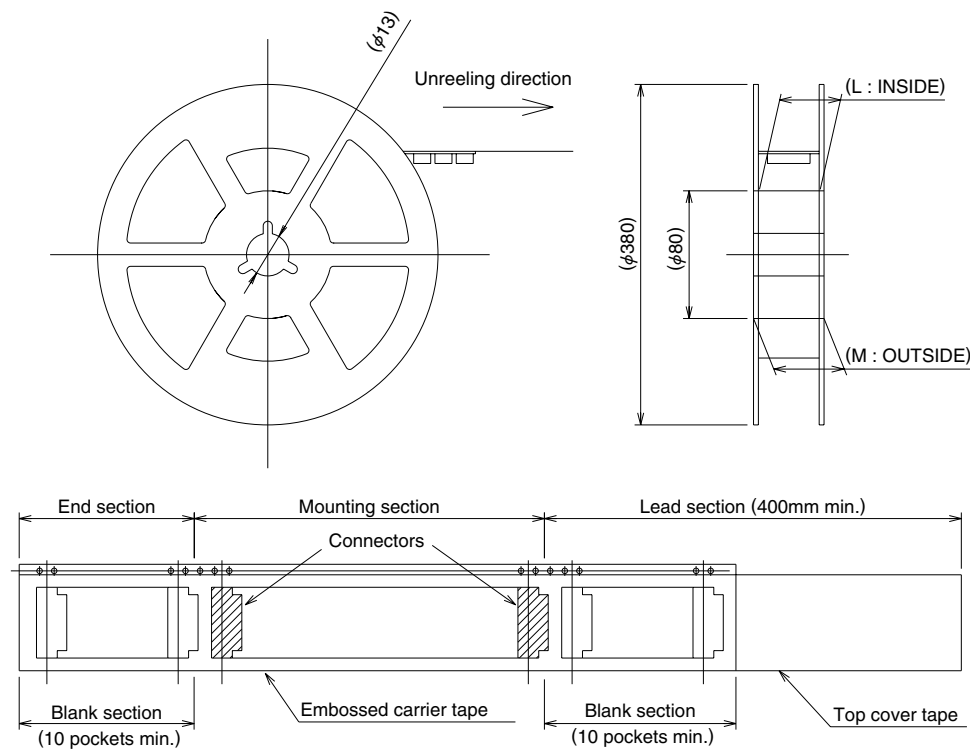

All dimensions: mm

Part Number	CL No.	Number of Contacts	G	H	J	K	L	M
FH26-13S-0.3SHW(**)	580-0209-3-**-	13	16	—	7.5	5.6	17.4	21.4
FH26-15S-0.3SHW(**)	580-0218-4-**-	15	16	—	7.5	6.2	17.4	21.4
FH26-17S-0.3SHW(**)	580-0217-1-**-	17	16	—	7.5	6.8	17.4	21.4
FH26-21S-0.3SHW(**)	580-0207-8-**-	21	16	—	7.5	8.0	17.4	21.4
FH26-23S-0.3SHW(**)	580-0203-7-**-	23	16	—	7.5	8.6	17.4	21.4
FH26-25S-0.3SHW(**)	580-0208-0-**-	25	16	—	7.5	9.2	17.4	21.4
FH26-27S-0.3SHW(**)	580-0204-0-**-	27	16	—	7.5	9.8	17.4	21.4
FH26-29S-0.3SHW(**)	580-0216-9-**-	29	24	—	11.5	10.4	25.4	29.4
FH26-31S-0.3SHW(**)	580-0214-3-**-	31	24	—	11.5	11.0	25.4	29.4
FH26-33S-0.3SHW(**)	580-0210-2-**-	33	24	—	11.5	11.6	25.4	29.4
FH26-35S-0.3SHW(**)	580-0205-2-**-	35	24	—	11.5	12.2	25.4	29.4
FH26-37S-0.3SHW(**)	580-0224-7-**-	37	24	—	11.5	12.8	25.4	29.4
FH26-39S-0.3SHW(**)	580-0201-1-**-	39	24	—	11.5	13.4	25.4	29.4
FH26-41S-0.3SHW(**)	580-0206-5-**-	41	24	—	11.5	14.0	25.4	29.4
FH26-45S-0.3SHW(**)	580-0211-5-**-	45	24	—	11.5	15.2	25.4	29.4
FH26-51S-0.3SHW(**)	580-0200-9-**-	51	24	—	11.5	17.0	25.4	29.4
FH26-55S-0.3SHW(**)	580-0221-9-**-	55	32	28.4	14.2	18.2	33.4	37.4
FH26-57S-0.3SHW(**)	580-0212-8-**-	57	32	28.4	14.2	18.8	33.4	37.4
FH26-61S-0.3SHW(**)	580-0213-0-**-	61	32	28.4	14.2	20.0	33.4	37.4
FH26-71S-0.3SHW(**)	580-0202-4-**-	71	44	40.4	20.2	23.0	45.4	49.4

Part Number	CL No.	Number of Contacts	G	H	J	K	L	M
FH26W-13S-0.3SHW(**)	580-2401-1-**-	13	16	—	7.5	5.6	17.4	21.4
FH26W-15S-0.3SHW(**)	580-2402-4-**-	15	16	—	7.5	6.2	17.4	21.4
FH26W-17S-0.3SHW(**)	580-2403-7-**-	17	16	—	7.5	6.8	17.4	21.4
FH26W-19S-0.3SHW(**)	580-2437-9-**-	19	16	—	7.5	7.4	17.4	21.4
FH26W-21S-0.3SHW(**)	580-2404-0-**-	21	16	—	7.5	8.0	17.4	21.4
FH26W-23S-0.3SHW(**)	580-2405-2-**-	23	16	—	7.5	8.6	17.4	21.4
FH26W-25S-0.3SHW(**)	580-2406-5-**-	25	16	—	7.5	9.2	17.4	21.4
FH26W-27S-0.3SHW(**)	580-2400-9-**-	27	16	—	7.5	9.8	17.4	21.4
FH26W-29S-0.3SHW(**)	580-2407-8-**-	29	24	—	11.5	10.4	25.4	29.4
FH26W-31S-0.3SHW(**)	580-2408-0-**-	31	24	—	11.5	11.0	25.4	29.4
FH26W-33S-0.3SHW(**)	580-2409-3-**-	33	24	—	11.5	11.6	25.4	29.4
FH26W-35S-0.3SHW(**)	580-2410-2-**-	35	24	—	11.5	12.2	25.4	29.4
FH26W-37S-0.3SHW(**)	580-2411-5-**-	37	24	—	11.5	12.8	25.4	29.4
FH26W-39S-0.3SHW(**)	580-2412-8-**-	39	24	—	11.5	13.4	25.4	29.4
FH26W-41S-0.3SHW(**)	580-2413-0-**-	41	24	—	11.5	14.0	25.4	29.4
FH26W-45S-0.3SHW(**)	580-2414-3-**-	45	24	—	11.5	15.2	25.4	29.4
FH26W-51S-0.3SHW(**)	580-2415-6-**-	51	24	—	11.5	17.0	25.4	29.4
FH26W-57S-0.3SHW(**)	580-2417-1-**-	57	32	28.4	14.2	18.8	33.4	37.4
FH26W-61S-0.3SHW(**)	580-2418-4-**-	61	32	28.4	14.2	20.0	33.4	37.4
FH26W-71S-0.3SHW(**)	580-2419-7-**-	71	44	40.4	20.2	23.0	45.4	49.4

Recommended Temperature Profile

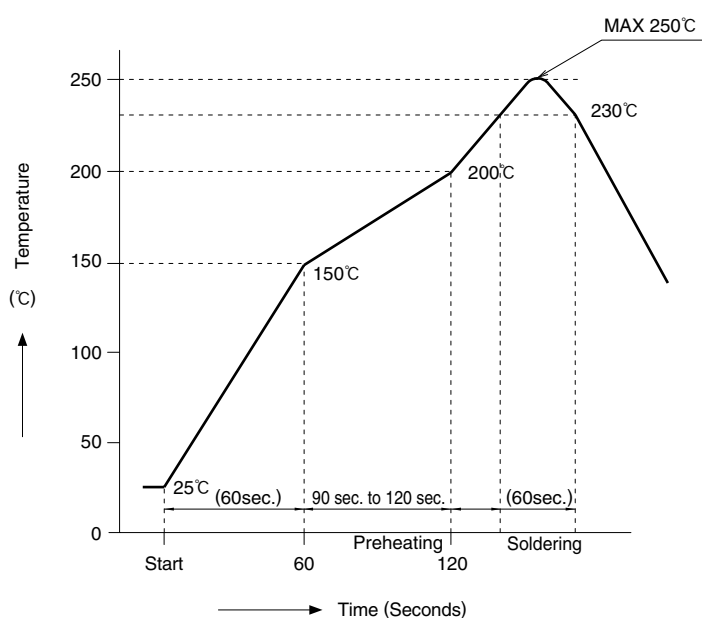

HRS test conditions

Solder method :Reflow, IR/hot air
 Environment :Room air
 Solder composition :Paste, 96.5%Sn/3.0%Ag/0.5%Cu
 (Senju Metal Industry, Co., Ltd.'s
 Part Number: M705-221CM5-32-10.5)
 Test board :Glass epoxy 25mm×50mm×0.8mm thick
 Land dimensions :0.3mm×0.65mm, 0.3mm×0.8mm
 Metal mask :0.23×0.55×0.1mm thick,
 0.23×0.65×0.1mm thick

The temperature profiles are based on the above conditions. In individual applications the actual temperature may vary, depending on solder paste type, volume/thickness and board size/thickness. Consult your solder paste and equipment manufacturer for specific recommendations.

■ Operation and Precautions

Operation

1. FPC insertion procedure. Connector installed on the board.

- ① Lift up the actuator. Use thumb or index finger.

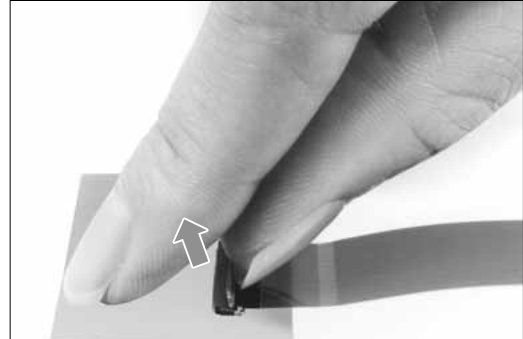

- ② Fully insert the FPC in the connector parallel to mounting surface, with the exposed conductive traces facing down.

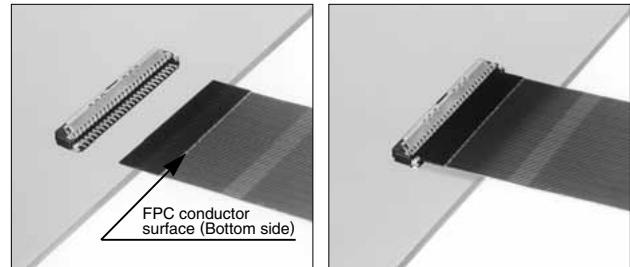

- ③ Rotate down the actuator until firmly closed. It is critical that the inserted FPC is not moved and remains fully inserted.

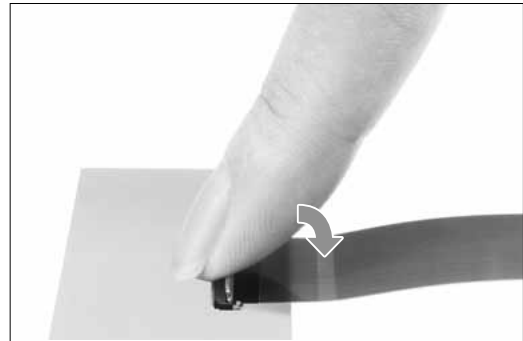

2. FPC removal

- ① Lift up the actuator. Carefully withdraw the FPC.

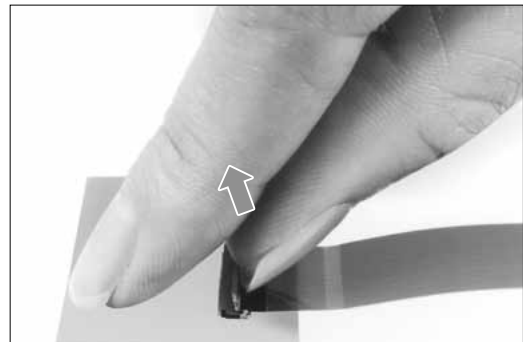

Precautions

Exercise care when handling connectors. Follow recommendations given below.

PC board flexing

◆ PC board connector mounting area

The connectors are straight within 0.1 mm max.

Make sure that the PC board connector mounting area flatness can accept the connector terminals without causing any failure of the solder joints.

◆ Handling before mounting on PCB

Insertion of the FPC or operation of the actuator prior to mounting on the PCB is NOT RECOMMENDED.

◆ PC Board handling

Exercise caution when handling boards with the connectors installed. Do not apply any forces affecting soldered joints.

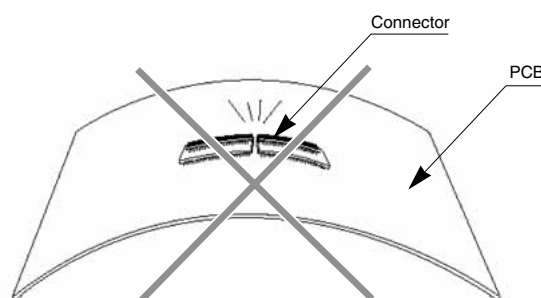

Precautions When Inserting or Coupling FPC

Pay attention to the following points when inserting FPC.

◆ Actuator operation

① Do not apply excessive force when opening the actuator prior to FPC insertion. When opening make sure that the force is applied only to the actuator itself, avoiding touching of the contacts.

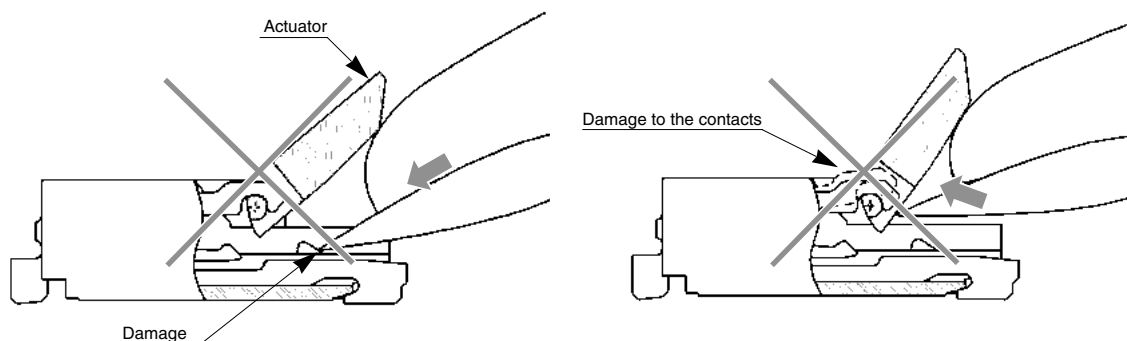

② Axis of rotation

Assure free rotation of the actuator

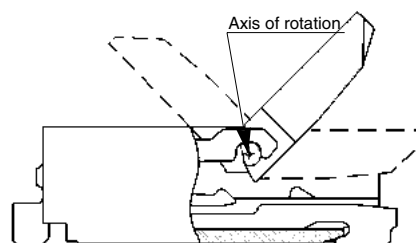

Precautions

- ③ The actuator will rotate 135 degrees maximum. Do not apply force to rotate further. (1N max.)

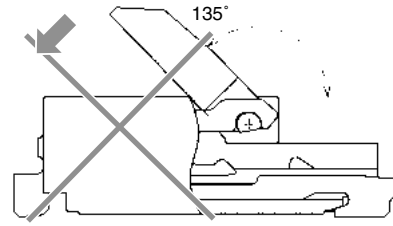

- ④ When operating the actuator, do so at the center portion.

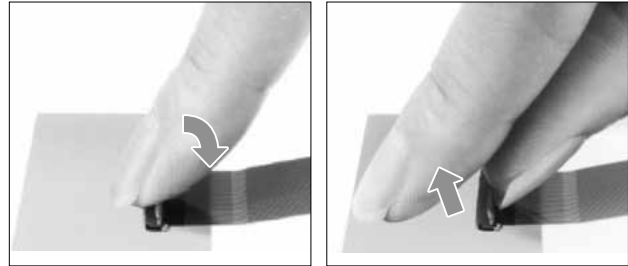

- ⑤ As illustrated, do not attempt removal or repositioning of the actuator.

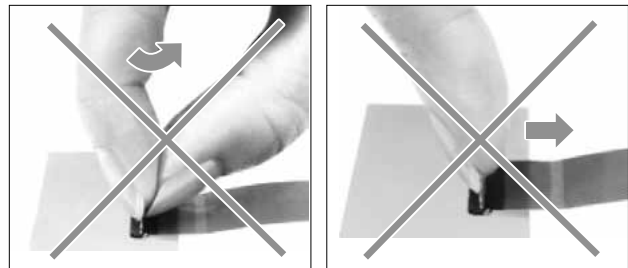

◆ FPC Insertion①

The FPC should be aligned parallel with the board surface and perpendicular with the connector (as shown), then completely inserted.

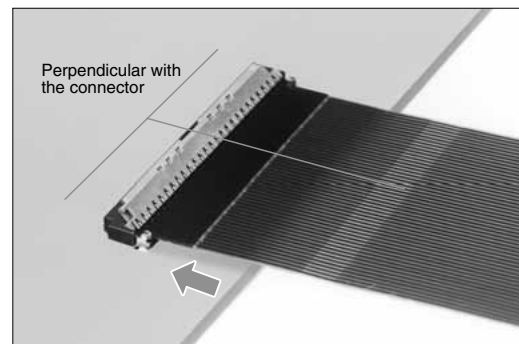
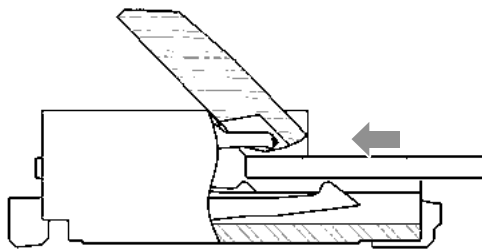

To assure correct electrical and mechanical connection do not insert FPC at angle. It must be fully inserted.

Make sure that the FPC is NOT MOVED during the closing of the actuator.

Precautions

◆ FPC Insertion②

Do not insert the FPC at any angle from above.

As illustrated, angle insertion may cause electrical discontinuity when the FPC is deflected in use.

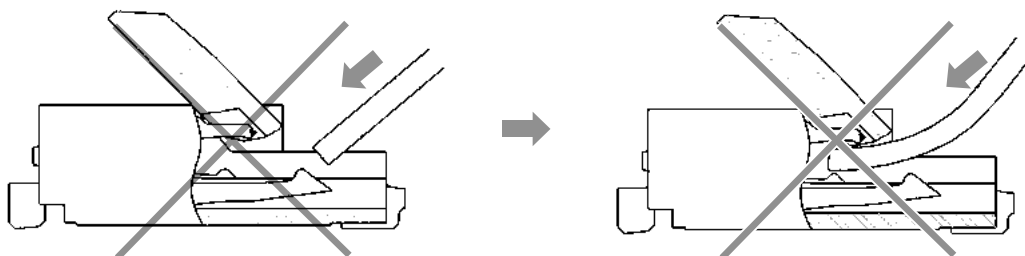

*To avert insertion of the FPC on an angle, consideration should be given to securing FPC insertion space at the time of board layout. Insertion will be difficult when the FPC is too short.

*Contact the FPC manufacturer for information about the bending specifications.

◆ Verification of the fully closed actuator.

The actuator should be fully closed (as illustrated) and the FPC held firmly in the connector.

Do not press against the actuator when it is fully closed. Max force applied to the fully closed actuator should not exceed 1 N.

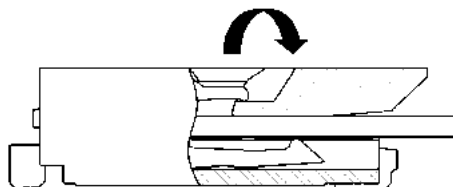

Routing the FPC (FPC fully inserted/ actuator closed)

◆ FPC Load

Do not apply force in excess of 0.05N/pin max. in the upward direction (as illustrated). Do not bend the FPC too close to the actuator.

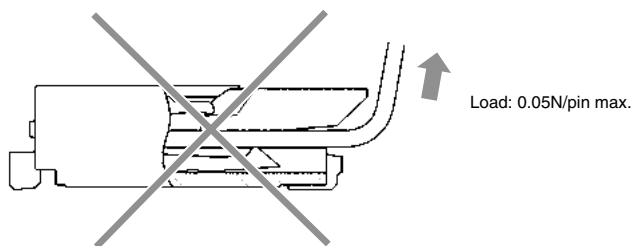

Precautions

Removing the FPC

Rotate the actuator to the open position (maximum open angle of 135°). Carefully withdraw the FPC.

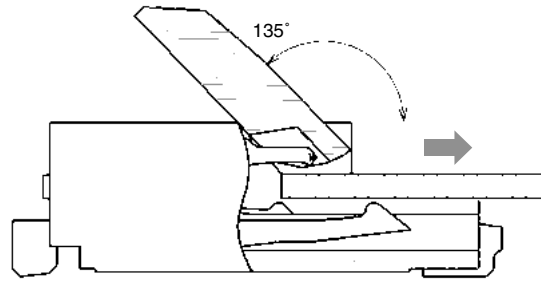
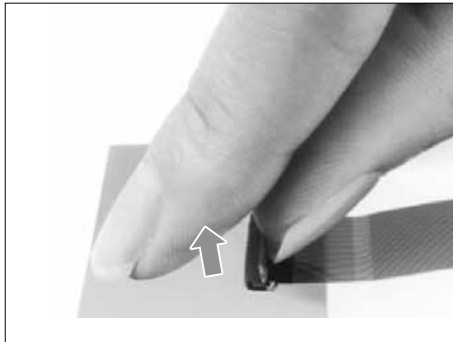

Other Precautions

◆ Hand Soldering Precautions

When hand soldering:

- ① Do not perform reflow or hand soldering with the FPC inserted in the connector.
- ② Do not apply excessive heat or touch the soldering iron anywhere other than the connector leads.
- ③ Do not use excessive amount of solder or flux compounds.

Operation of the actuator and contacts may be affected by excessive amounts of solder or flux compounds.

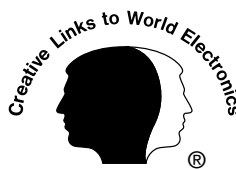

HRS

HIROSE ELECTRIC CO.,LTD.

5-23,OSAKI 5-CHOME,SHINAGAWA-KU,TOKYO 141-8587,JAPAN



PHONE: 81-3-3491-5300, FAX: 81-3-3495-5230

<http://www.hirose.com>







<http://www.hirose-connectors.com>

Looking for pricing, stock, or lifecycle information?

Click below to explore more details on WIN SOURCE:

-  [View FH26-27S-0.3SHW\(98\) on WIN SOURCE](#)
-  [Hirose Electric Co Ltd Information](#)

Optimize Your Supply Chain with WIN SOURCE Solutions

-  Global Sourcing Solution
-  Obsolete Management
-  Cost Control Management
-  Shortage Management
-  Alternative Solution
-  Excess Inventory Management