



# THE DATASHEET OF XSAV11373



# XSAV11373

Inductive proximity sensors XS, Rotation monitoring, M30, Sn10mm, 6...150c/mn, 12...48 VDC, cable 2 m



## Main

Range of Product	Telemecanique Inductive proximity sensors XS
Series name	Application
Product or Component Type	Sensor
Sensor Type	Inductive proximity sensor
Device Application	Rotation monitoring
Sensor name	XSA
Sensor design	Cylindrical M30
Size	81 mm
Body type	Fixed
Detector flush mounting acceptance	Flush mountable
Material	Metal
Enclosure Material	Nickel Plated Brass
Type of output signal	Discrete
Wiring Technique	3-wire
[Sn] nominal sensing distance	0.39 in (10 mm)
Discrete output function	1 NC
Output circuit type	DC
Discrete output type	PNP
Electrical connection	Cable
Cable length	6.56 ft (2 m)
[Us] rated supply voltage	12...48 V DC reverse polarity protection
Switching capacity in mA	<= 200 mA overload and short-circuit protection
IP degree of protection	IP67 conforming to IEC 60529

## Complementary

Thread type	M30 x 1.5
Detection face	Frontal
Front material	PPS
Sensing range	> 0.31...0.59 in (> 8...15 mm)
Adjustable frequency range	6...150 cyc/mn
Operating zone	0.00...0.31 in (0...8 mm)
Differential travel	3...15% of Fr
Repeat accuracy	3% of Sr
Cable composition	3 x 0.34 mm <sup>2</sup>
Wire insulation material	PvR
Status LED	Output state 1 LED red)
Supply voltage limits	10...58 V DC
Switching frequency	<= 100 Hz
Maximum voltage drop	<1.8 V closed)
Current consumption	0...15 mA no-load
Run-up delay at power-up	9 s standard

The information provided in this documentation contains general descriptions and/or technical characteristics of the performance of the products contained herein. This documentation is not intended as a substitute for and is not to be used for determining suitability or reliability of these products for specific user applications. It is the duty of any such user or integrator to perform the appropriate and complete risk analysis, evaluation and testing of the products with respect to the relevant specific application or use thereof. Neither Schneider Electric Industries SAS nor any of its affiliates or subsidiaries shall be responsible or liable for misuse of the information contained herein.

Marking	CE
Threaded length	2.64 in (67 mm)
Length	3.19 in (81 mm)
Net Weight	0.66 lb(US) (0.3 kg)

## Environment

Product Certifications	CSA UL CCC
Ambient air temperature for operation	-13...158 °F (-25...70 °C)
Ambient Air Temperature for Storage	-40...185 °F (-40...85 °C)

## Ordering and shipping details

Category	22486 - SENSORS, PROXIMITY
Discount Schedule	DS2
GTIN	3389110628944
Nbr. of units in pkg.	1
Package weight(Lbs)	8.11 oz (230 g)
Returnability	Yes
Country of origin	FR

## Packing Units

Unit Type of Package 1	PCE
Package 1 Height	1.61 in (4.1 cm)
Package 1 width	3.74 in (9.5 cm)
Package 1 Length	5.20 in (13.2 cm)
Unit Type of Package 2	S02
Number of Units in Package 2	22
Package 2 Weight	11.79 lb(US) (5.35 kg)
Package 2 Height	5.91 in (15 cm)
Package 2 width	11.81 in (30 cm)
Package 2 Length	15.75 in (40 cm)

## Offer Sustainability

Sustainable offer status	Green Premium product
California proposition 65	WARNING: This product can expose you to chemicals including: Diisononyl phthalate (DINP), which is known to the State of California to cause cancer, and Di-isodecyl phthalate (DIDP), which is known to the State of California to cause birth defects or other reproductive harm. For more information go to <a href="http://www.P65Warnings.ca.gov">www.P65Warnings.ca.gov</a>
REACH Regulation	<a href="#">REACH Declaration</a>
EU RoHS Directive	Pro-active compliance (Product out of EU RoHS legal scope) <a href="#">EU RoHS Declaration</a>
Mercury free	Yes
RoHS exemption information	<a href="#">Yes</a>
Environmental Disclosure	<a href="#">Product Environmental Profile</a>
Circularity Profile	<a href="#">End Of Life Information</a>

## Contractual warranty

Warranty	18 months
----------	-----------

Dimensions

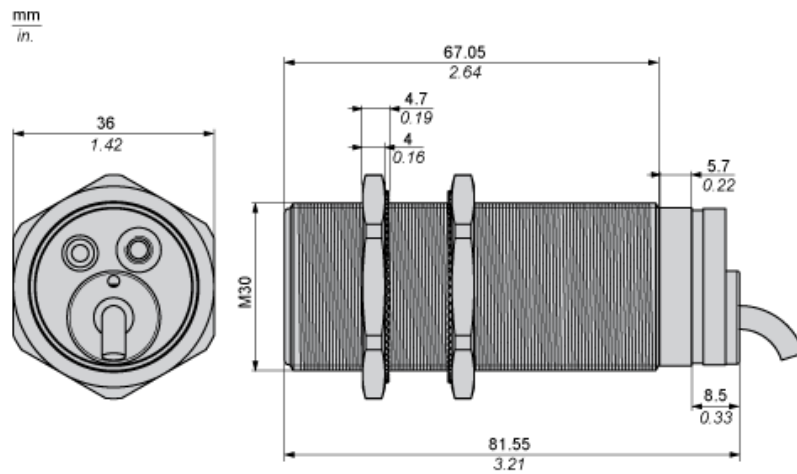

(1) LED

---

Minimum Mounting Distances

---

Side by side

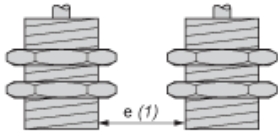

e (1) 20 mm/0.79 in

≥

Face to face

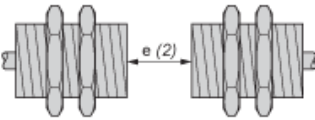

e (2) 120 mm/4.72 in

≥

Facing a metal object

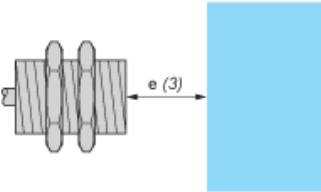

e (3) 30 mm/1.18 in.

≥

---

Wiring Schemes

---

3-wire DC

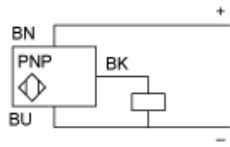

BU : Blue  
BN : Brown  
BK : Black

---

Performance Curves

---

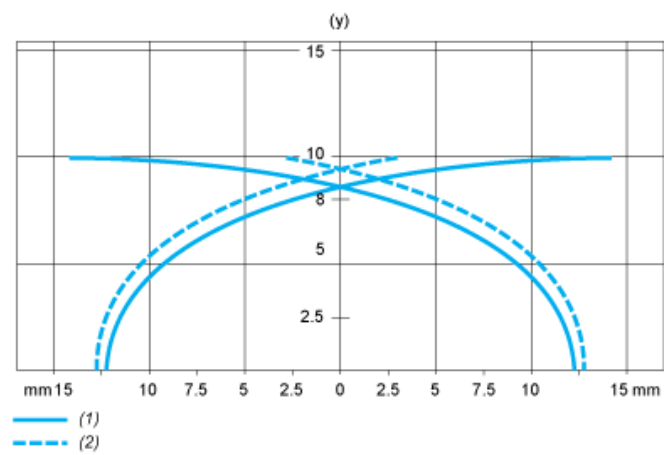

Standard Steel Target : 30x30x1 mm



- (1) Pick-up points
- (2) Drop-out points (object approaching from the side)
- (y) Sensing distance in mm

## Looking for pricing, stock, or lifecycle information?

Click below to explore more details on WIN SOURCE:

-  [View XSAV11373 on WIN SOURCE](#)
-  [Schneider Electric](#) Information

## Optimize Your Supply Chain with WIN SOURCE Solutions

-  Global Sourcing Solution
-  Obsolete Management
-  Cost Control Management
-  Shortage Management
-  Alternative Solution
-  Excess Inventory Management