



**THE DATASHEET OF
ECC-T3G100DG2**



High Voltage Ceramic Capacitors For Surface Mounting 1 to 5 kVDC



■ Features

- Resin molded SMD type for reflow solderings
- High reliability through use of disc capacitor element
- Wide rated voltage ranges from 1 kV to 5 kV, through a disc element which withstand high voltage and outcurve terminals
- Wide rated voltage range 1 to 5 kV

■ Recommended Application

- Ballast circuit of LCD backlighting inverter (For 3 to 5 kVDC Char.SL/GP)
- Snubber circuit of switching power supply (For 1 to 2 kVDC Char.B/Y5P)

■ Explanation of Part Numbers

| | | | | | | | | | | | | | | | | | | | | | | | |
|--------------|--------|-----------------|------------|---------------|---------------|---------------------|-------------|----------------|---------|-------------|-------------|--------|------------|---|--|---|--|----|--|----|--|----|--|
| 1 | | 2 | | 3 | | 4 | | 5 | | 6 | | 7 | | 8 | | 9 | | 10 | | 11 | | 12 | |
| E | | C | | C | | T | | 3 | | F | | 4 | | 7 | | 0 | | J | | G | | | |
| Product Code | | Packaging Style | | Rated Voltage | | Nominal Capacitance | | Cap. Tolerance | | Temp. Char. | | Suffix | | | | | | | | | | | |
| Code | Class | Code | Style | Code | Rated Voltage | Ex. | Capacitance | Code | Tol. | Code | Temp. Char. | Code | Style code | | | | | | | | | | |
| ECC | Class1 | T | Taped type | 3A | 1 kVDC | 100 | 10 pF | D | ±0.5 pF | G | SL/GP | Nil | 1 | | | | | | | | | | |
| ECK | Class2 | | | 3D | 2 kVDC | 470 | 47 pF | J | ±5 % | B | B/Y5P | M | 2 | | | | | | | | | | |
| | | | | 3F | 3 kVDC | 101 | 100 pF | K | ±10 % | | | 2 | 3 | | | | | | | | | | |
| | | | | 3G | 4 kVDC | 221 | 220 pF | M | ±20 % | | | Y | 4 | | | | | | | | | | |
| | | | | 3H | 5 kVDC | | | | | | | | | | | | | | | | | | |

■ Construction

- Inside Terminal



■ Dimensions in mm (not to scale)

- style 1, 3

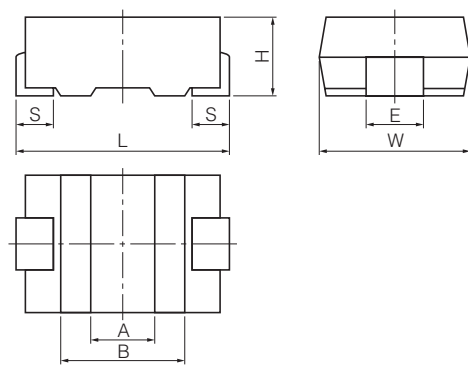

- Outside Terminal

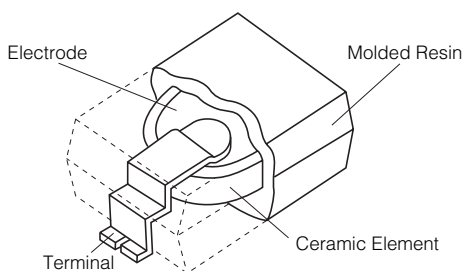

- style 2, 4

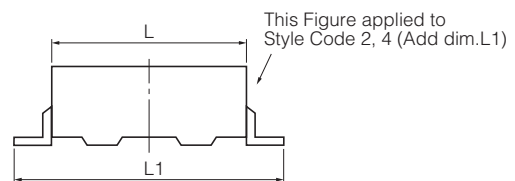

| Symbol | L1 | L | W | H | S | E | A | B |
|---------|----------|---------|---------|---------|-----------|---------|-------|-------|
| Style 1 | — | 7.1±0.5 | 6.3±0.3 | 2.5±0.3 | 1.45±0.30 | 2.5±0.2 | (2.0) | (3.7) |
| Style 2 | 10.8±0.5 | 6.8±0.5 | 6.3±0.3 | 2.5±0.3 | — | 2.5±0.2 | (2.0) | (3.7) |
| Style 3 | — | 5.7±0.5 | 4.5±0.3 | 2.3max. | 0.85±0.30 | 2.5±0.2 | (1.7) | (3.1) |
| Style 4 | 9.4±0.3 | 5.5±0.5 | 4.5±0.3 | 2.3±0.2 | — | 2.5±0.2 | (1.7) | (3.1) |

Specifications

| Characteristics | Char. SL/GP | | | Char. B/Y5P |
|---------------------------------|--|---|---|---|
| Operating Temperature Range | -25 to 105 °C | | | |
| Rated Voltage | 2 to 3 kVDC | 4 to 5 kVDC | 5 kVDC | 1 to 2 kVDC |
| Dielectric Withstanding Voltage | 200 % of Rated Voltage for 1 to 5 seconds | 150 % of Rated Voltage for 1 to 5 seconds | 120 % of Rated Voltage for 1 to 5 seconds | 200 % of Rated Voltage for 1 to 5 seconds |
| Capacitance | Within the specified tolerance, when measured at 1 MHz±20 %, 1 to 5 Vrms. and 20 °C | | | Within the specified tolerance, when measured at 1 kHz±20 %, 1 to 5 Vrms. and 20 °C |
| Q or Dissipation Factor (tan δ) | 30 pF or under Q ≥ 400+20 C (C:Cap.pF) over 30 pF Q ≥ 1000 at 1 MHz±20 %, 1 to 5 Vrms. and 20 °C | | | tan δ ≤ 0.025 at 1 kHz±20 %, 1 to 5 Vrms. and 20 °C |
| Insulation Resistance | 10000 M Ω min. at 500 VDC and 1 minute electrification | | | |
| Temperature Characteristics | Temperature Coefficient: +350 to -1000 ppm/ °C (Temperature Range : 20 to 85 °C) | | | Max. Cap. Change:±10 % (Temperature Range : -25 to 85 °C) |

Packaging Methods (Taping)

Minimum Quantity/Packing Unit

| Type | Packaging Style | Part Number | | Minimum Packing Quantity | Packing Quantity in Carton | Carton Dimensions in mm LxWxH |
|-----------------------|-------------------------|---------------|-------------|--------------------------|----------------------------|-------------------------------|
| 1 to 5 kVDC (style 1) | Embossed Carrier Taping | EC□T3□□□□□□□□ | 5 to 470 pF | 2000 pcs./reel | 6000 pcs. | 350×350×62 |
| 5 kVDC (style 2) | Embossed Carrier Taping | ECCT3H□□□□□□M | 5 to 27 pF | 2000 pcs./reel | 4000 pcs. | 350×350×62 |
| 4 kVDC (style 3) | Embossed Carrier Taping | ECCT3G□□□□JG2 | 10 to 27 pF | 3000 pcs./reel | 9000 pcs. | 350×350×62 |
| 5 kVDC (style 4) | Embossed Carrier Taping | ECCT3H□□□□□□Y | 5 to 15 pF | 3000 pcs./reel | 6000 pcs. | 350×350×62 |

Reel

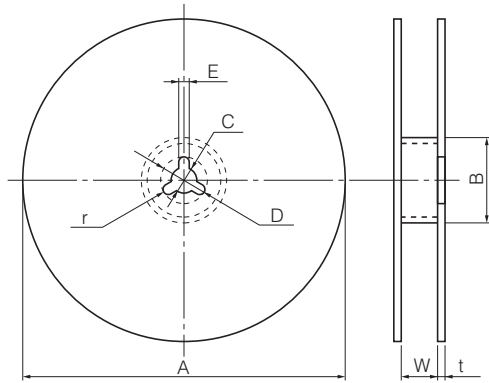

Unit:(mm)

| Symbol | A | B | C | D | E | W | t | r |
|-----------|------------|-------|---------|----------|----------|---------|----------|------|
| Dim. (mm) | style 1, 3 | 330±5 | 60 min. | 13.0±0.5 | 21.0±1.0 | 2.0±0.5 | 13.5±1.5 | R1.0 |
| | style 2 | | | | | | 25.5±1.5 | |
| | style 4 | | | | | | 17.5±1.5 | |

Embossed Carrier Taping

style 1, 3, 4

(W=12 mm)

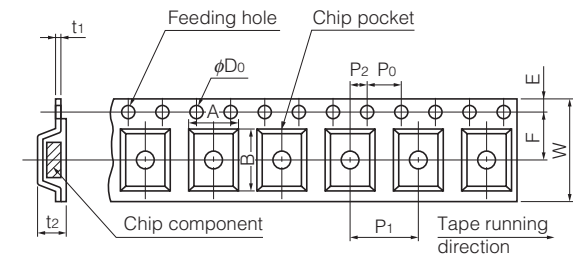

style 2

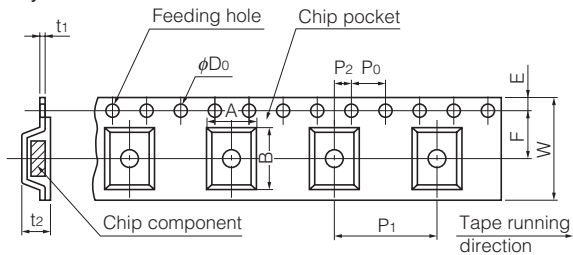

Unit:(mm)

| Symbol | A | B | W | F | E | P1 | P2 | P0 | φD0 | t1 | t2 | |
|-----------|--------|----------|------------|-----------|-----------|------------|------------|-----------|----------|-------------|-------------|----------|
| Dim. (mm) | style1 | 6.5 ±0.2 | 7.5 ±0.2 | 12.0 ±0.3 | 5.5 ±0.1 | 1.75 ±0.10 | 8.0 ±0.1 | 2.0 ±0.1 | 4.0 ±0.1 | 1.5 +0.1 -0 | 0.3 ±0.1 | 3.2 ±0.3 |
| | | style2 | 6.65 ±0.20 | 11.2 ±0.2 | 24.0 ±0.3 | 11.5 ±0.1 | 1.75 ±0.10 | 12.0 ±0.1 | 2.0 ±0.1 | 4.0 ±0.1 | 1.5 +0.1 -0 | 0.3 ±0.1 |
| | style3 | 4.8 ±0.2 | 6.0 ±0.2 | 12.0 ±0.3 | 5.5 ±0.1 | 1.75 ±0.10 | 8.0 ±0.1 | 2.0 ±0.1 | 4.0 ±0.1 | 1.5 +0.1 -0 | 0.3 ±0.1 | 2.8 ±0.3 |
| | | style4 | 4.7 ±0.2 | 10.0 ±0.5 | 16.0 ±0.3 | 7.5 ±0.1 | 1.75 ±0.10 | 8.0 ±0.1 | 2.0 ±0.1 | 4.0 ±0.1 | 1.5 +0.1 -0 | 0.3 ±0.1 |

● Leader Part and Taped End



■ Ratings and Characteristics

● Rated Voltage 1 to 5 kVDC

| Rated Voltage | Part Number | Capacitance (pF) | Cap. Tolerance (%) | Temp. Char | Style |
|---------------|--------------|------------------|--------------------|------------|---------|
| 5 kVDC | ECCT3H050DGM | 5 | ±0.5 pF | SL/GP | Style 2 |
| | ECCT3H100JGM | 10 | ±5 | SL/GP | |
| | ECCT3H120JGM | 12 | ±5 | SL/GP | |
| | ECCT3H150JGM | 15 | ±5 | SL/GP | |
| | ECCT3H180JGM | 18 | ±5 | SL/GP | |
| | ECCT3H220JGM | 22 | ±5 | SL/GP | |
| | ECCT3H270JGM | 27 | ±5 | SL/GP | Style 4 |
| | ECCT3H050DGY | 5 | ±0.5 pF | SL/GP | |
| | ECCT3H080DGY | 8 | ±0.5 pF | SL/GP | |
| | ECCT3H100JGY | 10 | ±5 | SL/GP | |
| | ECCT3H120JGY | 12 | ±5 | SL/GP | |
| | ECCT3H150JGY | 15 | ±5 | SL/GP | |
| 4 kVDC | ECCT3G100DG2 | 10 | ±0.5 pF | SL/GP | Style 3 |
| | ECCT3G120JG2 | 12 | ±5 | SL/GP | |
| | ECCT3G150JG2 | 15 | ±5 | SL/GP | |
| | ECCT3G180JG2 | 18 | ±5 | SL/GP | |
| | ECCT3G220JG2 | 22 | ±5 | SL/GP | |
| | ECCT3G270JG2 | 27 | ±5 | SL/GP | |
| | ECCT3G330JG | 33 | ±5 | SL/GP | Style 1 |
| | ECCT3G390JG | 39 | ±5 | SL/GP | |
| | ECCT3G470JG | 47 | ±5 | SL/GP | |
| | ECCT3F100DG2 | 10 | ±0.5 pF | SL/GP | |
| ECCT3F120JG2 | 12 | ±5 | SL/GP | | |
| ECCT3F150JG2 | 15 | ±5 | SL/GP | | |
| ECCT3F180JG2 | 18 | ±5 | SL/GP | | |
| ECCT3F220JG2 | 22 | ±5 | SL/GP | | |
| ECCT3F270JG2 | 27 | ±5 | SL/GP | | |
| ECCT3F330JG2 | 33 | ±5 | SL/GP | | |
| ECCT3F390JG | 39 | ±5 | SL/GP | | |
| 2 kVDC | ECCT3F470JG | 47 | ±5 | SL/GP | Style 1 |
| | ECCT3F560JG | 56 | ±5 | SL/GP | |
| | ECCT3D680JG | 68 | ±5 | SL/GP | |
| | ECKT3D101KB | 100 | ±10 | B/Y5P | |
| | ECKT3D121KB | 120 | ±10 | B/Y5P | |
| | ECKT3D151KB | 150 | ±10 | B/Y5P | |
| | ECKT3D181KB | 180 | ±10 | B/Y5P | |
| | ECKT3D221KB | 220 | ±10 | B/Y5P | |
| 1 kVDC | ECKT3D271KB | 270 | ±10 | B/Y5P | Style 1 |
| | ECKT3D331KB | 330 | ±10 | B/Y5P | |
| 1 kVDC | ECKT3A391KB | 390 | ±10 | B/Y5P | Style 1 |
| | ECKT3A471KB | 470 | ±10 | B/Y5P | |

Notes * This part number indicates taped type.
 * Capacitance 9 pF or under is available by special order.

Design and specifications are each subject to change without notice. Ask factory for the current technical specifications before purchase and/or use.
 Should a safety concern arise regarding this product, please be sure to contact us immediately.

■ Typical Characteristics

● Temperature Characteristics

Char. SL/GP
(Temp.Coeff.:+350 to -1000 ppm/°C)



Char. B/Y5P
(Temp.Range:-25 to 85 °C)
(max.Cap.Change:±10 %)

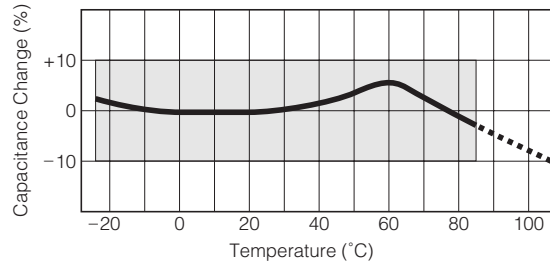

● Characteristics of Voltage-Frequency

Rated Voltage 3 kVDC

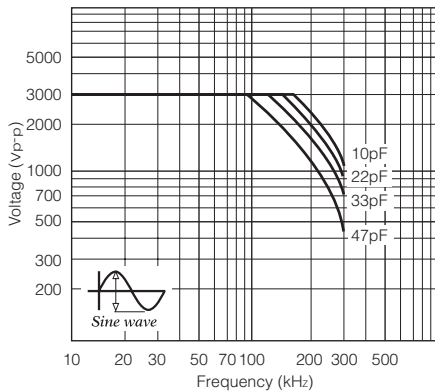

Rated Voltage 4 kVDC

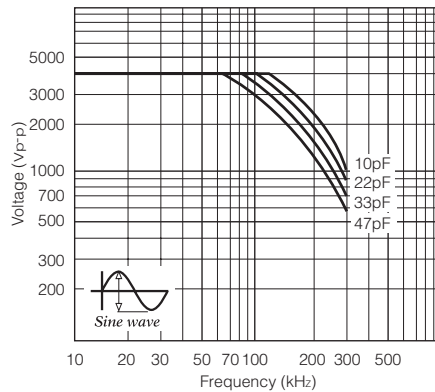

Rated Voltage 5 kVDC

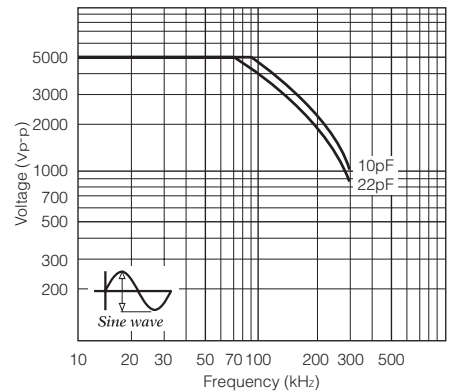

The graphs above show the maximum permissible voltage when using a capacitor with an AC sine wave voltage.

When measuring this voltage in room temperature (25 °C), the capacitor self-heat generation will rise a maximum of 20 °C.

When using a pulse voltage or an AC voltage other than a sine wave, confirm that the capacitor self-heat generation is less than 20 °C in an ambient room temperature of 25 °C.

The self-heat generation temperature is the difference between the surface temperature and the ambient room temperature.

As for the situation when the self-heat generation temperature is more than 25 °C, refer to the figure on the right.

Permission self generation of heat temperature vs. ambient temperature

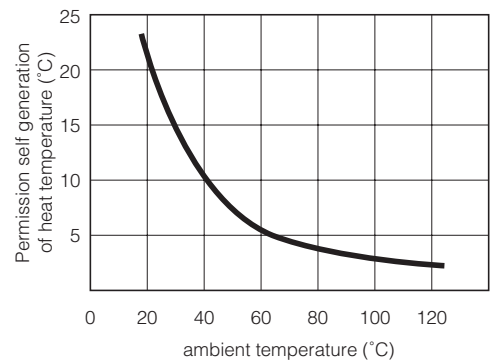

■ Application Examples

● LCD Backlighting Inverter



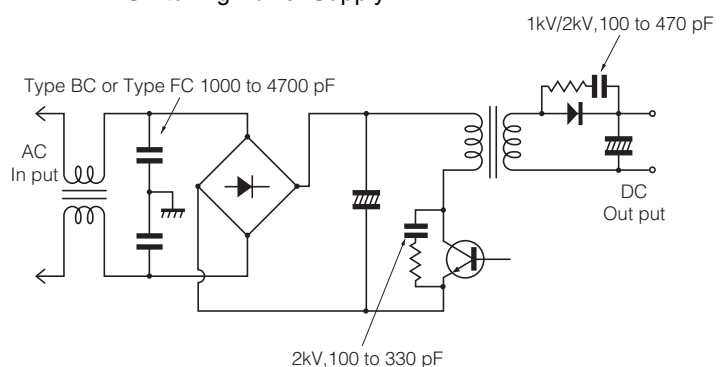

● Primary circuit and Snubber circuit of Switching Power Supply



Looking for pricing, stock, or lifecycle information?

Click below to explore more details on WIN SOURCE:

-  [View ECC-T3G100DG2 on WIN SOURCE](#)
-  [Panasonic Information](#)

Optimize Your Supply Chain with WIN SOURCE Solutions

-  Global Sourcing Solution
-  Obsolete Management
-  Cost Control Management
-  Shortage Management
-  Alternative Solution
-  Excess Inventory Management