



Printed Circuit Mount

# ST / DST Series

Split/Tran™  
Specialty Purpose & Class 2 Transformers

## Split Bobbin with High Isolation

Signal's ST and DST transformers utilize a dual cavity platform providing superior isolation and low capacitive coupling. Rigid pin construction for easier board insertion and higher reliability.

### General Specifications

- Power - 1.1 VA to 36 VA
- Dielectric Strength - 2500 Vrms Hipot
- Primaries - Single or dual primaries, 115 V or 115/230 V, 50/60 Hz
- Secondaries - Series or parallel
- Electrostatic Shield - Not necessary, split bobbin construction
- Insulation System - Class F, 155° C
- Mounting Hardware - see chart



### Agency Certifications

- UL 1446 Class F insulation systems, File # E66312
- UL Recognized 506 / UL 5085-1, 2, File # E63829
- CSA certified to C22.2 #66.1, File # 221070
- cCSAus certified to C22.2 #66.3 / UL 5085-3, File #221070
- Class 2 - marked with (\*) or (\*\*) or (#)

\*\* CSA certified as Inherently Limited

\* CSA certified as Non Inherently Limited - see recommended fuse rating table.

# UL Recognized UL5085-3, Inherently Limited File # E116583

## Part Number Selection

Part Number		Secondary RMS Rating	
Single 115 V 6 Pin	Dual 115/230 V 8 Pin	Series	Parallel
ST-2-10**#	DST-2-10**#	10 VCT @ 0.11 A	5 V @ 0.22 A
ST-3-10*#	DST-3-10*#	10 VCT @ 0.25 A (5)	5 V @ 0.5 A (9)
ST-4-10*#	DST-4-10*#	10 VCT @ 0.6 A (9)	5 V @ 1.2 A (11)
ST-5-10*#	DST-5-10*#	10 VCT @ 1.2 A (11)	5 V @ 2.4 A (13)
ST-6-10	DST-6-10	10 VCT @ 2.0 A	5 V @ 4.0 A
ST-7-10	DST-7-10	10 VCT @ 3.6 A	5 V @ 7.2 A
ST-2-12**#	DST-2-12**#	12.6 VCT @ 0.09 A	6.3 V @ 0.18 A
ST-3-12*#	DST-3-12*#	12.6 VCT @ 0.2 A (4)	6.3 V @ 0.4 A (8)
ST-4-12*#	DST-4-12*#	12.6 VCT @ 0.5 A (9)	6.3 V @ 1.0 A (11)
ST-5-12*#	DST-5-12*#	12.6 VCT @ 1.0 A (11)	6.3 V @ 2.0 A (13)
ST-6-12	DST-6-12	12.6 VCT @ 1.6 A	6.3 V @ 3.2 A
ST-7-12	DST-7-12	12.6 VCT @ 2.85 A	6.3 V @ 5.7 A
ST-2-16**#	DST-2-16**#	16 VCT @ 0.07 A	8 V @ 0.14 A
ST-3-16*#	DST-3-16*#	16 VCT @ 0.15 A (3)	8 V @ 0.3 A (6)
ST-4-16*#	DST-4-16*#	16 VCT @ 0.4 A (7)	8 V @ 0.8 A (10)
ST-5-16*#	DST-5-16*#	16 VCT @ 0.8 A (10)	8 V @ 1.6 A (12)
ST-6-16	DST-6-16	16 VCT @ 1.25 A	8 V @ 2.5 A
ST-7-16	DST-7-16	16 VCT @ 2.25 A	8 V @ 4.5 A
ST-2-20**#	DST-2-20**#	20 VCT @ 0.055 A	10 V @ 0.11 A
ST-3-20*#	DST-3-20*#	20 VCT @ 0.12 A (2)	10 V @ 0.24 A (5)
ST-4-20*#	DST-4-20*#	20 VCT @ 0.3 A (6)	10 V @ 0.6 A (9)
ST-5-20*#	DST-5-20*#	20 VCT @ 0.6 A (9)	10 V @ 1.2 A (11)
ST-6-20	DST-6-20	20 VCT @ 1.0 A	10 V @ 2.0 A
ST-7-20	DST-7-20	20 VCT @ 1.8 A	10 V @ 3.6 A
ST-2-24**#	DST-2-24**#	24 VCT @ 0.045 A	12 V @ 0.09 A
ST-3-24*#	DST-3-24*#	24 VCT @ 0.1 A (1)	12 V @ 0.2 A (4)
ST-4-24*#	DST-4-24*#	24 VCT @ 0.25 A (5)	12 V @ 0.5 A (9)
ST-5-24*#	DST-5-24*#	24 VCT @ 0.5 A (9)	12 V @ 1.0 A (11)
ST-6-24	DST-6-24	24 VCT @ 0.8 A	12 V @ 1.6 A
ST-7-24	DST-7-24	24 VCT @ 1.5 A	12 V @ 3.0 A

Part Number		Secondary RMS Rating	
Single 115 V 6 Pin	Dual 115/230 V 8 Pin	Series	Parallel
ST-2-28	DST-2-28	28 VCT @ 0.04 A	14 V @ 0.08 A
ST-3-28	DST-3-28	28 VCT @ 0.085 A	14 V @ 0.17 A
ST-4-28	DST-4-28	28 VCT @ 0.2 A	14 V @ 0.4 A
ST-5-28	DST-5-28	28 VCT @ 0.42 A	14 V @ 0.84 A
ST-6-28	DST-6-28	28 VCT @ 0.7 A	14 V @ 1.4 A
ST-7-28	DST-7-28	28 VCT @ 1.3 A	14 V @ 2.6 A
ST-2-36	DST-2-36	36 VCT @ 0.03 A	18 V @ 0.06 A
ST-3-36	DST-3-36	36 VCT @ 0.065 A	18 V @ 0.13 A
ST-4-36	DST-4-36	36 VCT @ 0.17 A	18 V @ 0.34 A
ST-5-36	DST-5-36	36 VCT @ 0.35 A	18 V @ 0.7 A
ST-6-36	DST-6-36	36 VCT @ 0.55 A	18 V @ 1.1 A
ST-7-36	DST-7-36	36 VCT @ 1.0 A	18 V @ 2.0 A
ST-2-48	DST-2-48	48 VCT @ 0.023 A	24 V @ 0.046 A
ST-3-48	DST-3-48	48 VCT @ 0.05 A	24 V @ 0.1 A
ST-4-48	DST-4-48	48 VCT @ 0.125 A	24 V @ 0.25 A
ST-5-48	DST-5-48	48 VCT @ 0.25 A	24 V @ 0.5 A
ST-6-48	DST-6-48	48 VCT @ 0.4 A	24 V @ 0.8 A
ST-7-48	DST-7-48	48 VCT @ 0.75 A	24 V @ 1.5 A
ST-2-56	DST-2-56	56 VCT @ 0.02 A	28 V @ 0.04 A
ST-3-56	DST-3-56	56 VCT @ 0.045 A	28 V @ 0.09 A
ST-4-56	DST-4-56	56 VCT @ 0.11 A	28 V @ 0.22 A
ST-5-56	DST-5-56	56 VCT @ 0.22 A	28 V @ 0.44 A
ST-6-56	DST-6-56	56 VCT @ 0.35 A	28 V @ 0.7 A
ST-7-56	DST-7-56	56 VCT @ 0.65 A	28 V @ 1.3 A
ST-2-120	DST-2-120	120 VCT @ 0.01 A	60 V @ 0.02 A
ST-3-120	DST-3-120	120 VCT @ 0.02 A	60 V @ 0.04 A
ST-4-120	DST-4-120	120 VCT @ 0.05 A	60 V @ 0.1 A
ST-5-120	DST-5-120	120 VCT @ 0.1 A	60 V @ 0.2 A
ST-6-120	DST-6-120	120 VCT @ 0.16 A	60 V @ 0.32 A
ST-7-120	DST-7-120	120 VCT @ 0.3 A	60 V @ 0.6 A

Recommended secondary fuse value specified as below:

(1)	(2)	(3)	(4)	(5)	(6)	(7)	(8)	(9)	(10)	(11)	(12)	(13)
0.125 A	0.15 A	0.25 A	0.3 A	0.375 A	0.4 A	0.5 A	0.6 A	0.75 A	1.0 A	1.5 A	2.0 A	3.0 A

See Accessories datasheet for mounting screw information.



Custom versions available upon request.



128 Atlantic Avenue, Lynbrook, NY 11563  
 Toll Free 866-239-5777 | Tel 516-239-5777 | Fax 516-239-7208  
 sales@signaltransformer.com | techhelp@signaltransformer.com

[belfuse.com/signal](http://belfuse.com/signal)

## Mechanical Specifications

Size	VA	L	W	H	ML	A	B	C	Optional Mounting Screw & Nut •	Weight
		Inches (mm)								lbs (kg)
2	1.1	1.37 (34.9)	1.12 (28.6)	0.97 (24.6)	-	0.25 (6.4)	0.25 (6.4)	1.20 (30.5)	-	0.17 (0.08)
3	2.4	1.37 (34.9)	1.12 (28.6)	1.21 (30.8)	-	0.25 (6.4)	0.25 (6.4)	1.20 (30.5)	-	0.25 (0.11)
4	6	1.62 (41.3)	1.31 (33.3)	1.31 (33.3)	1.06 (26.9)	0.25 (6.4)	0.35 (8.9)	1.25 (31.8)	Nylon 4-40 x 1.37 (4-40 x 34.9)	0.44 (0.20)
5	12	1.91 (48.4)	1.59 (40.4)	1.45 (36.9)	1.25 (31.8)	0.30 (7.6)	0.40 (10.2)	1.41 (35.8)	Nylon 4-40 x 1.37 (4-40 x 34.9)	0.70 (0.32)
6	20	2.25 (57.2)	1.88 (47.8)	1.45 (36.9)	1.50 (38.1)	0.30 (7.6)	0.40 (10.2)	1.60 (40.6)	Nylon 4-40 x 1.37 (4-40 x 34.9)	0.80 (0.36)
7	36	2.62 (66.7)	2.18 (55.5)	1.59 (40.4)	••	0.40 (10.2)	0.40 (10.2)	1.85 (47.0)	••	1.1 (0.50)

- Available from Signal, part numbers ST-MS (screw) and ST-MN (nut).
- Size 7 has 4 mounting holes on 2.18 x 1.75 centers for #6 screws.

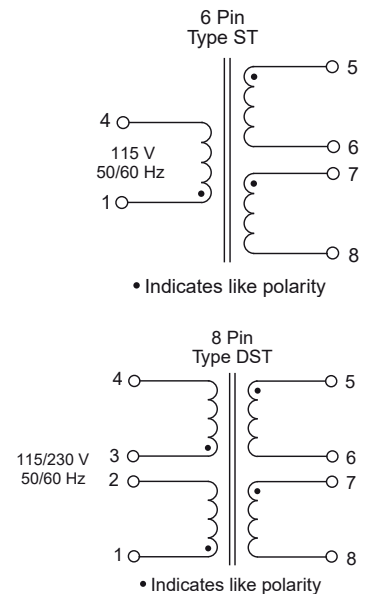
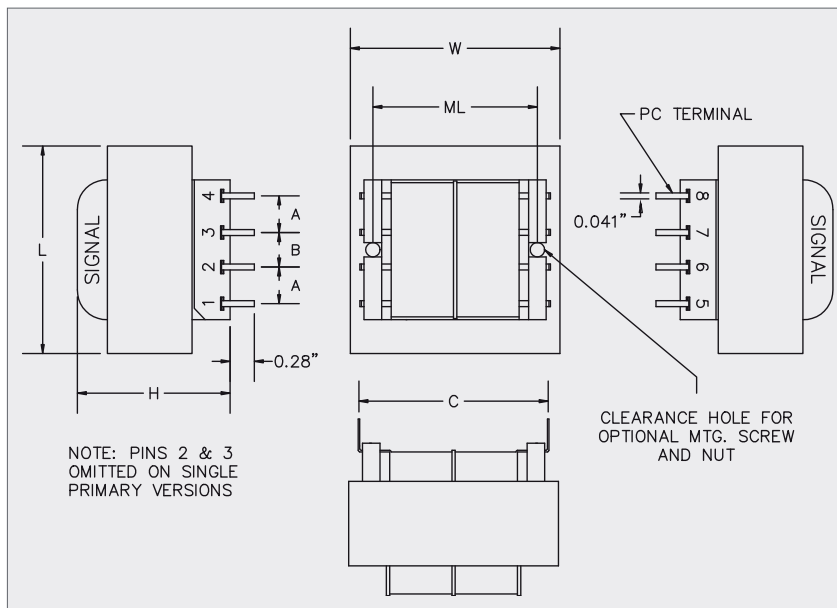

Custom versions available upon request.





128 Atlantic Avenue, Lynbrook, NY 11563  
Toll Free 866-239-5777 | Tel 516-239-5777 | Fax 516-239-7208  
sales@signaltransformer.com | techhelp@signaltransformer.com

[belfuse.com/signal](http://belfuse.com/signal)

## Looking for pricing, stock, or lifecycle information?

Click below to explore more details on WIN SOURCE:

-  [View ST-7-48 on WIN SOURCE](#)
-  [Signal Transformer Information](#)

## Optimize Your Supply Chain with WIN SOURCE Solutions

-  Global Sourcing Solution
-  Obsolete Management
-  Cost Control Management
-  Shortage Management
-  Alternative Solution
-  Excess Inventory Management