



**THE DATASHEET OF  
RAC04-12SA/277**



# NOT RECOMMENDED FOR NEW DESIGNS!

LAST TIME BUY: 30<sup>TH</sup> OCT 2020, 3.3SA, 09SA, 15SA, 0512DA

LAST TIME BUY: 30<sup>TH</sup> OCT 2020, "/277" VERSION EXCEPT 05 & 12 VOUT

## Features

## Regulated Converters

- Ultracompact AC-DC Power Supply
- 4 Watt PCB Mount Package
- Universal Input Voltage Range including 277VAC
- 3kVAC Isolation (Class II)
- Very Low No Load Input Current
- Dual output version for standby relay circuits
- Short Circuit Protected
- EN/UL Certified, CE Marked.

## Selection Guide

Part Number	Input Range (VAC)		Output Voltage (VDC)	Output Current (mA)	Efficiency (%)	Max Capacitive Load
	(Std)	(/277)				
RAC04-05SA*	90-264	90-305	5	800	72	8000µF
RAC04-12SA*	90-264	90-305	12	333	76	1000µF
RAC04-24SA	90-264	90-305	24	167	77	220µF

\* add suffix /277 for 90-305VAC input. High input voltage converters are identified by omitting pin 1.

## NRND (Last time buy: 30<sup>th</sup> Oct 2020)

Part Number	Input Range (VAC)		Output Voltage (VDC)	Output Current (mA)	Efficiency (%)	Max Capacitive Load
	(Std)	(/277)				
RAC04-3.3SA	90-264	90-305	3.3	1200	68	14000µF
RAC04-09SA	90-264	90-305	9	444	75	2400µF
RAC04-15SA	90-264	90-305	15	267	76	700µF
RAC04-0512DA	90-264	90-305	5/12	120/250	75	4700/330µF

## Specifications (typical at 25°C and after warm up time unless otherwise specified)

Input Voltage Range	standard /277 versions	90-264VAC or 120-370VDC 90-305VAC or 120-430VDC
Rated Power		4 Watts max
Input Frequency Range (for AC Input)		47-440Hz
Input Current (full load)	115/230VAC /277	95/65mA max. 75/55mA max.
No Load Power Consumption	115/230/277VAC	150/210/220mW typ.
Inrush Current (<0.5ms)	115/230VAC	15/25A max.
Leakage Current		0.25mA max
Output Voltage Accuracy (full load)	single outputs 3.3V (/277 Version)	±2% ±0.5%
Dual output version	5V/12V	±5%/±2%
Line Voltage Regulation (low line, high line at full load)		±0.2% typ
Dual output version	5V/12V	±3%/±0.2% typ
Load Voltage Regulation (0% to 100% full load)	3.3V output All others	±1% typ ( ±0.5% typ
Dual output version	5V/12V	±5%/±0.5% typ
Output Ripple and Noise (measured @ 20MHz of bandwidth with 0.1µF & 47µF parallel capacitor)	3.3V output 5V output All others	<250mVp-p max. <200mVp-p max. 100mVp-p max
Operating Frequency		132kHz typ
Hold-up time		15ms min.
Minimum Load	single outputs 5V/12V	0% 25%
RMS Isolation Voltage (input to output)		3kVAC / 1 minute
Temperature Coefficient		±0.02%/°C typ
Isolation Resistance		100 MΩ max
Short Circuit Protection		Hiccup, Automatic Restart
Output Overvoltage Protection		Zener Clamping Diode
Operating Temperature Range (natural convection, with derating)	All others Dual output version	-40°C to +70°C -40°C to +70°C
Storage Temperature Range		-40°C to +85°C
Humidity		95% RH max

continued on next page

## POWERLINE

AC/DC-Converter

with 3 year Warranty

RECOM

## 4 Watt Single/Dual Output

### PREFERRED ALTERNATIVES

Please consider these alternatives:

RAC04-GB Series

RAC04-K/277 Series



EN 55022/55024 Certified  
UL-60950-1 Certified

## RAC04-A

## Derating Graph (Ambient Temperature)

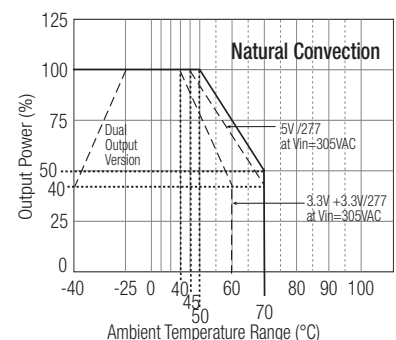

Refer to Application Notes

**POWERLINE**  
 AC/DC-Converter

**RAC04-SA**  
 Series

**Specifications** (typical at 25°C and after warm up time unless otherwise specified )

Case Material	Epoxy with Fibreglass (UL94V-0)		
Package Weight	26g		
Packing Quantity	12 pcs		
EMC	Conducted and Radiated	EN 55022 Class B	
	Noise Immunity	EN 55024	
MTBF (+25°C)	using MIL-HDBK-217F	>350 x 10 <sup>3</sup> hours	

**Typical Characteristics**

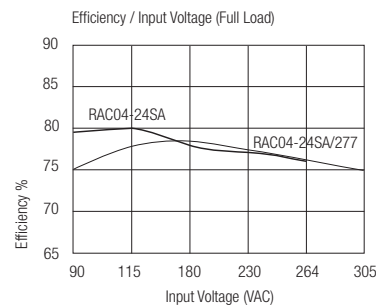
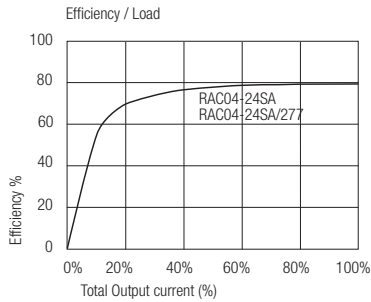

**Standard Package Style and Pinning**

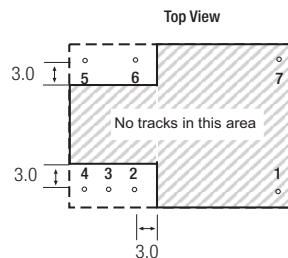
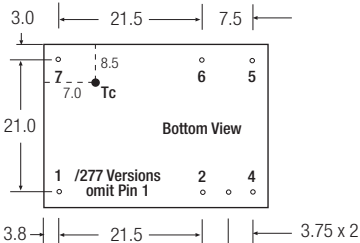
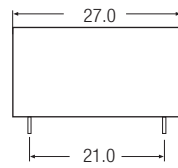
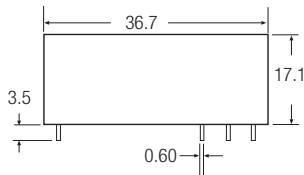

**Pin Connections**

Pin #	Single Output	Dual Output	/277 Versions
1	NC	NC	No Pin
2	+VDC out	+12V	same
3	-VDC out	Com	same
4	NC	+5V	same
5	VAC in (L)	VAC in (L)	VAC in (L)
6	VAC in (N)	VAC in (N)	VAC in (N)
7	NC	NC	NC

NC = No Connection

XX.X ± 0.5 mm  
 XX.XX ± 0.25 mm

It is recommended to additionally bond the /277 version of the converter to the PCB if the application is subject to vibration or mechanical shock.

**Standard Application Circuit**

**Standby Relay Application**

With 110VAC supply and 10mA standby load, the circuit consumes typically only 150mW.

Once activated by the remote handset, the standard 12V relay can switch a 16A load.

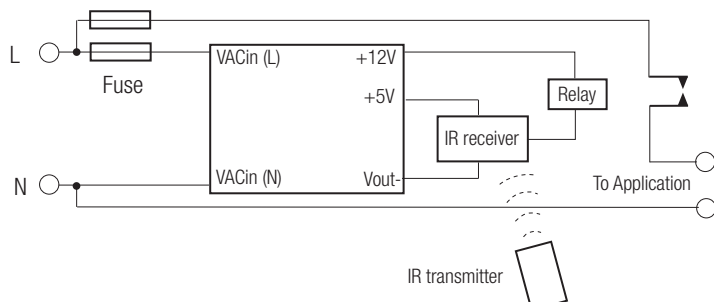

**Compact single output regulated power supply**

Suggested fuse rating:

1A Slow Blow

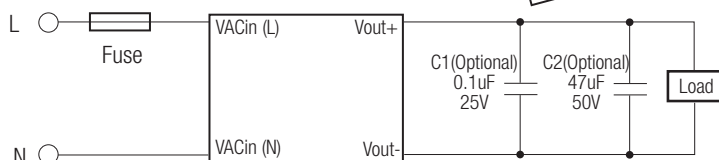

The product information and specifications may be subject to changes even without prior written notice. The product has been designed for various applications; its suitability lies in the responsibility of each customer. The products are not authorized for use in safety-critical applications without RECOM's explicit written consent. A safety-critical application is an application where a failure may reasonably be expected to endanger or cause loss of life, inflict bodily harm or damage property. The applicant shall indemnify and hold harmless RECOM, its affiliated companies and its representatives against any damage claims in connection with the unauthorized use of RECOM products in such safety-critical applications.

RAC04

## Looking for pricing, stock, or lifecycle information?

Click below to explore more details on WIN SOURCE:

- ⊖ [View RAC04-12SA/277](#) on WIN SOURCE
- ⊖ [Recom Power](#) Information

## Optimize Your Supply Chain with WIN SOURCE Solutions

- ✓ Global Sourcing Solution
- ✓ Obsolete Management
- ✓ Cost Control Management
- ✓ Shortage Management
- ✓ Alternative Solution
- ✓ Excess Inventory Management