

For NEW designs consider this replacement product:

• LUXEON TX



LUXEON N

Industry best thermal performance, 2A drive current, compatible with standard optics, 3-stripe footprint

LUXEON N is a high power LED in a 2.5mm x 2.5mm thermally optimized package that supports the highest drive current—up to 2A. This high current capability enables twice the flux in half the size compared to standard 3535 packages while achieving high efficacy. In addition to superior performance delivered over the widest operating range, LUXEON N is compatible with industry standard off-the-shelf optics, minimizing design efforts and costs. The thermally optimized package achieves the lowest thermal resistance at 2°C/W for high drive current system performance. These advantages provide total system design flexibility, making LUXEON N the ideal high power emitter choice for the next generation design of outdoor light sources.



FEATURES AND BENEFITS

Thermally optimized package provides the lowest R_{th} at 2°C/W

Highest drive current of 2A allows 670 lm+ per LED

Low V_f achieves high efficacy of 161 lm/W at 350mA and 110 lm/W at 2000mA

Radiation pattern compatible with standard 3535 high power packages and LUXEON TX

2525 package has half the footprint compared to standard 3535 ensuring fit under off-the-shelf optics

LM-80 data available at launch

PRIMARY APPLICATIONS

Architectural

High Bay & Low Bay

Outdoor

– Streetlights

Specialty Lighting

– Torch

Table of Contents

General Product Information	2
Product Test Conditions	2
Part Number Nomenclature	2
Lumen Maintenance	2
Environmental Compliance	2
Performance Characteristics	3
Product Selection Guide	3
Optical Characteristics	3
Electrical and Thermal Characteristics	3
Absolute Maximum Ratings	4
Characteristic Curves	4
Spectral Power Distribution Characteristics	4
Light Output Characteristics	5
Forward Current Characteristics	6
Radiation Pattern Characteristics	6
Product Bin and Labeling Definitions	8
Decoding Product Bin Labeling	8
Luminous Flux Bins	8
Color Bin Definition	9
Forward Voltage Bins	9
Mechanical Dimensions	10
Reflow Soldering Guidelines	11
JEDEC Moisture Sensitivity	11
Solder Pad Design	12
Packaging Information	12
Pocket Tape Dimensions	12
Reel Dimensions	13

General Product Information

Product Test Conditions

LUXEON N LEDs are tested and binned with a DC drive current of 700mA at a junction temperature, T_j , of 85°C.

Part Number Nomenclature

Part numbers for LUXEON N follow the convention below:

L 1 N 0 – **A A** 7 0 0 0 0 0 0 **B B B** 0

Where:

- A A** – designates nominal ANSI CCT (30=3000K, 40=4000K, 50=5000K, 57=5700K, 65=6500K)
- B B B** – designates minimum luminous flux level at test conditions (see Product Bin and Labeling section)

Therefore, the following part number is used for a LUXEON N 3000K 70CRI with a minimum luminous flux of 290 lumens:

L 1 N 0 – **3 0** 7 0 0 0 0 0 0 **2 9 0** 0

Lumen Maintenance

Please contact your local Sales Representative or Lumileds Technical Solutions Manager for more information about the long-term performance of this product.

Environmental Compliance

Lumileds LLC is committed to providing environmentally friendly products to the solid-state lighting market. LUXEON N is compliant to the European Union directives on the restriction of hazardous substances in electronic equipment, namely the RoHS Directive 2011/65/EU and REACH Regulation (EC) 1907/2006. Lumileds LLC will not intentionally add the following restricted materials to its products: lead, mercury, cadmium, hexavalent chromium, polybrominated biphenyls (PBB) or polybrominated diphenyl ethers (PBDE).

Performance Characteristics

Product Selection Guide

Table 1. Product performance of LUXEON N at 700mA and 2000mA, $T_j=85^\circ\text{C}$.

NOMINAL CCT	MINIMUM CRI ^[1, 2]	LUMINOUS FLUX ^[1] (lm)		TYPICAL LUMINOUS EFFICACY (lm/W)	TYPICAL LUMINOUS FLUX (lm)	TYPICAL LUMINOUS EFFICACY (lm/W)	PART NUMBER
		MINIMUM	TYPICAL				
		700mA					
3000K	70	250	265	135	614	105	L1N0-3070000000000
4000K	70	280	290	148	671	113	L1N0-4070000000000
5000K	70	280	290	148	671	113	L1N0-5070000000000
5700K	70	280	290	148	671	113	L1N0-5770000000000
6500K	70	280	290	148	671	113	L1N0-6570000000000

Notes for Table 1:

- Lumileds maintains a tolerance of ± 2 on CRI and $\pm 6.5\%$ on luminous flux measurements.
- Typical CRI is approximately 2 points higher than the minimum CRI specified, but this is not guaranteed.

Optical Characteristics

Table 2. Optical characteristics for LUXEON N at 700mA, $T_j=85^\circ\text{C}$.

PART NUMBER	TYPICAL TOTAL INCLUDED ANGLE ^[1]	TYPICAL VIEWING ANGLE ^[2]
L1N0-xx7000000xxx0	160°	120°

Notes for Table 2:

- Total angle at which 90% of total luminous flux is captured.
- Viewing angle is the off axis angle from the LED centerline where the luminous intensity is $\frac{1}{2}$ of the peak value.

Electrical and Thermal Characteristics

Table 3. Electrical and thermal characteristics for LUXEON N at 700mA, $T_j=85^\circ\text{C}$.

PART NUMBER	FORWARD VOLTAGE ^[1] (V _f)			TYPICAL TEMPERATURE COEFFICIENT OF FORWARD VOLTAGE ^[2] (mV/°C)	TYPICAL THERMAL RESISTANCE—JUNCTION TO SOLDER PAD (°C/W)
	MINIMUM	TYPICAL	MAXIMUM		
L1N0-xx7000000xxx0	2.5	2.8	3.0	-1.6°	2.0°

Notes for Table 3:

- Lumileds maintains a tolerance of $\pm 0.06\text{V}$ on forward voltage measurements.
- Measured between 25°C and 85°C.

Absolute Maximum Ratings

Table 4. Absolute maximum ratings for LUXEON N.

PARAMETER	MAXIMUM PERFORMANCE		
DC Forward Current ^[1,2]	1050mA	1225mA	2000mA
Peak Pulsed Forward Current ^[1,3]	1200mA	1750mA	2500mA
LED Junction Temperature ^[1] (DC & Pulse)	150°C	135°C	100°C
ESD Sensitivity (ANSI/ESDA/JEDEC JS-001-2012)	Class 3B		
Operating Case Temperature ^[1]	-40°C to 135°C		
LED Storage Temperature	-40°C to 135°C		
Soldering Temperature	JEDEC 020c 260°C		
Allowable Reflow Cycles	3		
Reverse Voltage ($V_{reverse}$) ^[4]	LUXEON LEDs are not designed to be driven in reverse bias		

Notes for Table 4:

1. Proper current derating must be observed to maintain the junction temperature below the maximum allowable junction temperature.
2. Residual periodic variations due to power conversion from alternating current (AC) to direct current (DC), also called "ripple," with frequencies $\geq 100\text{Hz}$ and amplitude $\leq 15\%$ of the maximum allowable DC forward current are acceptable, assuming the average current throughout each cycle does not exceed the maximum allowable DC forward current at the corresponding maximum junction temperature.
3. Pulsed operation with a peak drive current equal to the stated peak pulsed forward current is acceptable if the pulse on-time is $\leq 5\text{ms}$ per cycle and the duty cycle is $\leq 50\%$.
4. Transient reverse voltages and surge currents due to electrical switching or supply interruptions are acceptable if these events do not last for more than 10ms, the amplitude of the reverse voltage does not exceed 5V and the reverse current is less than 220uA.

Characteristic Curves

Spectral Power Distribution Characteristics

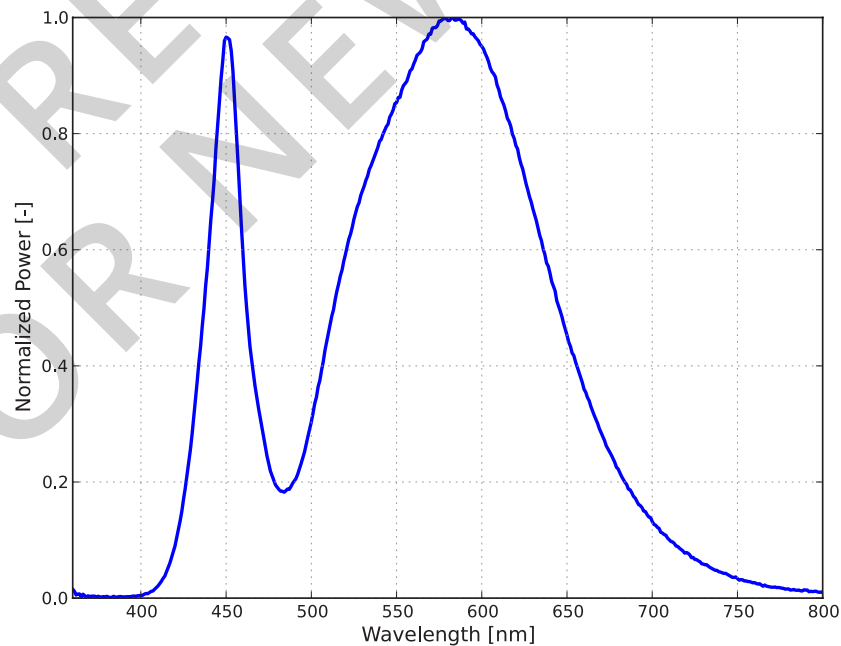

Figure 1. Typical normalized power vs. wavelength for LUXEON N at 700mA, $T_j=85^\circ\text{C}$.

Light Output Characteristics

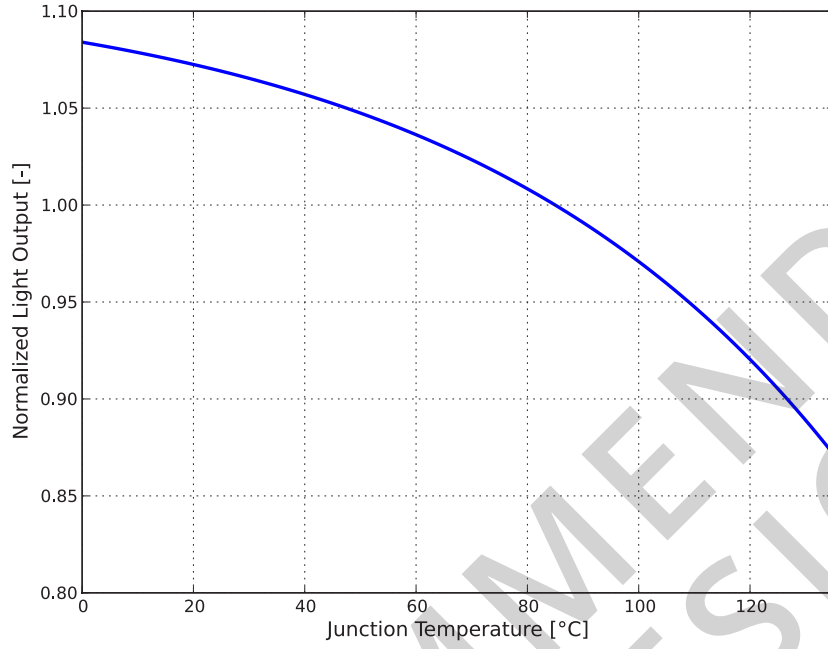

Figure 2. Typical normalized light output vs. junction temperature for LUXEON N at 700mA.

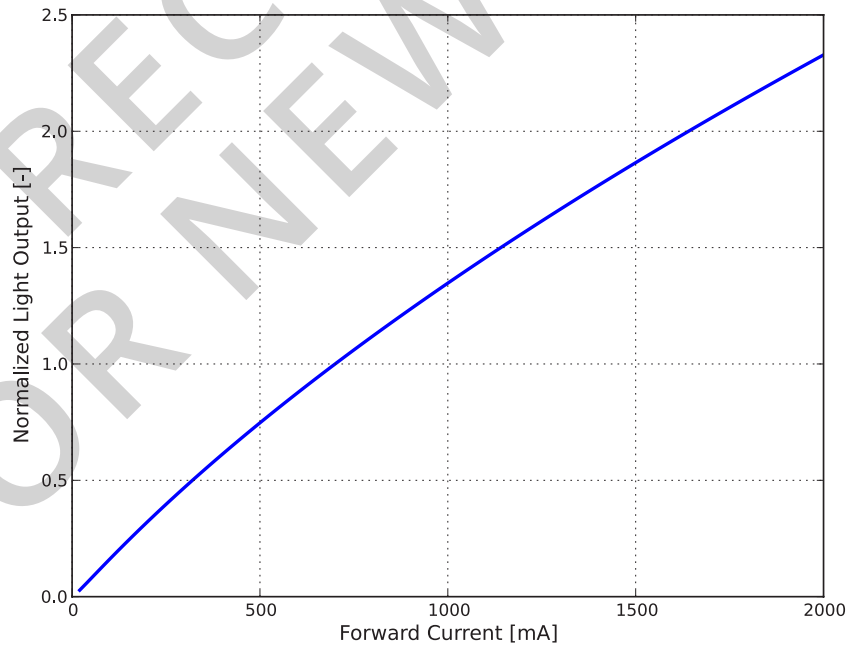

Figure 3. Typical normalized light output vs. forward current for LUXEON N at $T_j=85^{\circ}\text{C}$.

Forward Current Characteristics

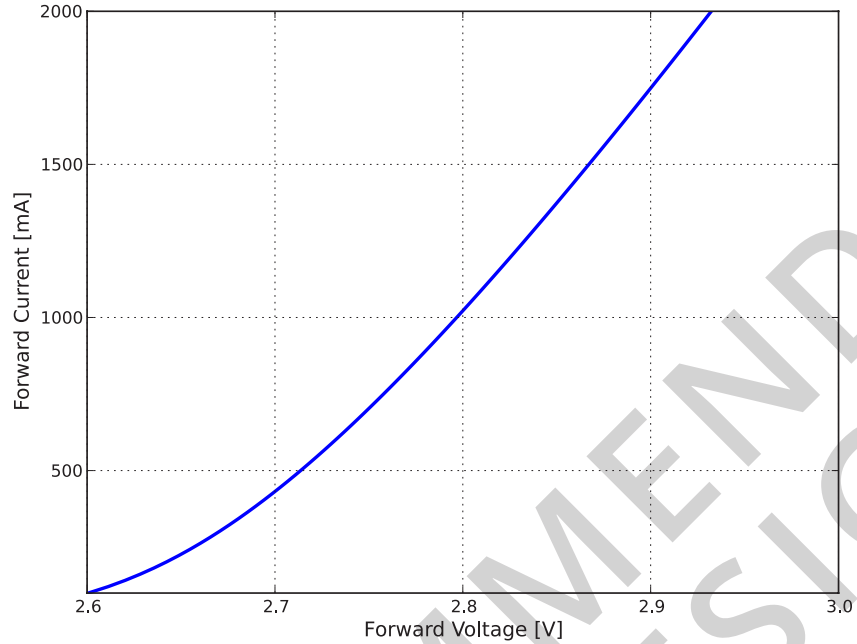

Figure 4. Typical forward current vs. forward voltage for LUXEON N at $T_j=85^\circ\text{C}$.

Radiation Pattern Characteristics

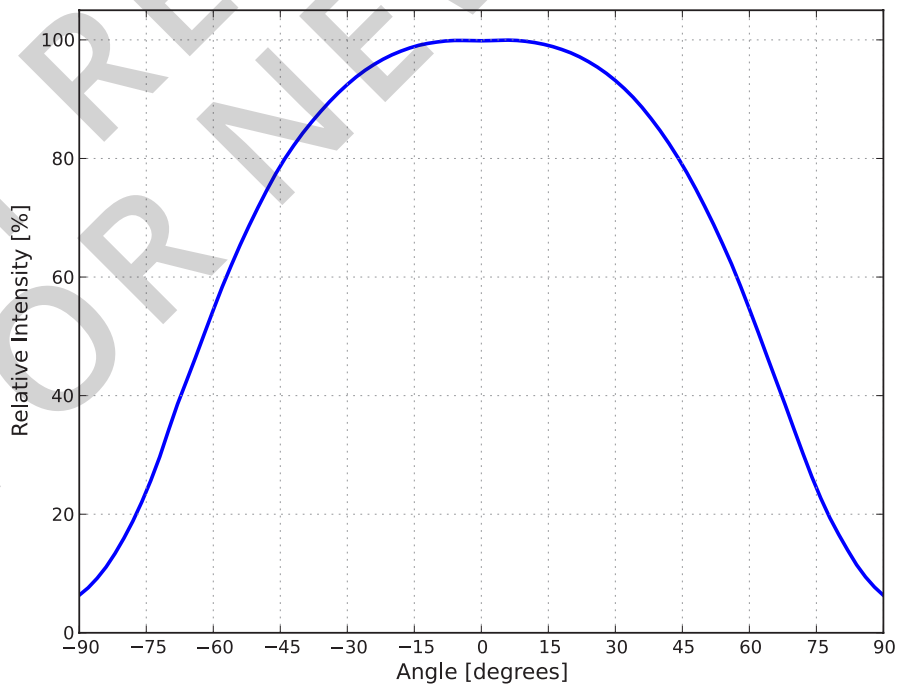

Figure 5. Typical radiation pattern for LUXEON N at 700mA, $T_j=85^\circ\text{C}$.

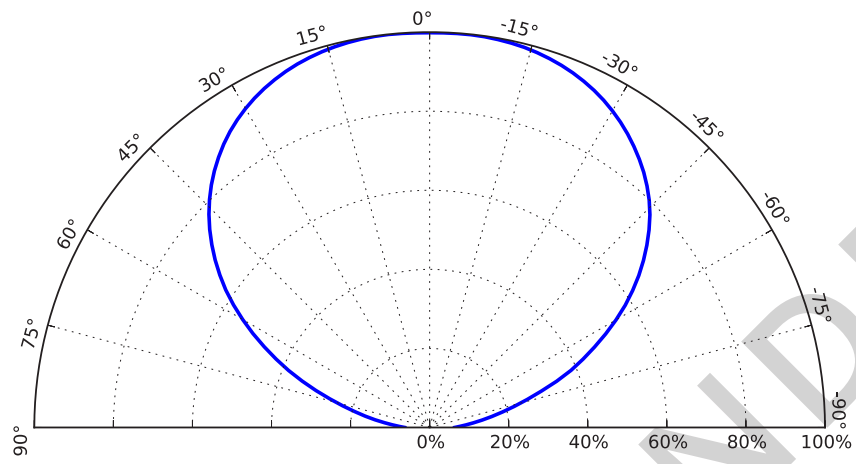

Figure 6. Typical polar radiation pattern for LUXEON N at 700mA, $T_j=85^\circ\text{C}$.

NOT RECOMMENDED
FOR NEW DESIGNS

Product Bin and Labeling Definitions

Decoding Product Bin Labeling

In the manufacturing of semiconductor products, there are variations in performance around the average values given in the technical datasheet. For this reason, Lumileds bins LED components for luminous flux or radiometric power, color point, peak or dominant wavelength and forward voltage.

LUXEON N LEDs are labeled using a 4-digit alphanumeric CAT code following the format below:

Where:

A B C D

- A** – designates luminous flux bin (example: U=280 to 290 lumens, V=290 to 300 lumens)
- B** – designates correlated color temperature (CCT) bin (1=6500K, 2=5700K, 3=5000K, 5=4000K, 7=3000K)
- C** – designates SDCM bin (example: 5=5-step MacAdam ellipse)
- D** – designates forward voltage bin (example: X=2.65 to 2.85V, Y=2.85 to 3.00V)

Therefore, a LUXEON N with a lumen range of 290 to 300, SDCM bin of 5, CCT bin of 4000K and a forward voltage range of 2.65 to 2.85V has the following CAT code:

V 5 5 X

Luminous Flux Bins

Table 5 lists the standard luminous flux bins for LUXEON N emitters. Although several bins are outlined, product availability in a particular bin varies by production run and by product performance. Not all bins are available in all CCTs.

Table 5. Luminous flux bin definitions for LUXEON N, $T_j=85^\circ\text{C}$.

BIN	LUMINOUS FLUX ⁽¹⁾ (lm)	
	MINIMUM	MAXIMUM
Q	240	250
R	250	260
S	260	270
T	270	280
U	280	290
V	290	300
W	300	310

Notes for Table 5:

1. Lumileds maintains a tolerance of $\pm 6.5\%$ on luminous flux measurements.

Color Bin Definition

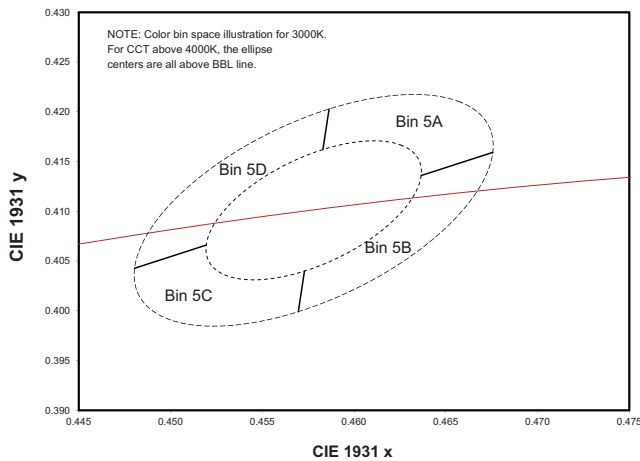

Figure 7. Color space definition for LUXEON N.

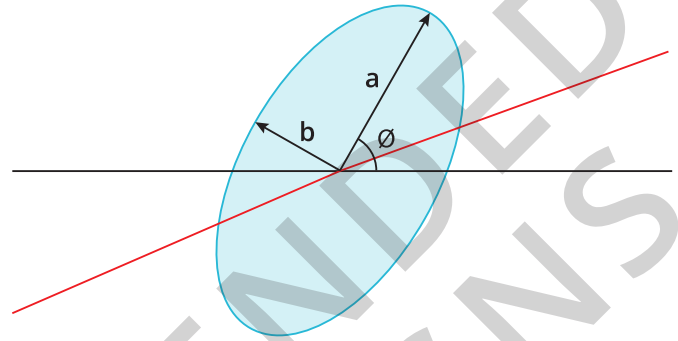

Figure 8. 5-step MacAdam ellipse illustration for Table 6.

Table 6. 5-step MacAdam ellipse color bin definitions for LUXEON N.

NOMINAL CCT	COLOR SPACE	CENTER POINT ^[1] (cx, cy)	MAJOR AXIS, a	MINOR AXIS, b	ELLIPSE ROTATION ANGLE, θ
3000K	Single 5-step MacAdam ellipse	(0.4338, 0.4030)	0.01390	0.00680	53.2°
4000K	Single 5-step MacAdam ellipse	(0.3818, 0.3797)	0.01565	0.00670	53.7°
5000K	Single 5-step MacAdam ellipse	(0.3447, 0.3553)	0.01370	0.00590	59.6°
5700K	Single 5-step MacAdam ellipse	(0.3287, 0.3417)	0.01243	0.00533	59.1°
6500K	Single 5-step MacAdam ellipse	(0.3123, 0.3282)	0.01115	0.00475	58.6°

Notes for Table 6:

1. Lumileds maintains a tolerance of ± 0.005 on x and y color coordinates in the CIE 1931 color space.

Table 7. MacAdam ellipse color bin definitions for LUXEON N.

BIN	SDCM
5A	5-step MacAdam ellipse
5B	5-step MacAdam ellipse
5C	5-step MacAdam ellipse
5D	5-step MacAdam ellipse

Forward Voltage Bins

Table 8. Forward voltage bin definitions for LUXEON N, $T_j=85^\circ\text{C}$.

BIN	FORWARD VOLTAGE ^[1] (V_f)	
	MINIMUM	MAXIMUM
X	2.65	2.85
Y	2.85	3.00

Notes for Table 8:

1. Lumileds maintains a tolerance of $\pm 0.06\text{V}$ on forward voltage measurements.

Mechanical Dimensions

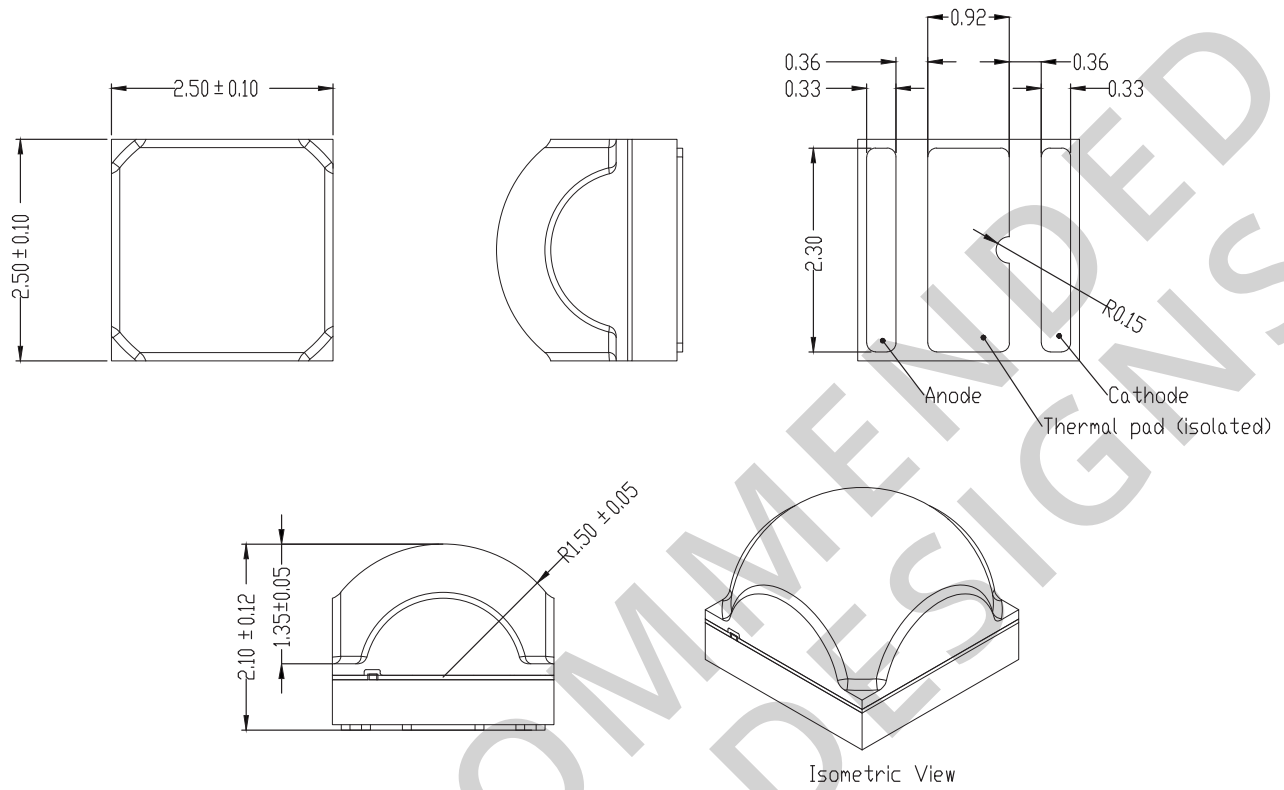

Figure 9. Mechanical dimensions for LUXEON N.

Notes for Figure 9:

1. Drawings are not to scale.
2. All dimensions are in millimeters.

Reflow Soldering Guidelines

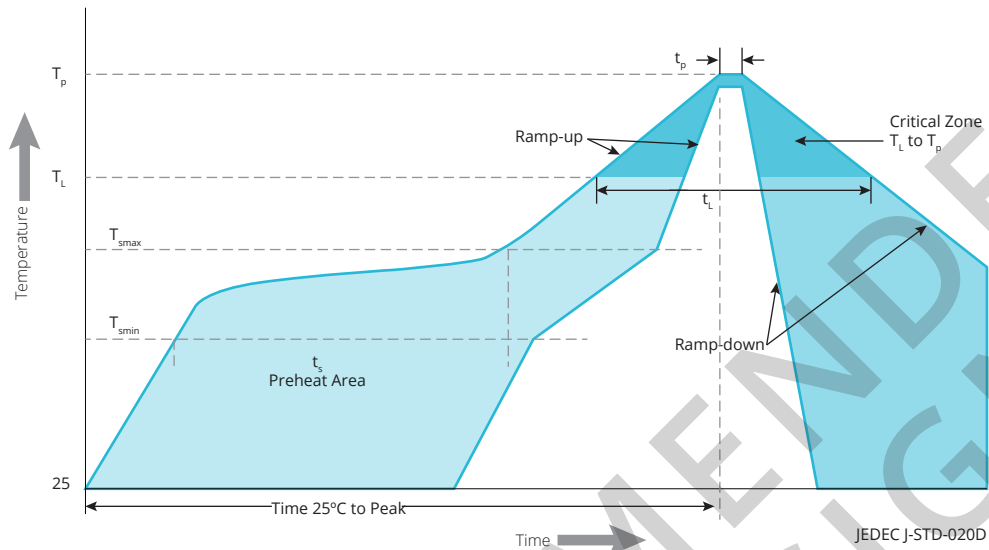

Figure 10. Visualization of the acceptable reflow temperature profile as specified in Table 9.

Table 9. Reflow profile characteristics for LUXEON N.

PROFILE FEATURE	LEAD-FREE ASSEMBLY
Preheat Minimum Temperature (T_{smin})	150°C
Preheat Maximum Temperature (T_{smax})	200°C
Preheat Time (t_{smin} to t_{smax})	60 to 180 seconds
Ramp-Up Rate (T_L to T_p)	3°C / second maximum
Liquidus Temperature (T_L)	217°C
Time Maintained Above Temperature T_L (t_t)	60 to 150 seconds
Peak / Classification Temperature (T_p)	260°C
Time Within 5°C of Actual Temperature (t_p)	20 to 40 seconds
Ramp-Down Rate (T_p to T_L)	6°C / second maximum
Time 25°C to Peak Temperature	8 minutes maximum

JEDEC Moisture Sensitivity

Table 10. Moisture sensitivity levels for LUXEON N.

LEVEL	FLOOR LIFE		SOAK REQUIREMENTS STANDARD	
	TIME	CONDITIONS	TIME	CONDITIONS
1	Unlimited	≤30°C / 85% RH	168 Hours +5 / -0	85°C / 85% RH

Reel Dimensions

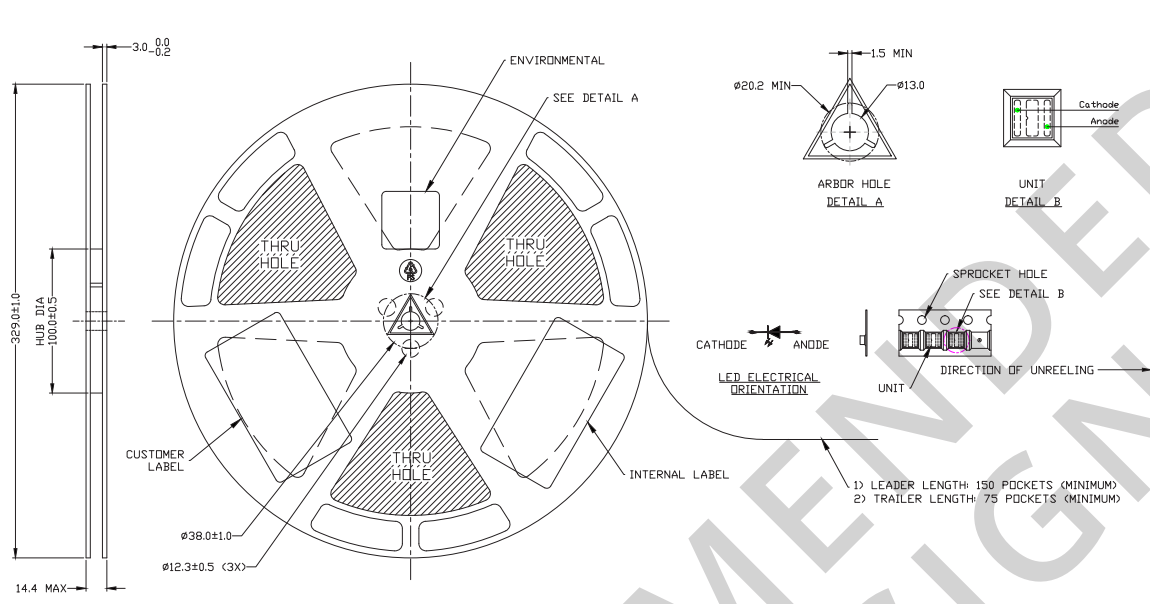

Figure 13. Reel dimensions for LUXEON N.

Notes for Figure 13:

1. Drawings are not to scale.
2. All dimensions are in millimeters.

NOT RECOMMENDED FOR NEW DESIGNS

About Lumileds

Companies developing automotive, mobile, IoT and illumination lighting applications need a partner who can collaborate with them to push the boundaries of light. With over 100 years of inventions and industry firsts, Lumileds is a global lighting solutions company that helps customers around the world deliver differentiated solutions to gain and maintain a competitive edge. As the inventor of Xenon technology, a pioneer in halogen lighting and the leader in high performance LEDs, Lumileds builds innovation, quality and reliability into its technology, products and every customer engagement. Together with its customers, Lumileds is making the world safer, better and more beautiful—with light.

To learn more about our lighting solutions, visit lumileds.com.

NOT RECOMMENDED
FOR NEW DESIGNS



©2018 Lumileds Holding B.V. All rights reserved. LUXEON is a registered trademark of the Lumileds Holding B.V. in the United States and other countries.

lumileds.com

Neither Lumileds Holding B.V. nor its affiliates shall be liable for any kind of loss of data or any other damages, direct, indirect or consequential, resulting from the use of the provided information and data. Although Lumileds Holding B.V. and/or its affiliates have attempted to provide the most accurate information and data, the materials and services information and data are provided "as is," and neither Lumileds Holding B.V. nor its affiliates warrants or guarantees the contents and correctness of the provided information and data. Lumileds Holding B.V. and its affiliates reserve the right to make changes without notice. You as user agree to this disclaimer and user agreement with the download or use of the provided materials, information and data. A listing of Lumileds product/patent coverage may be accessed at lumileds.com/patents.

Looking for pricing, stock, or lifecycle information?

Click below to explore more details on WIN SOURCE:

 [View L1N0-6570000000000 on WIN SOURCE](#)

 [Lumileds Information](#)

Optimize Your Supply Chain with WIN SOURCE Solutions

-  Global Sourcing Solution
-  Obsolete Management
-  Cost Control Management
-  Shortage Management
-  Alternative Solution
-  Excess Inventory Management