



**THE DATASHEET OF
752091102GPTR7**





752 Series Surface Mount Resistor Network

Features

- Low Profile Surface Mount Lead-Less Package
- Solid Ceramic Construction
- High Density Packaging
 - Single Row [SRT] & Dual Row [DRT] Terminations
- Nickel Barrier Solder-Coated Pads
- No Internal Dendrite Growth
- Designed for Visual Inspection & Board Cleaning
- Tape and Reel Packaging

RoHS Compliant in Accordance with EU Directive 2011/65/EU

- Lead-Free Termination Finish
- Exemption 7(c)-I, Electrical and electronic components containing lead [Pb] in glass

Part Weight:

- 08/16 Pads • 180.70mg
- 09/18 Pads • 203.30mg
- 10/20 Pads • 225.90mg
- 12/24 Pads • 271.10mg

Applications

- Telecom Infrastructure
- Optical Networking
- Wireless Networks
- Storage Area Networks
- Media Servers
- Test & Measurement
- Industrial Controls
- Medical Electronics
- Commercial Military & Aerospace

Description

752 Series Resistor Networks are single packaged devices containing an array of homogeneous resistor elements. CTS network designs provide a smaller circuit footprint, excellent reliability, improved TCR tracking and resistor tolerance matching; while helping to save placement costs by reducing application component count.

Ordering Information

Model	Number of Pins	Schematic	Resistor Code	Resistor Tolerance	RoHS Compliant	Packaging																																																			
752	08	3	103	G	P	TR7																																																			
<table border="1"> <thead> <tr> <th>Code</th> <th>Pin Count</th> <th>Code</th> <th>Pin Count</th> </tr> <tr> <th>SRT</th> <th>DRT</th> <th></th> <th></th> </tr> </thead> <tbody> <tr> <td>08</td> <td>8 Pads</td> <td>16</td> <td>16 Pads</td> </tr> <tr> <td>09</td> <td>9 Pads</td> <td>18</td> <td>18 Pads</td> </tr> <tr> <td>10</td> <td>10 Pads</td> <td>20</td> <td>20 Pads</td> </tr> <tr> <td>12</td> <td>12 Pads</td> <td>24</td> <td>24 Pads</td> </tr> </tbody> </table>		Code	Pin Count	Code	Pin Count	SRT	DRT			08	8 Pads	16	16 Pads	09	9 Pads	18	18 Pads	10	10 Pads	20	20 Pads	12	12 Pads	24	24 Pads	<table border="1"> <thead> <tr> <th>Code</th> <th>Schematic Type</th> </tr> </thead> <tbody> <tr> <td>1</td> <td>Busser Circuit</td> </tr> <tr> <td>3</td> <td>Isolated Circuit</td> </tr> <tr> <td>5</td> <td>Dual Terminator Circuit</td> </tr> </tbody> </table>		Code	Schematic Type	1	Busser Circuit	3	Isolated Circuit	5	Dual Terminator Circuit	<table border="1"> <thead> <tr> <th colspan="2">Code Resistor Value *</th> </tr> </thead> <tbody> <tr> <td>103</td> <td>10k ohm</td> </tr> </tbody> </table> <p>* See Addendum for Standard EIA Values and Codes</p>		Code Resistor Value *		103	10k ohm	<table border="1"> <thead> <tr> <th colspan="2">Code Compliance</th> </tr> </thead> <tbody> <tr> <td>P</td> <td>RoHS</td> </tr> </tbody> </table>		Code Compliance		P	RoHS	<table border="1"> <thead> <tr> <th colspan="2">Code Packing</th> </tr> </thead> <tbody> <tr> <td>Blank</td> <td>Bulk Pack</td> </tr> <tr> <td>TR7</td> <td>Tape & Reel, 7"</td> </tr> <tr> <td>TR13</td> <td>Tape & Reel, 13"</td> </tr> </tbody> </table>		Code Packing		Blank	Bulk Pack	TR7	Tape & Reel, 7"	TR13	Tape & Reel, 13"
Code	Pin Count	Code	Pin Count																																																						
SRT	DRT																																																								
08	8 Pads	16	16 Pads																																																						
09	9 Pads	18	18 Pads																																																						
10	10 Pads	20	20 Pads																																																						
12	12 Pads	24	24 Pads																																																						
Code	Schematic Type																																																								
1	Busser Circuit																																																								
3	Isolated Circuit																																																								
5	Dual Terminator Circuit																																																								
Code Resistor Value *																																																									
103	10k ohm																																																								
Code Compliance																																																									
P	RoHS																																																								
Code Packing																																																									
Blank	Bulk Pack																																																								
TR7	Tape & Reel, 7"																																																								
TR13	Tape & Reel, 13"																																																								
				<table border="1"> <thead> <tr> <th colspan="2">Schematic Types 1 & 3</th> <th colspan="2">Schematic Type 5</th> </tr> <tr> <th>Code</th> <th>Tolerance</th> <th>Code</th> <th>Tolerance</th> </tr> </thead> <tbody> <tr> <td>G</td> <td>±2% [std]</td> <td>Blank</td> <td>±2%</td> </tr> <tr> <td>F</td> <td>±1%</td> <td></td> <td></td> </tr> <tr> <td>D</td> <td>±0.5%</td> <td></td> <td></td> </tr> <tr> <td>J</td> <td>±5%²</td> <td></td> <td></td> </tr> </tbody> </table>		Schematic Types 1 & 3		Schematic Type 5		Code	Tolerance	Code	Tolerance	G	±2% [std]	Blank	±2%	F	±1%			D	±0.5%			J	±5% ²																														
Schematic Types 1 & 3		Schematic Type 5																																																							
Code	Tolerance	Code	Tolerance																																																						
G	±2% [std]	Blank	±2%																																																						
F	±1%																																																								
D	±0.5%																																																								
J	±5% ²																																																								

Notes:

1. No dashes or spaces to appear in part number.
2. Not supported per PCN ECP-3200029. Use code "G" as standard platform tolerance.

**Not all performance combinations and resistor values may be available.
Contact your local CTS Representative or CTS Customer Service for availability.**

This product is specified for use only in standard commercial applications. Supplier disclaims all express and implied warranties and liability in connection with any use of this product in any non-commercial applications or in any application that may expose the product to conditions that are outside of the tolerances provided in its specification.



Electrical & Environmental Specifications

Operating Conditions

Resistance Range [ohm]	Resistance Tolerance [%] ¹	Operating Temperature Range	Temperature Coefficient	Dielectric Strength	Maximum Operating Voltage ²
10 - 1M	±2% Std. or 0.5 ohm [whichever is greater]	-55°C to +125°C	±200ppm/°C [standard, 10 Ohms - 1M] ±100ppm/°C [special, 33 ohms - 1M ohms]	100V _{AC}	25V

1. See Ordering Information for other options available.

2. Not to exceed rated power.

Power Rating

SRT DRT	8 Pad	9 Pad	10 Pad	12 Pad	- 16 Pad	- 18 Pad	- 20 Pad	- 24 Pad
@ +25°C	1.2W	1.3W	1.4W	1.7W	1.4W	1.5W	1.6W	2.0W
@ +70°C	0.08W	0.85W	0.90W	1.1W	0.90W	0.95W	1.0W	1.3W

1. Total network power.

Maximum Resistor Power

Schematic	1	3	5
@ +25°C	0.12W	0.24W	0.12W
@ +70°C	0.08W	0.16W	0.08W

1. Not to exceed total network power.

Power Derating Curve

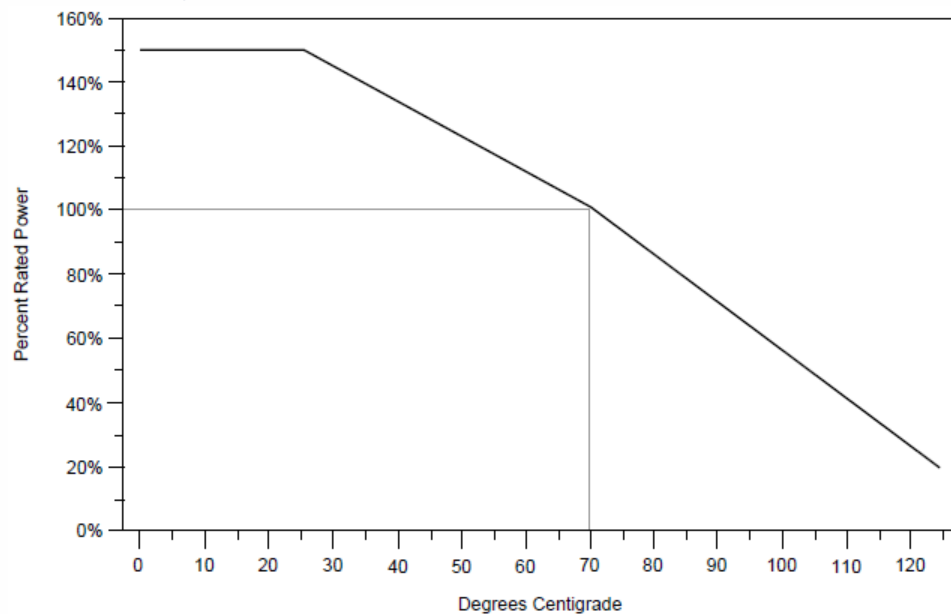

Electrical & Environmental Specifications

Circuit Types

Bussed SRT [Schematic 1]

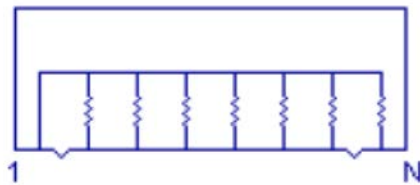

Isolated SRT [Schematic 3]

[Not available in 9 Pads Configuration]

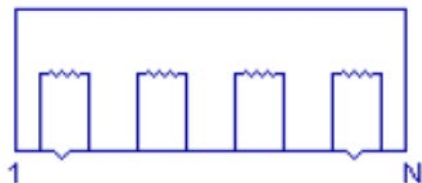

Dual Terminator SRT [Schematic 5]

[Not available in DRT]

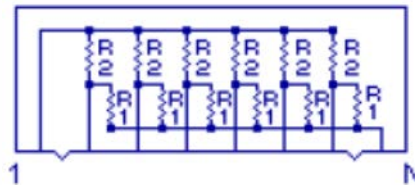

Bussed DRT [Schematic 1]

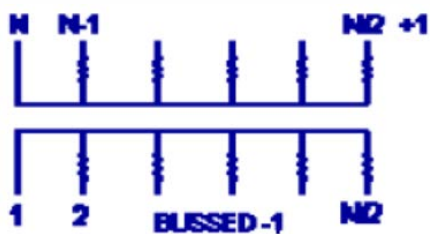

Isolated DRT [Schematic 3]

[Not available in 18 Pads configuration]



Environmental Parameters

Test	Maximum Delta R [%]	MIL-STD-202 Method	Test Description
Thermal Cycle	0.50	107 Condition B	5 cycles -65°C to +125°C
Short Time Overload	0.50		2½ times rated working voltage for 5 seconds [100V maximum]
Moisture Resistance	0.50	106	240 hours, 0.1 rated load, -10°C to +65°C, 90% RH
Load Humidity	1.00		1,000 hours, 0.1 rated load, +70°C, 85% - 92% RH
High Temperature Exposure	1.00		240 hours @ +125°C, no load
Load Life	1.00	108 Condition F	2,000 hours @ +70°C, rated load
Resistance to Solder Heat	0.25		30 seconds @ +218°C, dwell
Mechanical Shock	0.25	213 Condition I	100g, 1m second, 3 shocks each plane
Vibration	0.25	204 Condition D	20g, 10Hz - 2,000Hz, 4 houes per plane
Leaching Test	No leach > 50%	EIA/IS-703-4.13.B	Immererse in +245°C ±5°C SAC305 solder pot for 30 sec.
Shear Test	NA		≥ 2,000PSI
Low Temperature Storage	0.25		24 hours @ -65°C, no load
Low Temperature Operation	0.25		45 minutes @ -65°C, full load
Flammability	N/A		94V-0
Non-Fungus	Pass	---	MIL-STD-810C
Resistance to Solvents	Pass		Isopropyl alcohol, Freon TMC
Solderability	Pass		RMA Flux, +230°C, 5 seconds dip, 95% coverage

Mechanical Specifications

Package Drawing

Package SRT/DRT Pads	"A" Code Dimension	
	mm	inch
08/16	11.81 ±0.12	0.465 ±0.005
09/18	13.08 ±0.12	0.515 ±0.005
10/20	14.35 ±0.12	0.565 ±0.005
12/24	16.89 ±0.12	0.665 ±0.005

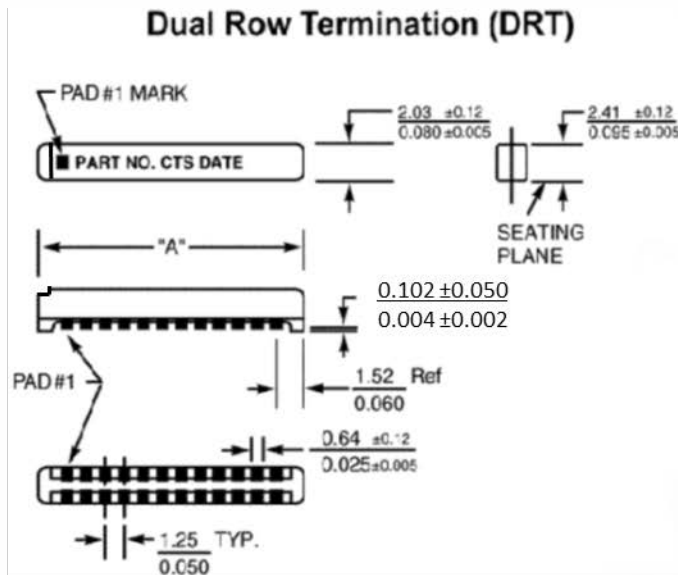
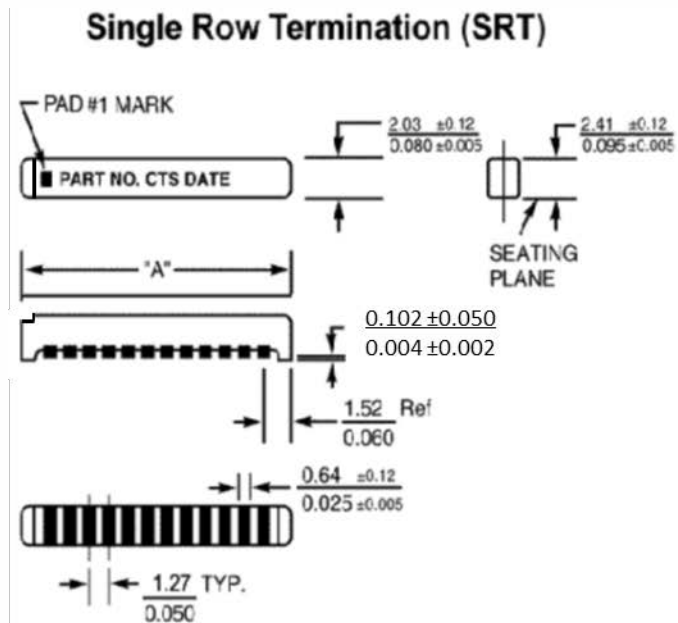

Notes

- JEDEC termination code (e3). Barrier plating is nickel [Ni] over silver [Ag] thick film pad with Matte tin [Sn] finish.
- Reflow conditions per JEDEC-J-STD-020; +260°C maximum, 20 seconds.
- MSL = 1.

Marking Information

- – Pin 1 identifier.
 - zz – Pad count, 8, 9, 10, 12, 16, 18, 20 or 24.
 - S – Schematic type, 1, 3 or 5.
 - xxxx – Resistance value code, 3 or 4 digits.
 - T – Resistor tolerance code; G, F or D. Leave blank for Schematic Code 5.
 - P – RoHS compliant.
 - CTS – Manufacturer.
 - YYWW – Date Code: YY – year, WW – week.
- * See table for marking examples.

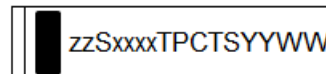

Mechanical Specifications

Marking Examples

Pad Count [SRT/DRT]	Pad 1 Identifier	Pad Count	Schematic Number	Resistance Value Code	Resistor Tolerance	Lead-Free P Code	CTS Logo	Date Code	Marking Example	Associated Part Number
12/24	Yes	Yes	Yes	Yes	Yes	Yes	Yes	Yes		752123220GP
10/20	Yes	Yes	Yes	Yes	Yes	Yes	Yes	Yes		752101103GP
9/18	Yes	Yes	Yes	Yes	Yes	Yes	Yes	Yes		752091472GP
8/16	Yes	Yes	Yes	Yes	Yes	Yes	Yes	Yes		752083681GP

Recommended Solder Pad Layout

Package		Dimensions					
		D	P	L	W	J	S
752	mm	1.27	1.27	3.18	0.76	1.27	0.64
	inch	0.05	0.05	0.125	0.03	0.05	0.025

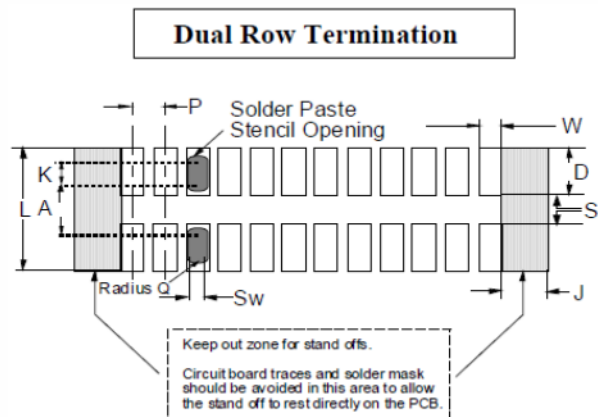
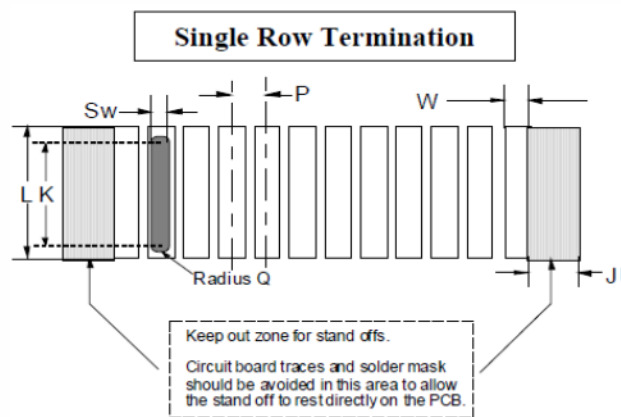

SRT Solder Stencil Opening

752, SRT		Dimensions			
		K	Sw	A	Q
4 mil	mm	2.40	0.76	NA	0.38
	inch	0.095	0.03	NA	0.015
6 mil	mm	1.90	0.63	NA	0.33
	inch	0.075	0.025	NA	0.012

DRT Solder Stencil Opening

752, DRT		Dimensions			
		K	Sw	A	Q
4 mil	mm	0.66	0.76	1.52	0.38
	inch	0.026	0.03	0.06	0.015
6 mil	mm	0.51	0.63	1.40	0.33
	inch	0.02	0.025	0.055	0.012

Packaging

Tape and Reel Information

Reel Diameter	180mm [7"]	330mm [13"]
Parts Per Reel	1,000	3,000
Pitch	4mm	4mm
Carrier Width	24mm	24mm
Material	Plastic	Plastic

1. See Ordering Information for packaging code

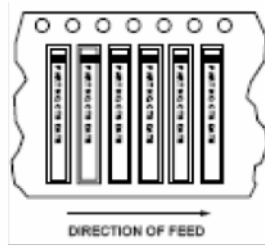

Bulk In Bag

- Standard quantity is 250pcs. per bag.



Addendum

Standard EIA Codes and Resistor Values – E-24 [3-Digit Resistor Code for G, F & D Tolerances]

CODE	OHMS	CODE	OHMS	CODE	OHMS	CODE	OHMS	CODE	OHMS	CODE	OHMS
000X ¹	0	680	68	511	510	392	3,900	303	30,000	224	220,000
100	10	750	75	561	560	432	4,300	333	33,000	244	240,000
110	11	820	82	621	620	472	4,700	363	36,000	274	270,000
120	12	910	91	681	680	512	5,100	393	39,000	304	300,000
130	13	101	100	751	750	562	5,600	433	43,000	334	330,000
150	15	111	110	821	820	622	6,200	473	47,000	364	360,000
160	16	121	120	911	910	682	6,800	513	51,000	394	390,000
180	18	131	130	102	1,000	752	7,500	563	56,000	434	430,000
200	20	151	150	112	1,100	822	8,200	623	62,000	474	470,000
220	22	161	160	122	1,200	912	9,100	683	68,000	514	510,000
240	24	181	180	132	1,300	103	10,000	753	75,000	564	560,000
270	27	201	200	152	1,500	113	11,000	823	82,000	624	620,000
300	30	221	220	162	1,600	123	12,000	913	91,000	684	680,000
330	33	241	240	182	1,800	133	13,000	104	100,000	754	750,000
360	36	271	270	202	2,000	153	15,000	114	110,000	824	820,000
390	39	301	300	222	2,200	163	16,000	124	120,000	914	910,000
430	43	331	330	242	2,400	183	18,000	134	130,000	105	1,000,000
470	47	361	360	272	2,700	203	20,000	154	150,000		
510	51	391	390	302	3,000	223	22,000	164	160,000		
560	56	431	430	332	3,300	243	24,000	184	180,000		
620	62	471	470	362	3,600	273	27,000	204	200,000		

1. Include "X" in tolerance code.



Addendum

Dual Terminator Resistor Values [Schematic 5 – 4-Digit Resistor Code]

The 752 Series part number includes the EIA Code value of the Thevenin equivalent resistances of R₁ and R₂.

The Thevenin equivalent resistance is calculated using the following formula; $R_{EQ} = R_1 * R_2 / (R_1 + R_2)$.

R1 [ohms]	R2 [ohms]	Thevenin Equivalent [ohms]	CTS Resistor Code	R1 [ohms]	R2 [ohms]	Thevenin Equivalent [ohms]	CTS Resistor Code	R1 [ohms]	R2 [ohms]	Thevenin Equivalent [ohms]	CTS Resistor Code	R1 [ohms]	R2 [ohms]	Thevenin Equivalent [ohms]	CTS Resistor Code
22	50	15	150A	118	178	71	710A	240	620	173	171C	680	1,500	468	471A
25	50	17	170A	120	120	60	600B	250	250	125	131B	715	240	180	181B
30	50	19	190A	120	150	67	670C	260	162	100	101G	750	750	375	381A
30	620	29	290A	120	180	72	720A	270	130	88	880B	750	2,300	566	571A
33	680	31	310A	120	200	75	750B	270	180	108	111C	780	390	260	261A
33	4,700	33	330A	120	220	78	780B	270	270	135	141A	820	560	333	331B
36	620	34	340A	121	195	75	750C	270	470	171	171A	1,000	1,000	500	501A
38	125	29	290B	122	253	82	820A	271	131	88	880A	1,000	1,500	600	601B
43	620	40	400A	130	210	80	800A	330	220	132	131D	1,000	2,000	667	671A
47	68	28	280A	133	154	71	710B	330	330	165	171B	1,000	2,200	688	691A
47	270	40	400B	150	150	75	750A	330	390	179	181A	1,000	3,300	767	771A
65	90	38	380A	150	180	82	820B	330	470	194	191A	1,100	820	470	471B
68	189	50	500B	150	1,000	130	131E	330	680	222	221A	1,100	2,200	733	731A
75	620	67	670A	160	240	96	960A	330	3,900	304	301A	1,200	1,200	600	601A
80	220	59	590A	160	260	99	990A	360	390	187	191B	1,500	1,500	750	751A
81	130	50	500A	160	270	100	101D	360	600	225	231A	1,500	3,300	1,031	102A
81	220	59	600C	160	440	117	121D	360	720	240	241B	2,000	1,000	667	671B
81	330	65	650B	162	260	100	101B	390	620	239	241A	2,000	2,000	1,000	102B
81	2,200	78	780A	180	220	99	101A	400	200	133	131F	2,200	3,300	1,320	132A
82	120	49	490A	180	240	103	101F	400	600	240	241C	2,200	4,400	1,467	152A
82	130	50	500D	180	270	108	111A	470	330	194	191C	2,200	5,600	1,579	162A
83	128	50	500C	180	300	113	111B	470	680	278	281C	3,000	2,000	1,200	122A
95	156	59	590B	180	390	123	121A	470	940	313	311A	3,000	6,200	2,022	202A
100	75	43	430A	180	470	130	131C	470	1,000	320	321A	3,300	4,700	1,939	192A
100	82	45	450A	182	245	104	101E	500	500	250	251A	3,900	3,300	1,788	182A
100	100	50	500E	200	100	67	670D	510	760	305	311B	4,400	2,200	1,467	152B
100	150	60	600A	200	270	115	121C	560	390	230	231B	4,700	4,700	2,350	242A
100	175	64	640A	200	1,500	176	171D	560	820	333	331A	4,700	22,000	3,873	392A
100	200	67	670B	220	220	110	111D	560	910	347	351A	5,000	5,000	2,500	252A
100	220	69	690A	220	270	121	121B	560	1,000	359	361A	6,800	22,000	5,194	522A
100	430	81	810A	220	330	132	131A	620	820	353	351B	10,000	20,000	6,667	672A
106	169	65	650A	220	470	150	151A	620	910	369	371A	10,000	51,000	8,361	842A
110	91	50	500F	220	1,800	196	201A	660	990	396	401B	50,000	100,000	33,333	333A
110	220	73	730A	240	170	100	101C	680	1,000	405	401A	360,000	390,000	187,200	194A

1. Resistor tolerances are ±2%.
2. Suffix letter in CTS Code has no significance, assigned in sequential order.

Looking for pricing, stock, or lifecycle information?

Click below to explore more details on WIN SOURCE:

-  [View 752091102GPTR7 on WIN SOURCE](#)
-  [CTS Resistor Products Information](#)

Optimize Your Supply Chain with WIN SOURCE Solutions

-  Global Sourcing Solution
-  Obsolete Management
-  Cost Control Management
-  Shortage Management
-  Alternative Solution
-  Excess Inventory Management