

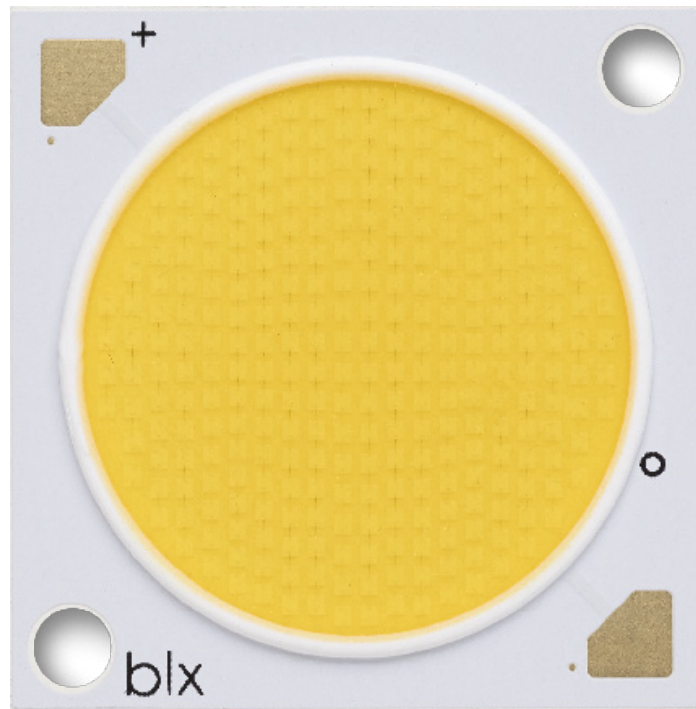

**THE DATASHEET OF  
BXRE-50G6501-B-74**





# Bridgelux® Gen 7 V22 Array Series

Product Data Sheet DS103



# Introduction

V Series

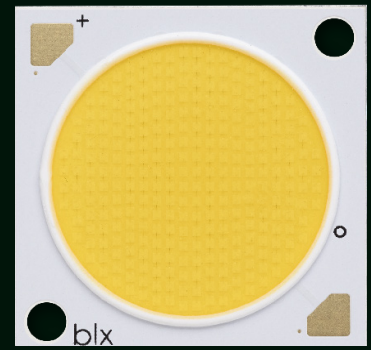

The V Series™ LED Array products deliver high quality light in a compact and cost-effective solid-state lighting package. These chip on board (CoB) arrays can be efficiently driven at twice the nominal drive current, enabling design flexibility not previously possible. This high flux density light source is designed to support a wide range of high quality, low cost directional luminaires and replacement lamps for commercial and residential applications.

The V22 LED Array is available in a variety of electrical, CCT and CRI combinations providing substantial design flexibility and energy efficiencies.

Lighting system designs incorporating these LED arrays deliver increased system level efficacy and longer service life. Typical applications include, replacement lamps, and task, accent, spot, track, wide area, security, wall pack and down lights.

Bridgelux Décor Series is our state of the art color line designed specifically for premium applications, producing unmatched LED light quality with brilliant color-rendering options and offer pleasing and inspiring lighting palettes. Bridgelux Décor Series color points are available on Vero® SE Series, Vero® Series, V Series™ and H Series™.

**Décor Series Class A** is based on human response testing, providing color points with a combined GAI and CRI metric.

**Décor Series™ Ultra** products provide a high CRI of 97 and a minimum R<sub>g</sub> value of 93, which emphasizes the reds and color tones to which the human eye is most receptive - perfect for the most luxurious retail shops and world renowned museums. Décor Series Ultra is designed as a replacement for halogen lamps.

**Décor Series™ Food** products offer color points developed to address the unique requirements of the food, grocery, and restaurant industries. Highlighting the distinctive colors and nuanced patterns found in meats and breads, the Décor Series Food products are a must have for any butcher counter or bakery.

**Décor Series™ Entertainment** products provide color points developed specifically for the healthcare and entertainment industries. The 5600K cool white color point combined with a CRI of 90 or 97 provides the bright white required by these industries.

**Décor Series™ Street and Landmark** is designed to be a direct replacement for high pressure sodium lamps.

**Décor Series™ Showcase** is the optimal solution for replacing ceramic metal halide lamps, incorporating the same pure white light with enhanced spectrum coverage and higher efficacy.

## Features

- Efficacy of 160 lm/W typical
- Compact high flux density light source
- Uniform high quality illumination
- Minimum 65, 70, 80, 90 and 95 CRI options
- Streamlined thermal path
- ENERGY STAR® / ANSI compliant color binning structure with 2, 3 and 4 SDCM options
- More energy efficient than incandescent, halogen and fluorescent lamps
- Low voltage DC operation
- Instant light with unlimited dimming
- V<sub>f</sub> bin code backside marking

## Benefits

- Enhanced optical control
- Clean white light without pixilation
- High quality true color reproduction
- Significantly reduced thermal resistance and increased operating temperatures
- Uniform consistent white light
- Lower operating costs
- Easy to use with daylight and motion detectors to enable increased energy savings
- Reduced maintenance costs
- Environmentally friendly, no disposal issue



# Contents

Product Feature Map	2
Product Nomenclature	2
Product Selection Guide	3
Performance at Commonly Used Drive Currents	9
Electrical Characteristics	17
Eye Safety	18
Absolute Maximum Ratings	19
Performance Curves	20
Typical Radiation Pattern	24
Typical Color Spectrum	25
Mechanical Dimensions	26
Color Binning Information	27
Packaging and Labeling	28
Design Resources	30
Precautions	30
Disclaimers	30
About Bridgelux	31

# Product Feature Map

Bridgelux arrays are fully engineered devices that provide consistent thermal and optical performance on an engineered mechanical platform. The V Series arrays are the most compact chip-on-board devices across all of

Bridgelux's LED Array products. The arrays incorporate several features to simplify design integration and assembly. Please visit [www.bridgelux.com](http://www.bridgelux.com) for more information on the V Series family of products.

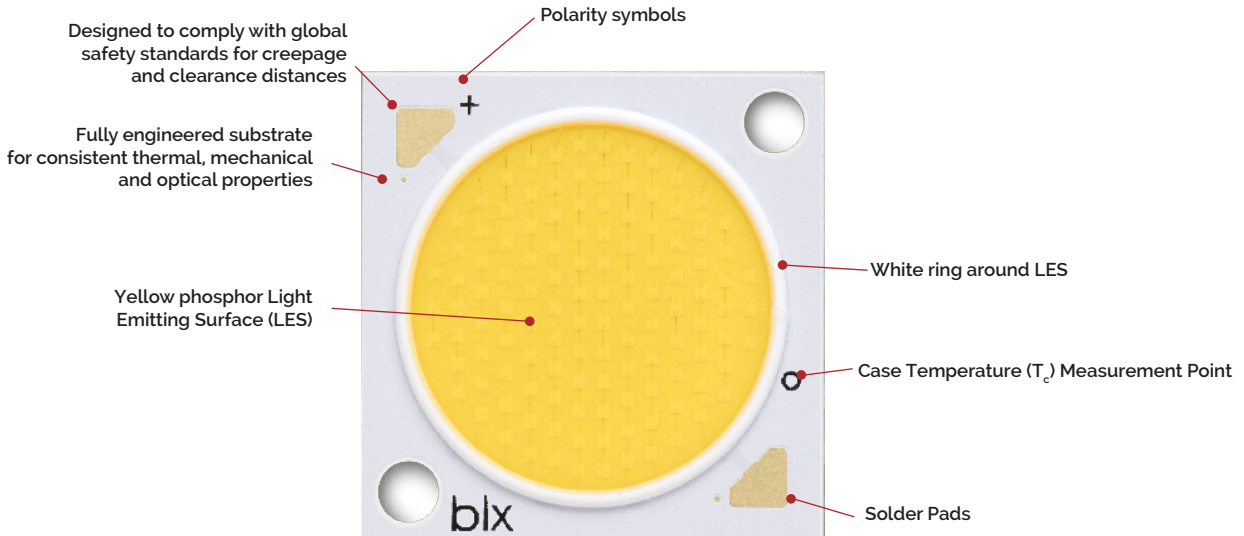

Note: Part number and lot codes are scribed on back of array

## Product Nomenclature

The part number designation for Bridgelux V Series LED arrays is explained as follows:

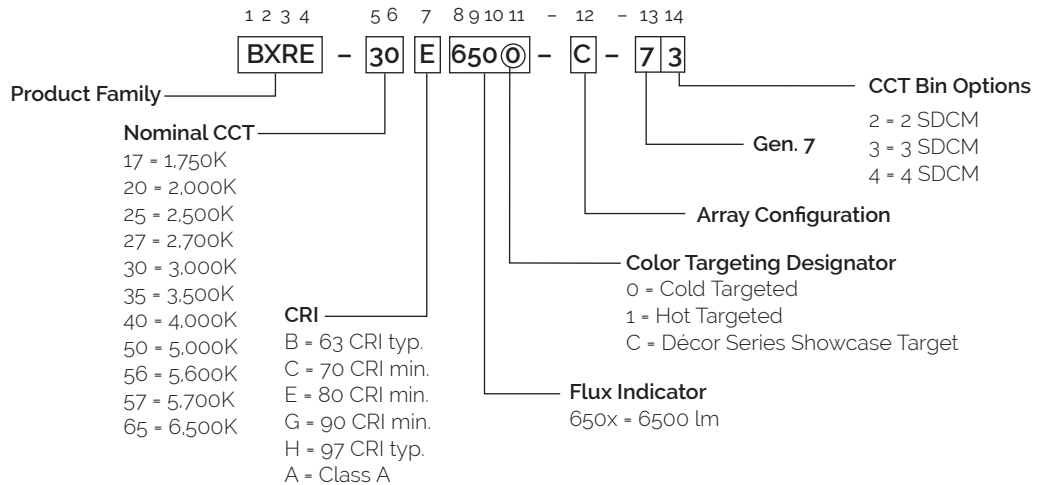

# Product Selection Guide

The following product configurations are available:

**Table 1:** Selection Guide, Pulsed Measurement Data ( $T_j = T_c = 25^\circ\text{C}$ )

Part Number	Nominal CCT <sup>1</sup> (K)	CRI <sup>2</sup>	Nominal Drive Current <sup>3</sup> (mA)	Typical Pulsed Flux <sup>4,5,6</sup> $T_c = 25^\circ\text{C}$ (lm)	Minimum Pulsed Flux <sup>6,7</sup> $T_c = 25^\circ\text{C}$ (lm)	Typical $V_f$ (V)	Typical Power (W)	Typical Efficacy (lm/W)
BXRE-17E6500-D-74	1750	80	1400	4340	3906	35.0	49.0	89
BXRE-20B6501-C-73	2000	65	1440	11183	10065	52.0	74.9	149
BXRE-20B6501-D-73	2000	65	1400	7318	6586	35.0	49.0	149
BXRE-25E6500-D-74	2500	80	1400	7015	6314	35.0	49.0	143
BXRE-27E6500-B-7x	2700	80	1170	9337	8403	52.0	60.8	153
BXRE-27E6500-C-7x	2700	80	1440	11492	10343	52.0	74.9	153
BXRE-27E6500-D-7x	2700	80	1400	7520	6768	35.0	49.0	153
BXRE-27G65H0-B-7x	2700	90	1170	8092	7283	52.0	60.8	133
BXRE-27G65H0-C-7x	2700	90	1440	9959	8963	52.0	74.9	133
BXRE-27G65H0-D-7x	2700	90	1400	6517	5865	35.0	49.0	133
BXRE-27G6500-B-7x	2700	90	1170	7770	6993	52.0	60.8	128
BXRE-27G6500-C-7x	2700	90	1440	9564	8607	52.0	74.9	128
BXRE-27G6500-D-7x	2700	90	1400	6258	5632	35.0	49.0	128
BXRE-27H6500-D-7x	2700	97	1400	5451	4906	35.0	49.0	111
BXRE-30C6501-B-74	3000	70	1170	10708	9637	52.0	60.8	176
BXRE-30C6501-C-74	3000	70	1440	13179	11861	52.0	74.9	176
BXRE-30C6501-D-74	3000	70	1400	8624	7762	35.0	49.0	176
BXRE-30E6500-B-7x <sup>10</sup>	3000	80	1170	9713	8742	52.0	60.8	160
BXRE-30E6500-C-7x <sup>10</sup>	3000	80	1440	11955	10759	52.0	74.9	160
BXRE-30E6500-D-7x <sup>10</sup>	3000	80	1400	7823	7041	35.0	49.0	160
BXRE-30G65H0-B-7x	3000	90	1170	8457	7611	52.0	60.8	139
BXRE-30G65H0-C-7x	3000	90	1440	10408	9367	52.0	74.9	139
BXRE-30G65H0-D-7x	3000	90	1400	6811	6130	35.0	49.0	139
BXRE-30G6500-B-7x	3000	90	1170	8084	7275	52.0	60.8	133
BXRE-30G6500-C-7x	3000	90	1440	9949	8954	52.0	74.9	133
BXRE-30G6500-D-7x	3000	90	1400	6511	5860	35.0	49.0	133
BXRE-30G650C-D-73	3000	90	1400	6056	5451	35.0	49.0	124
BXRE-30H6500-D-7x	3000	97	1400	5804	5224	35.0	49.0	118
BXRE-35E6500-B-7x <sup>10</sup>	3500	80	1170	10026	9024	52.0	60.8	165
BXRE-35E6500-C-7x <sup>10</sup>	3500	80	1440	12340	11106	52.0	74.9	165
BXRE-35E6500-D-7x <sup>10</sup>	3500	80	1400	8075	7268	35.0	49.0	165
BXRE-35G6500-B-7x	3500	90	1170	8334	7501	52.0	60.8	137

Notes for Table 1:

- Nominal CCT as defined by ANSI C78.377-2011. Products with a CCT of 5000K-6500K are hot targeted to  $T_c = 85^\circ\text{C}$ .
- CRI values are typical for Décor Series Ultra, Décor Series Street and Landmark and Décor Series Class A products. CRI values are minimums for all other products. Minimum R<sub>g</sub> value for 80 CRI products is 0, the minimum R<sub>g</sub> values for 90 CRI products is 50, the minimum R<sub>g</sub> values for 97 CRI products is 93. Bridgelux maintains a  $\pm 3$  tolerance on R<sub>g</sub> values.
- Drive current is referred to as nominal drive current.
- Products tested under pulsed condition (10ms pulse width) at nominal test current where  $T_j$  (junction temperature) -  $T_c$  (case temperature) =  $25^\circ\text{C}$ .
- Typical performance values are provided as a reference only and are not a guarantee of performance.
- Bridgelux maintains a  $\pm 7\%$  tolerance on flux measurements.
- Minimum flux values at the nominal test current are guaranteed by 100% test.
- Nominal CCT is defined by the Lighting Research Center's Class A definition. The center of the Class A color bin is on the corresponding isothermal line.
- GAI value is 80. To help ensure optimal fixture level performance, GAI is measured at the fixture level, on axis, at a case temperature of  $70^\circ\text{C}$ . GAI may vary depending on fixture design and performance.
- SKUs meet DLC premium (Outdoor Mid Output) requirements under certain system level conditions.

# Product Selection Guide

The following product configurations are available:

**Table 1:** Selection Guide, Pulsed Measurement Data ( $T_j = T_c = 25^\circ\text{C}$ )

Part Number	Nominal CCT <sup>1</sup> (K)	CRI <sup>2</sup>	Nominal Drive Current <sup>3</sup> (mA)	Typical Pulsed Flux <sup>4,5,6</sup> $T_c = 25^\circ\text{C}$ (lm)	Minimum Pulsed Flux <sup>6,7</sup> $T_c = 25^\circ\text{C}$ (lm)	Typical $V_f$ (V)	Typical Power (W)	Typical Efficacy (lm/W)
BXRE-35G6500-C-7x	3500	90	1440	10258	9232	52.0	74.9	137
BXRE-35G6500-D-7x	3500	90	1400	6713	6041	35.0	49.0	137
BXRE-35A6501-D-73 <sup>8,9</sup>	3500	93	1400	6321	5689	35.0	49.0	129
BXRE-40C6501-B-74	4000	70	1170	10966	9870	52.0	60.8	180
BXRE-40C6501-C-74	4000	70	1440	13497	12147	52.0	74.9	180
BXRE-40C6501-D-74	4000	70	1400	8832	7949	35.0	49.0	180
BXRE-40E6500-B-7x <sup>10</sup>	4000	80	1170	10089	9080	52.0	60.8	166
BXRE-40E6500-C-7x <sup>10</sup>	4000	80	1440	12417	11176	52.0	74.9	166
BXRE-40E6500-D-7x <sup>10</sup>	4000	80	1400	8126	7313	35.0	49.0	166
BXRE-40G6500-B-7x	4000	90	1170	8648	7783	52.0	60.8	142
BXRE-40G6500-C-7x	4000	90	1440	10643	9579	52.0	74.9	142
BXRE-40G6500-D-7x	4000	90	1400	6965	6268	35.0	49.0	142
BXRE-40H6500-D-73	4000	97	1400	5978	5380	35.0	49.0	122
BXRE-50C6501-B-7x <sup>10</sup>	5000	70	1170	11092	9983	52.0	60.8	182
BXRE-50C6501-C-7x <sup>10</sup>	5000	70	1440	13651	12286	52.0	74.9	182
BXRE-50C6501-D-7x <sup>10</sup>	5000	70	1400	8933	8040	35.0	49.0	182
BXRE-50E6501-B-7x <sup>10</sup>	5000	80	1170	10402	9362	52.0	60.8	171
BXRE-50E6501-C-7x <sup>10</sup>	5000	80	1440	12803	11523	52.0	74.9	171
BXRE-50E6501-D-7x <sup>10</sup>	5000	80	1400	8378	7540	35.0	49.0	171
BXRE-50G6501-B-7x	5000	90	1170	8836	7952	52.0	60.8	145
BXRE-50G6501-C-7x	5000	90	1440	10875	9787	52.0	74.9	145
BXRE-50G6501-D-7x	5700	90	1400	7116	6405	35.0	49.0	145
BXRE-56G6501-D-7x	5600	90	1400	7470	6723	35.0	49.0	152
BXRE-57C6501-B-7x <sup>10</sup>	5700	70	1170	10716	9644	52.0	60.8	176
BXRE-57C6501-C-7x <sup>10</sup>	5700	70	1440	13189	11870	52.0	74.9	176
BXRE-57C6501-D-7x <sup>10</sup>	5700	70	1400	8630	7767	35.0	49.0	176
BXRE-57E6501-B-7x <sup>10</sup>	5700	80	1170	10282	9254	52.0	60.8	169
BXRE-57E6501-C-7x <sup>10</sup>	5700	80	1440	12655	11389	52.0	74.9	169
BXRE-57E6501-D-7x <sup>10</sup>	6500	80	1400	8281	7453	35.0	49.0	169
BXRE-65C6501-B-7x <sup>10</sup>	6500	70	1170	10904	9813	52.0	60.8	179
BXRE-65C6501-C-7x <sup>10</sup>	6500	70	1440	13420	12078	52.0	74.9	179
BXRE-65C6501-D-7x <sup>10</sup>	6500	70	1400	8782	7904	35.0	49.0	179

Notes for Table 1:

- Nominal CCT as defined by ANSI C78.377-2011. Products with a CCT of 5000K-6500K are hot targeted to  $T_c = 85^\circ\text{C}$ .
- CRI values are typical for Décor Series Ultra, Décor Series Street and Landmark and Décor Series Class A products. CRI values are minimums for all other products. Minimum R<sub>g</sub> value for 80 CRI products is 0, the minimum R<sub>g</sub> values for 90 CRI products is 50, the minimum R<sub>g</sub> values for 97 CRI products is 93. Bridgelux maintains a  $\pm 3$  tolerance on R<sub>g</sub> values.
- Drive current is referred to as nominal drive current.
- Products tested under pulsed condition (10ms pulse width) at nominal test current where  $T_j$  (junction temperature) =  $T_c$  (case temperature) =  $25^\circ\text{C}$ .
- Typical performance values are provided as a reference only and are not a guarantee of performance.
- Bridgelux maintains a  $\pm 7\%$  tolerance on flux measurements.
- Minimum flux values at the nominal test current are guaranteed by 100% test.
- Nominal CCT is defined by the Lighting Research Center's Class A definition. The center of the Class A color bin is on the corresponding isothermal line.
- GAI value is 80. To help ensure optimal fixture level performance, GAI is measured at the fixture level, on axis, at a case temperature of  $70^\circ\text{C}$ . GAI may vary depending on fixture design and performance.
- SKUs meet DLC premium (Outdoor Mid Output) requirements under certain system level conditions.

# Product Selection Guide

The following product configurations are available:

**Table 1:** Selection Guide, Pulsed Measurement Data ( $T_j = T_c = 25^\circ\text{C}$ )

Part Number	Nominal CCT <sup>1</sup> (K)	CRI <sup>2</sup>	Nominal Drive Current <sup>3</sup> (mA)	Typical Pulsed Flux <sup>4,5,6</sup> $T_c = 25^\circ\text{C}$ (lm)	Minimum Pulsed Flux <sup>6,7</sup> $T_c = 25^\circ\text{C}$ (lm)	Typical $V_f$ (V)	Typical Power (W)	Typical Efficacy (lm/W)
BXRE-65E6501-B-7x <sup>10</sup>	6500	80	1170	10464	9418	52.0	60.8	172
BXRE-65E6501-C-7x <sup>10</sup>	6500	80	1440	12879	11591	52.0	74.9	172
BXRE-65E6501-D-7x <sup>10</sup>	6500	80	1400	8428	7585	35.0	49.0	172

Notes for Table 1:

- Nominal CCT as defined by ANSI C78.377-2011. Products with a CCT of 5000K-6500K are hot targeted to  $T_c = 85^\circ\text{C}$ .
- CRI values are typical for Décor Series Ultra, Décor Series Street and Landmark and Décor Series Class A products. CRI values are minimums for all other products. Minimum R<sub>g</sub> value for 80 CRI products is 0, the minimum R<sub>g</sub> values for 90 CRI products is 50, the minimum R<sub>g</sub> values for 97 CRI products is 93. Bridgelux maintains a  $\pm 3$  tolerance on R<sub>g</sub> values.
- Drive current is referred to as nominal drive current.
- Products tested under pulsed condition (10ms pulse width) at nominal test current where  $T_j$  (junction temperature) =  $T_c$  (case temperature) =  $25^\circ\text{C}$ .
- Typical performance values are provided as a reference only and are not a guarantee of performance.
- Bridgelux maintains a  $\pm 7\%$  tolerance on flux measurements.
- Minimum flux values at the nominal test current are guaranteed by 100% test.
- Nominal CCT is defined by the Lighting Research Center's Class A definition. The center of the Class A color bin is on the corresponding isothermal line.
- GAI value is 80. To help ensure optimal fixture level performance, GAI is measured at the fixture level, on axis, at a case temperature of  $70^\circ\text{C}$ . GAI may vary depending on fixture design and performance.
- SKUs meet DLC premium (Outdoor Mid Output) requirements under certain system level conditions.

# Product Selection Guide

**Table 2:** Selection Guide, Stabilized DC Performance ( $T_c = 70^\circ\text{C}$ )<sup>7,8</sup>

Part Number	Nominal CCT <sup>1</sup> (K)	GAI <sup>2</sup>	CRI <sup>3</sup>	Nominal Drive Current <sup>4</sup> (mA)	Typical DC Flux <sup>5,6</sup> $T_c = 70^\circ\text{C}$ (lm)	Minimum DC Flux <sup>8,9</sup> $T_c = 70^\circ\text{C}$ (lm)	Typical $V_f$ (V)	Typical Power (W)	Typical Efficacy (lm/W)
BXRE-35A6501-D-73	3500	80	93	1400	5879	5291	33.4	46.8	126

Notes for Table 2:

- Nominal CCT is defined by the Lighting Research Center's Class A definition. The center of the Class A color bin is on the corresponding isothermal line.
- To help ensure optimal fixture level performance, GAI is measured at the fixture level, on axis, at a case temperature of  $70^\circ\text{C}$ . GAI may vary depending on fixture design and performance.
- All CRI values are measured at  $T_j = T_c = 25^\circ\text{C}$ . CRI Values are specified as typical.
- Drive current is referred to as nominal drive current.
- Typical performance values are provided as a reference only and are not a guarantee of performance.
- Bridgelux maintains a  $\pm 7\%$  tolerance on flux measurements.
- Typical stabilized DC performance values are provided as reference only and are not a guarantee of performance.
- Typical performance is estimated based on operation under DC (direct current) with LED array mounted onto a heat sink with thermal interface material and the case temperature maintained at specified temperature. Based on Bridgelux test setup, values may vary depending on the thermal design of the luminaire and/or the exposed environment to which the product is subjected.
- Minimum flux values at elevated temperatures are provided for reference only and are not guaranteed by 100% production testing. Based on Bridgelux test setup, values may vary depending on the thermal design of the luminaire and/or the exposed environment to which the product is subjected.

# Product Selection Guide

**Table 3:** Selection Guide, Stabilized DC Performance ( $T_c = 85^\circ\text{C}$ )<sup>4,5</sup>

Part Number	Nominal CCT <sup>1</sup> (K)	CRI <sup>2</sup>	Nominal Drive Current <sup>3</sup> (mA)	Typical DC Flux <sup>4,5</sup> $T_c = 85^\circ\text{C}$ (lm)	Minimum DC Flux <sup>6</sup> $T_c = 85^\circ\text{C}$ (lm)	Typical $V_f$ (V)	Typical Power (W)	Typical Efficacy (lm/W)
BXRE-17E6500-D-74	1750	80	1400	3906	3516	334	46.8	84
BXRE-20B6501-C-73	2000	65	1440	10065	9058	50.7	73.0	138
BXRE-20B6501-D-73	2000	65	1400	6586	5928	334	46.8	141
BXRE-25E6500-D-74	2500	80	1400	6314	5682	334	46.8	135
BXRE-27E6500-B-7x	2700	80	1170	8403	7563	50.7	59.3	142
BXRE-27E6500-C-7x	2700	80	1440	10343	9308	50.7	73.0	142
BXRE-27E6500-D-7x	2700	80	1400	6768	6091	334	46.8	145
BXRE-27G65H0-B-7x	2700	90	1170	7283	6554	50.7	59.3	123
BXRE-27G65H0-C-7x	2700	90	1440	8963	8067	50.7	73.0	123
BXRE-27G65H0-D-7x	2700	90	1400	5865	5279	334	46.8	125
BXRE-27G6500-B-7x	2700	90	1170	6993	6294	50.7	59.3	118
BXRE-27G6500-C-7x	2700	90	1440	8607	7747	50.7	73.0	118
BXRE-27G6500-D-7x	2700	90	1400	5632	5069	334	46.8	120
BXRE-27H6500-D-7x	2700	97	1400	4906	4415	334	46.8	105
BXRE-30C6501-B-74	3000	70	1170	9637	8673	50.7	59.3	163
BXRE-30C6501-C-74	3000	70	1440	11861	10675	50.7	73.0	163
BXRE-30C6501-D-74	3000	70	1400	7762	6985	334	46.8	166
BXRE-30E6500-B-7x	3000	80	1170	8742	7868	50.7	59.3	147
BXRE-30E6500-C-7x	3000	80	1440	10759	9683	50.7	73.0	147
BXRE-30E6500-D-7x	3000	80	1400	7041	6337	334	46.8	151
BXRE-30G65H0-B-7x	3000	90	1170	7611	6850	50.7	59.3	128
BXRE-30G65H0-C-7x	3000	90	1440	9367	8431	50.7	73.0	128
BXRE-30G65H0-D-7x	3000	90	1400	6130	5517	334	46.8	131
BXRE-30G6500-B-7x	3000	90	1170	7275	6548	50.7	59.3	123
BXRE-30G6500-C-7x	3000	90	1440	8954	8059	50.7	73.0	123
BXRE-30G6500-D-7x	3000	90	1400	5860	5274	334	46.8	125
BXRE-30G650C-D-73	3000	90	1400	5451	4906	334	46.8	117
BXRE-30H6500-D-7x	3000	97	1400	5224	4701	334	46.8	112
BXRE-35E6500-B-7x	3500	80	1170	9024	8121	50.7	59.3	152
BXRE-35E6500-C-7x	3500	80	1440	11106	9996	50.7	73.0	152
BXRE-35E6500-D-7x	3500	80	1400	7268	6541	334	46.8	155
BXRE-35G6500-B-7x	3500	90	1170	7501	6751	50.7	59.3	127

Notes for Table 3:

- Nominal CCT as defined by ANSI C78.377-2011. Products with a CCT of 5000K-6500K are hot targeted to  $T_c = 85^\circ\text{C}$ .
- All CRI values are measured at  $T_c = 25^\circ\text{C}$ . CRI values are typical for Décor Series Ultra, Décor Series Street and Landmark and Décor Series Class A products. CRI values are minimums for all other products. Minimum R<sub>g</sub> value for 80 CRI products is 0, the minimum R<sub>g</sub> values for 90 CRI products is 50, the minimum R<sub>g</sub> values for 97 CRI products is 93. Bridgelux maintains a  $\pm 3$  tolerance on R<sub>g</sub> values.
- Drive current is referred to as nominal drive current.
- Typical stabilized DC performance values are provided as reference only and are not a guarantee of performance.
- Typical performance is estimated based on operation under DC (direct current) with LED array mounted onto a heat sink with thermal interface material and the case temperature maintained at  $85^\circ\text{C}$ . Based on Bridgelux test setup, values may vary depending on the thermal design of the luminaire and/or the exposed environment to which the product is subjected.
- Minimum flux values at elevated temperatures are provided for reference only and are not guaranteed by 100% production testing. Based on Bridgelux test setup, values may vary depending on the thermal design of the luminaire and/or the exposed environment to which the product is subjected.
- Nominal CCT is defined by the Lighting Research Center's Class A definition. The center of the Class A color bin is on the corresponding isothermal line.
- GAI value is 80. To help ensure optimal fixture level performance, GAI is measured at the fixture level, on axis, at a case temperature of  $70^\circ\text{C}$ . GAI may vary depending on fixture design and performance.

# Product Selection Guide

**Table 3:** Selection Guide, Stabilized DC Performance ( $T_c = 85^\circ\text{C}$ )<sup>4,5</sup> (continued)

Part Number	Nominal CCT <sup>1</sup> (K)	CRI <sup>2</sup>	Nominal Drive Current <sup>3</sup> (mA)	Typical DC Flux <sup>4,5</sup> $T_c = 85^\circ\text{C}$ (lm)	Minimum DC Flux <sup>6</sup> $T_c = 85^\circ\text{C}$ (lm)	Typical $V_f$ (V)	Typical Power (W)	Typical Efficacy (lm/W)
BXRE-35G6500-C-7x	3500	90	1440	9232	8309	50.7	73.0	127
BXRE-35G6500-D-7x	3500	90	1400	6041	5437	33.4	46.8	129
BXRE-35A6501-D-73 <sup>7,8</sup>	3500	93	1400	5689	5120	33.4	46.8	122
BXRE-40C6501-B-74	4000	70	1170	9870	8883	50.7	59.3	166
BXRE-40C6501-C-74	4000	70	1440	12147	10933	50.7	73.0	166
BXRE-40C6501-D-74	4000	70	1400	7949	7154	33.4	46.8	170
BXRE-40E6500-B-7x	4000	80	1170	9080	8172	50.7	59.3	153
BXRE-40E6500-C-7x	4000	80	1440	11176	10058	50.7	73.0	153
BXRE-40E6500-D-7x	4000	80	1400	7313	6582	33.4	46.8	156
BXRE-40G6500-B-7x	4000	90	1170	7783	7005	50.7	59.3	131
BXRE-40G6500-C-7x	4000	90	1440	9579	8621	50.7	73.0	131
BXRE-40G6500-D-7x	4000	90	1400	6268	5642	33.4	46.8	134
BXRE-40H6500-D-73	4000	97	1400	5380	4842	33.4	46.8	115
BXRE-50C6501-B-7x	5000	70	1170	9983	8984	50.7	59.3	168
BXRE-50C6501-C-7x	5000	70	1440	12286	11058	50.7	73.0	168
BXRE-50C6501-D-7x	5000	70	1400	8040	7236	33.4	46.8	172
BXRE-50E6501-B-7x	5000	80	1170	9362	8426	50.7	59.3	158
BXRE-50E6501-C-7x	5000	80	1440	11523	10370	50.7	73.0	158
BXRE-50E6501-D-7x	5000	80	1400	7540	6786	33.4	46.8	161
BXRE-50G6501-B-7x	5000	90	1170	7952	7157	50.7	59.3	134
BXRE-50G6501-C-7x	5000	90	1440	9787	8809	50.7	73.0	134
BXRE-50G6501-D-7x	5700	90	1400	6405	5764	33.4	46.8	137
BXRE-56G6501-D-7x	5600	90	1400	6723	6050	33.4	46.8	144
BXRE-57C6501-B-7x	5700	70	1170	9644	8680	50.7	59.3	163
BXRE-57C6501-C-7x	5700	70	1440	11870	10683	50.7	73.0	163
BXRE-57C6501-D-7x	5700	70	1400	7767	6991	33.4	46.8	166
BXRE-57E6501-B-7x	5700	80	1170	9254	8328	50.7	59.3	156
BXRE-57E6501-C-7x	5700	80	1440	11389	10250	50.7	73.0	156
BXRE-57E6501-D-7x	6500	80	1400	7453	6708	33.4	46.8	159
BXRE-65C6501-B-7x	6500	70	1170	9813	8832	50.7	59.3	166
BXRE-65C6501-C-7x	6500	70	1440	12078	10870	50.7	73.0	166
BXRE-65C6501-D-7x	6500	70	1400	7904	7113	33.4	46.8	169
BXRE-65E6501-B-7x	6500	80	1170	9418	8476	50.7	59.3	159
BXRE-65E6501-C-7x	6500	80	1440	11591	10432	50.7	73.0	159
BXRE-65E6501-D-7x	6500	80	1400	7585	6827	33.4	46.8	162

Notes for Table 3:

- Nominal CCT as defined by ANSI C78.377-2011. Products with a CCT of 5000K-6500K are hot targeted to  $T_c = 85^\circ\text{C}$ .
- All CRI values are measured at  $T_c = T_a = 25^\circ\text{C}$ . CRI values are typical for Décor Series Ultra, Décor Series Street and Landmark and Décor Series Class A products. CRI values are minimums for all other products. Minimum R<sub>g</sub> value for 80 CRI products is 0, the minimum R<sub>g</sub> values for 90 CRI products is 50, the minimum R<sub>g</sub> values for 97 CRI products is 93. Bridgelux maintains a  $\pm 3$  tolerance on R<sub>g</sub> values.
- Drive current is referred to as nominal drive current.
- Typical stabilized DC performance values are provided as reference only and are not a guarantee of performance.
- Typical performance is estimated based on operation under DC (direct current) with LED array mounted onto a heat sink with thermal interface material and the case temperature maintained at  $85^\circ\text{C}$ . Based on Bridgelux test setup, values may vary depending on the thermal design of the luminaire and/or the exposed environment to which the product is subjected.
- Minimum flux values at elevated temperatures are provided for reference only and are not guaranteed by 100% production testing. Based on Bridgelux test setup, values may vary depending on the thermal design of the luminaire and/or the exposed environment to which the product is subjected.
- Nominal CCT is defined by the Lighting Research Center's Class A definition. The center of the Class A color bin is on the corresponding isothermal line.
- GAI value is 80. To help ensure optimal fixture level performance, GAI is measured at the fixture level, on axis, at a case temperature of  $70^\circ\text{C}$ . GAI may vary depending on fixture design and performance.

# Performance at Commonly Used Drive Currents

V Series LED arrays are tested to the specifications shown using the nominal drive currents in Table 1. V Series may also be driven at other drive currents dependent on specific application design requirements. The performance at any drive current can be derived from the current vs. voltage characteristics shown in Figures 1, 2 & 3 and the flux vs. current characteristics shown in Figures 4, 5 & 6. The performance at commonly used drive currents is summarized in Table 4.

**Table 4:** Product Performance at Commonly Used Drive Currents

Part Number	CRI	Drive Current <sup>1</sup> (mA)	Typical $V_f$ $T_c = 25^\circ\text{C}$ (V)	Typical Power $T_c = 25^\circ\text{C}$ (W)	Typical Flux <sup>2</sup> $T_c = 25^\circ\text{C}$ (lm)	Typical DC Flux <sup>3</sup> $T_c = 85^\circ\text{C}$ (lm)	Typical Efficacy $T_c = 25^\circ\text{C}$ (lm/W)
BXRE-17E6500-D-74	80	700	33.2	23.3	2241	2065	96
		1050	34.2	35.9	3301	3028	92
		<b>1400</b>	<b>35.0</b>	<b>49.0</b>	<b>4340</b>	<b>3906</b>	<b>89</b>
		2100	36.4	76.5	6276	5637	82
		2800	37.7	105.6	8082	7185	77
BXRE-20B6501-C-73	65	720	49.6	35.7	6243	5301	175
		960	50.5	48.5	7941	6946	164
		<b>1440</b>	<b>52.0</b>	<b>74.9</b>	<b>11183</b>	<b>10065</b>	<b>149</b>
		2160	54.2	117.0	15660	14397	134
		2880	55.9	161.1	19673	18249	122
BXRE-20B6501-D-73	65	700	33.2	23.3	3778	3482	162
		1050	34.2	35.9	5566	5105	155
		<b>1400</b>	<b>35.0</b>	<b>49.0</b>	<b>7318</b>	<b>6586</b>	<b>149</b>
		2100	36.4	76.5	10581	9505	138
		2800	37.7	105.6	13626	12114	129
BXRE-25E6500-D-74	80	700	33.2	23.3	3622	3337	156
		1050	34.2	35.9	5336	4893	148
		<b>1400</b>	<b>35.0</b>	<b>49.0</b>	<b>7015</b>	<b>6314</b>	<b>143</b>
		2100	36.4	76.5	10143	9112	133
		2800	37.7	105.6	13062	11612	124
BXRE-27E6500-B-7X	80	585	49.6	29.0	4996	4622	172
		780	50.5	39.4	6486	5930	165
		<b>1170</b>	<b>52.0</b>	<b>60.8</b>	<b>9337</b>	<b>8403</b>	<b>153</b>
		1755	54.3	95.3	13294	11828	140
		2340	56.2	131.5	16868	14856	128
BXRE-27E6500-C-7X	80	720	49.6	35.7	6415	5448	179
		960	50.5	48.5	8160	7138	168
		<b>1440</b>	<b>52.0</b>	<b>74.9</b>	<b>11492</b>	<b>10343</b>	<b>153</b>
		2160	54.2	117.0	16092	14794	138
		2880	55.9	161.1	20216	18752	125
BXRE-27E6500-D-7X	80	700	33.2	23.3	3882	3578	167
		1050	34.2	35.9	5720	5246	159
		<b>1400</b>	<b>35.0</b>	<b>49.0</b>	<b>7520</b>	<b>6768</b>	<b>153</b>
		2100	36.4	76.5	10873	9767	142
		2800	37.7	105.6	14002	12448	133
BXRE-27G65H0-B-7X	90	585	49.6	29.0	4330	4006	149
		780	50.5	39.4	5621	5139	143
		<b>1170</b>	<b>52.0</b>	<b>60.8</b>	<b>8092</b>	<b>7283</b>	<b>133</b>
		1755	54.3	95.3	11521	10250	121
		2340	56.2	131.5	14618	12874	111

Notes for Table 4:

1. Alternate drive currents are provided for reference only and are not a guarantee of performance.
2. Bridgelux maintains a  $\pm 7\%$  tolerance on flux measurements.
3. Typical stabilized DC performance values are provided as reference only and are not a guarantee of performance.

# Performance at Commonly Used Drive Currents

**Table 4:** Product Performance at Commonly Used Drive Currents (Continued)

Part Number	CRI	Drive Current <sup>1</sup> (mA)	Typical V <sub>f</sub> T <sub>c</sub> = 25°C (V)	Typical Power T <sub>c</sub> = 25°C (W)	Typical Flux <sup>2</sup> T <sub>c</sub> = 25°C (lm)	Typical DC Flux <sup>3</sup> T <sub>c</sub> = 85°C (lm)	Typical Efficacy T <sub>c</sub> = 25°C (lm/W)
BXRE-27G65H0-C-7x	90	720	49.6	35.7	5559	4721	156
		960	50.5	48.5	7072	6186	146
		<b>1440</b>	<b>52.0</b>	<b>74.9</b>	<b>9959</b>	<b>8963</b>	<b>133</b>
		2160	54.2	117.0	13946	12821	119
		2880	55.9	161.1	17520	16251	109
BXRE-27G65H0-D-7x	90	700	33.2	23.3	3364	3100	145
		1050	34.2	35.9	4957	4546	138
		<b>1400</b>	<b>35.0</b>	<b>49.0</b>	<b>6517</b>	<b>5865</b>	<b>133</b>
		2100	36.4	76.5	9422	8464	123
		2800	37.7	105.6	12134	10787	115
BXRE-27G6500-B-7x	90	585	49.6	29.0	4158	3847	143
		780	50.5	39.4	5398	4935	137
		<b>1170</b>	<b>52.0</b>	<b>60.8</b>	<b>7770</b>	<b>6993</b>	<b>128</b>
		1755	54.3	95.3	11064	9843	116
		2340	56.2	131.5	14038	12363	107
BXRE-27G6500-C-7x	90	720	49.6	35.7	5338	4534	149
		960	50.5	48.5	6791	5940	140
		<b>1440</b>	<b>52.0</b>	<b>74.9</b>	<b>9564</b>	<b>8607</b>	<b>128</b>
		2160	54.2	117.0	13392	12312	114
		2880	55.9	161.1	16824	15606	104
BXRE-27G6500-D-7x	90	700	33.2	23.3	3231	2977	139
		1050	34.2	35.9	4760	4365	132
		<b>1400</b>	<b>35.0</b>	<b>49.0</b>	<b>6258</b>	<b>5632</b>	<b>128</b>
		2100	36.4	76.5	9048	8128	118
		2800	37.7	105.6	11653	10359	110
BXRE-27H6500-D-7x	97	700	33.2	23.3	2814	2593	121
		1050	34.2	35.9	4146	3802	115
		<b>1400</b>	<b>35.0</b>	<b>49.0</b>	<b>5451</b>	<b>4906</b>	<b>111</b>
		2100	36.4	76.5	7881	7080	103
		2800	37.7	105.6	10149	9023	96
BXRE-30C6501-B-74	70	585	49.6	29.0	5977	5076	206
		780	50.5	39.4	7603	6651	193
		<b>1170</b>	<b>52.0</b>	<b>60.8</b>	<b>10708</b>	<b>9637</b>	<b>176</b>
		1755	54.3	95.3	14994	13785	157
		2340	56.2	131.5	18837	17473	143
BXRE-30C6501-C-74	70	720	49.6	35.7	6804	6270	190
		960	50.5	48.5	10024	9193	207
		<b>1440</b>	<b>52.0</b>	<b>74.9</b>	<b>13179</b>	<b>11861</b>	<b>176</b>
		2160	54.2	117.0	19054	17117	163
		2880	55.9	161.1	24539	21815	152
BXRE-30C6501-D-74	70	700	33.2	23.3	4452	4103	191
		1050	34.2	35.9	6559	6016	182
		<b>1400</b>	<b>35.0</b>	<b>49.0</b>	<b>8624</b>	<b>7762</b>	<b>176</b>
		2100	36.4	76.5	12469	11201	163
		2800	37.7	105.6	16058	14275	152

Notes for Table 4:

1. Alternate drive currents are provided for reference only and are not a guarantee of performance.
2. Bridgelux maintains a ± 7% tolerance on flux measurements.
3. Typical stabilized DC performance values are provided as reference only and are not a guarantee of performance.

# Performance at Commonly Used Drive Currents

**Table 4:** Product Performance at Commonly Used Drive Currents (Continued)

Part Number	CRI	Drive Current <sup>1</sup> (mA)	Typical V <sub>f</sub> T <sub>c</sub> = 25°C (V)	Typical Power T <sub>c</sub> = 25°C (W)	Typical Flux <sup>2</sup> T <sub>c</sub> = 25°C (lm)	Typical DC Flux <sup>3</sup> T <sub>c</sub> = 85°C (lm)	Typical Efficacy T <sub>c</sub> = 25°C (lm/W)
BXRE-30E6500-B-7x	80	585	49.6	29.0	5197	4808	179
		780	50.5	39.4	6747	6168	171
		<b>1170</b>	<b>52.0</b>	<b>60.8</b>	<b>9713</b>	<b>8742</b>	<b>160</b>
		1755	54.3	95.3	13830	12304	145
		2340	56.2	131.5	17548	15454	133
BXRE-30E6500-C-7x	80	720	49.6	35.7	6673	5667	187
		960	50.5	48.5	8489	7425	175
		<b>1440</b>	<b>52.0</b>	<b>74.9</b>	<b>11955</b>	<b>10759</b>	<b>160</b>
		2160	54.2	117.0	16740	15390	143
		2880	55.9	161.1	21030	19507	131
BXRE-30E6500-D-7x	80	700	33.2	23.3	4039	3722	174
		1050	34.2	35.9	5950	5457	166
		<b>1400</b>	<b>35.0</b>	<b>49.0</b>	<b>7823</b>	<b>7041</b>	<b>160</b>
		2100	36.4	76.5	11311	10160	148
		2800	37.7	105.6	14566	12949	138
BXRE-30G65H0-B-7x	90	585	49.6	29.0	4525	4186	156
		780	50.5	39.4	5874	5371	149
		<b>1170</b>	<b>52.0</b>	<b>60.8</b>	<b>8457</b>	<b>7611</b>	<b>139</b>
		1755	54.3	95.3	12041	10713	126
		2340	56.2	131.5	15278	13455	116
BXRE-30G65H0-C-7x	90	720	49.6	35.7	5810	4934	163
		960	50.5	48.5	7391	6465	153
		<b>1440</b>	<b>52.0</b>	<b>74.9</b>	<b>10408</b>	<b>9367</b>	<b>139</b>
		2160	54.2	117.0	14575	13399	125
		2880	55.9	161.1	18310	16984	114
BXRE-30G65H0-D-7x	90	700	33.2	23.3	3516	3240	151
		1050	34.2	35.9	5180	4751	144
		<b>1400</b>	<b>35.0</b>	<b>49.0</b>	<b>6811</b>	<b>6130</b>	<b>139</b>
		2100	36.4	76.5	9848	8846	129
		2800	37.7	105.6	12682	11274	120
BXRE-30G6500-B-7x	90	585	49.6	29.0	4326	4002	149
		780	50.5	39.4	5615	5134	143
		<b>1170</b>	<b>52.0</b>	<b>60.8</b>	<b>8084</b>	<b>7275</b>	<b>133</b>
		1755	54.3	95.3	11510	10240	121
		2340	56.2	131.5	14604	12862	111
BXRE-30G6500-C-7x	90	720	49.6	35.7	5554	4716	155
		960	50.5	48.5	7065	6180	146
		<b>1440</b>	<b>52.0</b>	<b>74.9</b>	<b>9949</b>	<b>8954</b>	<b>133</b>
		2160	54.2	117.0	13932	12808	119
		2880	55.9	161.1	17502	16235	109
BXRE-30G6500-D-7x	90	700	33.2	23.3	3361	3097	144
		1050	34.2	35.9	4952	4541	138
		<b>1400</b>	<b>35.0</b>	<b>49.0</b>	<b>6511</b>	<b>5860</b>	<b>133</b>
		2100	36.4	76.5	9413	8456	123
		2800	37.7	105.6	12123	10777	115

Notes for Table 4:

1. Alternate drive currents are provided for reference only and are not a guarantee of performance.
2. Bridgelux maintains a ± 7% tolerance on flux measurements.
3. Typical stabilized DC performance values are provided as reference only and are not a guarantee of performance.

# Performance at Commonly Used Drive Currents

**Table 4:** Product Performance at Commonly Used Drive Currents (Continued)

Part Number	CRI	Drive Current <sup>1</sup> (mA)	Typical V <sub>f</sub> T <sub>c</sub> = 25°C (V)	Typical Power T <sub>c</sub> = 25°C (W)	Typical Flux <sup>2</sup> T <sub>c</sub> = 25°C (lm)	Typical DC Flux <sup>3</sup> T <sub>c</sub> = 85°C (lm)	Typical Efficacy T <sub>c</sub> = 25°C (lm/W)
BXRE-30G650C-D-73	90	700	33.2	23.3	3127	2881	134
		1050	34.2	35.9	4607	4225	128
		<b>1400</b>	<b>35.0</b>	<b>49.0</b>	<b>6056</b>	<b>5451</b>	<b>123</b>
		2100	36.4	76.5	8757	7866	114
		2800	37.7	105.6	11277	10025	107
BXRE-30H6500-D-7x	97	700	33.2	23.3	2996	2761	129
		1050	34.2	35.9	4415	4049	123
		<b>1400</b>	<b>35.0</b>	<b>49.0</b>	<b>5804</b>	<b>5224</b>	<b>118</b>
		2100	36.4	76.5	8392	7538	110
		2800	37.7	105.6	10807	9607	102
BXRE-35E6500-B-7x	80	585	49.6	29.0	5365	4963	185
		780	50.5	39.4	6965	6367	177
		<b>1170</b>	<b>52.0</b>	<b>60.8</b>	<b>10026</b>	<b>9024</b>	<b>165</b>
		1755	54.3	95.3	14276	12701	150
		2340	56.2	131.5	18114	15952	138
BXRE-35E6500-C-7x	80	720	49.6	35.7	6888	5850	193
		960	50.5	48.5	8762	7665	181
		<b>1440</b>	<b>52.0</b>	<b>74.9</b>	<b>12340</b>	<b>11106</b>	<b>165</b>
		2160	54.2	117.0	17280	15886	148
		2880	55.9	161.1	21708	20137	135
BXRE-35E6500-D-7x	80	700	33.2	23.3	4169	3842	179
		1050	34.2	35.9	6142	5633	171
		<b>1400</b>	<b>35.0</b>	<b>49.0</b>	<b>8075</b>	<b>7268</b>	<b>165</b>
		2100	36.4	76.5	11675	10488	153
		2800	37.7	105.6	15036	13367	142
BXRE-35G6500-B-7x	90	585	49.6	29.0	4460	4126	154
		780	50.5	39.4	5789	5293	147
		<b>1170</b>	<b>52.0</b>	<b>60.8</b>	<b>8334</b>	<b>7501</b>	<b>137</b>
		1755	54.3	95.3	11867	10558	125
		2340	56.2	131.5	15057	13260	115
BXRE-35G6500-C-7x	90	720	49.6	35.7	5726	4863	160
		960	50.5	48.5	7284	6371	150
		<b>1440</b>	<b>52.0</b>	<b>74.9</b>	<b>10258</b>	<b>9232</b>	<b>137</b>
		2160	54.2	117.0	14364	13205	123
		2880	55.9	161.1	18045	16739	112
BXRE-35G6500-D-7x	90	700	33.2	23.3	3465	3193	149
		1050	34.2	35.9	5106	4682	142
		<b>1400</b>	<b>35.0</b>	<b>49.0</b>	<b>6713</b>	<b>6041</b>	<b>137</b>
		2100	36.4	76.5	9705	8718	127
		2800	37.7	105.6	12499	11111	118
BXRE-35A6501-D-73	93	700	33.2	23.3	3263	3007	140
		1050	34.2	35.9	4808	4409	134
		<b>1400</b>	<b>35.0</b>	<b>49.0</b>	<b>6321</b>	<b>5689</b>	<b>129</b>
		2100	36.4	76.5	9139	8210	119
		2800	37.7	105.6	11770	10463	111

Notes for Table 4:

1. Alternate drive currents are provided for reference only and are not a guarantee of performance.
2. Bridgelux maintains a ± 7% tolerance on flux measurements.
3. Typical stabilized DC performance values are provided as reference only and are not a guarantee of performance.

# Performance at Commonly Used Drive Currents

**Table 4:** Product Performance at Commonly Used Drive Currents (Continued)

Part Number	CRI	Drive Current <sup>1</sup> (mA)	Typical V <sub>f</sub> T <sub>c</sub> = 25°C (V)	Typical Power T <sub>c</sub> = 25°C (W)	Typical Flux <sup>2</sup> T <sub>c</sub> = 25°C (lm)	Typical DC Flux <sup>3</sup> T <sub>c</sub> = 85°C (lm)	Typical Efficacy T <sub>c</sub> = 25°C (lm/W)
BXRE-40C6501-B-74	70	585	49.6	29.0	6121	5198	211
		780	50.5	39.4	7787	6811	198
		<b>1170</b>	<b>52.0</b>	<b>60.8</b>	<b>10966</b>	<b>9870</b>	<b>180</b>
		1755	54.3	95.3	15356	14118	161
		2340	56.2	131.5	19292	17895	147
BXRE-40C6501-C-74	70	720	49.6	35.7	6968	6421	195
		960	50.5	48.5	10266	9415	212
		<b>1440</b>	<b>52.0</b>	<b>74.9</b>	<b>13497</b>	<b>12147</b>	<b>180</b>
		2160	54.2	117.0	19515	17530	167
		2880	55.9	161.1	25131	22342	156
BXRE-40C6501-D-74	70	700	33.2	23.3	4560	4202	196
		1050	34.2	35.9	6718	6161	187
		<b>1400</b>	<b>35.0</b>	<b>49.0</b>	<b>8832</b>	<b>7949</b>	<b>180</b>
		2100	36.4	76.5	12770	11471	167
		2800	37.7	105.6	16445	14620	156
BXRE-40E6500-B-7x	80	585	49.6	29.0	5399	4994	186
		780	50.5	39.4	7008	6407	178
		<b>1170</b>	<b>52.0</b>	<b>60.8</b>	<b>10089</b>	<b>9080</b>	<b>166</b>
		1755	54.3	95.3	14365	12780	151
		2340	56.2	131.5	18227	16052	139
BXRE-40E6500-C-7x	80	720	49.6	35.7	6931	5886	194
		960	50.5	48.5	8817	7712	182
		<b>1440</b>	<b>52.0</b>	<b>74.9</b>	<b>12417</b>	<b>11176</b>	<b>166</b>
		2160	54.2	117.0	17388	15985	149
		2880	55.9	161.1	21844	20263	136
BXRE-40E6500-D-7x	80	700	33.2	23.3	4195	3866	180
		1050	34.2	35.9	6180	5668	172
		<b>1400</b>	<b>35.0</b>	<b>49.0</b>	<b>8126</b>	<b>7313</b>	<b>166</b>
		2100	36.4	76.5	11748	10554	153
		2800	37.7	105.6	15130	13450	143
BXRE-40G6500-B-7x	90	585	49.6	29.0	4627	4281	159
		780	50.5	39.4	6007	5492	153
		<b>1170</b>	<b>52.0</b>	<b>60.8</b>	<b>8648</b>	<b>7783</b>	<b>142</b>
		1755	54.3	95.3	12313	10955	129
		2340	56.2	131.5	15623	13759	119
BXRE-40G6500-C-7x	90	720	49.6	35.7	5941	5045	166
		960	50.5	48.5	7558	6611	156
		<b>1440</b>	<b>52.0</b>	<b>74.9</b>	<b>10643</b>	<b>9579</b>	<b>142</b>
		2160	54.2	117.0	14904	13702	127
		2880	55.9	161.1	18724	17368	116
BXRE-40G6500-D-7x	90	700	33.2	23.3	3596	3313	155
		1050	34.2	35.9	5298	4858	147
		<b>1400</b>	<b>35.0</b>	<b>49.0</b>	<b>6965</b>	<b>6268</b>	<b>142</b>
		2100	36.4	76.5	10070	9046	132
		2800	37.7	105.6	12968	11529	123

Notes for Table 4:

1. Alternate drive currents are provided for reference only and are not a guarantee of performance.
2. Bridgelux maintains a ± 7% tolerance on flux measurements.
3. Typical stabilized DC performance values are provided as reference only and are not a guarantee of performance.

# Performance at Commonly Used Drive Currents

**Table 4:** Product Performance at Commonly Used Drive Currents (Continued)

Part Number	CRI	Drive Current <sup>1</sup> (mA)	Typical V <sub>f</sub> T <sub>c</sub> = 25°C (V)	Typical Power T <sub>c</sub> = 25°C (W)	Typical Flux <sup>2</sup> T <sub>c</sub> = 25°C (lm)	Typical DC Flux <sup>3</sup> T <sub>c</sub> = 85°C (lm)	Typical Efficacy T <sub>c</sub> = 25°C (lm/W)
BXRE-40H6500-D-73	97	700	33.2	23.3	3086	2844	133
		1050	34.2	35.9	4547	4170	126
		<b>1400</b>	<b>35.0</b>	<b>49.0</b>	<b>5978</b>	<b>5380</b>	<b>122</b>
		2100	36.4	76.5	8643	7764	113
BXRE-50C6501-B-7x	70	2800	37.7	105.6	11131	9895	105
		585	49.6	29.0	5935	5491	204
		780	50.5	39.4	7705	7044	196
		<b>1170</b>	<b>52.0</b>	<b>60.8</b>	<b>11092</b>	<b>9983</b>	<b>182</b>
BXRE-50C6501-C-7x	70	1755	54.3	95.3	15793	14051	166
		2340	56.2	131.5	20038	17647	152
		720	49.6	35.7	7620	6471	213
		960	50.5	48.5	9694	8479	200
BXRE-50C6501-D-7x	70	<b>1440</b>	<b>52.0</b>	<b>74.9</b>	<b>13651</b>	<b>12286</b>	<b>182</b>
		2160	54.2	117.0	19116	17574	163
		2880	55.9	161.1	24015	22276	149
		700	33.2	23.3	4612	4250	198
BXRE-50E6501-B-7x	80	1050	34.2	35.9	6795	6231	189
		<b>1170</b>	<b>52.0</b>	<b>60.8</b>	<b>10402</b>	<b>9362</b>	<b>171</b>
		1755	54.3	95.3	14811	13177	155
		2340	56.2	131.5	18793	16551	143
BXRE-50E6501-C-7x	80	720	49.6	35.7	7147	6069	200
		960	50.5	48.5	9091	7952	188
		<b>1440</b>	<b>52.0</b>	<b>74.9</b>	<b>12803</b>	<b>11523</b>	<b>171</b>
		2160	54.2	117.0	17928	16482	153
BXRE-50E6501-D-7x	80	2880	55.9	161.1	22523	20892	140
		700	33.2	23.3	4325	3986	186
		1050	34.2	35.9	6372	5844	177
		<b>1400</b>	<b>35.0</b>	<b>49.0</b>	<b>8378</b>	<b>7540</b>	<b>171</b>
BXRE-50G6501-B-7x	90	2100	36.4	76.5	12113	10882	158
		2800	37.7	105.6	15600	13868	148
		585	49.6	29.0	4728	4374	163
		780	50.5	39.4	6138	5611	156
BXRE-50G6501-C-7x	90	<b>1170</b>	<b>52.0</b>	<b>60.8</b>	<b>8836</b>	<b>7952</b>	<b>145</b>
		1755	54.3	95.3	12581	11193	132
		2340	56.2	131.5	15963	14058	121
		720	49.6	35.7	6070	5155	170
BXRE-50G6501-D-7x	90	960	50.5	48.5	7722	6754	159
		<b>1440</b>	<b>52.0</b>	<b>74.9</b>	<b>10875</b>	<b>9787</b>	<b>145</b>
		2160	54.2	117.0	15228	14000	130
		2880	55.9	161.1	19131	17745	119

Notes for Table 4:

1. Alternate drive currents are provided for reference only and are not a guarantee of performance.
2. Bridgelux maintains a ± 7% tolerance on flux measurements.
3. Typical stabilized DC performance values are provided as reference only and are not a guarantee of performance.

# Performance at Commonly Used Drive Currents

**Table 4:** Product Performance at Commonly Used Drive Currents (Continued)

Part Number	CRI	Drive Current <sup>1</sup> (mA)	Typical V <sub>f</sub> T <sub>c</sub> = 25°C (V)	Typical Power T <sub>c</sub> = 25°C (W)	Typical Flux <sup>2</sup> T <sub>c</sub> = 25°C (lm)	Typical DC Flux <sup>3</sup> T <sub>c</sub> = 85°C (lm)	Typical Efficacy T <sub>c</sub> = 25°C (lm/W)
BXRE-50G6501-D-7x	90	700	33.2	23.3	3674	3385	158
		1050	34.2	35.9	5413	4964	151
		<b>1400</b>	<b>35.0</b>	<b>49.0</b>	<b>7116</b>	<b>6405</b>	<b>145</b>
		2100	36.4	76.5	10289	9243	134
		2800	37.7	105.6	13250	11779	125
BXRE-56G6501-D-7x	90	700	33.2	23.3	3856	3554	166
		1050	34.2	35.9	5681	5210	158
		<b>1400</b>	<b>35.0</b>	<b>49.0</b>	<b>7470</b>	<b>6723</b>	<b>152</b>
		2100	36.4	76.5	10800	9702	141
		2800	37.7	105.6	13908	12364	132
BXRE-57C6501-B-7x	70	585	49.6	29.0	5734	5305	197
		780	50.5	39.4	7443	6805	189
		<b>1170</b>	<b>52.0</b>	<b>60.8</b>	<b>10716</b>	<b>9644</b>	<b>176</b>
		1755	54.3	95.3	15257	13574	160
		2340	56.2	131.5	19359	17049	147
BXRE-57C6501-C-7x	70	720	49.6	35.7	7362	6252	206
		960	50.5	48.5	9365	8192	193
		<b>1440</b>	<b>52.0</b>	<b>74.9</b>	<b>13189</b>	<b>11870</b>	<b>176</b>
		2160	54.2	117.0	18468	16978	158
		2880	55.9	161.1	23201	21521	144
BXRE-57C6501-D-74	70	700	33.2	23.3	4455	4106	191
		1050	34.2	35.9	6564	6020	183
		<b>1400</b>	<b>35.0</b>	<b>49.0</b>	<b>8630</b>	<b>7767</b>	<b>176</b>
		2100	36.4	76.5	12478	11209	163
		2800	37.7	105.6	16070	14286	152
BXRE-57E6501-B-7x	80	585	49.6	29.0	5502	5090	189
		780	50.5	39.4	7142	6530	181
		<b>1170</b>	<b>52.0</b>	<b>60.8</b>	<b>10282</b>	<b>9254</b>	<b>169</b>
		1755	54.3	95.3	14640	13025	154
		2340	56.2	131.5	18575	16359	141
BXRE-57E6501-C-7x	80	720	49.6	35.7	7064	5999	198
		960	50.5	48.5	8986	7860	185
		<b>1440</b>	<b>52.0</b>	<b>74.9</b>	<b>12655</b>	<b>11389</b>	<b>169</b>
		2160	54.2	117.0	17721	16291	151
		2880	55.9	161.1	22262	20650	138
BXRE-57E6501-D-74	80	700	33.2	23.3	4275	3940	184
		1050	34.2	35.9	6299	5776	175
		<b>1400</b>	<b>35.0</b>	<b>49.0</b>	<b>8281</b>	<b>7453</b>	<b>169</b>
		2100	36.4	76.5	11973	10756	156
		2800	37.7	105.6	15419	13707	146
BXRE-65C6501-B-7x	70	585	49.6	29.0	5835	5398	201
		780	50.5	39.4	7574	6924	192
		<b>1170</b>	<b>52.0</b>	<b>60.8</b>	<b>10904</b>	<b>9813</b>	<b>179</b>
		1755	54.3	95.3	15525	13812	163
		2340	56.2	131.5	19699	17348	150

Notes for Table 4:

1. Alternate drive currents are provided for reference only and are not a guarantee of performance.
2. Bridgelux maintains a ± 7% tolerance on flux measurements.
3. Typical stabilized DC performance values are provided as reference only and are not a guarantee of performance.

# Performance at Commonly Used Drive Currents

**Table 4:** Product Performance at Commonly Used Drive Currents (Continued)

Part Number	CRI	Drive Current <sup>1</sup> (mA)	Typical $V_f$ $T_c = 25^\circ\text{C}$ (V)	Typical Power $T_c = 25^\circ\text{C}$ (W)	Typical Flux <sup>2</sup> $T_c = 25^\circ\text{C}$ (lm)	Typical DC Flux <sup>3</sup> $T_c = 85^\circ\text{C}$ (lm)	Typical Efficacy $T_c = 25^\circ\text{C}$ (lm/W)
BXRE-65C6501-C-7x	70	720	49.6	35.7	7491	6362	210
		960	50.5	48.5	9529	8335	197
		<b>1440</b>	<b>52.0</b>	<b>74.9</b>	<b>13420</b>	<b>12078</b>	<b>179</b>
		2160	54.2	117.0	18792	17276	161
		2880	55.9	161.1	23608	21899	147
BXRE-65C6501-D-7x	70	700	33.2	23.3	4534	4178	195
		1050	34.2	35.9	6679	6126	186
		<b>1400</b>	<b>35.0</b>	<b>49.0</b>	<b>8782</b>	<b>7904</b>	<b>179</b>
		2100	36.4	76.5	12697	11406	166
		2800	37.7	105.6	16351	14536	155
BXRE-65E6501-B-7x	80	585	49.6	29.0	5600	5180	193
		780	50.5	39.4	7269	6646	185
		<b>1170</b>	<b>52.0</b>	<b>60.8</b>	<b>10464</b>	<b>9418</b>	<b>172</b>
		1755	54.3	95.3	14900	13256	156
		2340	56.2	131.5	18905	16649	144
BXRE-65E6501-C-7x	80	720	49.6	35.7	7189	6105	201
		960	50.5	48.5	9145	7999	189
		<b>1440</b>	<b>52.0</b>	<b>74.9</b>	<b>12879</b>	<b>11591</b>	<b>172</b>
		2160	54.2	117.0	18035	16580	154
		2880	55.9	161.1	22657	21016	141
BXRE-65E6501-D-7x	80	700	33.2	23.3	4351	4010	187
		1050	34.2	35.9	6410	5879	178
		<b>1400</b>	<b>35.0</b>	<b>49.0</b>	<b>8428</b>	<b>7585</b>	<b>172</b>
		2100	36.4	76.5	12185	10946	159
		2800	37.7	105.6	15693	13951	149

Notes for Table 4:

1. Alternate drive currents are provided for reference only and are not a guarantee of performance.
2. Bridgelux maintains a  $\pm 7\%$  tolerance on flux measurements.
3. Typical stabilized DC performance values are provided as reference only and are not a guarantee of performance.

# Electrical Characteristics

**Table 5:** Electrical Characteristics

Part Number	Drive Current (mA)	Forward Voltage Pulsed, $T_c = 25^\circ\text{C}$ (V) <sup>1, 2, 3, 8</sup>			Typical Coefficient of Forward Voltage <sup>4</sup> $\Delta V_f / \Delta T_c$ (mV/ $^\circ\text{C}$ )	Typical Thermal Resistance Junction to Case <sup>5,6</sup> $R_{j-c}$ ( $^\circ\text{C}/\text{W}$ )	Driver Selection Voltages <sup>7</sup> (V)	
		Minimum	Typical	Maximum			$V_f$ Min. Hot $T_c = 105^\circ\text{C}$ (V)	$V_f$ Max. Cold $T_c = -40^\circ\text{C}$ (V)
BXRE-xxx650x-B-7x	1170	48.1	52.0	55.9	-22.1	0.07	46.3	57.3
	2340	52.0	56.2	60.4	-22.1	0.09	50.2	61.8
BXRE-xxx650x-C-7x	1440	48.1	52.0	55.9	-22.1	0.06	46.3	57.3
	2880	51.7	55.9	60.1	-22.1	0.08	50.0	61.6
BXRE-xxx650x-D-7x	1400	32.4	35.0	37.6	-22.1	0.07	30.6	39.1
	2800	35.0	37.7	40.4	-22.1	0.08	33.2	41.8

Notes for Table 5:

- Parts are tested in pulsed conditions.  $T_c = 25^\circ\text{C}$ . Pulse width is 10ms.
- Voltage minimum and maximum are provided for reference only and are not a guarantee of performance.
- Bridgelux maintains a tester tolerance of  $\pm 0.10\text{V}$  on forward voltage measurements.
- Typical coefficient of forward voltage tolerance is  $\pm 0.1\text{mV}$  for nominal current.
- Thermal resistance values are based from test data of a 3000K 80 CRI product.
- Thermal resistance value was calculated using total electrical input power; optical power was not subtracted from input power. The thermal interface material used during testing is not included in the thermal resistance value.
- $V_f$  min hot and max cold values are provided as reference only and are not guaranteed by test. These values are provided to aid in driver design and selection over the operating range of the product.
- This product has been designed and manufactured per IEC 62031:2014. This product has passed dielectric withstand voltage testing at 1160 V. The working voltage designated for the insulation is 80V d.c. The maximum allowable voltage across the array must be determined in the end product application.

# Eye Safety

**Table 6:** Eye Safety Risk Group (RG) Classifications

Part Number	Drive Current <sup>5</sup> (mA)	CCT <sup>5</sup>			
		2700K/3000K	4000K <sup>2</sup>	5000K <sup>3</sup>	6500K <sup>4</sup>
BXRE-xxx650x-B-7x	1170	RG1	RG1	RG1	RG1
	1755	RG1	RG1	RG2	RG2
	2340	RG1	RG2	RG2	RG2
BXRE-xxx650x-C-7x	1440	RG1	RG1	RG1	RG2
	2160	RG1	RG1	RG2	RG2
	2880	RG1	RG2	RG2	RG2
BXRE-xxx650x-D-7x	1400	RG1	RG1	RG1	RG1
	2100	RG1	RG1	RG1	RG2
	2800	RG1	RG1	RG2	RG2

Notes for Table 6:

1. Eye safety classification for the use of Bridgelux V Series LED arrays is in accordance with specification IEC/TR 62778: Application of IEC 62471 for the assessment of blue light hazard to light sources and luminaires.
2. For products classified as RG2 at 4000K,  $E_{thr} = 1847.5$  lx.
3. For products classified as RG2 at 5000K,  $E_{thr} = 1315.8$  lx.
4. For products classified as RG2 at 6500K,  $E_{thr} = 1124.5$  lx.
5. Please contact your Bridgelux sales representative for  $E_{thr}$  values at specific drive currents and CCTs not listed.

# Absolute Maximum Ratings

**Table 7:** Maximum Ratings

Parameter	Maximum Rating		
LED Junction Temperature ( $T_j$ )	150°C		
Storage Temperature	-40°C to +105°C		
Operating Case Temperature <sup>1</sup> ( $T_c$ )	105°C		
Soldering Temperature <sup>2</sup>	300°C or lower for a maximum of 6 seconds		
	BXRE-xxx650x-B-7x	BXRE-xxx650x-C-7x	BXRE-xxx650x-D-7x
Maximum Drive Current <sup>3</sup>	2340mA	2880mA	2800mA
Maximum Peak Pulsed Drive Current <sup>4</sup>	3340mA	4110mA	4000mA
Maximum Reverse Voltage <sup>5</sup>	-90V	-90V	-60V

Notes for Table 7:

1. For IEC 62717 requirement, please consult your Bridgelux sales representative.
2. Refer to Bridgelux Application Note AN101: Handling and Assembly of Bridgelux V Series LED Arrays
3. Arrays may be driven at higher currents however lumen maintenance may be reduced.
4. Bridgelux recommends a maximum duty cycle of 10% and pulse width of 20 ms when operating LED Arrays at maximum peak pulsed current specified. Maximum peak pulsed currents indicate values where LED Arrays can be driven without catastrophic failures.
5. Light emitting diodes are not designed to be driven in reverse voltage and will not produce light under this condition. Maximum rating provided for reference only.

# Performance Curves

**Figure 1: V22B Drive Current vs. Voltage**

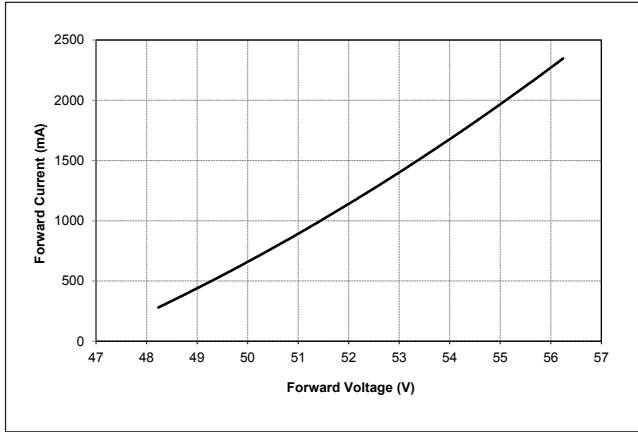

**Figure 2: V22C Drive Current vs. Voltage**

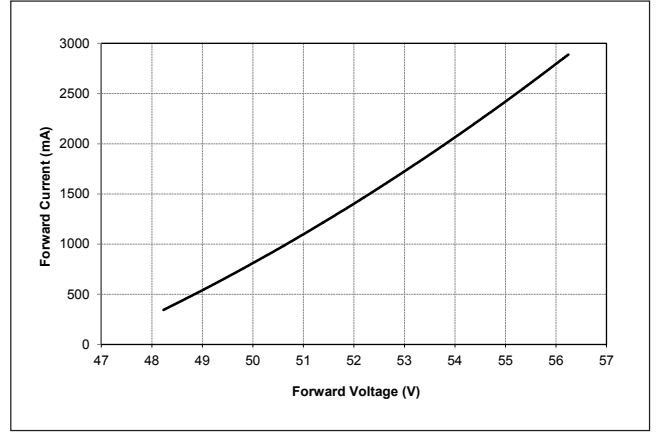

**Figure 3: V22D Drive Current vs. Voltage**

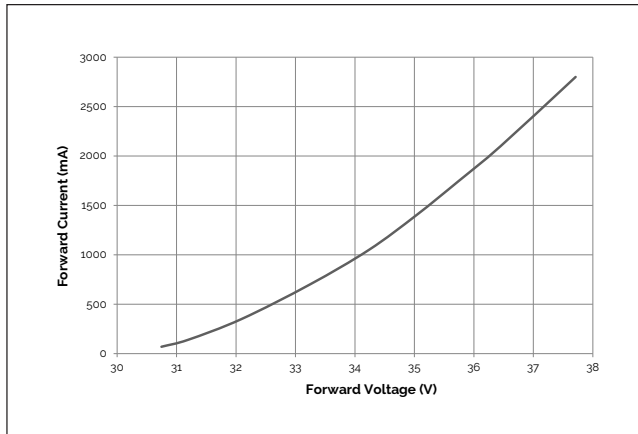

**Figure 4: V22B Typical Relative Flux vs. Current**

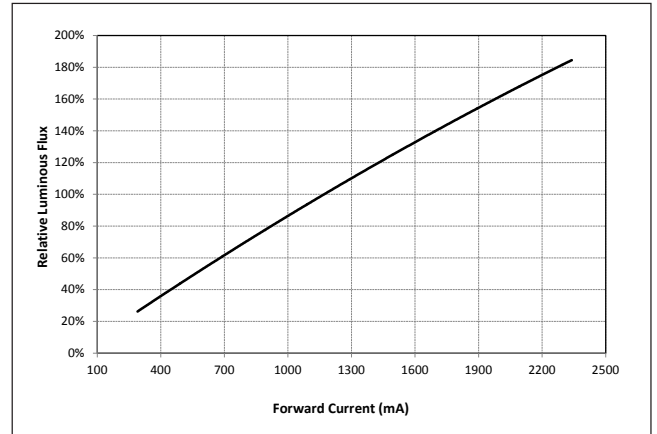

**Figure 5: V22C Typical Relative Flux vs. Current**

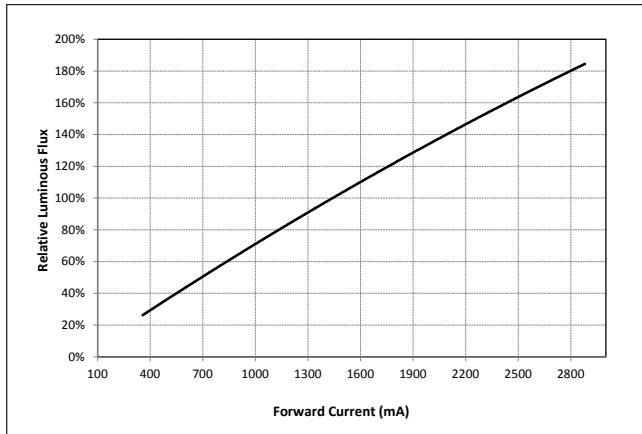

**Figure 6: V22D Typical Relative Flux vs. Current**

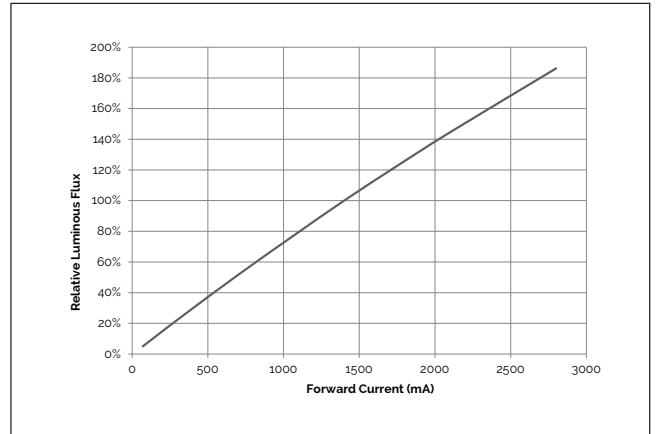

Notes for Figures 1-6:

1. Bridgelux does not recommend driving high power LEDs at low currents. Doing so may produce unpredictable results. Pulse width modulation (PWM) is recommended for dimming effects.
2. Products tested under pulsed condition (10ms pulse width) at nominal test current where  $T_j$  (junction temperature) -  $T_c$  (case temperature) = 25°C.

# Performance Curves

**Figure 7: Typical DC Flux vs. Case Temperature**

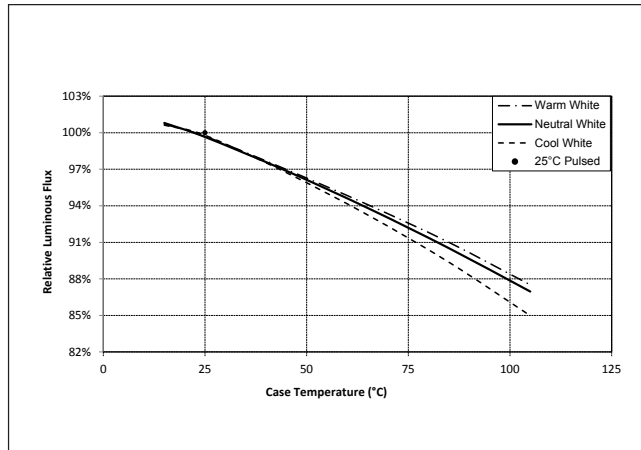

**Figure 8: Typical DC ccy Shift vs. Case Temperature**

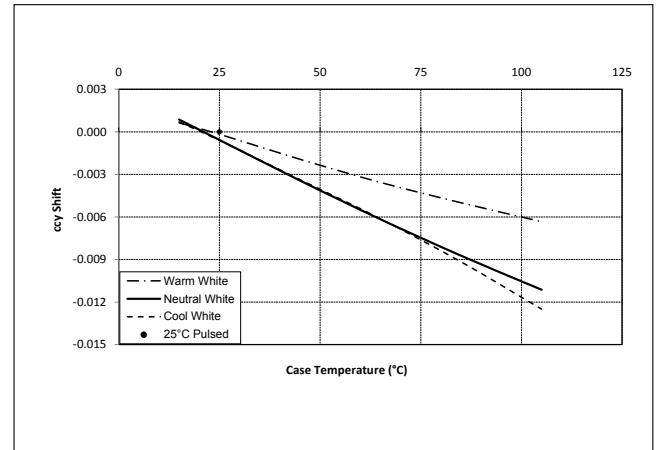

**Figure 9: Typical DC ccx Shift vs. Case Temperature**

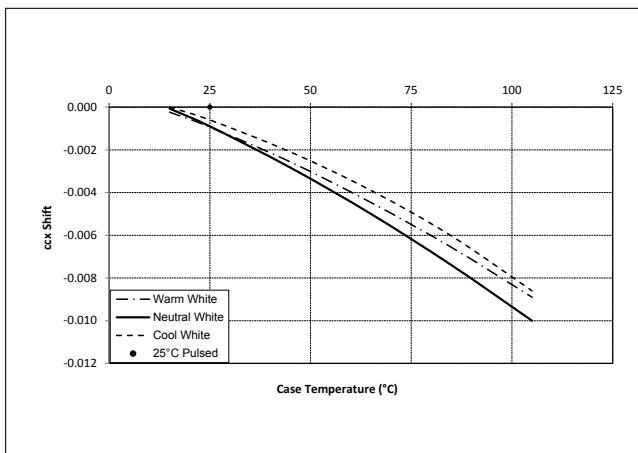

Notes for Figures 7-9:

1. Characteristics shown for warm white based on 3000K and 80 CRI.
2. Characteristics shown for neutral white based on 4000K and 80 CRI.
3. Characteristics shown for cool white based on 5000K and 70 CRI.
4. For other color SKUs, the shift in color will vary. Please contact your Bridgelux Sales Representative for more information.

# Performance Curves

**Figure 10: 1750K Color Shift vs. Case Temperature<sup>1</sup>**

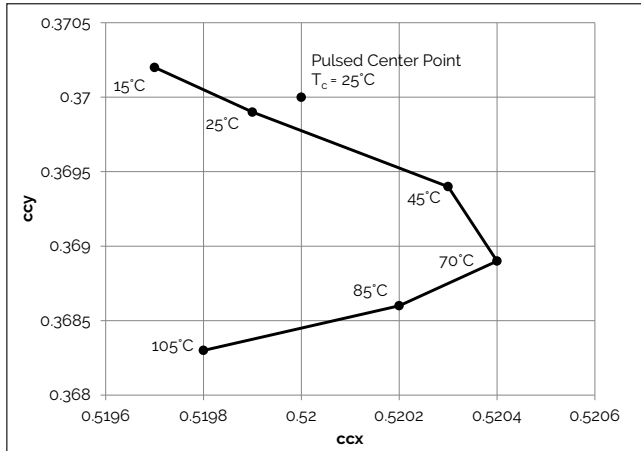

**Figure 11: 2500K Color Shift vs. Case Temperature<sup>1</sup>**

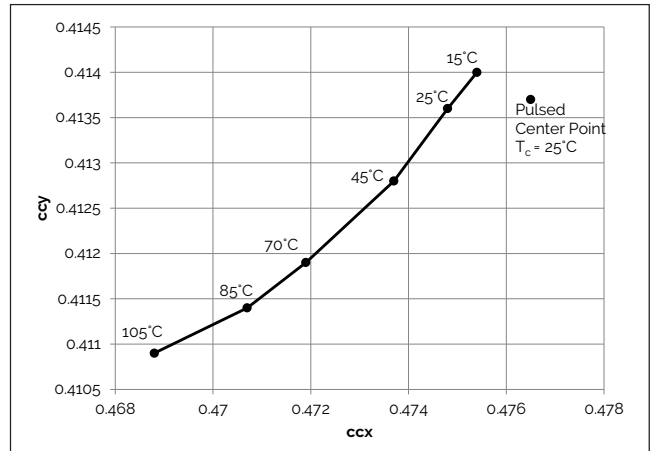

**Figure 12: 2000K, 65 CRI Color Shift vs. Case Temperature**

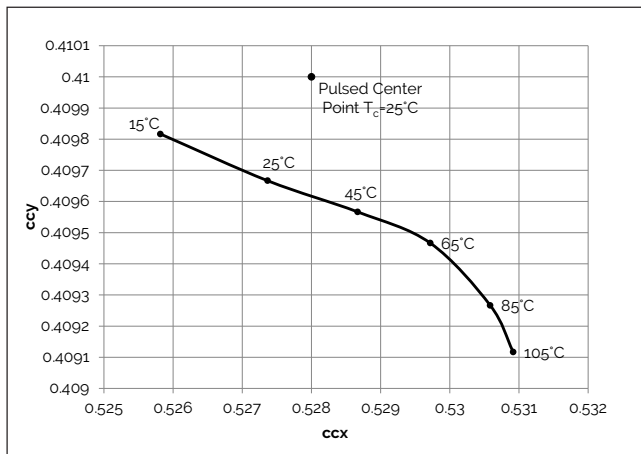

**Figure 13: 3000K, 90 CRI Color Shift vs. Case Temperature<sup>3</sup>**

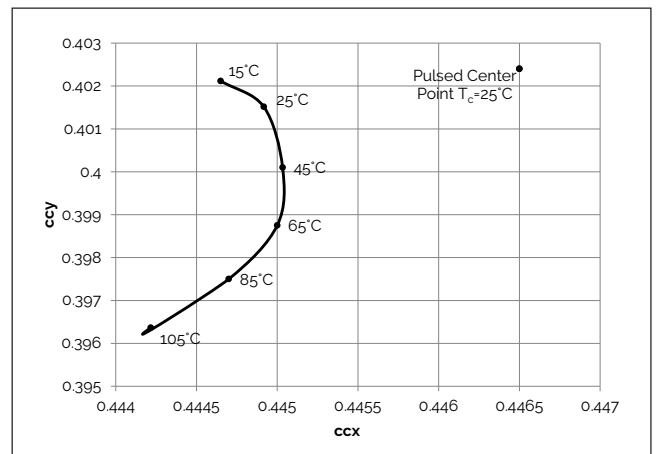

Note for Figures 10-13:

1. Measurements made under DC test conditions at the nominal drive current.
2. Typical color shift is shown with a tolerance of  $\pm 0.002$ .
3. Characteristics shown for Decor Series Showcase products, BXRE-30G650C-x-73

# Performance Curves

**Figure 14: 2700K, 97 CRI Color Shift vs. Case Temperature<sup>1</sup>**

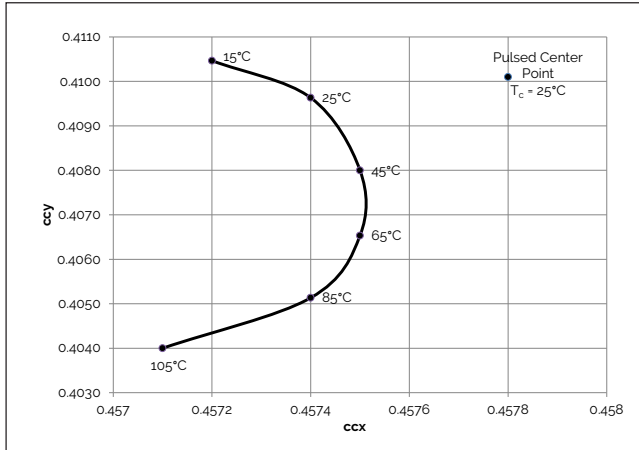

**Figure 15: 3000K, 97 CRI Color Shift vs. Case Temperature<sup>1</sup>**

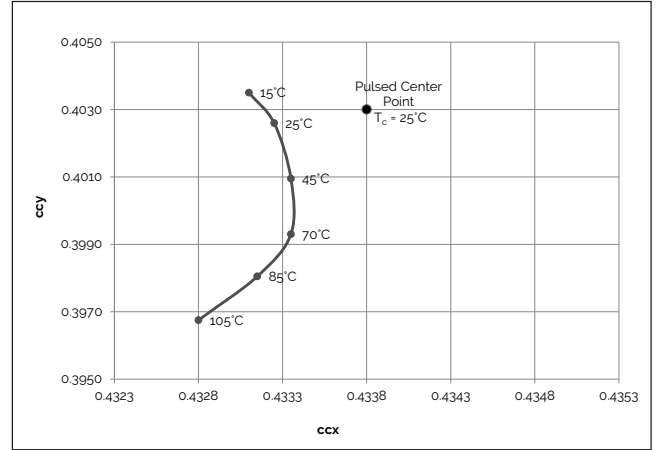

**Figure 16: 5600K Color Shift vs. Case Temperature<sup>1,3</sup>**

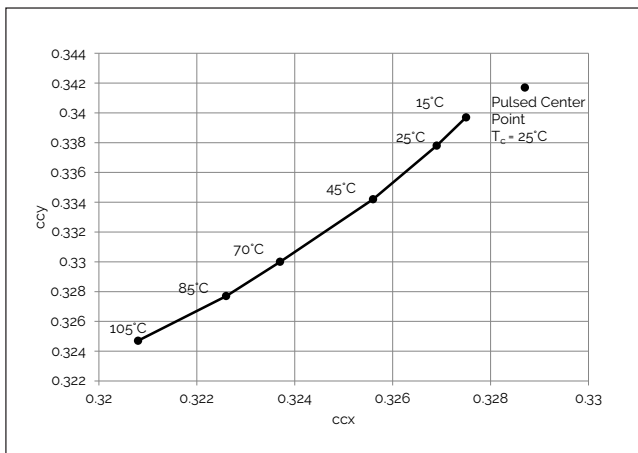

**Figure 17: 3500K Class A Color Shift vs. Case Temperature<sup>1</sup>**

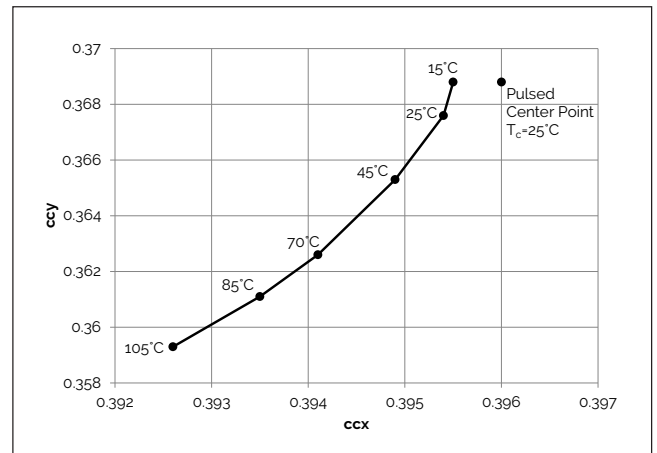

Note for Figures 14-17:

1. Measurements made under DC test conditions at the nominal drive current.
2. Typical color shift is shown with a tolerance of  $\pm 0.002$ .
3. Color shift shown for product hot targeted at  $T_c = 85^\circ\text{C}$

# Typical Radiation Pattern

Figure 18: Typical Spatial Radiation Pattern

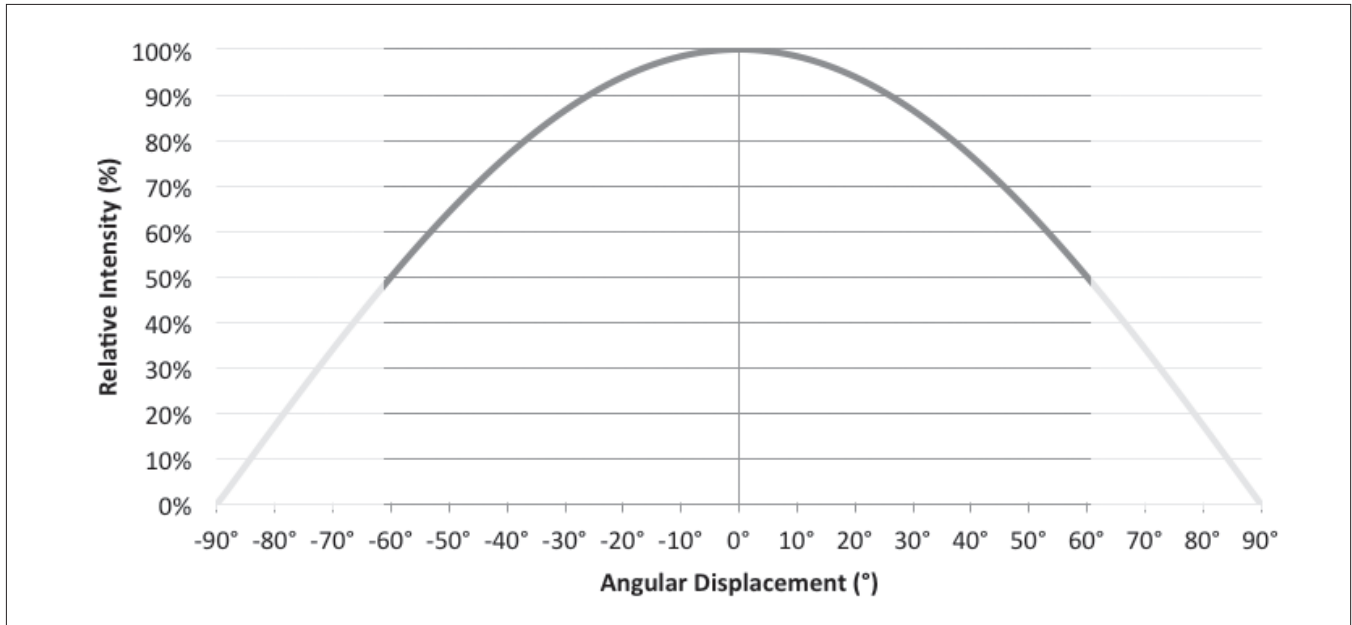

Note for Figure 18:

1. Typical viewing angle is 120°.
2. The viewing angle is defined as the off axis angle from the centerline where intensity is ½ of the peak value.

Figure 19: Typical Polar Radiation Pattern

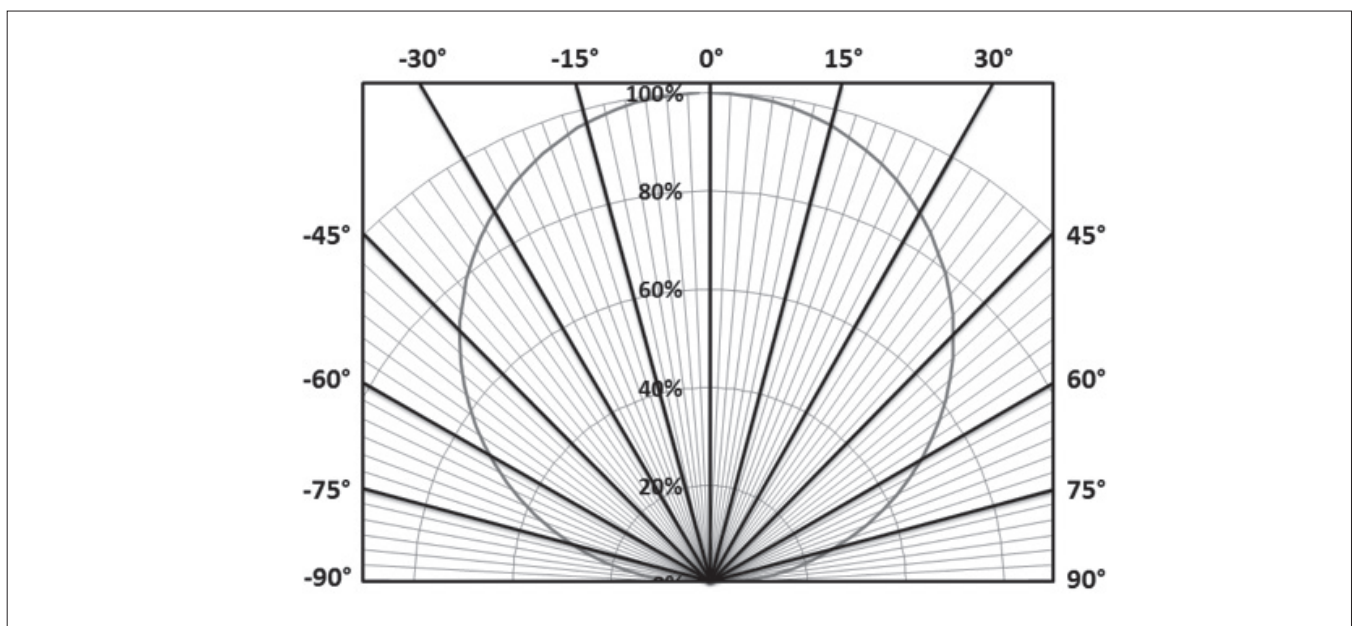

# Typical Color Spectrum

Figure 20: Typical Color Spectrum

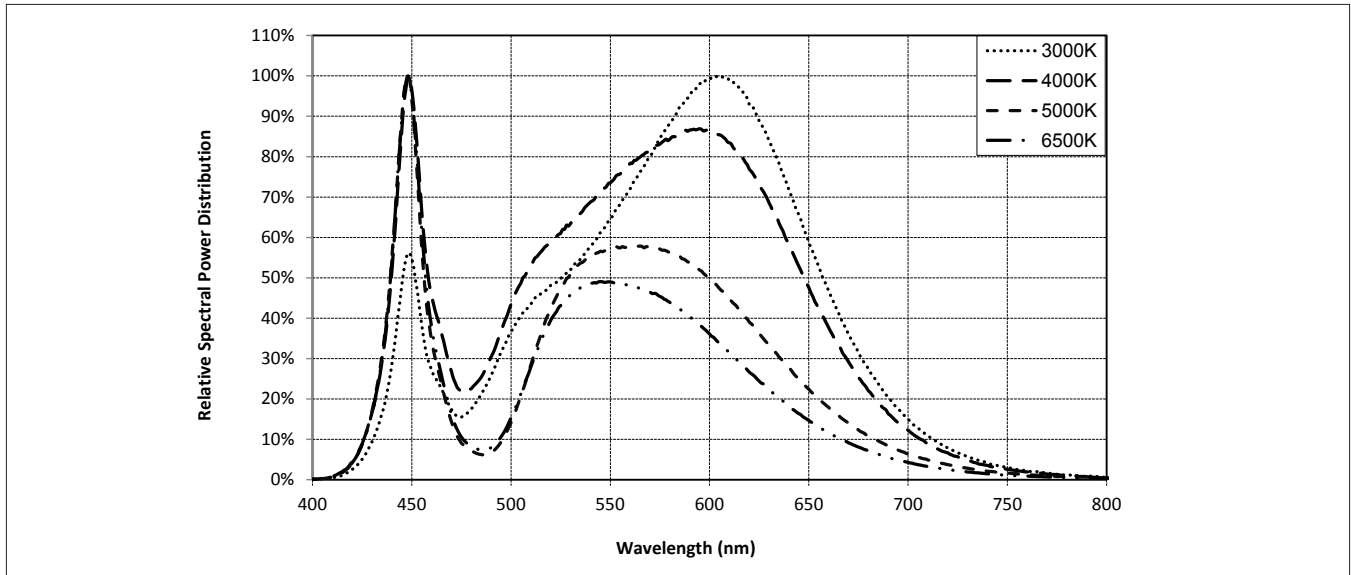

Note for Figure 20:

1. Color spectra measured at nominal current for  $T_j = T_c = 25^\circ\text{C}$ .
2. Color spectra shown is 3000K and 80 CRI.
3. Color spectra shown is 4000K and 80 CRI.
4. Color spectra shown is 5000K and 70 CRI.
4. Color spectra shown is 6500K and 70 CRI.

Figure 21: Typical Color Spectrum for Décor Series

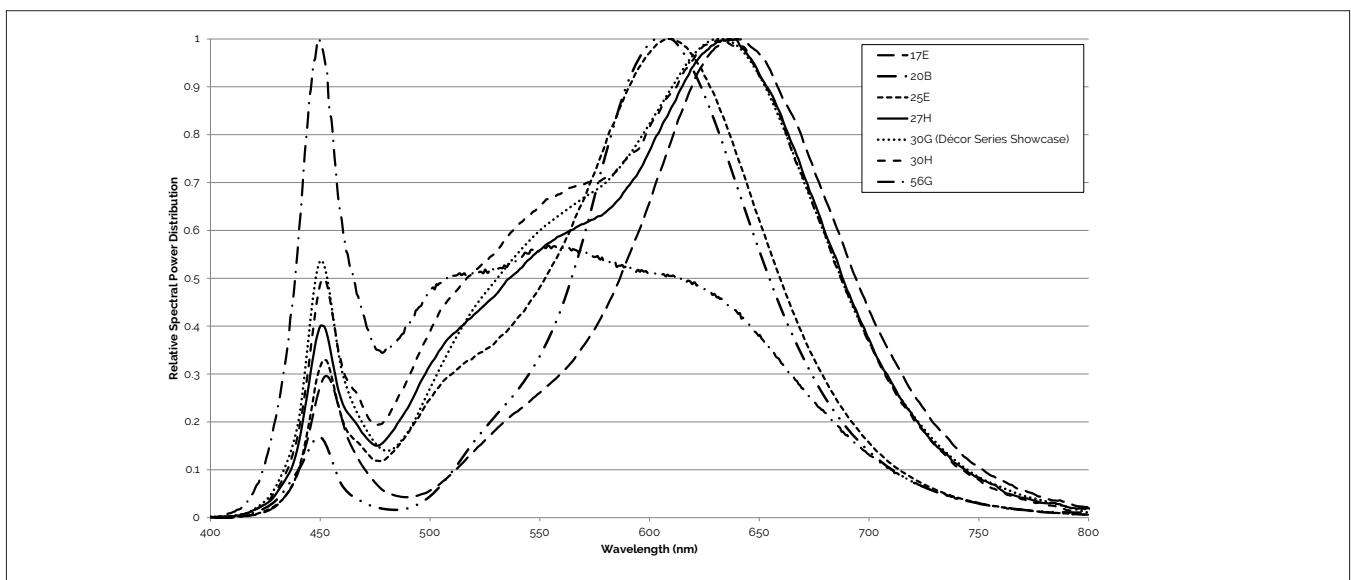

Note for Figure 21:

1. Color spectra measured at nominal current for  $T_j = T_c = 25^\circ\text{C}$ .



# Color Binning Information

**Figure 23: Graph of Warm and Neutral White Test Bins in xy Color Space**

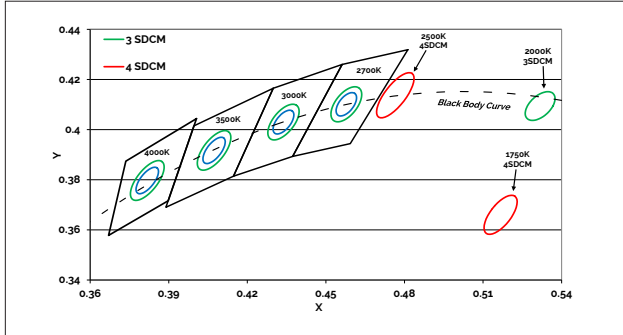

Note: Pulsed Test Conditions,  $T_c = 25^\circ\text{C}$

**Table 8: Warm and Neutral White xy Bin Coordinates and Associated Typical CCT**

Bin Code	2000K	2700K	3000K <sup>1</sup>	3500K <sup>1</sup>	4000K <sup>1</sup>
ANSI Bin (for reference only)	-	(2580K - 2870K)	(2870K - 3220K)	(3220K - 3710K)	(3710K - 4260K)
73 (3 SDCM)	-	(2651K - 2794K)	(2968K - 3136K)	(3369K - 3586K)	(3851K - 4130K)
72 (2 SDCM)	-	(2674K - 2769K)	(2995K - 3107K)	(3404K - 3548K)	(3895K - 4081K)
Center Point (x,y)	(0.5280, 0.4100)	(0.4578, 0.4101)	(0.4338, 0.403) (0.4465, 0.4024) <sup>2</sup>	(0.4073, 0.3917)	(0.3818, 0.3797)

Note for Table 8:

1. Color binning information excludes Decor Series Class A products. Please contact your Bridgelux Sales Representative for more information.
2. Center Point for Decor Series Showcase.

**Figure 24: Graph of Cool White Test Bins in xy Color Space**

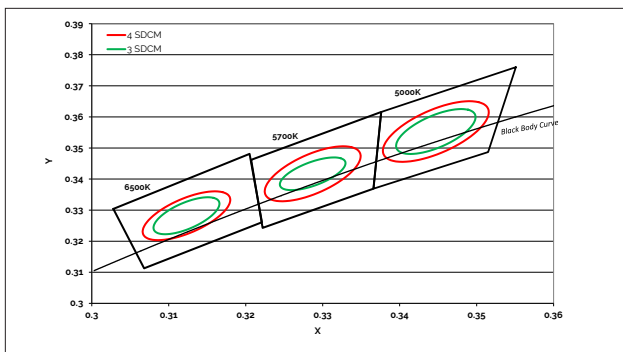

Note: Pulsed Test Conditions,  $T_c = 25^\circ\text{C}$

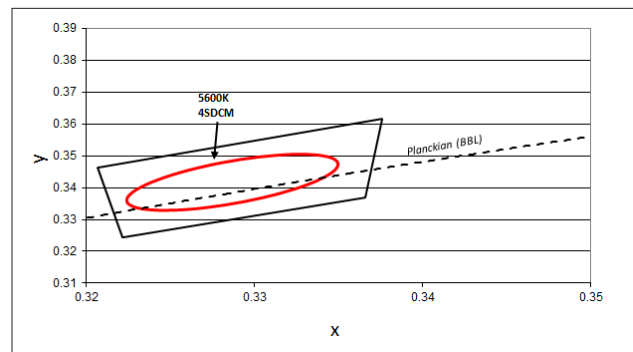

Note: Pulsed Test Conditions,  $T_c = 25^\circ\text{C}$

**Table 9: Cool White xy Bin Coordinates and Associated Typical CCT (product is hot targeted to  $T_c = 85^\circ\text{C}$ )**

Bin Code	5000K	5600K	5700K	6500K
ANSI Bin (for reference only)	(4745K - 5311K)	(5310K - 6020K)	(5312K - 6022K)	(6022K - 7042K)
74 (4 SDCM)	(4801K - 5282K)	(5475K - 5830K)	(5481K - 5829K)	(6270K - 6765K)
73 (3 SDCM)	(4835K - 5215K)	(5490K - 5820K)	(5490K - 5820K)	(6250K - 6745K)
Center Point (x,y)	(0.3447, 0.3553)	(0.3293, 0.3423)	(0.3287, 0.3417)	(0.3123, 0.3282)

Note for Table 9:

1. Select configurations with a CCT of 5600K are available with center point targets at  $T_c = 85^\circ\text{C}$  or  $T_c = 25^\circ\text{C}$ .

# Packaging and Labeling

Figure 25: Drawing for V22 Packaging Tube

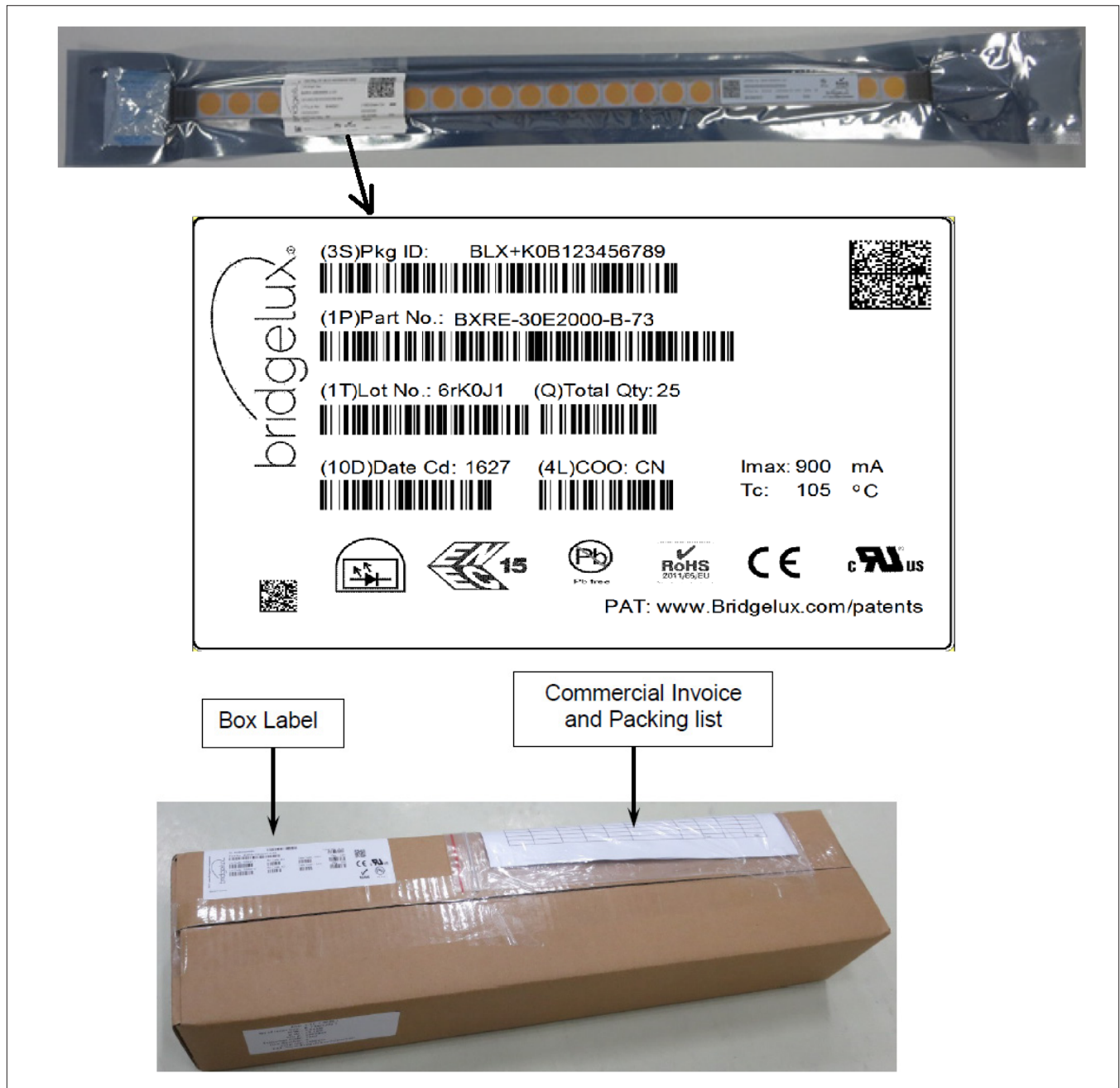

Notes for Figure 25:

1. Each tube holds 15 V22 COB arrays.
2. One tube is sealed in an anti-static bag. Four bags are placed in a shipping box and shipped. Depending on quantities ordered, a bigger shipping box containing four boxes may be used to ship products.
3. Each bag and box is to be labeled as shown above.
4. Dimensions for each tube are 30.7 (W) x 9.65(H) x 460(L). Dimensions for the anti-static bag are 75 (W) x 615 (L) x 3.1 (T) mm. Dimensions for the shipping box are 58.7 x 13.3 x 7.9 cm.

# Packaging and Labeling

**Figure 26: Gen. 7 Product Labeling**

Bridgelux COB arrays have laser markings on the back side of the substrate to help with product identification. In addition to the product identification markings, Bridgelux COB arrays also contain markings for internal Bridgelux manufacturing use only. The image below shows which markings are for customer use and which ones are for Bridgelux internal use only. The Bridgelux internal manufacturing markings are subject to change without notice, however these will not impact the form, function or performance of the COB array.



# Design Resources

## Application Notes

Bridgelux has developed a comprehensive set of application notes and design resources to assist customers in successfully designing with the V Series product family of LED array products. For all available application notes visit [www.bridgelux.com](http://www.bridgelux.com).

## Optical Source Models

Optical source models and ray set files are available for all Bridgelux products. For a list of available formats, visit [www.bridgelux.com](http://www.bridgelux.com).

## 3D CAD Models

Three dimensional CAD models depicting the product outline of all Bridgelux V Series LED arrays are available in both IGS and STEP formats. Please contact your Bridgelux sales representative for assistance.

## LM80

LM80 testing has been completed and the LM80 report is now available. Please contact your Bridgelux sales representative for LM-80 report.

# Precautions

## CAUTION: CHEMICAL EXPOSURE HAZARD

Exposure to some chemicals commonly used in luminaire manufacturing and assembly can cause damage to the LED array. Please consult Bridgelux Application Note AN101 for additional information.

## CAUTION: RISK OF BURN

Do not touch the V Series LED array during operation. Allow the array to cool for a sufficient period of time before handling. The V Series LED array may reach elevated temperatures such that could burn skin when touched.

## CAUTION

### CONTACT WITH LIGHT EMITTING SURFACE (LES)

Avoid any contact with the LES. Do not touch the LES of the LED array or apply stress to the LES (yellow phosphor resin area). Contact may cause damage to the LED array.

Optics and reflectors must not be mounted in contact with the LES (yellow phosphor resin area).

# Disclaimers

## MINOR PRODUCT CHANGE POLICY

The rigorous qualification testing on products offered by Bridgelux provides performance assurance. Slight cosmetic changes that do not affect form, fit, or function may occur as Bridgelux continues product optimization.

## STANDARD TEST CONDITIONS

Unless otherwise stated, array testing is performed at the nominal drive current.

# About Bridgelux: Bridging Light and Life™

At Bridgelux, we help companies, industries and people experience the power and possibility of light. Since 2002, we've designed LED solutions that are high performing, energy efficient, cost effective and easy to integrate. Our focus is on light's impact on human behavior, delivering products that create better environments, experiences and returns—both experiential and financial. And our patented technology drives new platforms for commercial and industrial luminaires.

**For more information about the company, please visit**  
**bridgelux.com**  
**twitter.com/Bridgelux**  
**facebook.com/Bridgelux**  
**youtube.com/user/Bridgelux**  
**linkedin.com/company/bridgelux-inc-\_2**  
**WeChat ID: BridgeluxInChina**



46430 Fremont Boulevard  
Fremont, CA 94538 U.S.A.  
Tel (925) 583-8400  
**www.bridgelux.com**

© 2018 Bridgelux, Inc. All rights reserved 2018. Product specifications are subject to change without notice. Bridgelux, the Bridgelux stylized logo design and Vero are registered trademarks, and Decor Series is a trademark of Bridgelux, Inc. All other trademarks are the property of their respective owners.

**Bridgelux Gen 7 V22 Array Series Product Data Sheet DS103 Rev. N (11/2018)**

## Looking for pricing, stock, or lifecycle information?

Click below to explore more details on WIN SOURCE:

 [View BXRE-50G6501-B-74 on WIN SOURCE](#)

 [Bridgelux Information](#)

## Optimize Your Supply Chain with WIN SOURCE Solutions

-  Global Sourcing Solution
-  Obsolete Management
-  Cost Control Management
-  Shortage Management
-  Alternative Solution
-  Excess Inventory Management