



**THE DATASHEET OF  
ASD1-30.000MHZ-LR-T**



# HCMOS SMD Crystal Oscillator



ASD

2.5 X 2.0 X 1.0 mm

ASD SERIES



ESD Sensitive



RoHS/RoHS II compliant

Moisture Sensitivity Level (MSL) – This product is Hermetically Sealed and not Moisture Sensitive - MSL = N/A: Not Applicable

For Vdd=3.3V & 2.5V and custom frequencies between 8.00MHz & 200.000MHz, or carrier frequency > 60.0MHz, please consider Abracon's [ASG2-C series](#) of XO and VCXO's

## FEATURES:

- Low height 1.0mm max
- Low current consumption
- Tri-state function
- Suitable for RoHS compliant reflow
- Tight stability option
- Seam sealed package assures high reliability

## APPLICATIONS:

- CCD clock for VTR Camera
- Equipment connected to PC or PC cards
- Thin equipment

## STANDARD SPECIFICATIONS:

Parameters	Minimum	Typical	Maximum	Units	Notes	
Frequency Range	0.750		60	MHz		
Operating Temperature	-20		+70	°C	STD temp. Option code E (See options)	
Storage Temperature	-55		+100	°C		
Overall Frequency Stability	-100		+100	ppm	See options	
Supply Voltage (Vdd)	+3.135	+3.3	+3.465	V	ASD (Standard)	
	+2.85	+3.0	+3.15		ASD1	
	+2.375	+2.5	+2.625		ASD2	
	+1.71	+1.8	+1.89		ASD3	
	+0.95	+1.0	+1.05		ASD6	
Input Current (Idd)	ASD (3.3V)		2.5	mA	0.750~15.999 MHz	
			4		7	16.000~39.999 MHz
			9		13	40.000~60.000 MHz
	ASD1 (3.0V)		2.5	4	mA	0.750~15.999 MHz
			3.5	6		16.000~39.999 MHz
			8	12		40.000~60.000 MHz
	ASD2 (2.5V)		2	3.5	mA	0.750~15.999 MHz
			3	5		16.000~39.999 MHz
			7	10		40.000~60.000 MHz
	ASD3 (1.8V)		1	2.5	mA	0.750~15.999 MHz
			2	4		16.000~39.999 MHz
			4	7		40.000~60.000 MHz
ASD6 (1.0V)		1.0	2.5	mA	25.000 MHz	
Symmetry @ 1/2Vdd	40		60	%	STD (See option)	
Output Load:			15	pF	CMOS	
Output Voltage (VOH):	0.9* Vdd			V		
Output Voltage (VOL):			0.1* Vdd	V		



# HCMOS SMD Crystal Oscillator

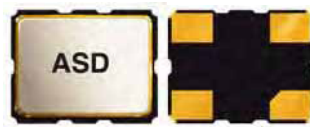

**ASD SERIES**



RoHS/RoHS II compliant

2.5 X 2.0 X 1.0 mm

(Continued)

Parameters		Minimum	Typical	Maximum	Units	Notes
Rise and Fall Time (Tr/Tf):	ASD (3.3V)		3	7	ns	0.750~15.999 MHz
			2.5	6		16.000~39.999 MHz
			2	4		40.000~60.000 MHz
	ASD1 (3.0V)		3	7	ns	0.750~15.999 MHz
			2.5	6		16.000~39.999 MHz
			2	4		40.000~60.000 MHz
	ASD2 (2.5V)		4	8	ns	0.750~15.999 MHz
			3	7		16.000~39.999 MHz
			2.5	5		40.000~60.000 MHz
	ASD3 (1.8V)		5	10	ns	0.750~15.999 MHz
			3.5	8		16.000~39.999 MHz
			3	6		40.000~60.000 MHz
ASD6 (1.0V)		1.9	6.0	ns	25.000 MHz	
Start-up Time:	ASD (3.3V)		6	10	ms	0.750~15.999 MHz
			6	10		16.000~39.999 MHz
			5	10		40.000~60.000 MHz
	ASD1 (3.0V)		6	10	ms	0.750~15.999 MHz
			6	10		16.000~39.999 MHz
			5	10		40.000~60.000 MHz
	ASD2 (2.5V)		6	10	ms	0.750~15.999 MHz
			6	10		16.000~39.999 MHz
			5	10		40.000~60.000 MHz
	ASD3 (1.8V)		6	10	ms	0.750~15.999 MHz
			6	10		16.000~39.999 MHz
			5	10		40.000~60.000 MHz
ASD6 (1.0V)		2.0	10	ms	25.000 MHz	
Tri-state function (Stand-by) :		"1" (VIH≥0.7*Vdd) or Open: Oscillation; "0" (VIH<0.3*Vdd) : No oscillation/Hi Z				
Phase Jitter (12kHz to 20MHz)	ASD (3.3V)		0.4	1.0	ps	0.750~15.999 MHz
			0.4	1.0		16.000~39.999 MHz
			0.3	1.0		40.000~60.000 MHz
	ASD1 (3.0V)		0.4	1.0	ps	0.750~15.999 MHz
			0.4	1.0		16.000~39.999 MHz
			0.3	1.0		40.000~60.000 MHz
	ASD2 (2.5V)		0.5	1.0	ps	0.750~15.999 MHz
			0.5	1.0		16.000~39.999 MHz
			0.5	1.0		40.000~60.000 MHz
	ASD3 (1.8V)		0.5	1.0	ps	0.750~15.999 MHz
			0.5	1.0		16.000~39.999 MHz
			0.5	1.0		40.000~60.000 MHz
ASD6 (1.0V)		0.3	1.0	ps	25.000 MHz	
Period Jitter RMS	ASD (3.3V)		3.0	5.0	ps	0.750~15.999 MHz
			3.0	5.0		16.000~39.999 MHz
			3.0	5.0		40.000~60.000 MHz
	ASD1 (3.0V)		3.0	5.0	ps	0.750~15.999 MHz
			3.0	5.0		16.000~39.999 MHz
			3.0	5.0		40.000~60.000 MHz
	ASD2 (2.5V)		3.0	5.0	ps	0.750~15.999 MHz
			3.0	5.0		16.000~39.999 MHz
			3.0	5.0		40.000~60.000 MHz
	ASD3 (1.8V)		3.0	5.0	ps	0.750~15.999 MHz
			3.0	5.0		16.000~39.999 MHz
			3.0	5.0		40.000~60.000 MHz
ASD6 (1.0V)		4.8	6.0	ps	25.000 MHz	
Aging at 25°C/year		-5		+5	ppm	
Disable Current:				20	µA	

# HCMOS SMD Crystal Oscillator



2.5 X 2.0 X 1.0 mm

## ASD SERIES

### OPTIONS AND PART IDENTIFICATION:

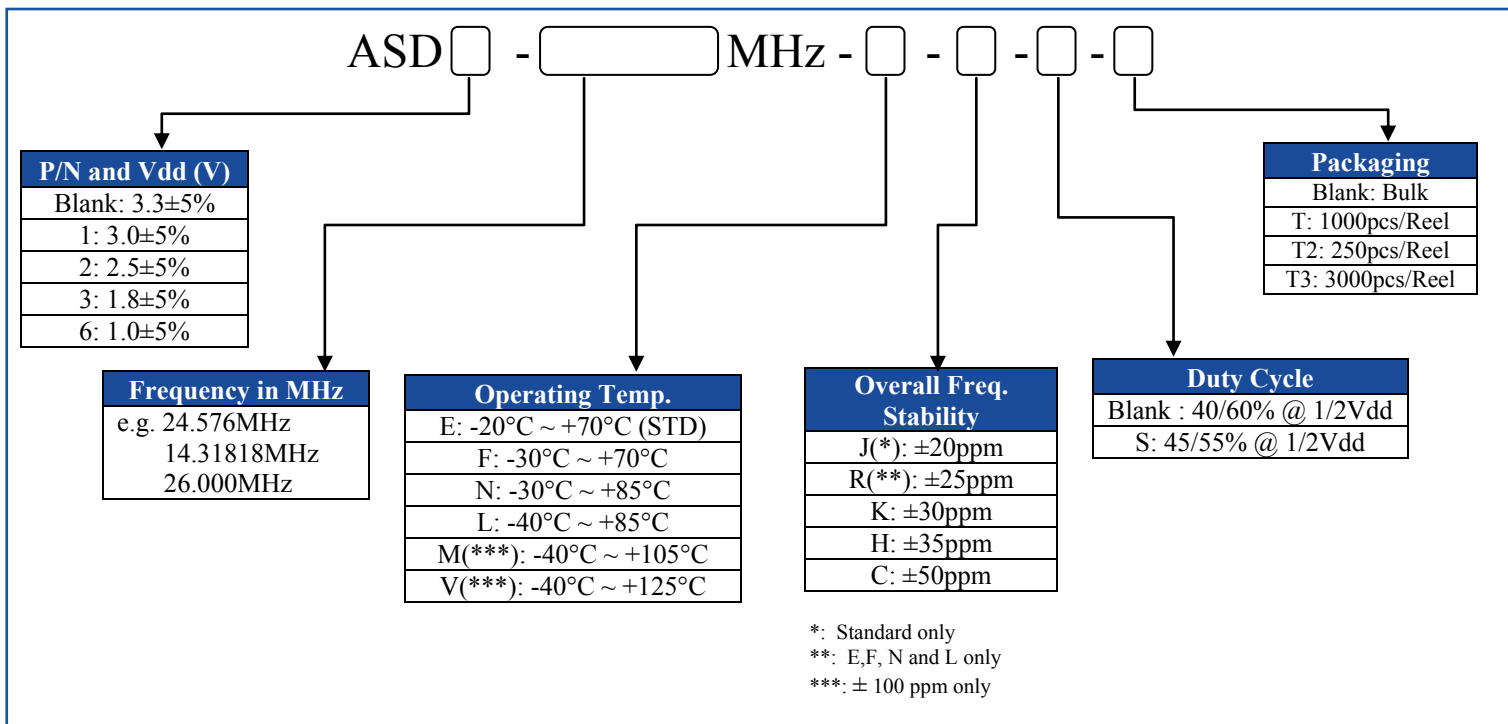

### OUTLINE DRAWING:

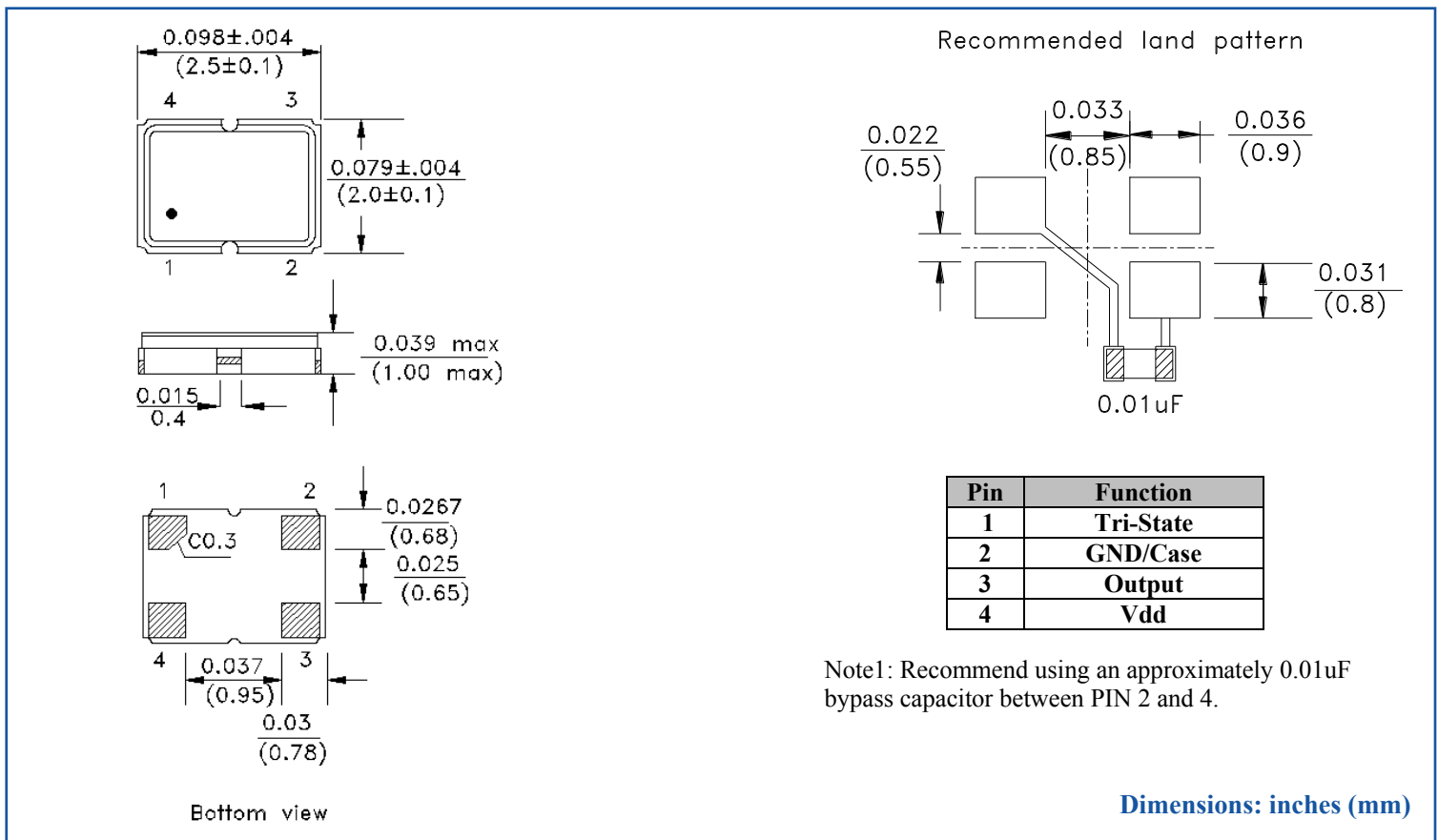

# HCMOS SMD Crystal Oscillator

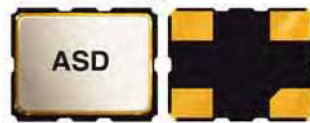

ASD

2.5 X 2.0 X 1.0 mm

ASD SERIES

## TAPE & REEL:

T: 1000pcs/reel  
T2: 250pcs/reel  
T3: 3000pcs/reel

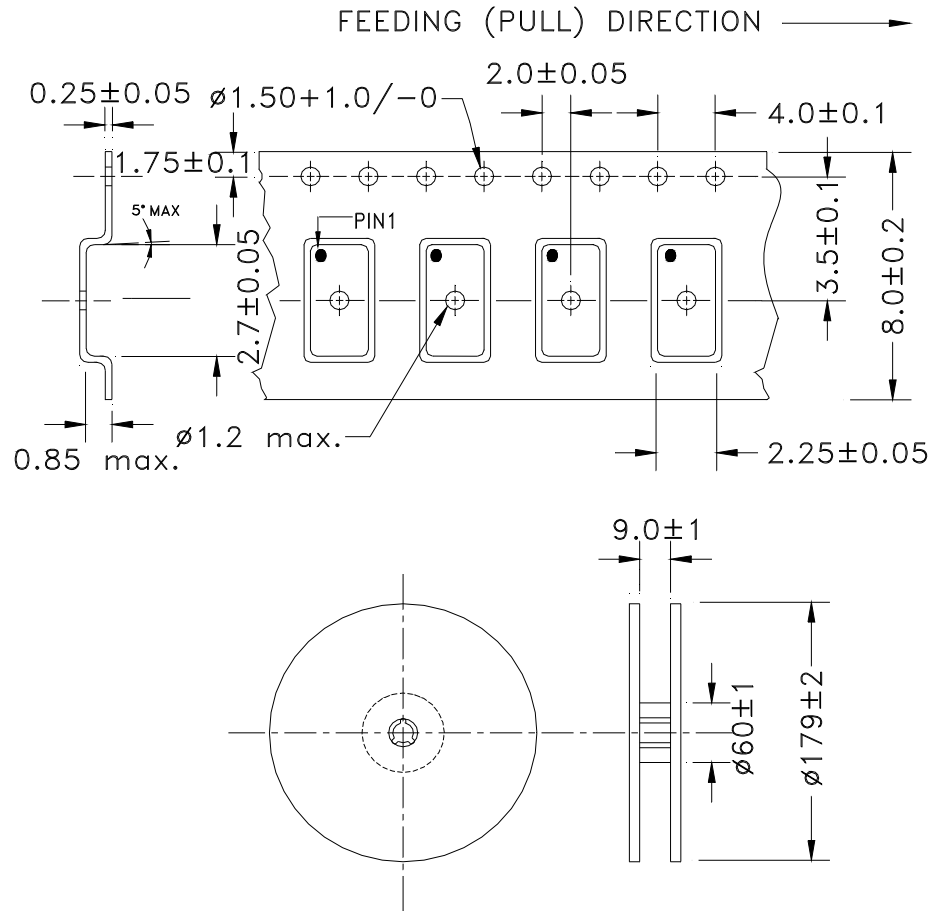

Dimensions: mm

## REFLOW PROFILE:

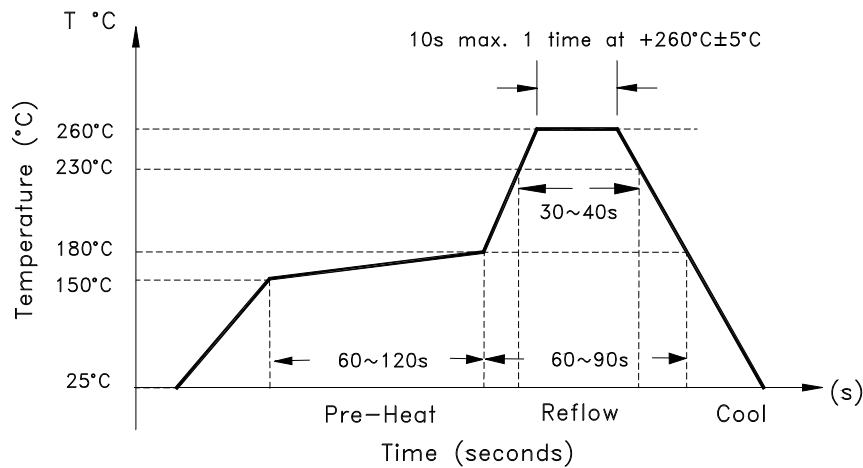

**ATTENTION:** Abracon Corporation's products are COTS – Commercial-Off-The-Shelf products; suitable for Commercial, Industrial and, where designated, Automotive Applications. Abracon's products are not specifically designed for Military, Aviation, Aerospace, Life-dependant Medical applications or any application requiring high reliability where component failure could result in loss of life and/or property. For applications requiring high reliability and/or presenting an extreme operating environment, written consent and authorization from Abracon Corporation is required. Please contact Abracon Corporation for more information.

Need a test socket for the ASD Series? To view compatible **PRECISION TEST & BURN-IN SOCKETS** for these parts, [click here. P/N AXS-2520-04-01](#)



ABRACON IS  
ISO9001:2008  
CERTIFIED



Visit [www.abracon.com](http://www.abracon.com) for Terms & Conditions of Sale **Revised: 01.19.15**  
30332 Esperanza, Rancho Santa Margarita, California 92688  
tel 949-546-8000 | fax 949-546-8001 | [www.abracon.com](http://www.abracon.com)

## Looking for pricing, stock, or lifecycle information?

Click below to explore more details on WIN SOURCE:

-  [View ASD1-30.000MHZ-LR-T on WIN SOURCE](#)
-  [Abracon LLC Information](#)

## Optimize Your Supply Chain with WIN SOURCE Solutions

-  Global Sourcing Solution
-  Obsolete Management
-  Cost Control Management
-  Shortage Management
-  Alternative Solution
-  Excess Inventory Management