



**THE DATASHEET OF
W42180-07-U3-BA**





X42180-07

Z-Power series is designed for high current operation and high flux output applications.



Z-Power LED's thermal performance exceeds other power LED solutions.

It incorporates state of the art SMD design and Thermal emission material.

Z Power LED is ideal light sources for general illumination applications, custom designed solutions, automotive and large LCD backlights.

X42180-07

Features

- Super high flux output and high luminance
- Designed for high current operation
- Low thermal resistance
- SMT solderable
- Lead free product
- RoHS compliant

Applications

- Mobile phone flash
- Automotive interior / Exterior lighting
- Automotive signal lighting
- Automotive forward lighting
- Torch
- Architectural lighting
- LCD TV / Monitor backlight
- Projector light source
- Traffic signals
- Task lighting
- Decorative / Pathway lighting
- Remote / Solar powered lighting
- Household appliances

*The appearance and specifications of the product may be changed for improvement without notice.

Rev. 20

FEBRUARY. 2013

www.seoulsemicon.com



Full Code of Z-Power LED Series

Full code form : X₁ X₂ X₃ X₄ X₅ X₆ X₇ - X₈ X₉ - X₁₀ X₁₁ X₁₂ X₁₃ X₁₄

1. Part Number

- X₁ : Color
- X₂ : Z-Power LED series number
- X₃ : LENS type
- X₄ : Chip quantity (or Power Dissipation)
- X₅ : Package outline size
- X₆ : Type of PCB
- X₇ : Grade of characteristic code

2. Internal Number

- X₈, X₉ : Revision No.

3. Code Labeling

- X₁₀ : Luminous flux (or Radiant flux for royal blue)
- X₁₁ X₁₂ X₁₃ : Dominant wavelength (or x,y coordinates rank code)
- X₁₄ : Forward voltage

4. Sticker Diagram on Reel & Aluminum Vinyl Bag

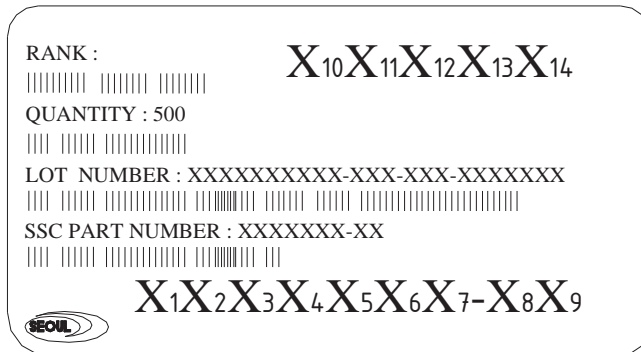

For more information about binning and labeling, refer to the Application Note -1

Outline Dimension

1. Dome Type

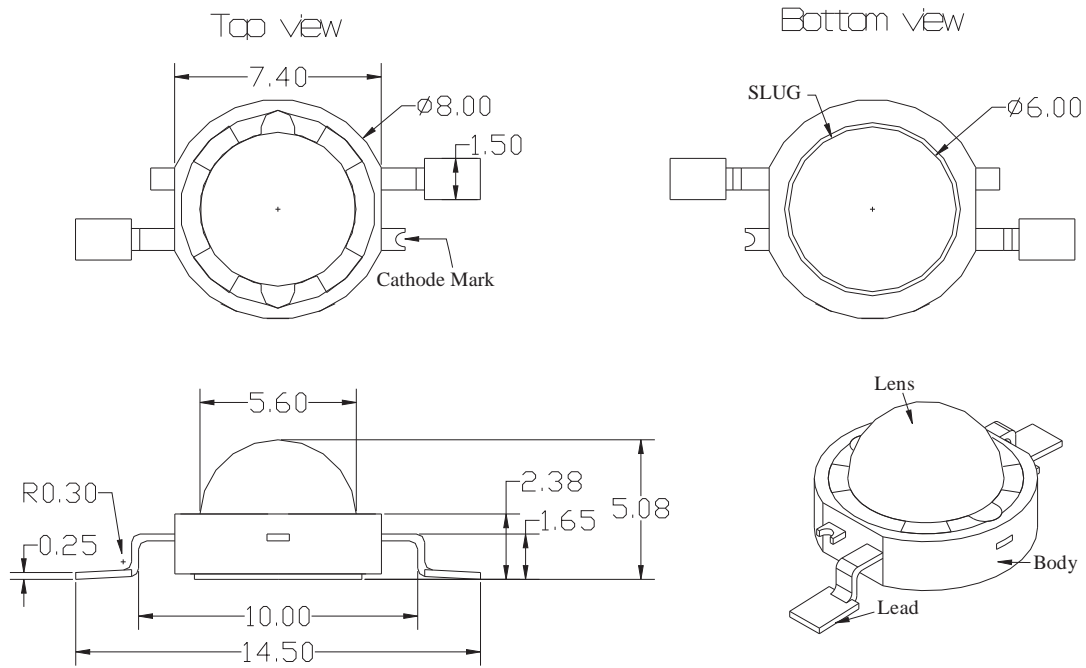

Notes :

1. All dimensions are in millimeters. (tolerance : ± 0.2)
2. Scale : none
3. Slug of package is connected to anode.

*The appearance and specifications of the product may be changed for improvement without notice.

Characteristics for Z-Power LED

1. Pure White (W42180-07)

1-1 Electro-Optical characteristics at $I_F=350\text{mA}$, $T_A=25^\circ\text{C}$

Parameter	Symbol	Value			Unit	
		Min	Typ	Max		
Luminous Flux [1]	T rank	Φ_V [2]	70	80	91	lm
	U rank	Φ_V [2]	91	108	118.5	lm
Correlated Color Temperature [3]	CCT	-	6300	-	K	
CRI	R_a	-	73	-	-	
Forward Voltage [4]	V_F	-	3.1	-	V	
View Angle	$2\theta_{1/2}$	127			deg.	
Thermal resistance [5]	$R\theta_{J-B}$	10.1			$^\circ\text{C}/\text{W}$	
Thermal resistance [6]	$R\theta_{J-C}$	8.5			$^\circ\text{C}/\text{W}$	

1-2 Absolute Maximum Ratings

Parameter	Symbol	Value	Unit
Forward Current	I_F	800	mA
Power Dissipation	P_d	3.28	W
Junction Temperature	T_j	145	$^\circ\text{C}$
Operating Temperature	T_{opr}	-40 ~ +85	$^\circ\text{C}$
Storage Temperature	T_{stg}	-40 ~ +100	$^\circ\text{C}$
ESD Sensitivity [7]	-	$\pm 10,000\text{V HBM}$	-

*Notes :

- [1] SSC maintains a tolerance of $\pm 10\%$ on flux and power measurements.
- [2] Φ_V is the total luminous flux output as measured with an integrating sphere.
- [3] Correlated Color Temperature is derived from the CIE 1931 Chromaticity diagram.
CCT $\pm 5\%$ tester tolerance.
- [4] A tolerance of $\pm 0.06\text{V}$ on forward voltage measurements
- [5], [6] $R\theta_{J-B}$ is measured with a SSC metal core pcb. ($25^\circ\text{C} \leq T_j \leq 110^\circ\text{C}$)
 $R\theta_{J-C}$ is measured with only emitter. ($25^\circ\text{C} \leq T_j \leq 110^\circ\text{C}$)
- [7] It is included the zener chip to protect the product from ESD.

-----Caution-----

- 1. Please do not drive at rated current more than 5 sec. without proper heat sink.

Rev. 20

FEBRUARY. 2013

www.seoulsemicon.com

Characteristics for Z-Power LED

2. Warm White (N42180-07)

2-1 Electro-Optical characteristics at $I_F=350\text{mA}$, $T_A=25^\circ\text{C}$

Parameter	Symbol	Value			Unit
		Min	Typ	Max	
Luminous Flux ^[1]	Φ_V ^[2]	-	72	-	lm
Correlated Color Temperature ^[3]	CCT	-	3000	-	K
CRI	R_a	-	93	-	-
Forward Voltage ^[4]	V_F	-	3.1	-	V
View Angle	2θ 1/2	126			deg.
Thermal resistance ^[5]	$R\theta_{J-B}$	10.1			$^\circ\text{C}/\text{W}$
Thermal resistance ^[6]	$R\theta_{J-C}$	8.5			$^\circ\text{C}/\text{W}$

2-2 Absolute Maximum Ratings

Parameter	Symbol	Value	Unit
Forward Current	I_F	800	mA
Power Dissipation	P_d	3.28	W
Junction Temperature	T_j	145	$^\circ\text{C}$
Operating Temperature	T_{opr}	-40 ~ +85	$^\circ\text{C}$
Storage Temperature	T_{stg}	-40 ~ +100	$^\circ\text{C}$
ESD Sensitivity ^[7]	-	$\pm 10,000\text{V}$ HBM	-

*Notes :

- [1] SSC maintains a tolerance of $\pm 10\%$ on flux and power measurements.
- [2] Φ_V is the total luminous flux output as measured with an integrating sphere.
- [3] Correlated Color Temperature is derived from the CIE 1931 Chromaticity diagram.
CCT $\pm 5\%$ tester tolerance
- [4] A tolerance of $\pm 0.06\text{V}$ on forward voltage measurements
- [5], [6] $R\theta_{J-B}$ is measured with a SSC metal core pcb. ($25^\circ\text{C} \leq T_j \leq 110^\circ\text{C}$)
 $R\theta_{J-C}$ is measured with only emitter. ($25^\circ\text{C} \leq T_j \leq 110^\circ\text{C}$)
- [7] It is included the zener chip to protect the product from ESD.

-----Caution-----

1. Please do not drive at rated current more than 5 sec. without proper heat sink

Characteristics for Z-Power LED

3. Warm White (N42180H-07)

3-1 Electro-Optical characteristics at $I_F=350\text{mA}$, $T_A=25^\circ\text{C}$

Parameter	Symbol	Value			Unit
		Min	Typ	Max	
Luminous Flux ^[1]	Φ_V ^[2]	-	90	-	lm
Correlated Color Temperature ^[3]	CCT	-	3000	-	K
CRI	R_a	-	80	-	-
Forward Voltage ^[4]	V_F	-	3.1	-	V
View Angle	2θ 1/2	127			deg.
Thermal resistance ^[5]	$R\theta_{J-B}$	10.1			$^\circ\text{C}/\text{W}$
Thermal resistance ^[6]	$R\theta_{J-C}$	8.5			$^\circ\text{C}/\text{W}$

3-2 Absolute Maximum Ratings

Parameter	Symbol	Value	Unit
Forward Current	I_F	800	mA
Power Dissipation	P_d	3.28	W
Junction Temperature	T_j	145	$^\circ\text{C}$
Operating Temperature	T_{opr}	-40 ~ +85	$^\circ\text{C}$
Storage Temperature	T_{stg}	-40 ~ +100	$^\circ\text{C}$
ESD Sensitivity ^[7]	-	$\pm 10,000\text{V HBM}$	-

*Notes :

- [1] SSC maintains a tolerance of $\pm 10\%$ on flux and power measurements.
- [2] Φ_V is the total luminous flux output as measured with an integrating sphere.
- [3] Correlated Color Temperature is derived from the CIE 1931 Chromaticity diagram.
CCT $\pm 5\%$ tester tolerance
- [4] A tolerance of $\pm 0.06\text{V}$ on forward voltage measurements
- [5], [6] $R\theta_{J-B}$ is measured with a SSC metal core pcb. ($25^\circ\text{C} \leq T_j \leq 110^\circ\text{C}$)
 $R\theta_{J-C}$ is measured with only emitter. ($25^\circ\text{C} \leq T_j \leq 110^\circ\text{C}$)
- [7] It is included the zener chip to protect the product from ESD.

-----Caution-----

1. Please do not drive at rated current more than 5 sec. without proper heat sink

Characteristics for Z-Power LED

4. Natural White (S42180-07)

4-1 Electro-Optical characteristics at $I_F=350\text{mA}$, $T_A=25^\circ\text{C}$

Parameter	Symbol	Value			Unit
		Min	Typ	Max	
Luminous Flux [1]	Φ_V [2]	-	76	-	lm
Correlated Color Temperature [3]	CCT	-	4000	-	K
CRI	R_a	-	93	-	-
Forward Voltage [4]	V_F	-	3.1	-	V
View Angle	2θ 1/2	126			deg.
Thermal resistance [5]	$R\theta_{J-B}$	10.1			$^\circ\text{C}/\text{W}$
Thermal resistance [6]	$R\theta_{J-C}$	8.5			$^\circ\text{C}/\text{W}$

4-2 Absolute Maximum Ratings

Parameter	Symbol	Value	Unit
Forward Current	I_F	800	mA
Power Dissipation	P_d	3.28	W
Junction Temperature	T_j	145	$^\circ\text{C}$
Operating Temperature	T_{opr}	-40 ~ +85	$^\circ\text{C}$
Storage Temperature	T_{stg}	-40 ~ +100	$^\circ\text{C}$
ESD Sensitivity [7]	-	$\pm 10,000\text{V HBM}$	-

*Notes :

- [1] SSC maintains a tolerance of $\pm 10\%$ on flux and power measurements.
- [2] Φ_V is the total luminous flux output as measured with an integrating sphere.
- [3] Correlated Color Temperature is derived from the CIE 1931 Chromaticity diagram.
CCT $\pm 5\%$ tester tolerance.
- [4] A tolerance of $\pm 0.06\text{V}$ on forward voltage measurements
- [5], [6] $R\theta_{J-B}$ is measured with a SSC metal core pcb. ($25^\circ\text{C} \leq T_j \leq 110^\circ\text{C}$)
 $R\theta_{J-C}$ is measured with only emitter. ($25^\circ\text{C} \leq T_j \leq 110^\circ\text{C}$)
- [7] It is included the zener chip to protect the product from ESD.

-----Caution-----

1. Please do not drive at rated current more than 5 sec. without proper heat sink

Rev. 20

FEBRUARY. 2013

www.seoulsemicon.com

Characteristics for Z-Power LED

5. Natural White (S42180H-07)

5-1 Electro-Optical characteristics at $I_F=350\text{mA}$, $T_A=25^\circ\text{C}$

Parameter	Symbol	Value			Unit
		Min	Typ	Max	
Luminous Flux [1]	Φ_V [2]	-	98	-	lm
Correlated Color Temperature [3]	CCT	-	4000	-	K
CRI	R_a	-	80	-	-
Forward Voltage [4]	V_F	-	3.1	-	V
View Angle	2θ 1/2	127			deg.
Thermal resistance [5]	$R\theta_{J-B}$	10.1			$^\circ\text{C}/\text{W}$
Thermal resistance [6]	$R\theta_{J-C}$	8.5			$^\circ\text{C}/\text{W}$

5-2 Absolute Maximum Ratings

Parameter	Symbol	Value	Unit
Forward Current	I_F	800	mA
Power Dissipation	P_d	3.28	W
Junction Temperature	T_j	145	$^\circ\text{C}$
Operating Temperature	T_{opr}	-40 ~ +85	$^\circ\text{C}$
Storage Temperature	T_{stg}	-40 ~ +100	$^\circ\text{C}$
ESD Sensitivity [7]	-	$\pm 10,000\text{V HBM}$	-

*Notes :

- [1] SSC maintains a tolerance of $\pm 10\%$ on flux and power measurements.
- [2] Φ_V is the total luminous flux output as measured with an integrating sphere.
- [3] Correlated Color Temperature is derived from the CIE 1931 Chromaticity diagram.
CCT $\pm 5\%$ tester tolerance.
- [4] A tolerance of $\pm 0.06\text{V}$ on forward voltage measurements
- [5], [6] $R\theta_{J-B}$ is measured with a SSC metal core pcb. ($25^\circ\text{C} \leq T_j \leq 110^\circ\text{C}$)
 $R\theta_{J-C}$ is measured with only emitter. ($25^\circ\text{C} \leq T_j \leq 110^\circ\text{C}$)
- [7] It is included the zener chip to protect the product from ESD.

-----Caution-----

1. Please do not drive at rated current more than 5 sec. without proper heat sink

Characteristics for Z-Power LED

6. Blue (B42180-07)

6-1 Electro-Optical characteristics at $I_F=350\text{mA}$, $T_A=25^\circ\text{C}$

Parameter	Symbol	Value			Unit
		Min	Typ	Max	
Luminous Flux [1]	Φ_V [2]	-	22	-	lm
Dominant Wavelength[3]	λ_D	455	465	475	nm
Forward Voltage [4]	V_F	-	3.2	-	V
View Angle	2θ 1/2	130			deg.
Thermal resistance [5]	$R\theta_{J-B}$	10.1			$^\circ\text{C}/\text{W}$
Thermal resistance [6]	$R\theta_{J-C}$	8.5			$^\circ\text{C}/\text{W}$

6-2 Absolute Maximum Ratings

Parameter	Symbol	Value	Unit
Forward Current	I_F	800	mA
Power Dissipation	P_d	3.28	W
Junction Temperature	T_j	145	$^\circ\text{C}$
Operating Temperature	T_{opr}	-40 ~ +85	$^\circ\text{C}$
Storage Temperature	T_{stg}	-40 ~ +100	$^\circ\text{C}$
ESD Sensitivity [7]	-	$\pm 10,000\text{V}$ HBM	-

*Notes :

- [1] SSC maintains a tolerance of $\pm 10\%$ on flux and power measurements.
- [2] Φ_V is the total luminous flux output as measured with an integrating sphere.
- [3] Dominant wavelength is derived from the CIE 1931 Chromaticity diagram.
A tolerance of $\pm 0.5\text{nm}$ for dominant wavelength
- [4] A tolerance of $\pm 0.06\text{V}$ on forward voltage measurements
- [5], [6] $R\theta_{J-B}$ is measured with a SSC metal core pcb. ($25^\circ\text{C} \leq T_j \leq 110^\circ\text{C}$)
 $R\theta_{J-C}$ is measured with only emitter. ($25^\circ\text{C} \leq T_j \leq 110^\circ\text{C}$)
- [7] It is included the zener chip to protect the product from ESD.

-----Caution-----

1. Please do not drive at rated current more than 5 sec. without proper heat sink
2. Blue power light sources represented here are in risk group2(Medium) according to IEC 62471

Rev. 20

FEBRUARY. 2013

www.seoulsemicon.com

Characteristics for Z-Power LED

7. Royal Blue (D42180-07)

7-1 Electro-Optical characteristics at $I_F=350\text{mA}$, $T_A=25^\circ\text{C}$

Parameter	Symbol	Value			Unit
		Min	Typ	Max	
Radiant Power [1]	Φ_V [2]	-	468	-	mW
Dominant Wavelength [3]	λ_D	455	457	460	nm
Forward Voltage [4]	V_F	-	3.2	-	V
View Angle	2θ 1/2	130			deg.
Thermal resistance [5]	$R\theta_{j-B}$	10.1			$^\circ\text{C}/\text{W}$
Thermal resistance [6]	$R\theta_{j-C}$	8.5			$^\circ\text{C}/\text{W}$

7-2 Absolute Maximum Ratings

Parameter	Symbol	Value	Unit
Forward Current	I_F	800	mA
Power Dissipation	P_d	3.28	W
Junction Temperature	T_j	145	$^\circ\text{C}$
Operating Temperature	T_{opr}	-40 ~ +85	$^\circ\text{C}$
Storage Temperature	T_{stg}	-40 ~ +100	$^\circ\text{C}$
ESD Sensitivity [7]	-	$\pm 10,000\text{V}$ HBM	-

*Notes :

- [1] SSC maintains a tolerance of $\pm 10\%$ on flux and power measurements.
- [2] Φ_V is the total Radiant power output as measured with an integrating sphere.
- [3] Correlated Color Temperature is derived from the CIE 1931 Chromaticity diagram.
CCT $\pm 5\%$ tester tolerance
- [4] A tolerance of $\pm 0.06\text{V}$ on forward voltage measurements
- [5], [6] $R\theta_{j-B}$ is measured with a SSC metal core pcb. ($25^\circ\text{C} \leq T_j \leq 110^\circ\text{C}$)
 $R\theta_{j-C}$ is measured with only emitter. ($25^\circ\text{C} \leq T_j \leq 110^\circ\text{C}$)
- [7] It is included the zener chip to protect the product from ESD.

-----Caution-----

1. Please do not drive at rated current more than 5 sec. without proper heat sink
2. Blue power light sources represented here are in risk group2(Medium) according to IEC 62471

Rev. 20

FEBRUARY. 2013

www.seoulsemicon.com



Characteristics for Z-Power LED

8. Photosynthetic Red (P42180-07)

11-1 Electro-Optical characteristics at $I_F=350\text{mA}$, $T_A=25^\circ\text{C}$

Parameter	Symbol	Value			Unit
		Min	Typ	Max	
Radiant Power ^[1]	Φ_V ^[2]	150	240	280	mW
Peak Wavelength ^[3]	λ_p	655	660	665	nm
Forward Voltage ^[4]	V_F	2.0	2.4	3.0	V
View Angle	2θ 1/2	130			deg.
Thermal resistance ^[5]	$R\theta_{J-C}$	9			$^\circ\text{C}/\text{W}$

11-2 Absolute Maximum Ratings

Parameter	Symbol	Value	Unit
Forward Current	I_F	700	mA
Power Dissipation	P_d	2.1	W
Junction Temperature	T_j	125	$^\circ\text{C}$
Operating Temperature	T_{opr}	-40 ~ +85	$^\circ\text{C}$
Storage Temperature	T_{stg}	-40 ~ +100	$^\circ\text{C}$
ESD Sensitivity ^[6]	-	$\pm 10,000\text{V}$ HBM	-

*Notes :

- [1] SSC maintains a tolerance of $\pm 10\%$ on flux and power measurements.
- [2] Φ_V is the total Radiant power output as measured with an integrating sphere.
- [3] Peak wavelength is derived from the CIE 1931 Chromaticity diagram.
A tolerance of $\pm 1\text{nm}$ for peak wavelength
- [4] A tolerance of $\pm 0.06\text{V}$ on forward voltage measurements
- [5] $R\theta_{J-C}$ is measured with only emitter.
- [6] It is included the zener chip to protect the product from ESD.

-----Caution-----
1. Please do not drive at rated current more than 5 sec. without proper heat sink

Color Spectrum, $T_A=25^{\circ}\text{C}$

1. Pure White(W42180-07)

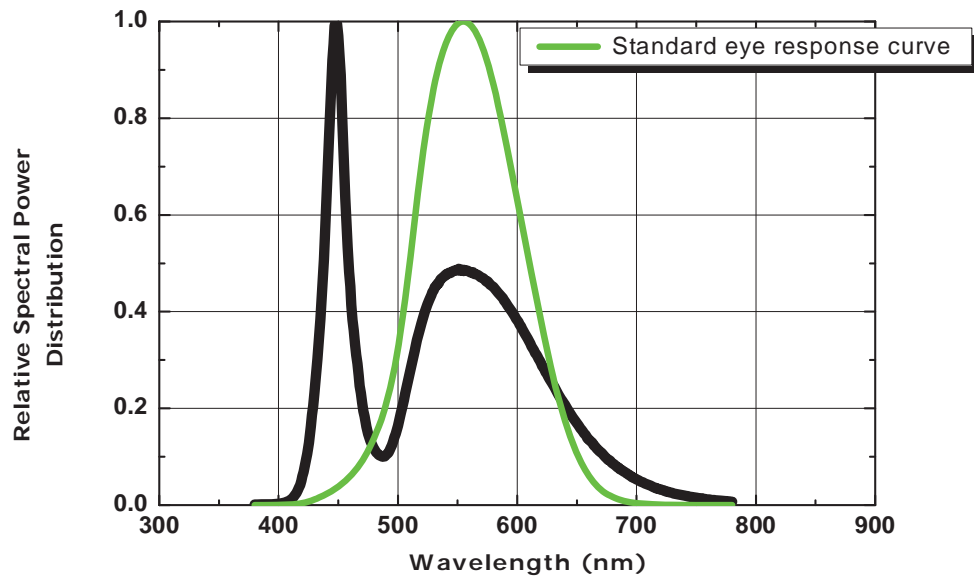

2. Warm White (N42180-07)

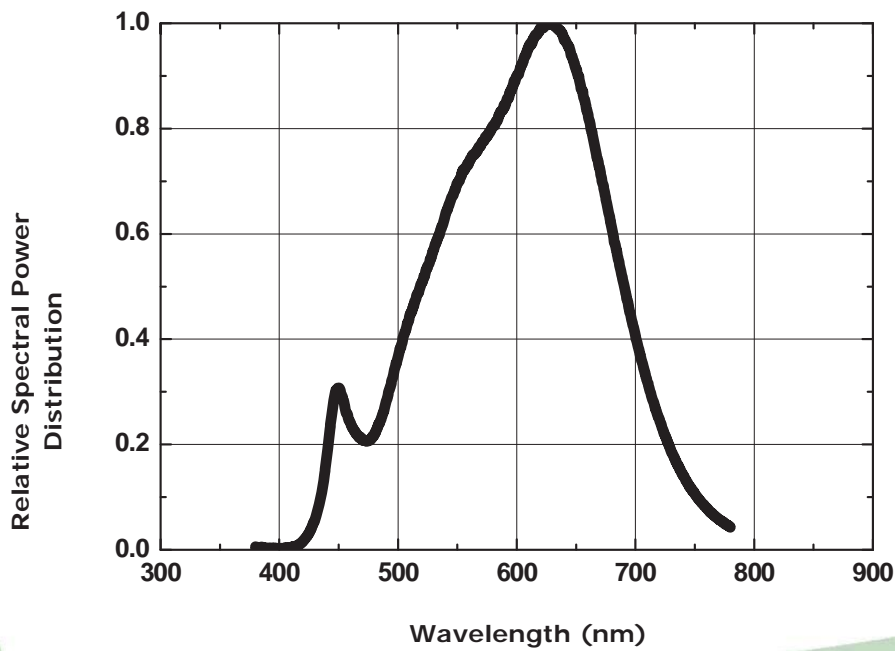

Color Spectrum, $T_A=25^{\circ}\text{C}$

3. Warm White (N42180H-07)

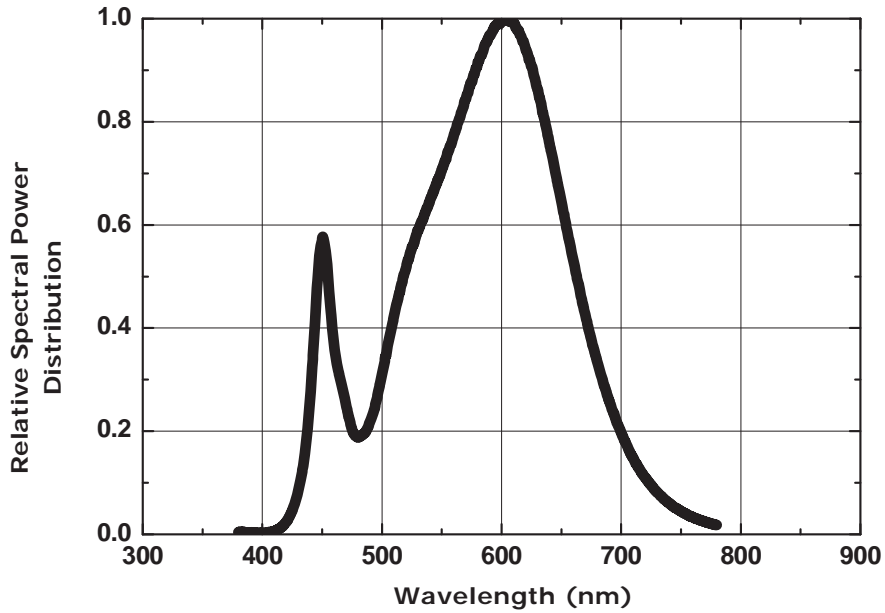

4. Natural White (S42180-07)

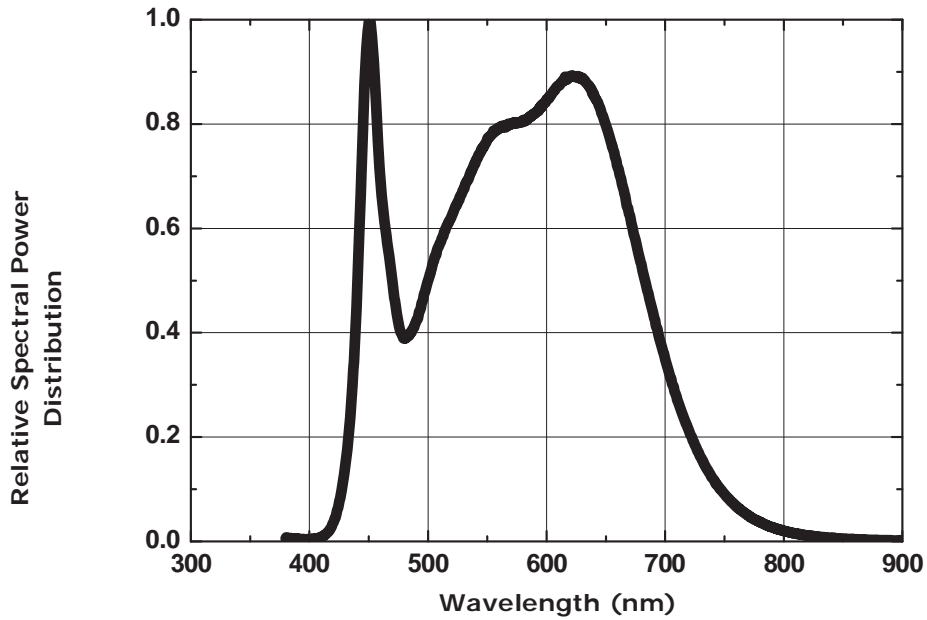

Color Spectrum, $T_A=25^{\circ}\text{C}$

5. Natural White (S42180H)

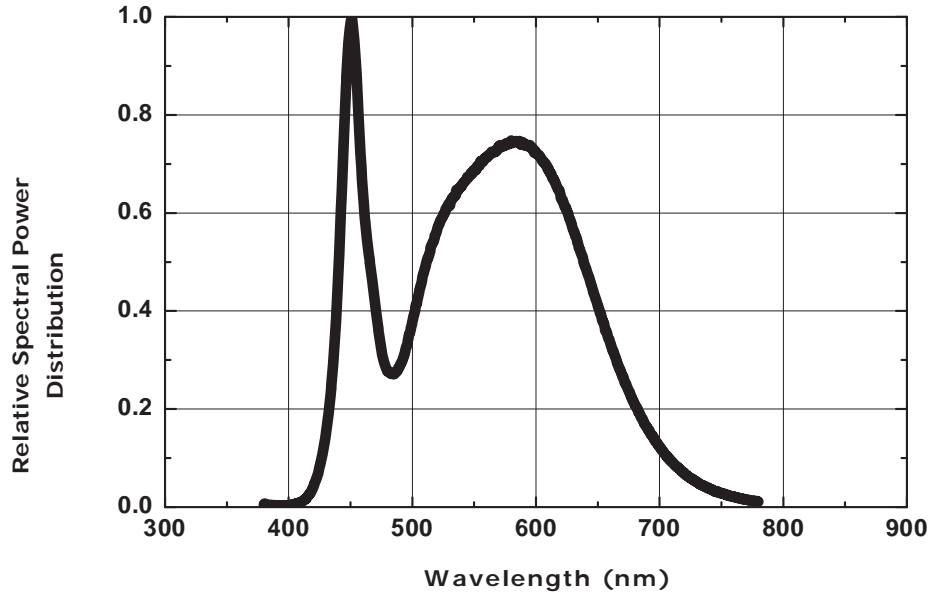

6. Blue(Royal Blue), Photosynthetic Red

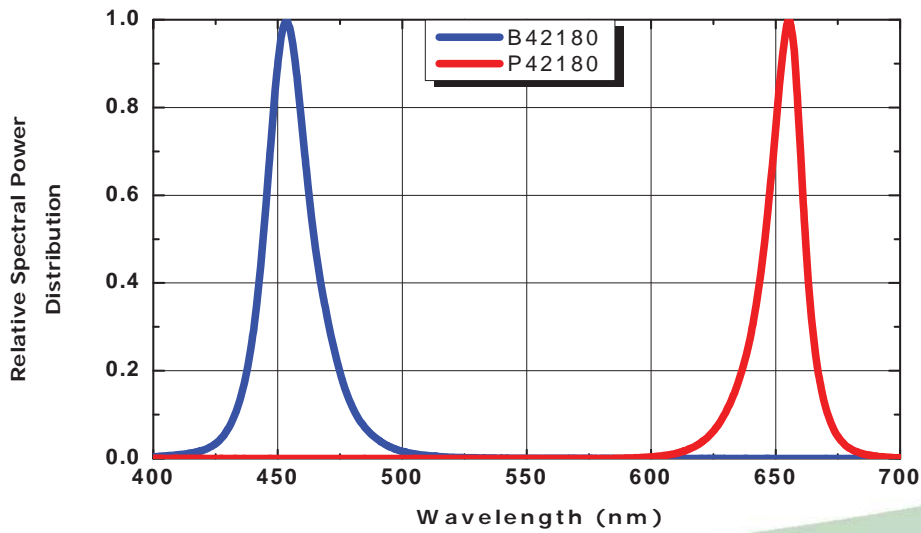

Junction Temperature Characteristics

1. Relative Light Output vs. Junction Temperature at $I_F=350\text{mA}$

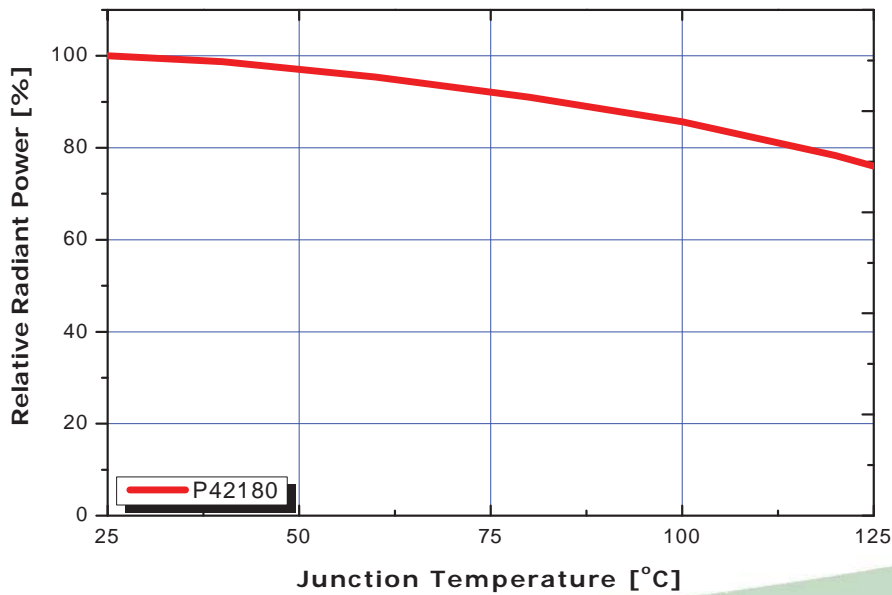
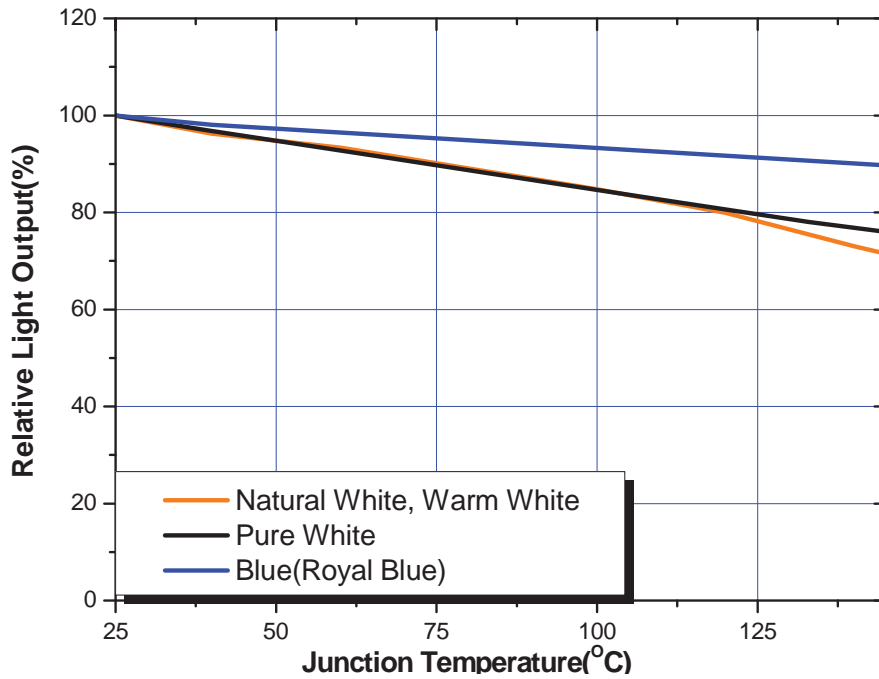

Junction Temperature Characteristics

2. Forward Voltage Shift vs. Junction Temperature at $I_F=350\text{mA}$

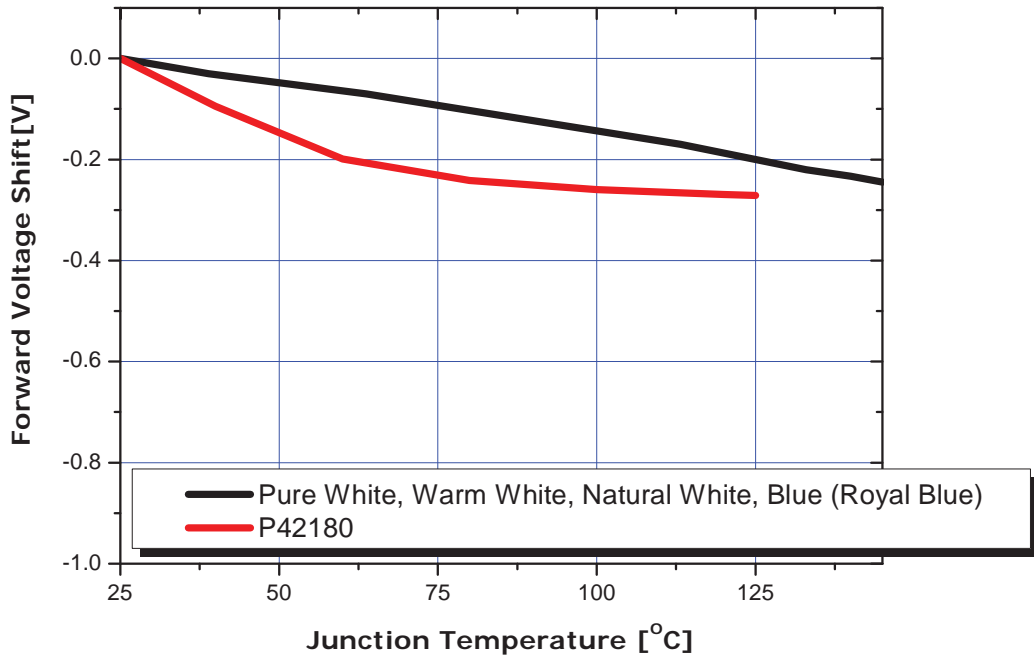

3. Wavelength Shift vs Junction Temperature at $I_F=350\text{mA}$

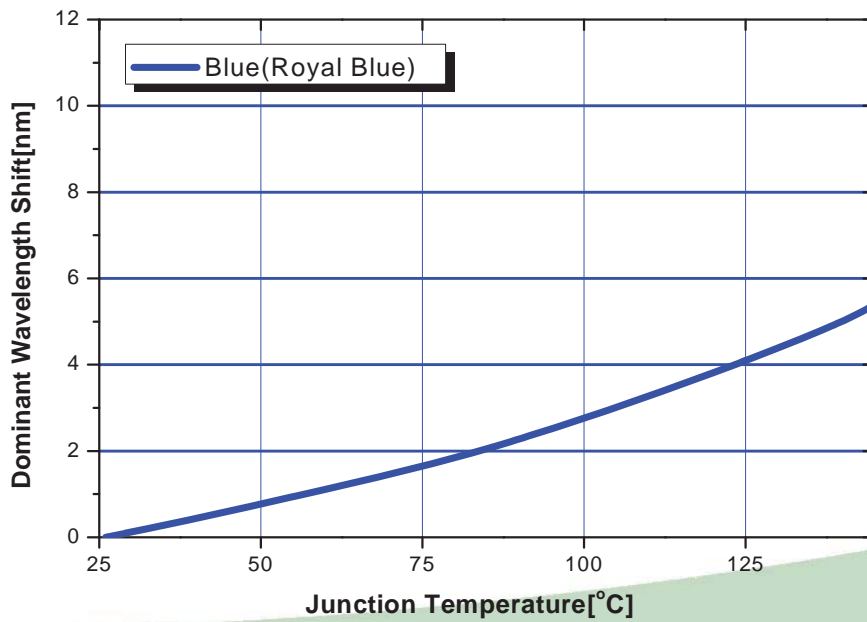

Forward Current Characteristics

1. Forward Voltage vs. Forward Current , $T_A=25\text{ }^\circ\text{C}$

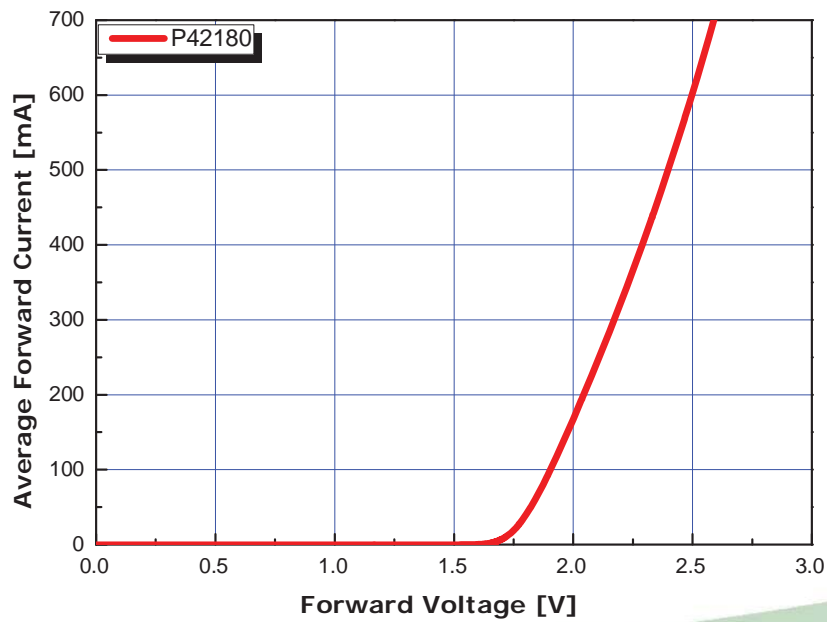
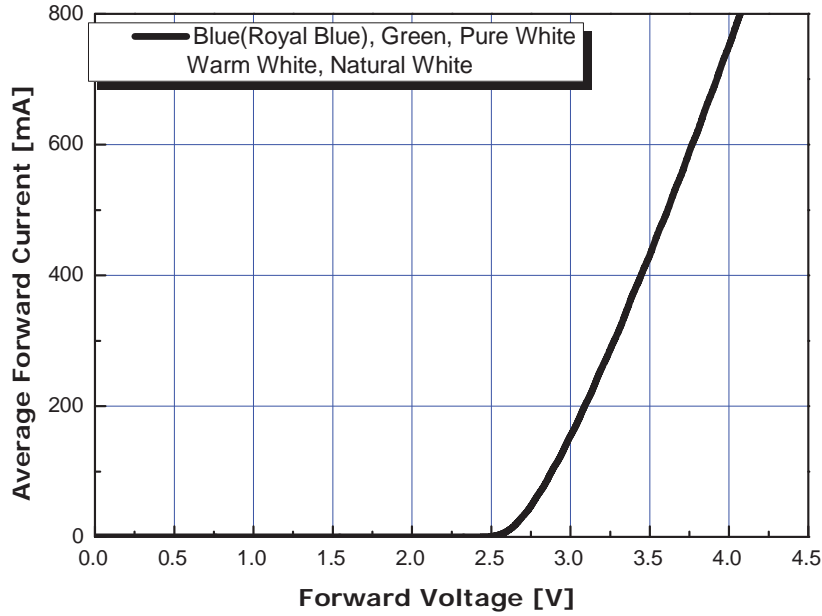

Forward Current Characteristics

2. Forward Current vs. Normalized Relative Luminous Flux, $T_A=25\text{ }^\circ\text{C}$

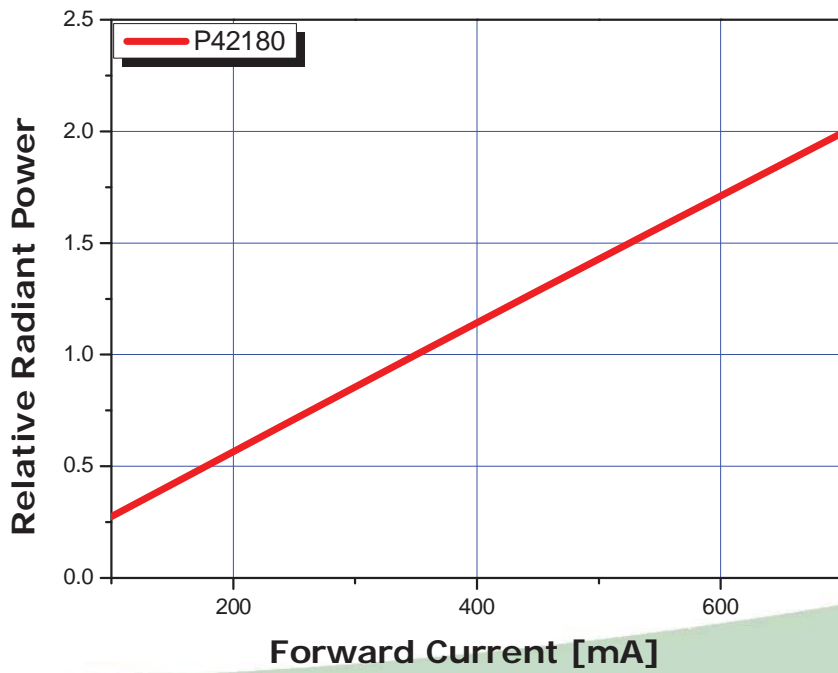
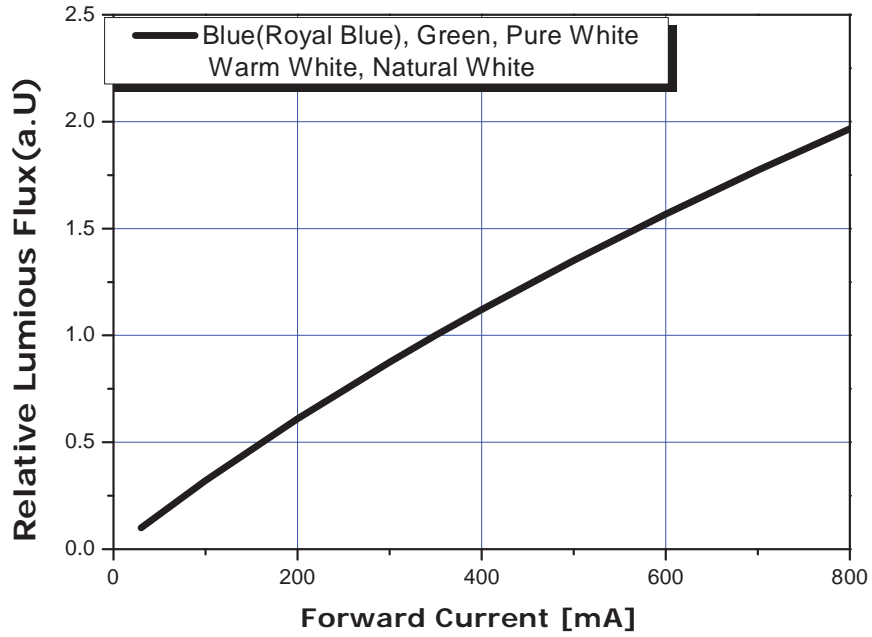

Forward Current Characteristics

3. Forward Current vs Wavelength Shift, $T_A=25\text{ }^\circ\text{C}$

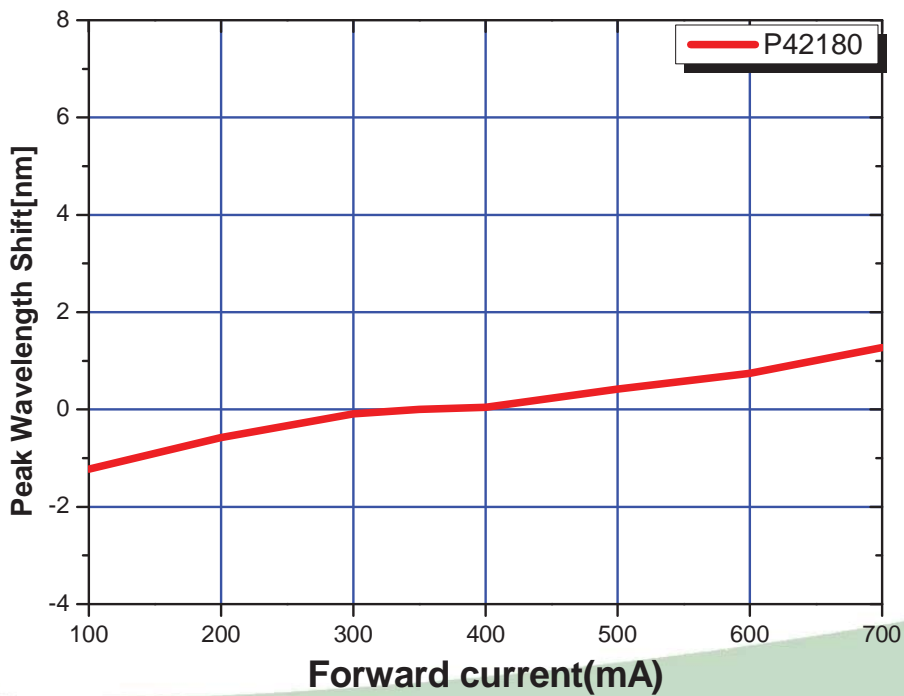
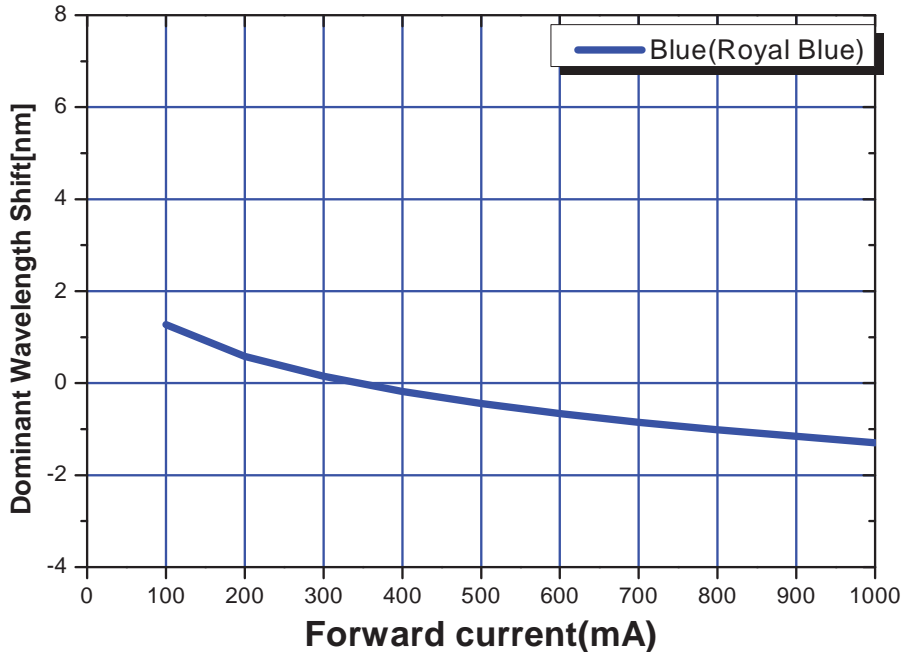

Ambient Temperature vs Allowable Forward Current

1-1. Pure White, Warm White, Natural White, Blue(Royal Blue) ($T_{MAX} = 145\text{ }^{\circ}\text{C}$, @350mA)

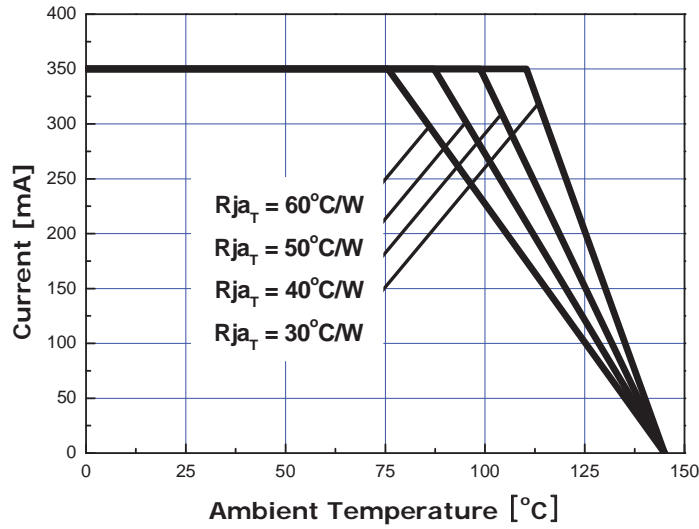

1-2. Pure White, Warm White, Natural White, Blue(Royal Blue) ($T_{MAX} = 145\text{ }^{\circ}\text{C}$, @700mA)

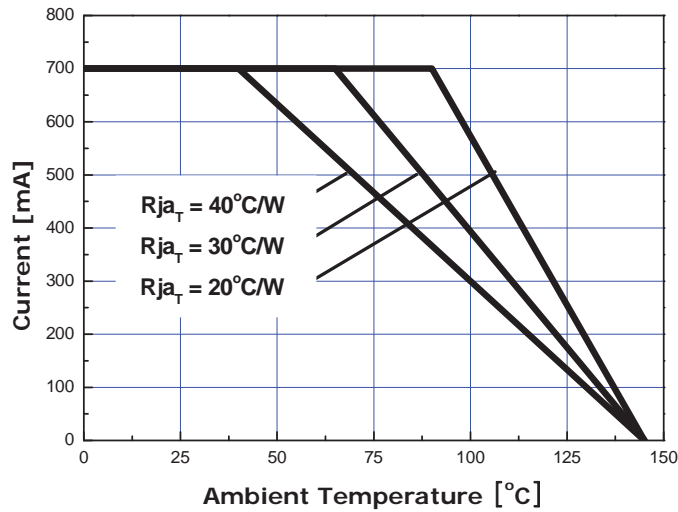

Ambient Temperature vs Allowable Forward Current

1-3. Photosynthetic Red ($T_{JMAX} = 125\text{ }^{\circ}\text{C}$, at 350mA)

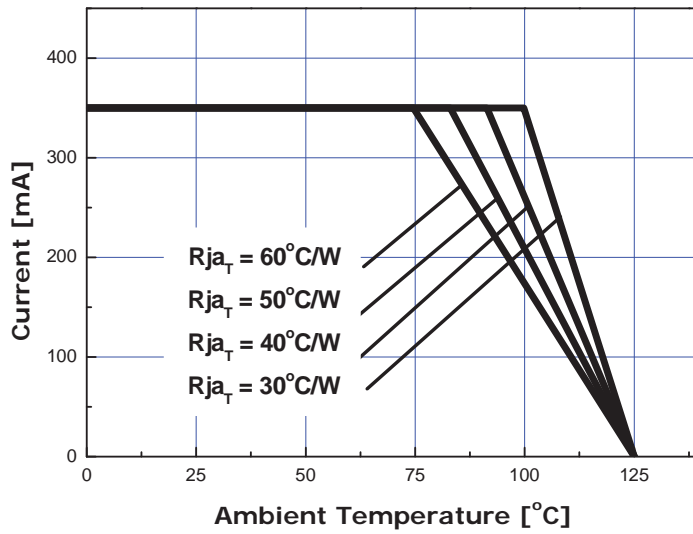

1-4. Photosynthetic Red ($T_{JMAX} = 125\text{ }^{\circ}\text{C}$, @700mA)

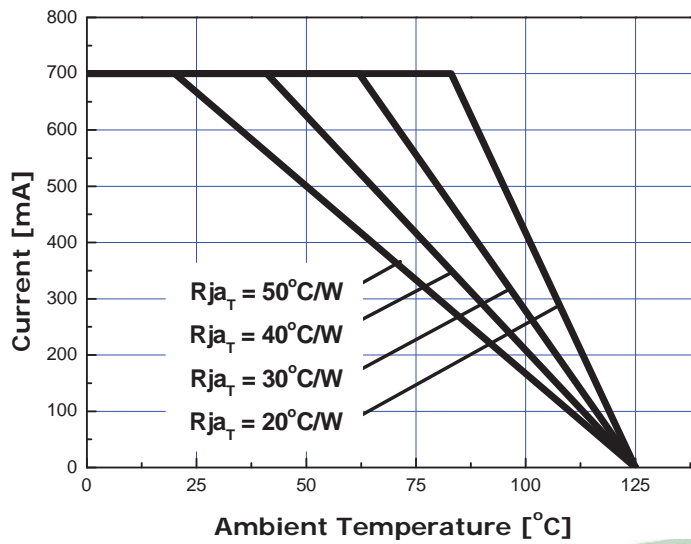

Typical Dome Type Radiation pattern

1. Pure White

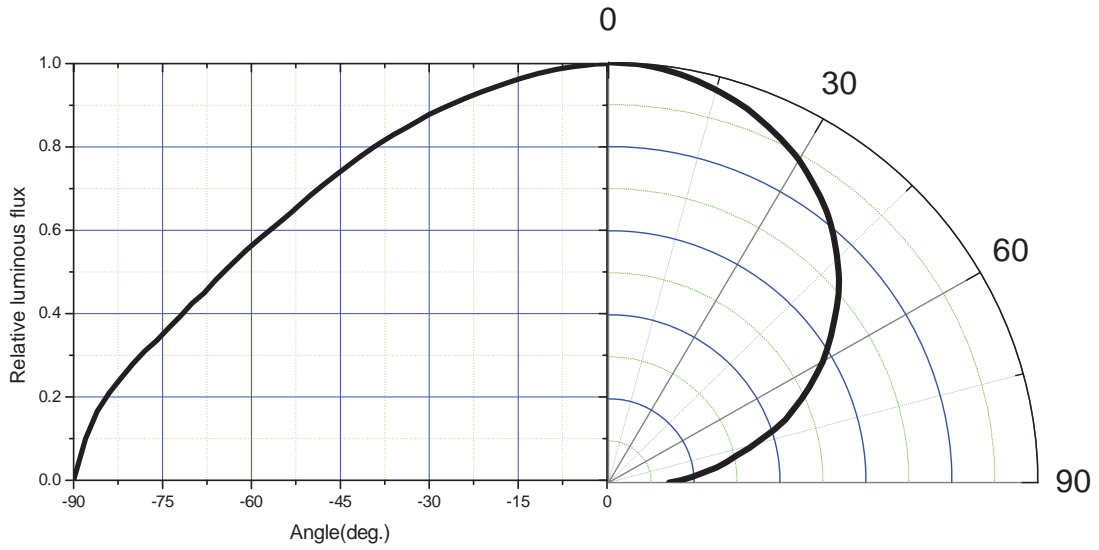

2. Warm White, Natural White

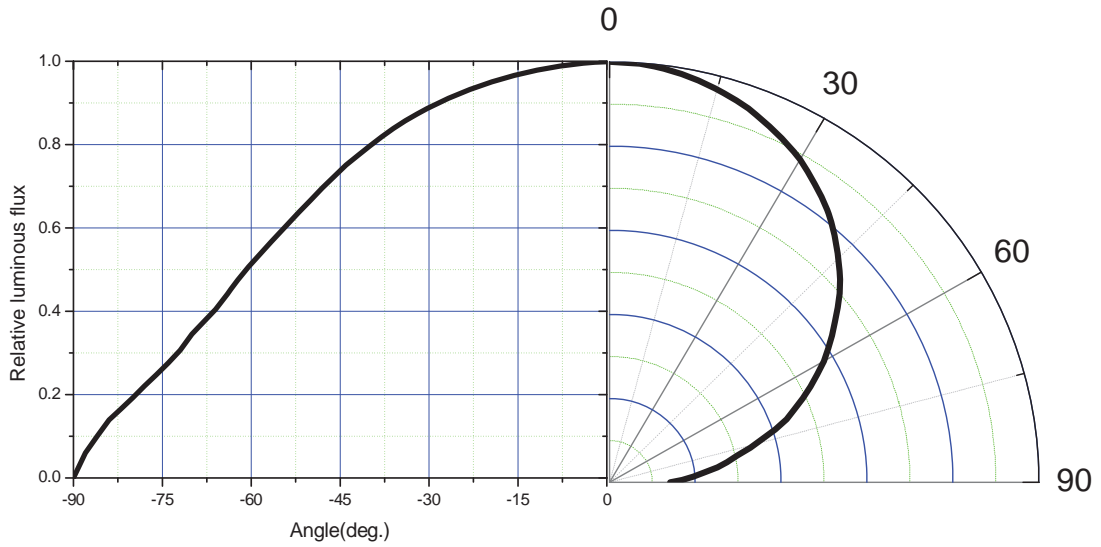

Typical Dome Type Radiation pattern

3. Blue(Royal Blue)

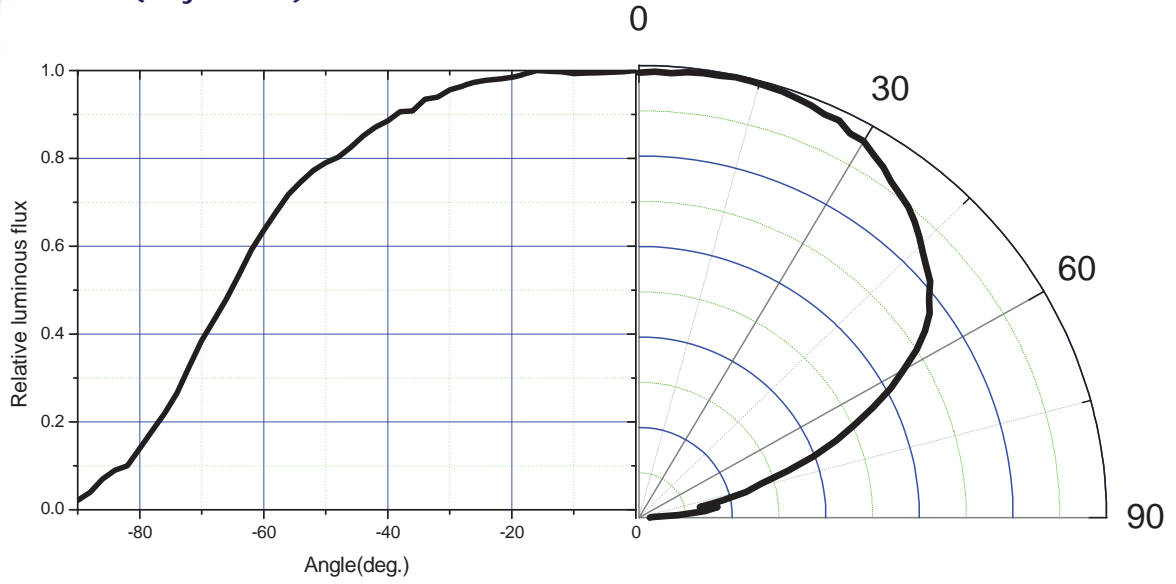

4. Photosynthetic Red

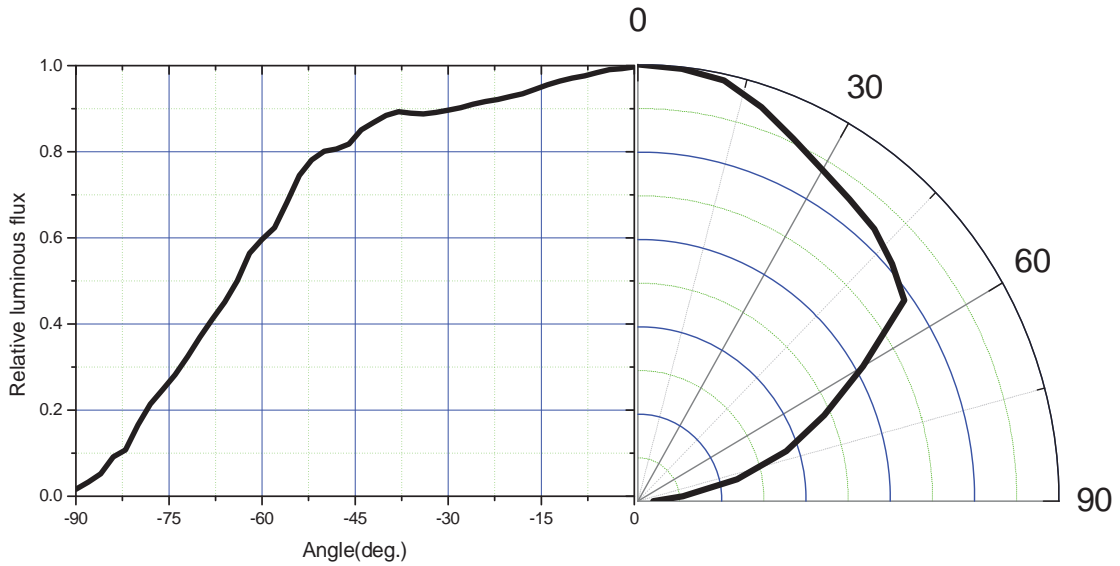

Recommended Solder pad

1. Solder pad

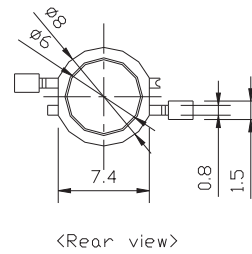
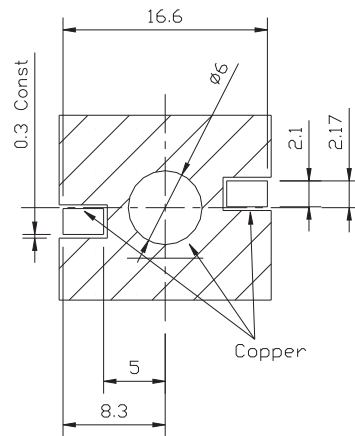
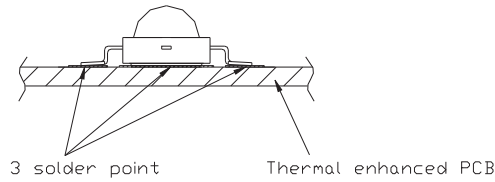

2. Solder paste pattern

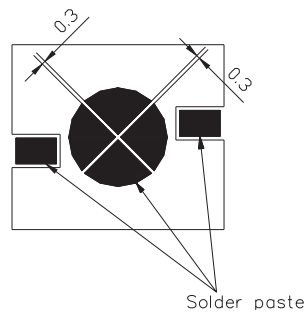

Note :

1. All dimensions are in millimeters (tolerance : ± 0.2)
2. Scale none

*The appearance and specifications of the product may be changed for improvement without notice.

Rev. 20

FEBRUARY. 2013

www.seoulsemicon.com

3. Reflow Soldering Conditions / Profile

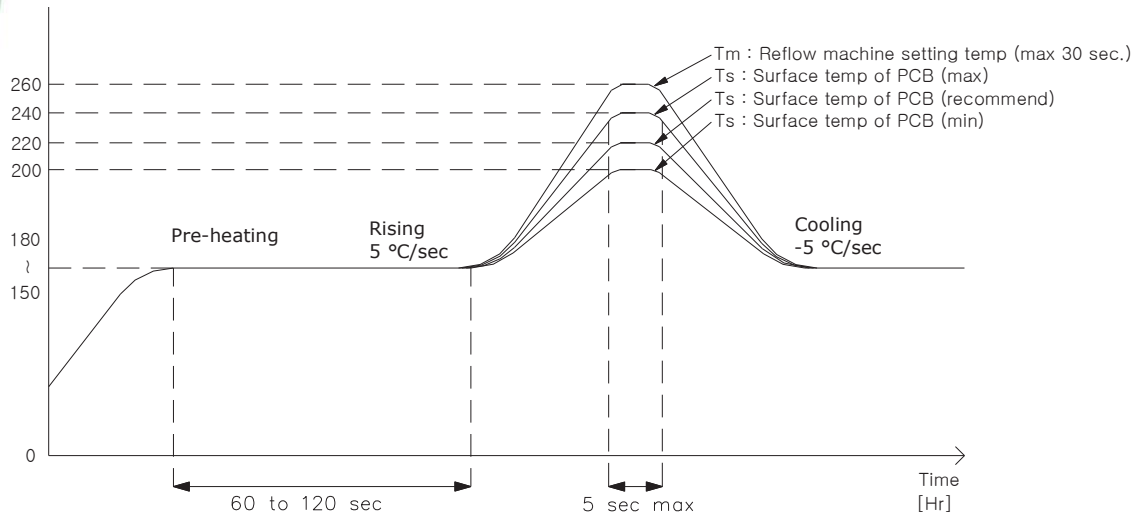

4. Hand Soldering conditions

Lead : Not more than 3 seconds @MAX280 °C

Slug : Use a thermal-adhesives

*** Caution**

1. Reflow soldering should not be done more than one time.
2. Repairing should not be done after the LEDs have been soldered.
When repairing is unavoidable, suitable tools have to be used.
3. The bottom of the emitter is to be soldered.
4. When soldering, do not put stress on the LEDs during heating.
5. After soldering, do not warp the circuit board.
6. Recommend to use a convection type reflow machine with 7 ~ 8 zones.

Emitter Type Reel Packaging

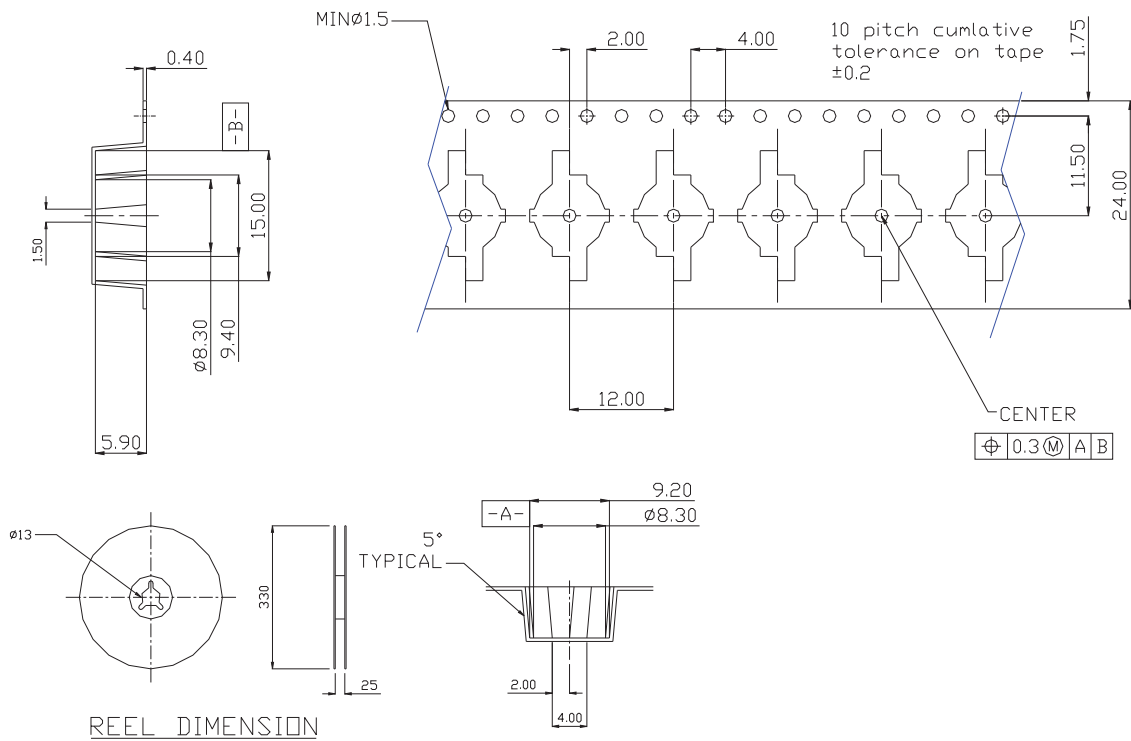

Note :

1. The number of loaded products in the reel is 500ea
2. All dimensions are in millimeters (tolerance : ± 0.2)
3. Scale none

*The appearance and specifications of the product may be changed for improvement without notice.

Rev. 20

FEBRUARY. 2013

www.seoulsemicon.com

Packaging Structure

Aluminum Vinyl Bag

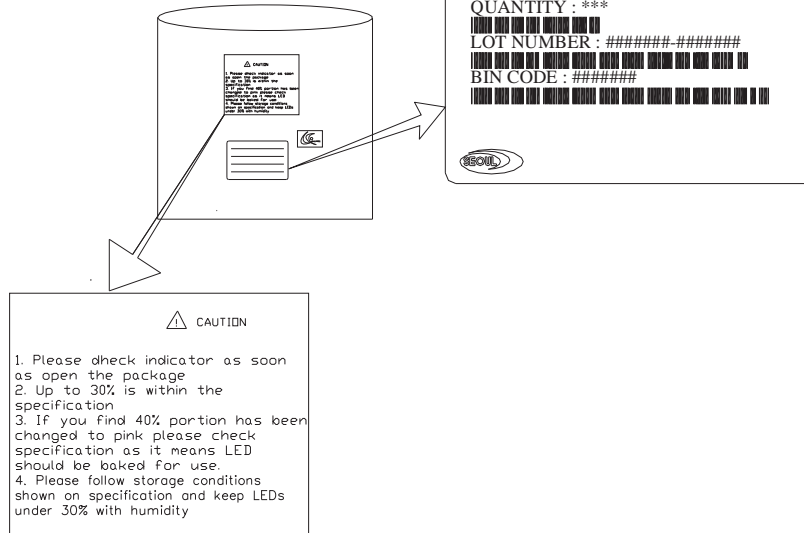

Outer Box

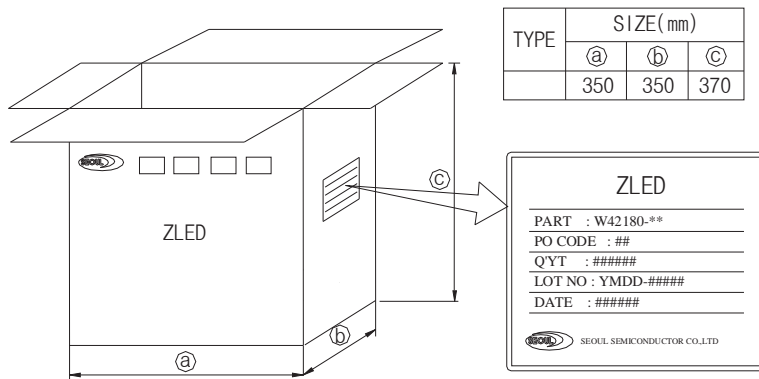

Note :

1. 6~10 reels are loaded in box
2. Scale none
3. For more information about binning and labeling, refer to the Application Note - 1

precaution for use

- Storage
To avoid the moisture penetration, we recommend storing Z Power LEDs in a dry box (or desiccator) with a desiccant . The recommended storage conditions are Temperature 5 to 30 degrees Centigrade. Humidity 50% maximum.
- Precaution after opening packaging
However LED is correspond SMD, when LED be soldered dip, interfacial separation may affect the light transmission efficiency, causing the light intensity to drop.
Attention in followed.
 - a. Soldering should be done right after opening the package(within 24Hrs).
 - b. Keeping of a fraction
 - Sealing
 - Temperature : 5 ~ 40℃ Humidity : less than 30%
 - c. If the package has been opened more than 1week or the color of desiccant changes, components should be dried for 10-12hr at 60±5℃
- Any mechanical force or any excess vibration shall not be accepted to apply during cooling process to normal temp after soldering.
- Please avoid rapid cooling after soldering.
- Components should not be mounted on warped direction of PCB.
- Anti radioactive ray design is not considered for the products listed here in.
- Gallium arsenide is used in some of the products listed in this publication. These products are dangerous if they are burned or shredded in the process of disposal. It is also dangerous to drink the liquid or inhale the gas generated by such products when chemically disposed.
- This device should not be used in any type of fluid such as water, oil, organic solvent and etc. When washing is required, IPA(Isopropyl Alcohol) should be used.
- When the LEDs are illuminating, operating current should be decided after considering the package maximum temperature.
- LEDs must be stored to maintain a clean atmosphere. If the LEDs are stored for 3 months or more after being shipped from SSC, a sealed container with a nitrogen atmosphere should be used for storage.
- The appearance and specifications of the product may be modified for improvement without notice.
- Long time exposure of sunlight or occasional UV exposure will cause lens discoloration.
- The slug is connected to the anode. Therefore, we recommend to isolate the heat sink.
- Attaching LEDs, don't use adhesives to generate organic vapor.

Rev. 20

FEBRUARY. 2013

www.seoulsemicon.com



Handling of Silicone resin LEDs

Z-Power LED is encapsulated by silicone resin for the highest flux efficiency.

Notes for handling of Silicone resin Z-Power LEDs

- Avoid touching silicone resin parts especially by sharp tools such as Pincette(Tweezers)
- Avoid leaving fingerprints on silicone resin parts.
- Dust sensitivity silicone resin need containers having cover for storage.
- When populating boards in SMT production, there are basically no restrictions regarding the form of the pick and place nozzle, except that mechanical pressure on the surface of the resin must be prevent.
- Please do not force over 2000 gf impact or pressure diagonally on the silicon lens.
It will cause fatal damage of this product
- Please do not recommend to cover the silicone resin of the LEDs with other resin (epoxy, urethane, etc)

Please do not mold this product into another resin (epoxy, urethane, etc) and do not handle this product with acid or sulfur material in sealed space.

Looking for pricing, stock, or lifecycle information?

Click below to explore more details on WIN SOURCE:

 [View W42180-07-U3-BA on WIN SOURCE](#)

 [Seoul Semiconductor Inc.](#) Information

Optimize Your Supply Chain with WIN SOURCE Solutions

-  Global Sourcing Solution
-  Obsolete Management
-  Cost Control Management
-  Shortage Management
-  Alternative Solution
-  Excess Inventory Management