



THE DATASHEET OF HMC524LC3BTR





Typical Applications

The HMC524LC3B is ideal for:

- Point-to-Point Radios
- Point-to-Multi-Point Radios & VSAT
- Test Equipment & Sensors
- Military End Use

Features

- Wide IF Bandwidth: DC - 4.5 GHz
- Image Rejection: 20 dB
- LO to RF Isolation: 45 dB
- High Input IP3: +20 dBm
- 12 Lead 3x3mm SMT Package: 9mm²

Functional Diagram

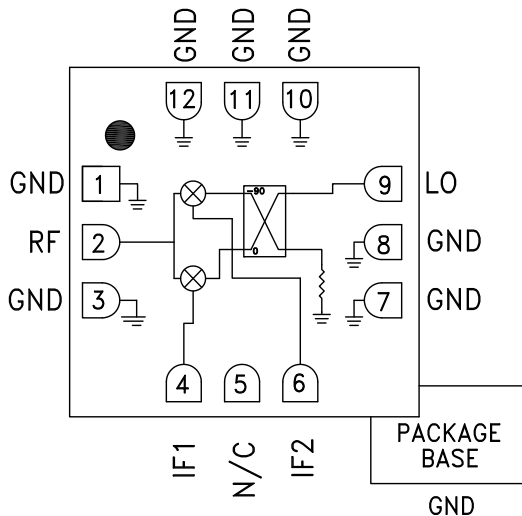

General Description

The HMC524LC3B is a compact I/Q MMIC mixer which can be used as either an Image Reject Mixer or a Single Sideband Upconverter. The chip utilizes standard Hittite mixer cells and a 90 degree hybrid fabricated in a GaAs MESFET process. A low frequency quadrature hybrid was used to produce a 100 MHz USB IF output. This product is a much smaller alternative to hybrid style Image Reject mixers and single sideband upconverter assemblies. The HMC524LC3B eliminates the need for wirebonding, allowing the use of surface mount techniques.

Electrical Specifications, $T_A = +25\text{ }^\circ\text{C}$, $IF = 100\text{ MHz}$, $LO = +17\text{ dBm}^*$

Parameter	Min.	Typ.	Max.	Units
Frequency Range, RF/LO	22 - 32			GHz
Frequency Range, IF	DC - 4.5			GHz
Conversion Loss (As IRM)		10	13	dB
Image Rejection	18	20		dB
1 dB Compression (Input)		+16		dBm
LO to RF Isolation	35	40		dB
LO to IF Isolation	20	30		dB
IP3 (Input)		+20		dBm
Amplitude Balance		± 0.5		dB
Phase Balance		± 2.5		Deg

* Unless otherwise noted, all measurements performed as downconverter.



Data Taken As IRM With External IF Hybrid

Conversion Gain vs. Temperature

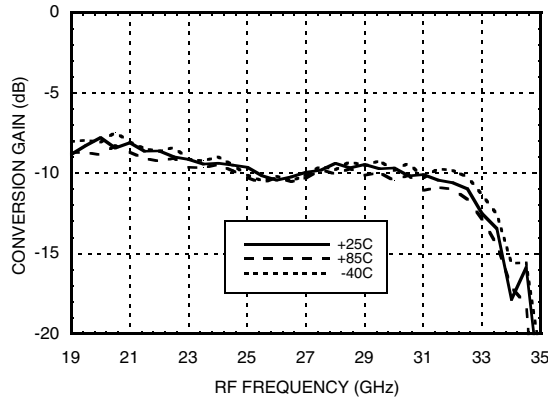
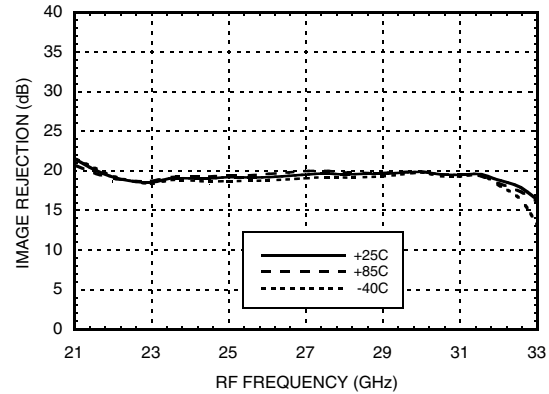
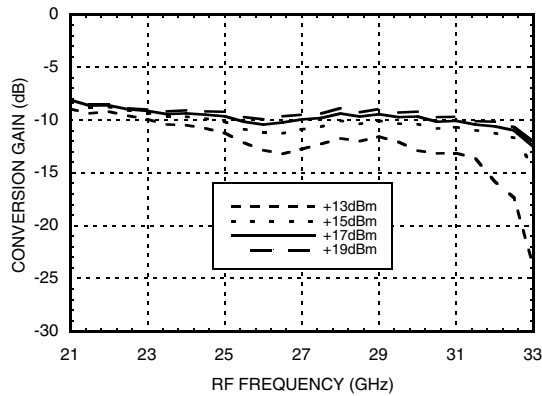

Image Rejection vs. Temperature



Conversion Gain vs. LO Drive



Return Loss

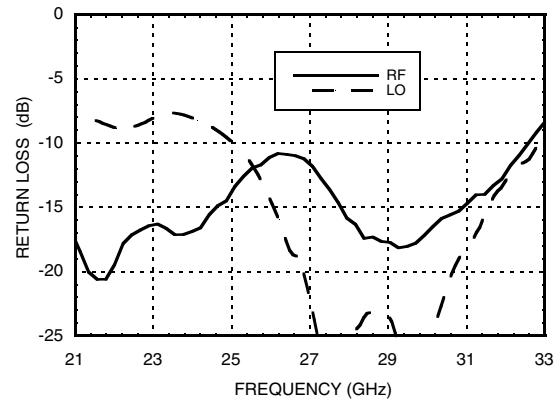

Input P1dB vs. Temperature

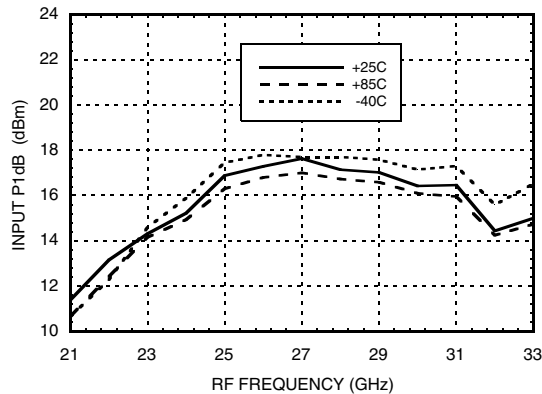

Input IP3 vs. LO Drive

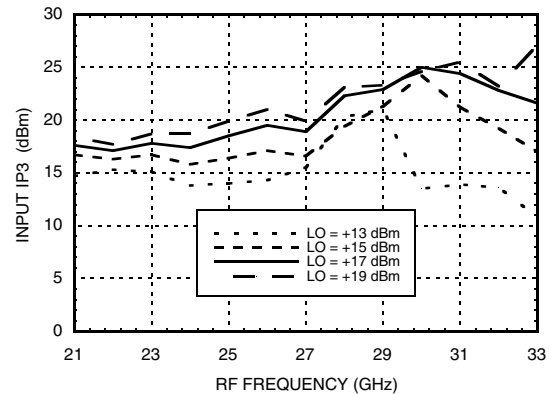

Information furnished by Analog Devices is believed to be accurate and reliable. However, no responsibility is assumed by Analog Devices for its use, nor for any infringements of patents or other rights of third parties that may result from its use. Specifications subject to change without notice. No license is granted by implication or otherwise under any patent or patent rights of Analog Devices. Trademarks and registered trademarks are the property of their respective owners.

For price, delivery, and to place orders: Analog Devices, Inc., One Technology Way, P.O. Box 9106, Norwood, MA 02062-9106 Phone: 781-329-4700 • Order online at www.analog.com Application Support: Phone: 1-800-ANALOG-D



**GaAs MMIC I/Q MIXER
22 - 32 GHz**

Data Taken As IRM With External IF Hybrid

Isolations

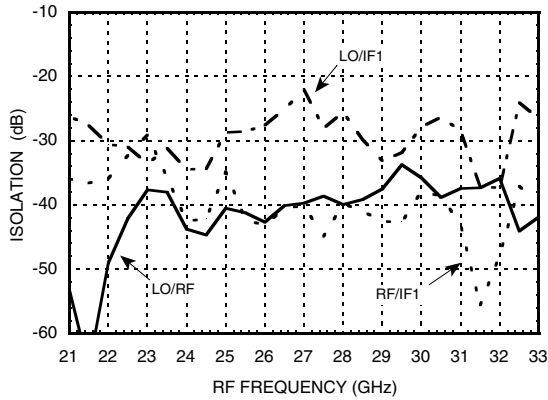

IF Bandwidth

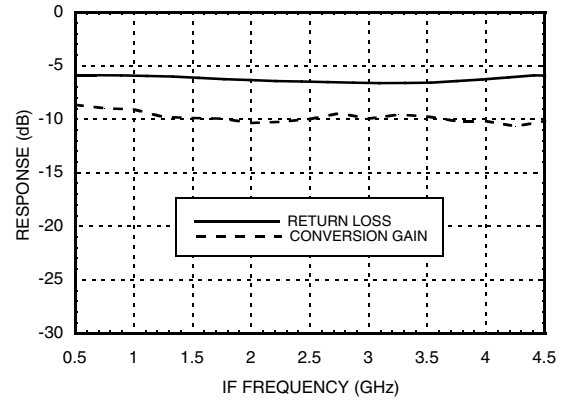

Amplitude Balance vs. LO Drive

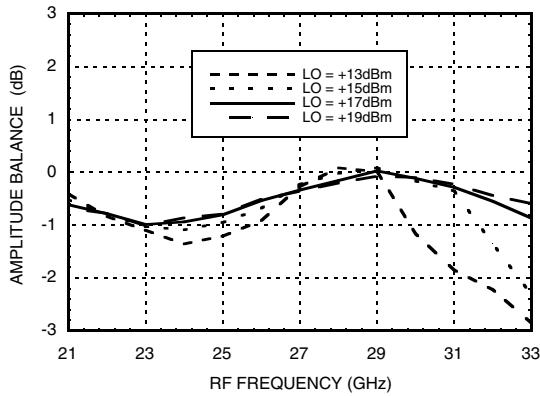

Phase Balance vs. LO Drive

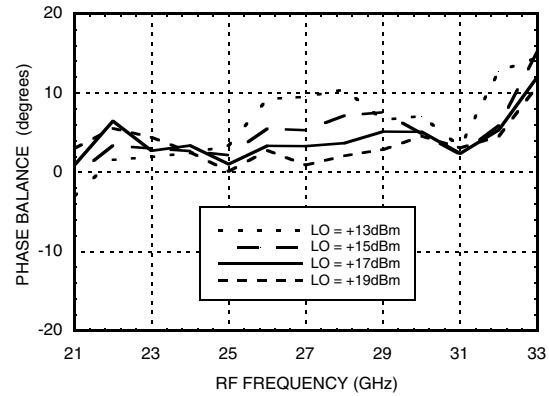

**Upconverter Performance
Conversion Gain vs. LO Drive**

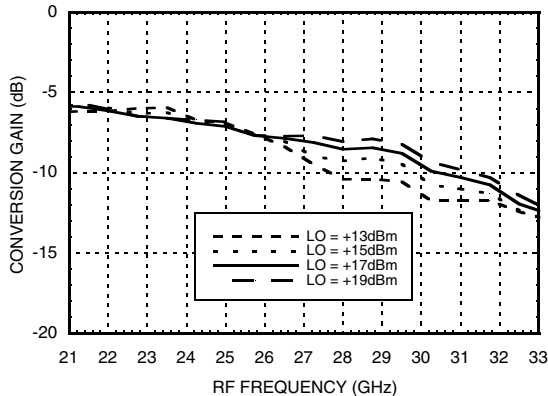

**Upconverter Performance
Sideband Rejection vs. LO Drive**

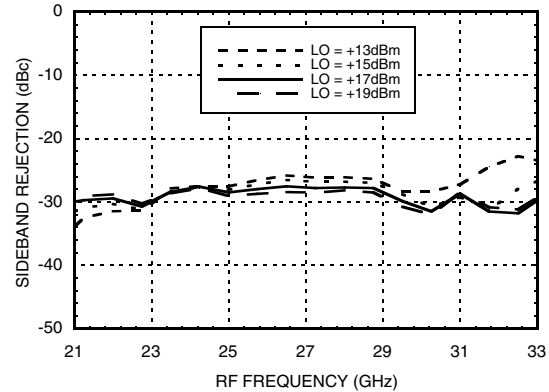

Information furnished by Analog Devices is believed to be accurate and reliable. However, no responsibility is assumed by Analog Devices for its use, nor for any infringements of patents or other rights of third parties that may result from its use. Specifications subject to change without notice. No license is granted by implication or otherwise under any patent or patent rights of Analog Devices. Trademarks and registered trademarks are the property of their respective owners.

For price, delivery, and to place orders: Analog Devices, Inc., One Technology Way, P.O. Box 9106, Norwood, MA 02062-9106 Phone: 781-329-4700 • Order online at www.analog.com Application Support: Phone: 1-800-ANALOG-D

MIXERS - I/Q MIXERS, IRMS & RECEIVERS - SMT



GaAs MMIC I/Q MIXER 22 - 32 GHz

Absolute Maximum Ratings

RF / IF Input	+20 dBm
LO Drive	+27 dBm
Channel Temperature	150°C
Continuous Pdiss (T=85°C) (derate 9.8 mW/°C above 85°C)	340 mW
Thermal Resistance (R _{TH}) (junction to die bottom)	191.5 °C/W
Storage Temperature	-65 to +150 °C
Operating Temperature	-55 to +85 °C
ESD Sensitivity (HBM)	Class 1A

MxN Spurious Outputs

mRF	nLO				
	0	1	2	3	4
0	xx	-13	27	xx	xx
1	18	0	35	52	xx
2	76	74	87	74	82
3	xx	83	87	77	87
4	xx	xx	82	87	87

RF = 24.5 GHz @ -10 dBm
LO = 24.4 GHz @ 17 dBm
Data taken without IF hybrid
All values in dBc below IF power level



ELECTROSTATIC SENSITIVE DEVICE
OBSERVE HANDLING PRECAUTIONS

Outline Drawing

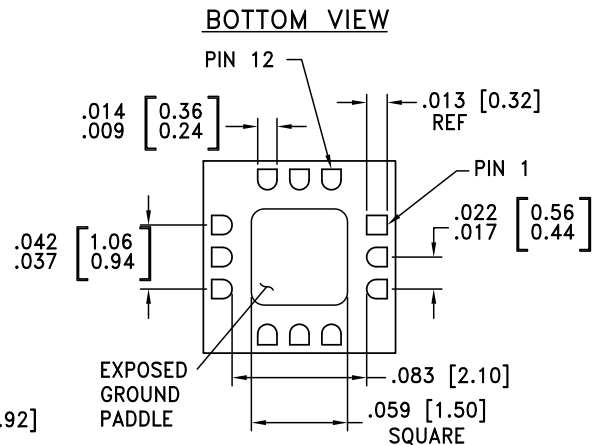
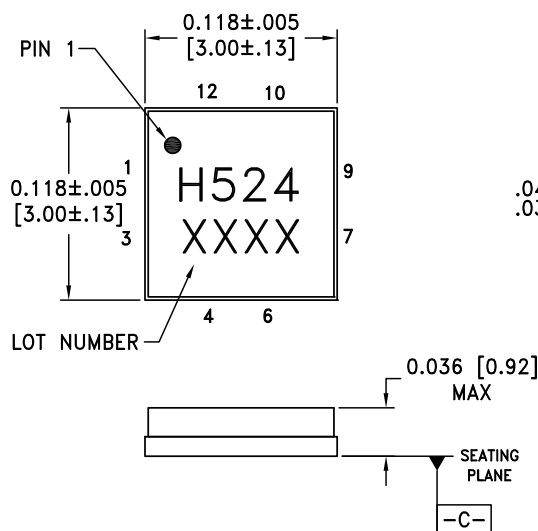

- NOTES:
- PACKAGE BODY MATERIAL: ALUMINA
 - LEAD AND GROUND PADDLE PLATING: 30 - 80 MICROINCHES GOLD OVER 50 MICROINCHES MINIMUM NICKLE
 - DIMENSIONS ARE IN INCHES [MILLIMETERS]
 - LEAD SPACING TOLERANCE IS NON-CUMULATIVE
 - PACKAGE WARP SHALL NOT EXCEED 0.05mm DATUM
 - ALL GROUND LEADS AND GROUND PADDLE MUST BE SOLDERED TO PCB RF GROUND

Package Information

Part Number	Package Body Material	Lead Finish	MSL Rating	Package Marking ^[2]
HMC524LC3B	Alumina, White	Gold over Nickel	MSL3 ^[1]	H524 XXXX

[1] Max peak reflow temperature of 260 °C
[2] 4-Digit lot number XXXX

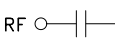
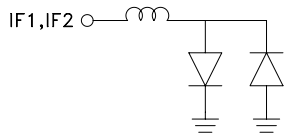
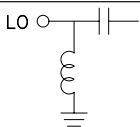

Pin Descriptions

Pin Number	Function	Description	Interface Schematic
1, 3, 7, 8, 10, 11, 12	GND	The backside of the die must be connected to RF/DC ground.	
2	RF	This pad is AC coupled and matched to 50 Ohms.	
4	IF1	This pad is DC coupled. For applications not requiring operation to DC, this port should be DC blocked externally using a series capacitor whose value has been chosen to pass the necessary IF frequency range. For operation to DC, this pad must not source/sink more than 3mA of current or die non-function and possible die failure will result.	
6	IF2		
5	N/C	No connection required. These pins may be connected to RF/DC ground without affecting performance	
9	LO	This pad is DC coupled and matched to 50 Ohms.	



Evaluation PCB

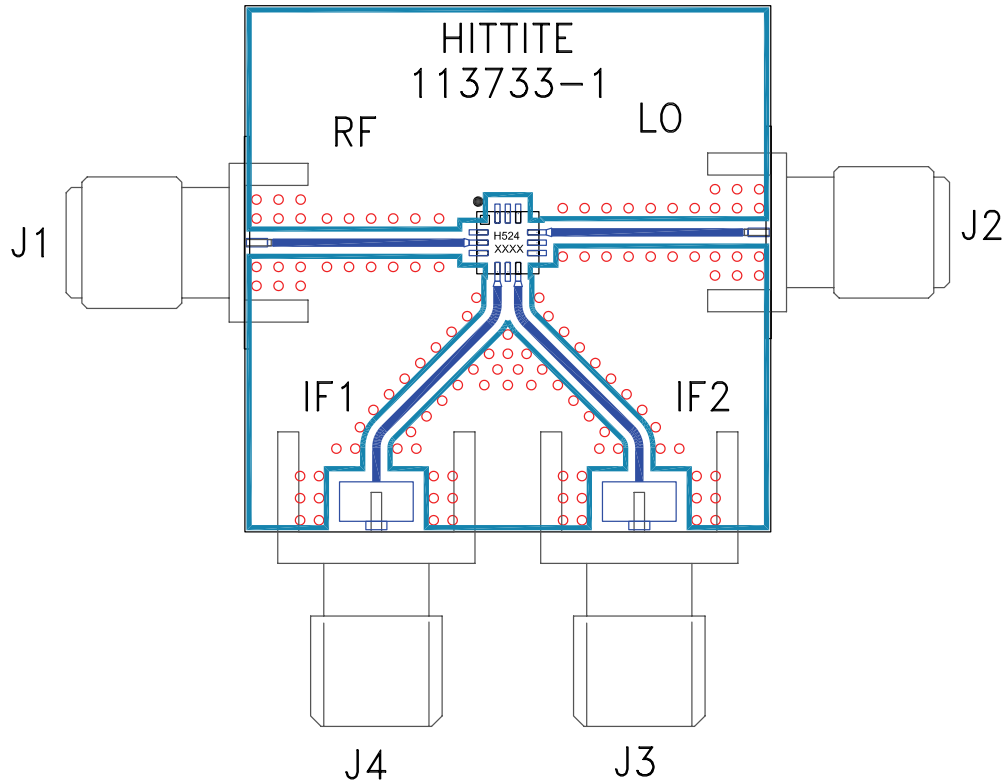

List of Materials for Evaluation PCB 109998 [1]

Item	Description
J1, J2	PCB Mount K RF Connector, SRI
J3 - J4	PCB Mount SMA Connector, Johnson
U1	HMC524LC3B Mixer
PCB [2]	109996 Evaluation Board

[1] Reference this number when ordering complete evaluation PCB

[2] Circuit Board Material: Rogers 4350

The circuit board used in the application should use RF circuit design techniques. Signal lines should have 50 Ohm impedance while the package ground leads and exposed paddle should be connected directly to the ground plane similar to that shown. A sufficient number of via holes should be used to connect the top and bottom ground planes. The evaluation circuit board shown is available from Hitrite upon request.

Looking for pricing, stock, or lifecycle information?

Click below to explore more details on WIN SOURCE:

-  [View HMC524LC3BTR on WIN SOURCE](#)
-  [Analog Devices Inc. Information](#)

Optimize Your Supply Chain with WIN SOURCE Solutions

-  Global Sourcing Solution
-  Obsolete Management
-  Cost Control Management
-  Shortage Management
-  Alternative Solution
-  Excess Inventory Management