

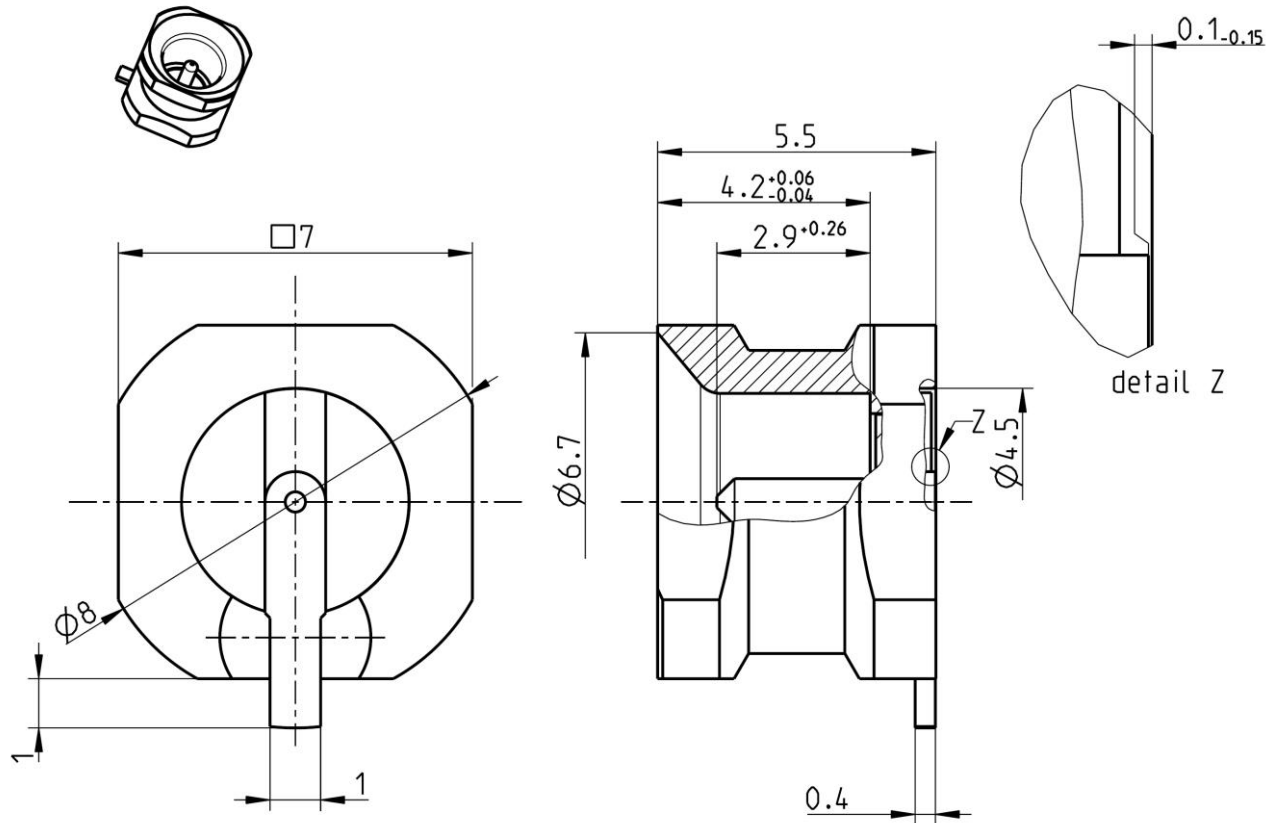

**THE DATASHEET OF  
119S144-40ML5**





All dimensions are in mm; tolerances according to ISO 2768 m-H

**Interface**

According to

Rosenberger P-SMP

**Documents**

Panel piercing  
Tape & reel packaging

B 120b  
VG163-01M00

**Material and plating**

**Connector parts**

Center contact  
Outer contact  
Dielectric

**Material**

Brass  
Brass  
PEEK

**Plating**

AuroDur®, gold plated  
AuroDur®, gold plated

**Electrical data**

Impedance	50 Ω
Frequency	DC to 10 GHz
Return loss	≥ 30 dB, DC to 4 GHz ≥ 25 dB, 4 to 6 GHz
Insertion loss	≤ 0.03 x √f(GHz) dB
Insulation resistance	≥ 5 GΩ
Center contact resistance	≤ 3.0 mΩ
Outer contact resistance	≤ 2.0 mΩ
Test voltage (at sea level)	1000 V rms
Working voltage (at sea level)	480 V rms
Power handling (at 20 °C, sea level)	≤ 200 W @ 2.2 GHz
Intermodulation (3 <sup>rd</sup> order)	≥ 160 dBc (2 x 43 dBm)

- Connector only, VSWR in application depends decisive on PCB layout

**Mechanical data**

Mating cycles	≥ 1000
Center contact captivation	≥ 7 N
Engagement force	10 N max.
Disengagement force	2.2 N min.

**Environmental data**

Temperature range	-65°C to +165°C
Rapid change of temperature	IEC 60169-1, Sub-clause 16.4 (-65°C to +165°C)
Vibration	IEC 60068-2-64 random
Shock	IEC 60068-2-27 (half-sine)
High temperature endurance	IEC 60169-1, Sub-clause 18 (+165°C, 1000 hours)
Max. soldering temperature	IEC 61760-1, +260°C for 10 sec.
RoHS	compliant

**Tooling**

N/A

**Suitable cables**

N/A

**Weight**

Weight	1.01 g/pce
--------	------------

While the information has been carefully compiled to the best of our knowledge, nothing is intended as representation or warranty on our part and no statement herein shall be construed as recommendation to infringe existing patents. In the effort to improve our products, we reserve the right to make changes judged to be necessary.



For the installation of the electrotechnical equipment, particular electrotechnical expertise is required.







Draft	Date	Approved	Date	Rev.	Engineering change number	Name	Date
Huppenberger	19.10.20	Chr. Janßen	19.10.20	k00	20-1927	S. Huber-Siegl	19.10.20

## Looking for pricing, stock, or lifecycle information?

Click below to explore more details on WIN SOURCE:

-  [View 119S144-40ML5 on WIN SOURCE](#)
-  [Rosenberger Information](#)

## Optimize Your Supply Chain with WIN SOURCE Solutions

-  Global Sourcing Solution
-  Obsolete Management
-  Cost Control Management
-  Shortage Management
-  Alternative Solution
-  Excess Inventory Management