



**THE DATASHEET OF  
CP0805B2442AWTR**



# Thin-Film Directional Couplers



## CP0805 SMD Type

### GENERAL DESCRIPTION ITF (Integrated Thin-Film) TECHNOLOGY

The ITF SMD Coupler is based on thin-film multilayer technology. The technology provides a miniature part with excellent high frequency performance and rugged construction for reliable automatic assembly.

The ITF Coupler is offered in a variety of frequency bands compatible with various types of high frequency wireless systems.

### FEATURES

- Small Size: 0805
- Frequency Range: 800MHz - 3GHz
- Characteristic Impedance: 50Ω
- Operating / Storage Temp.: -40°C to +85°C
- Power Rating: 3W Continuous
- Low Profile
- Rugged Construction
- Taped and Reeled

### APPLICATIONS

- Mobile Communications
- Satellite TV Receivers
- GPS
- Vehicle Location Systems
- Wireless LAN's

### DIMENSIONS: (Top View) millimeters (inches)

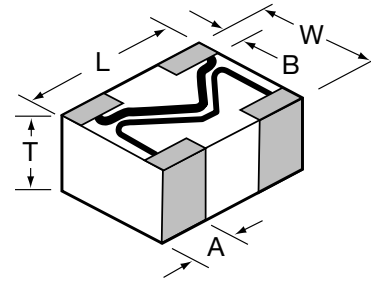

| 0805 |                         |
|------|-------------------------|
| L    | 2.03±0.1 (0.080±0.004)  |
| W    | 1.55±0.1 (0.061±0.004)  |
| T    | 0.98±0.1 (0.039±0.004)  |
| A    | 0.56±0.25 (0.022±0.010) |
| B    | 0.35±0.15 (0.014±0.006) |

### HOW TO ORDER

|                                                       |                                         |                                                           |                                             |                                                            |                                                                                                                  |                                                               |
|-------------------------------------------------------|-----------------------------------------|-----------------------------------------------------------|---------------------------------------------|------------------------------------------------------------|------------------------------------------------------------------------------------------------------------------|---------------------------------------------------------------|
| <b>CP</b><br>↓<br><b>Style</b><br>Directional Coupler | <b>0805</b><br>↓<br><b>Size</b><br>0805 | <b>A</b><br>↓<br><b>Layout Type</b><br>(see layout types) | <b>0902</b><br>↓<br><b>Frequency</b><br>MHz | <b>A</b><br>↓<br><b>Sub Type</b><br>(see layout sub-types) | <b>S</b><br>↓<br><b>Termination Code</b><br>W = Nickel/Solder (Sn/Pb)<br>**S = Nickel / Lead Free Solder (Sn100) | <b>TR</b><br>↓<br><b>Packaging Code</b><br>TR = Tape and Reel |
|-------------------------------------------------------|-----------------------------------------|-----------------------------------------------------------|---------------------------------------------|------------------------------------------------------------|------------------------------------------------------------------------------------------------------------------|---------------------------------------------------------------|

Not RoHS Compliant



LEAD-FREE  
LEAD-FREE COMPATIBLE  
COMPONENT



RoHS  
COMPLIANT

For RoHS compliant products, please select correct termination style.

\*\*RoHS compliant

### QUALITY INSPECTION

Finished parts are 100% tested for electrical parameters and visual characteristics. Each production lot is evaluated on a sample basis for:

- Static Humidity: 85°C, 85% RH, 160 hours
- Endurance: 125°C, I<sub>R</sub>, 4 hours

### TERMINATION

Nickel/Solder coating (Sn, Pb) compatible with automatic soldering technologies: reflow, wave soldering, vapor phase and manual.

### Recommended Pad Layout Dimensions mm (inches)

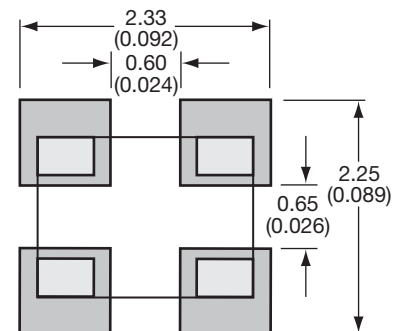

NOTE: Components must be mounted on the board with the white (Alumina) side DOWN.

# Thin-Film Directional Couplers



## CP0805 Layout Types

### LAYOUT

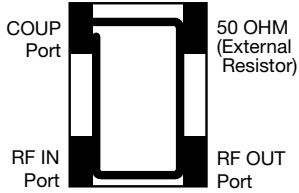

### Sn100 LAYOUT

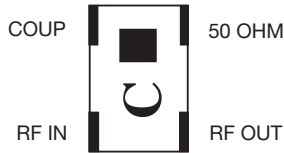

Type: A  
Sub-Type: A

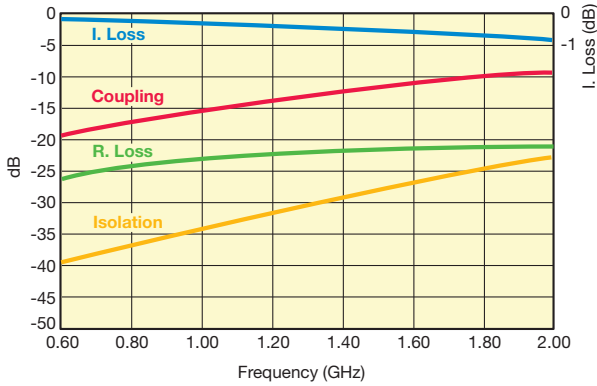

### LAYOUT

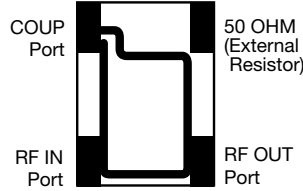

### Sn100 LAYOUT

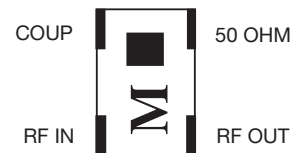

Type: A  
Sub-Type: B

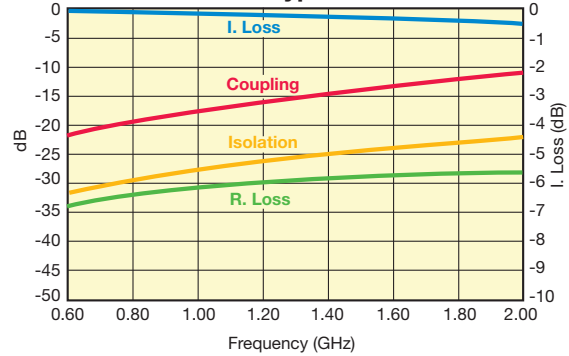

| Application | P/N Examples  | Frequency Band [MHz] | Coupling [dB] | I. Loss max | VSWR max |
|-------------|---------------|----------------------|---------------|-------------|----------|
| AMPS        | CP0805A0836AW | 824 - 849            | 16.5±1        | 0.25        | 1.2      |
|             | CP0805A0881AW | 869 - 894            | 16±1          |             |          |
| GSM         | CP0805A0902AW | 890 - 915            | 16±1          |             |          |
|             | CP0805A0947AW | 935 - 960            | 15.5±1        |             |          |
| E-GSM       | CP0805A0897AW | 880 - 915            | 16±1          |             |          |
|             | CP0805A0942AW | 925 - 960            | 15.5±1        |             |          |
| PDC         | CP0805A1441AW | 1429 - 1453          | 12±1          | 0.5         | 1.3      |
| PCN         | CP0805A1747AW | 1710 - 1785          | 10.5±1        | 0.8         | 1.4      |
|             | CP0805A1842AW | 1805 - 1880          | 10±1          |             |          |
| PCS         | CP0805A1880AW | 1850 - 1910          | 9.5±1         | 0.7         | 1.4      |
|             | CP0805A1960AW | 1930 - 1990          | 9.5±1         |             |          |
| PHP         | CP0805A1907AW | 1895 - 1920          | 9.5±1         | 0.6         |          |
| DECT        | CP0805A1890AW | 1880 - 1900          | 9.5±1         | 0.6         |          |

| Application  | P/N Examples  | Frequency Band [MHz] | Coupling [dB] | I. Loss max | VSWR max |
|--------------|---------------|----------------------|---------------|-------------|----------|
| AMPS         | CP0805A0836BW | 824 - 849            | 19±1          | 0.25        | 1.2      |
|              | CP0805A0881BW | 869 - 894            | 18.5±1        |             |          |
| GSM          | CP0805A0902BW | 890 - 915            | 18±1          |             |          |
|              | CP0805A0947BW | 935 - 960            | 18±1          |             |          |
| E-GSM        | CP0805A0897BW | 880 - 915            | 18.5±1        |             |          |
|              | CP0805A0942BW | 925 - 960            | 18±1          |             |          |
| PDC          | CP0805A1441BW | 1429 - 1453          | 14.5±1        | 0.35        |          |
| PCN          | CP0805A1747BW | 1710 - 1785          | 12.5±1        | 0.5         | 1.4      |
|              | CP0805A1842BW | 1805 - 1880          | 12.5±1        |             |          |
| PCS          | CP0805A1880BW | 1850 - 1910          | 12±1          | 0.7         | 1.4      |
|              | CP0805A1960BW | 1930 - 1990          | 11.5±1        |             |          |
| PHP          | CP0805A1907BW | 1895 - 1920          | 12±1          | 0.6         |          |
| DECT         | CP0805A1890BW | 1880 - 1900          | 12±1          | 0.6         |          |
| Wireless LAN | CP0805A2442BW | 2400 - 2484          | 10±1          | 0.9         |          |

### LAYOUT

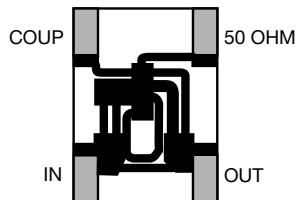

### Sn100 LAYOUT

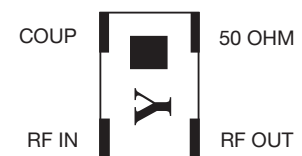

Type: A  
Sub-Type: C

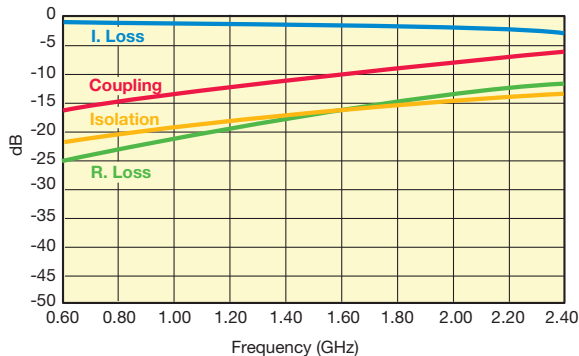

| Application  | P/N Examples  | Frequency Band [MHz] | Coupling [dB] | I. Loss max | VSWR max |
|--------------|---------------|----------------------|---------------|-------------|----------|
| AMPS         | CP0805A0836CW | 824 - 849            | 14±1          | 0.5         | 1.4      |
|              | CP0805A0881CW | 869 - 894            | 13.5±1        |             |          |
| GSM          | CP0805A0902CW | 890 - 915            | 13.5±1        |             |          |
|              | CP0805A0947CW | 935 - 960            | 13±1          |             |          |
| E-GSM        | CP0805A0897CW | 880 - 915            | 13.5±1        |             |          |
|              | CP0805A0942CW | 925 - 960            | 13±1          |             |          |
| PDC          | CP0805A1441CW | 1429 - 1453          | 9.5±1         | 1.15        | 1.8      |
| PCN          | CP0805A1747CW | 1710 - 1785          | 8±1           | 1.6         | 2.2      |
|              | CP0805A1842CW | 1805 - 1880          | 8±1           |             |          |
| PCS          | CP0805A1880CW | 1850 - 1910          | 7.5±1         | 1.75        | 2.2      |
|              | CP0805A1960CW | 1930 - 1990          | 7.5±1         |             |          |
| PHP          | CP0805A1907CW | 1895 - 1920          | 7.5±1         | 2.5         |          |
| DECT         | CP0805A1890CW | 1880 - 1900          | 7.5±1         | 2.5         |          |
| Wireless LAN | CP0805A2442CW | 2400 - 2484          | 6±1           | 2.5         |          |

Important: Couplers can be used at any frequency within the indicated range.



# Thin-Film Directional Couplers



## CP0805 Layout Types

### LAYOUT

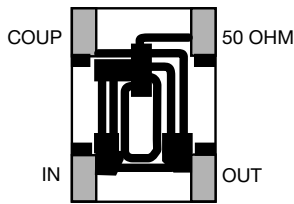

### Sn100 LAYOUT

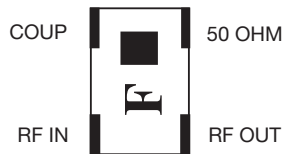

Type: A  
Sub-Type: D

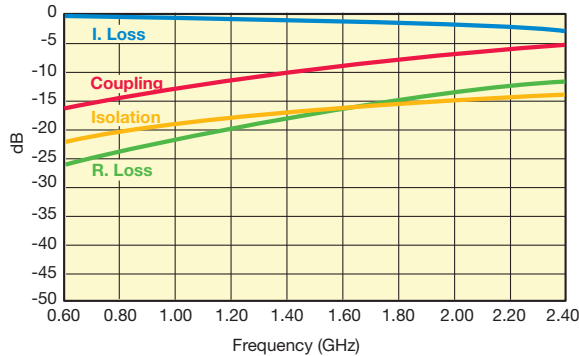

| Application  | P/N Examples  | Frequency Band [MHz] | Coupling [dB] | I. Loss max | VSWR max |
|--------------|---------------|----------------------|---------------|-------------|----------|
| AMPS         | CP0805A0836DW | 824 - 849            | 13.0±1        | 0.5         | 1.4      |
|              | CP0805A0881DW | 869 - 894            | 12.5±1        |             |          |
| GSM          | CP0805A0902DW | 890 - 915            | 12.5±1        | 1.85        | 1.8      |
|              | CP0805A0947DW | 935 - 960            | 12±1          |             |          |
| E-GSM        | CP0805A0897DW | 880 - 915            | 12.5±1        | 2.15        | 2.1      |
|              | CP0805A0942DW | 925 - 960            | 12±1          |             |          |
| PDC          | CP0805A1441DW | 1429 - 1453          | 8.5±1         | 1.25        | 1.8      |
| PCN          | CP0805A1747DW | 1710 - 1785          | 7±1           | 1.85        | 2.2      |
|              | CP0805A1842DW | 1805 - 1880          | 7±1           |             |          |
| PCS          | CP0805A1880DW | 1850 - 1910          | 7±1           | 2.4         | 2.1      |
|              | Cp0805A1960DW | 1930 - 1990          | 6.5±1         |             |          |
| PHP          | CP0805A1907DW | 1895 - 1920          | 6.5±1         | 1.85        | 1.8      |
| DECT         | CP0805A1890DW | 1880 - 1900          | 7±1           | 1.85        | 1.8      |
| Wireless LAN | CP0805A2442DW | 2400 - 2484          | 5.5±1         | 2.4         | 2.1      |

### LAYOUT

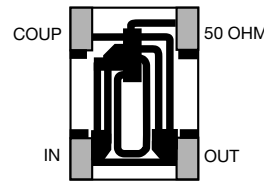

### Sn100 LAYOUT



Type: A  
Sub-Type: E

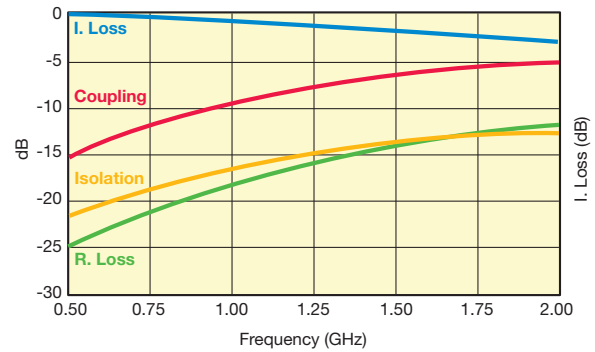

| Application  | P/N Examples  | Frequency Band [MHz] | Coupling [dB] | I. Loss max | VSWR max |
|--------------|---------------|----------------------|---------------|-------------|----------|
| AMPS         | CP0805A0836EW | 824 - 849            | 11±1          | 0.85        | 1.4      |
|              | CP0805A0881EW | 869 - 894            | 10.5±1        |             |          |
| GSM          | CP0805A0902EW | 890 - 915            | 10.5±1        | 1.8         | 1.8      |
|              | CP0805A0947EW | 935 - 960            | 10±1          |             |          |
| E-GSM        | CP0805A0897EW | 880 - 915            | 10.5±1        | 2.7         | 2.2      |
|              | CP0805A0942EW | 925 - 960            | 10±1          |             |          |
| PDC          | CP0805A1441EW | 1429 - 1453          | 7±1           | 1.8         | 1.8      |
| PCN          | CP0805A1747EW | 1710 - 1785          | 5.5±1         | 3.15        | 2.4      |
|              | CP0805A1842EW | 1805 - 1880          | 5.5±1         |             |          |
| PCS          | CP0805A1880EW | 1850 - 1910          | 5±1           | 4.2         | 2.4      |
|              | Cp0805A1960EW | 1930 - 1990          | 5±1           |             |          |
| PHP          | CP0805A1907EW | 1895 - 1920          | 5±1           | 1.85        | 1.8      |
| DECT         | CP0805A1890EW | 1880 - 1900          | 5±1           | 1.85        | 1.8      |
| Wireless LAN | CP0805A2442EW | 2400 - 2484          | 4±1           | 2.4         | 2.1      |

Type: B  
Sub-Type: A

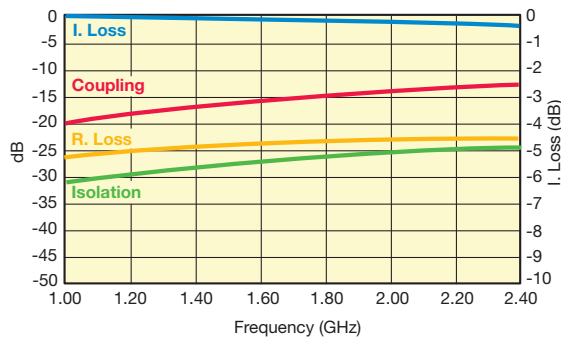

### LAYOUT

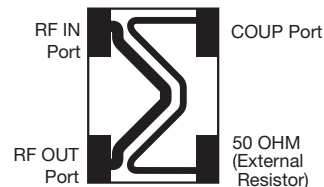

### Sn100 LAYOUT

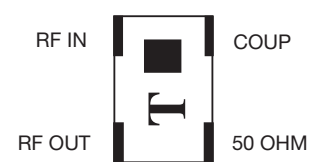

| Application  | P/N Examples  | Frequency Band [MHz] | Coupling [dB] | I. Loss max | VSWR max |
|--------------|---------------|----------------------|---------------|-------------|----------|
| AMPS         | CP0805B0836AW | 824 - 849            | 21.5±1        | 0.25        | 1.2      |
|              | CP0805B0881AW | 869 - 894            | 21±1          |             |          |
| GSM          | CP0805B0902AW | 890 - 915            | 21±1          | 0.3         | 1.2      |
|              | CP0805B0947AW | 935 - 960            | 20.5±1        |             |          |
| E-GSM        | CP0805B0897AW | 880 - 915            | 21±1          | 0.4         | 1.2      |
|              | CP0805B0942AW | 925 - 960            | 20.5±1        |             |          |
| PDC          | CP0805B1441AW | 1429 - 1453          | 17±1          | 0.3         | 1.2      |
| PCN          | CP0805B1747AW | 1710 - 1785          | 15.5±1        | 0.3         | 1.2      |
|              | Cp0805B1842AW | 1805 - 1880          | 15.5±1        |             |          |
| PCS          | CP0805B1880AW | 1850 - 1910          | 15±1          | 0.4         | 1.2      |
|              | CP0805B1960AW | 1930 - 1990          | 14.5±1        |             |          |
| PHP          | CP0805B1907AW | 1895 - 1920          | 15±1          | 0.3         | 1.2      |
| DECT         | CP0805B1890AW | 1880 - 1900          | 15±1          | 0.3         | 1.2      |
| Wireless LAN | CP0805B2442AW | 2400 - 2484          | 13±1          | 0.4         | 1.2      |

Important: Couplers can be used at any frequency within the indicated range.

# Thin-Film Directional Couplers



## CP0805 Layout Types

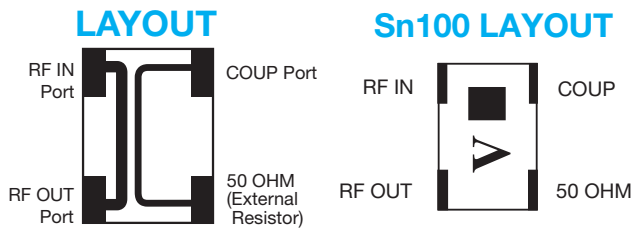

Type: B  
Sub-Type: B

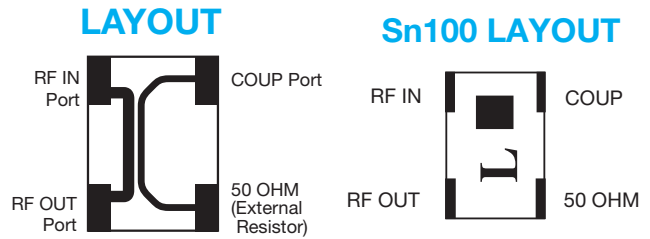
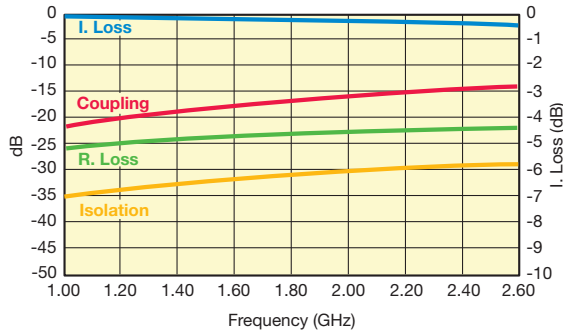

Type: B  
Sub-Type: C

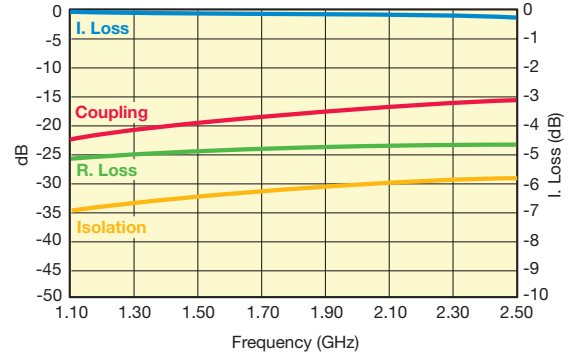

| Application  | P/N Examples  | Frequency Band [MHz] | Coupling [dB] | I. Loss max | VSWR max |
|--------------|---------------|----------------------|---------------|-------------|----------|
| AMPS         | CP0805B0836BW | 824 - 849            | 23.5±1        | 0.25        | 1.2      |
|              | CP0805B0881BW | 869 - 894            | 23±1          |             |          |
| GSM          | CP0805B0902BW | 890 - 915            | 22.5±1        |             |          |
|              | CP0805B0947BW | 935 - 960            | 22±1          |             |          |
| E-GSM        | CP0805B0897BW | 880 - 915            | 23±1          |             |          |
|              | CP0805B0942BW | 925 - 960            | 22±1          |             |          |
| PDC          | CP0805B1441BW | 1429 - 1453          | 18.5±1        |             |          |
| PCN          | CP0805B1747BW | 1710 - 1785          | 17±1          |             |          |
|              | CP0805B1842BW | 1805 - 1880          | 16.5±1        |             |          |
| PCS          | CP0805B1880BW | 1850 - 1910          | 16.5±1        |             |          |
|              | CP0805B1960BW | 1930 - 1990          | 16±1          |             |          |
| PHP          | CP0805B1907BW | 1895 - 1920          | 16±1          |             |          |
| DECT         | CP0805B1890BW | 1880 - 1900          | 16±1          |             |          |
| Wireless LAN | CP0805B2442BW | 2400 - 2484          | 14±1          | 0.4         |          |

| Application  | P/N Examples  | Frequency Band [MHz] | Coupling [dB] | I. Loss max | VSWR max |
|--------------|---------------|----------------------|---------------|-------------|----------|
| AMPS         | CP0805B0836CW | 824 - 849            | 25±1          | 0.25        | 1.2      |
|              | CP0805B0881CW | 869 - 894            | 24.5±1        |             |          |
| GSM          | CP0805B0902CW | 890 - 915            | 24±1          |             |          |
|              | CP0805B0947CW | 935 - 960            | 24±1          |             |          |
| E-GSM        | CP0805B0897CW | 880 - 915            | 24.5±1        |             |          |
|              | CP0805B0942CW | 925 - 960            | 24±1          |             |          |
| PDC          | CP0805B1441CW | 1429 - 1453          | 20±1          |             |          |
| PCN          | CP0805B1747CW | 1710 - 1785          | 18.5±1        |             |          |
|              | CP0805B1842CW | 1805 - 1880          | 18.5±1        |             |          |
| PCS          | CP0805B1880CW | 1850 - 1910          | 18±1          |             |          |
|              | CP0805B1960CW | 1930 - 1990          | 17.5±1        |             |          |
| PHP          | CP0805B1907CW | 1895 - 1920          | 18±1          |             |          |
| DECT         | CP0805B1890CW | 1880 - 1900          | 18±1          |             |          |
| Wireless LAN | CP0805B2442CW | 2400 - 2484          | 16±1          | 0.4         |          |

Important: Couplers can be used at any frequency within the indicated range.



# Thin-Film Directional Couplers



## CP0805 Layout Types

### VHF DIRECTIONAL COUPLER

CP0805L0155ASTR

Sn100 LAYOUT

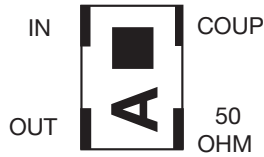

| P/N             | Frequency [MHz] | Coupling [dB] | R. Loss [dB] | I. Loss max [dB] | Directivity [dB] |
|-----------------|-----------------|---------------|--------------|------------------|------------------|
| CP0805L0155ASTR | 155             | 17.1±1        | 24           | 0.35             | 22               |

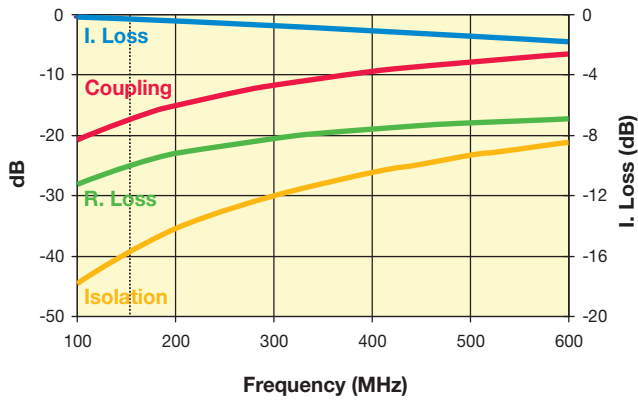

### UHF DIRECTIONAL COUPLER

CP0805L0436BSTR

Sn100 LAYOUT

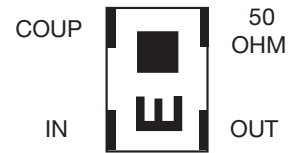

| P/N             | Frequency [MHz] | Coupling [dB] | R. Loss [dB] | I. Loss max [dB] | Directivity [dB] |
|-----------------|-----------------|---------------|--------------|------------------|------------------|
| CP0805L0436BSTR | 403-470         | 15.85±1       | 35           | 0.25             | 22               |

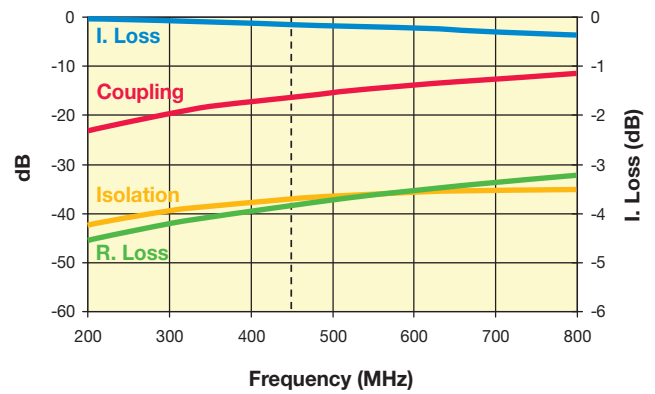

Important: Couplers can be used at any frequency within the indicated range.

# Thin-Film Directional Couplers



## CP0805 and CP0603 Test Jig

### ITF TEST JIG FOR COUPLER TYPES 0805 AND 0603 SMD

#### GENERAL DESCRIPTION

This jig is designed for the testing of CP0805 and CP0603 series Directional Couplers using a vector network analyzer. It consists of a FR4 multi-layer substrate, having 50Ω microstrips as conducting lines and a ground plane in the middle layer, located at a distance of 0.2mm from the microstrips.

The connectors are SMA type (female), 'Johnson Components Inc.' Product P/N: 142-0701-881.

The jig is designed for a full 2-port calibration. LOAD calibration can be done either by a 50Ω SMA termination, or by soldering a 50Ω chip resistor at the 50Ω ports.

#### MEASUREMENT PROCEDURE

When measuring a component, it can be either soldered or pressed by a non-metallic stick until all four ports touch the appropriate pads. To measure the coupling (and the R. Loss) place the component on the Port 1 & Port 2 pads. Use two SMA 50Ω terminations (male) to terminate the ports, which are not connected to the network analyzer, and connect the network analyzer to the two ports. A 90° rotation of the component on its pads allows measuring a second parameter (I. Loss).

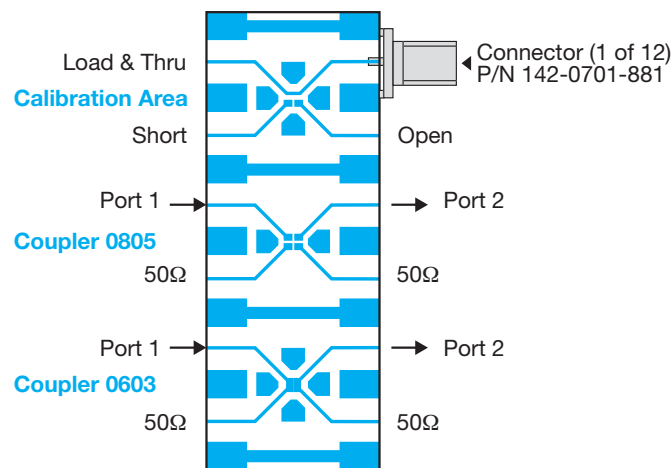

### CP0805 SERIES DIRECTIONAL COUPLERS

#### Orientation and Tape and Reel Packaging Specification

(Top View)

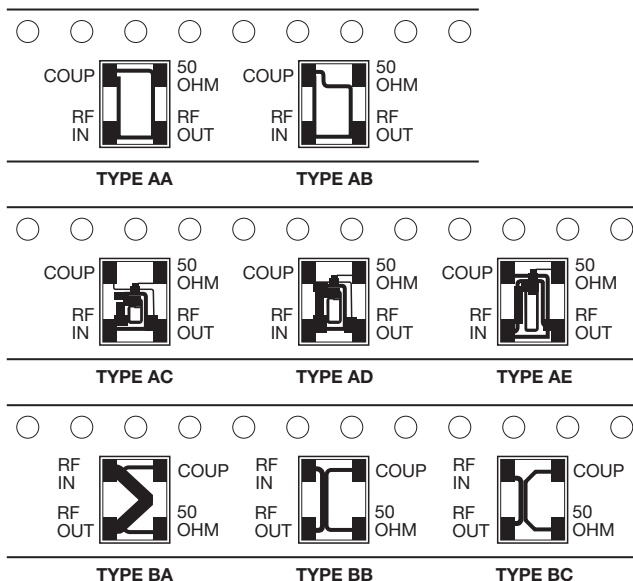

The parts should be mounted on the PCB with White (Alumina) side down and the "dark" side up.

#### CP0805xxxxxxSTR (Sn100)

(Top View)

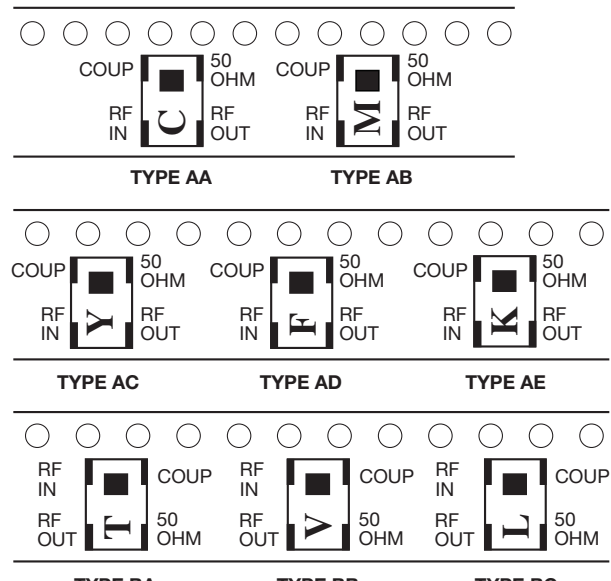

The parts should be mounted on the PCB with printed side up.



## Looking for pricing, stock, or lifecycle information?

Click below to explore more details on WIN SOURCE:

 [View CP0805B2442AWTR on WIN SOURCE](#)

 [AVX Corporation](#) Information

## Optimize Your Supply Chain with WIN SOURCE Solutions

-  Global Sourcing Solution
-  Obsolete Management
-  Cost Control Management
-  Shortage Management
-  Alternative Solution
-  Excess Inventory Management