



**THE DATASHEET OF
LTPL-M04520QS30-T0**



LIGHT LED M04 CoB Product Series

1. Description

The LiteON CoB Product series is a revolutionary, energy efficient and ultra-compact new light source, combining the lifetime and reliability advantages of Light Emitting Diodes with the brightness of conventional lighting. It gives you total design freedom and unmatched brightness, creating a new opportunities for solid state lighting to displace conventional lighting technologies.

1.1 Features

- Compact high flux density light source
- Uniform high quality illumination
- Streamlined thermal path
- MacAdam compliant binning structure
More energy efficient than incandescent, halogen and fluorescent lamps
- Instant light with unlimited dimming
- RoHS compliant and Pb free

1.2 Benefits Features

- Enhanced optical control
- Clean white light without pixilation
- Uniform consistent white light
- Significantly reduced thermal resistance and increased operating temperatures
- Lower operating costs
- Reduced maintenance costs
- ESD rating is 8KV in HBM

1.3 Naming Rule

L	T	PL	-	M	0	4	5	X	X	Z	S	X	X	-	X	X
		Code1			Code2		Code3	Code4		Code5		Code6			Code7	

Code 1: Product Line

PL: High Power LED

Code 2: Package Type/Platform

M04: Metal substrate with 19x19mm square

Code 3: Light Emitting Surface

5: 14.5mm excluding dam

Code 4: Product Series

20: 20 Series

30: 30 Series

Code 5: CRI

Z: White Color Rendering Index 80 min.

Q: White Color Rendering Index 90 min.

Code 6: Color Temperature

30: 3000K at 85degC

40: 4000K at 85degC

50: 5000K at 85degC

Note: The Color Temperature follow ANSI C78.377A Doc

Code 7: Hue Bin by MacAdam Ellipses Step

T0: 3000K~4000K MacAdam Ellipse / ANSI Bin

F1: 5000K MacAdam Ellipse / ANSI Bin

LIGHT LED M04 CoB Product Series

1.4 Product List

Part Number	Product Series	VF Type	CCT	CRI	Color Bin			Lumen Bin	
					3SDCM	5SDCM	ANSI	-8%~+8%	-15%~+15%
LTPL-M04520ZS30-T0	20	37V	3000K	80	☆	☆	☆	☆	☆
LTPL-M04520QS30-T0	20	37V	3000K	90	☆	☆	☆	☆	☆
LTPL-M04520ZS40-T0	20	37V	4000K	80	☆	☆	☆	☆	☆
LTPL-M04520ZS50-F1	20	37V	5000K	80	-	☆	☆	☆	☆
LTPL-M04530ZS30-T0	30	37V	3000K	80	☆	☆	☆	☆	☆
LTPL-M04530QS30-T0	30	37V	3000K	90	☆	☆	☆	☆	☆
LTPL-M04530ZS40-T0	30	37V	4000K	80	☆	☆	☆	☆	☆
LTPL-M04530ZS50-F1	30	37V	5000K	80	-	☆	☆	☆	☆

LIGHT LED M04 CoB Product Series

2. Outline Dimensions

2.1 Form Factor of M04 series CoB

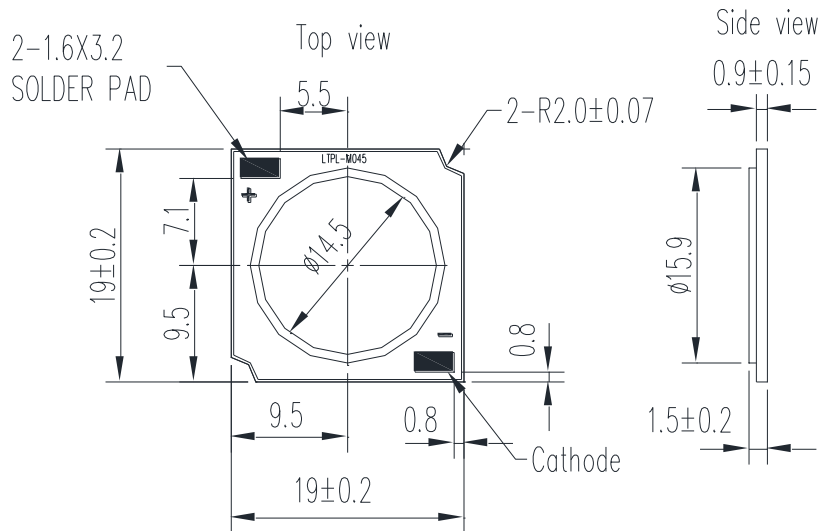

Notes

1. All dimensions are in millimeters.
2. Tolerance is ± 0.3 mm unless otherwise noted.

2.2 Internal Equivalent Circuit

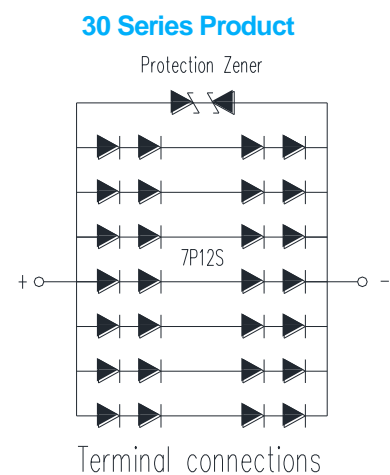
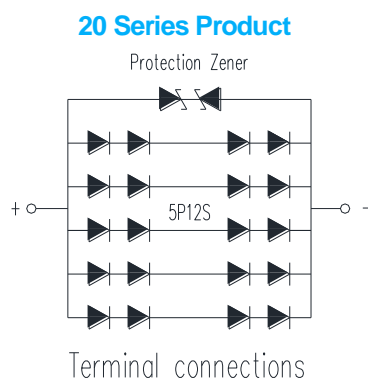

Notes

1. LED of equivalent circuit means all series/parallel in CoB package.

LIGHT LED M04 CoB Product Series

3. Absolute Maximum Ratings at Ta=25°C

Parameter	Symbol	Product Series	Rating	Unit
Power Dissipation	P _O	20	39.4	W
		30	55.2	
Forward Current	I _F	20	1000	mA
		30	1400	
Thermal Resistance, Junction-Case	R _{th, J-C}	20	0.44	°C/W
		30	0.37	
Junction Temperature	T _j		125	°C
Operating Temperature Range	T _{opr}		-40 to 85	°C
Storage Temperature Range	T _{stg}		-40 to 100	°C
Electrostatic Discharge	ESD		8	KV

Notes

1. The pulse mode condition is 1/10 duty cycle with 100 msec pulse width.
2. Forbid to be operated at reverse voltage condition.
3. ESD spec is reference to AEC-Q101-001 HBM.
4. The unit of R_{th} is °C/W electrical.
5. The CoB is recommended soldering temperature under 350degC and could not over 3.5sec.

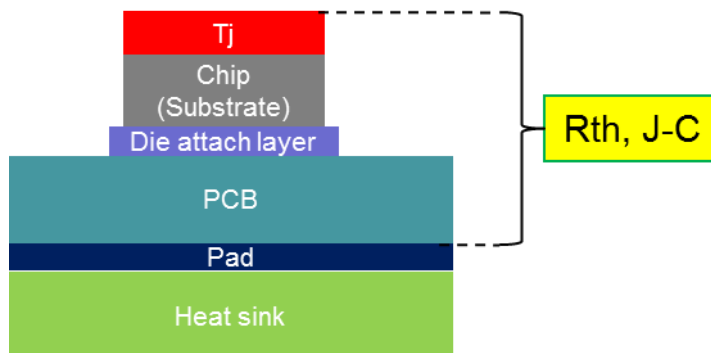

LIGHT LED M04 CoB Product Series

4. Electro-Optical Characteristics

4.1 Typical Performance

Dominant CCT	Watt	CRI	Current (mA)	V _F (V) @25°C	Flux(lm) @25°C	V _F (V) @85°C	Flux(lm) @85°C	Eff.(lm/W) @25°C	Eff.(lm/W) @85°C
3000K	20	80	480	36.2	2696	34.6	2400	155	144
	30	80	720	36.5	3977	34.9	3539	151	141
3000K	20	90	480	36.2	2238	34.6	1992	129	120
	30	90	720	36.5	3301	34.9	2937	126	117
4000K	20	80	480	36.2	2858	34.6	2544	165	153
	30	80	720	36.5	4215	34.9	3751	160	149
5000K	20	80	480	36.2	2885	34.6	2568	166	154
	30	80	720	36.5	4255	34.9	3787	162	151

Notes

1. All of V_F value are typical, the real bin range please refer page 12 "V_F Binning Parameter".
2. All of flux value are typical, the real bin range please refer page 12 "Flux Binning Parameter".
3. Tolerance of flux is ±7%, tolerance of CCX/CCY is ±0.007, tolerance of CRI is ±2, and tolerance of V_F is ±3%.
4. Typical viewing angle is 120deg.

LIGHT LED M04 CoB Product Series

4.2 Forward Current vs. Lumen Voltage

■ M04520 Series

Current (mA)	V _F (V)	Lumen (lm)			
		3000K CRI 80	3000K CRI 90	4000K CRI 80	5000K CRI 80
360	35.2	2106	1748	2233	2254
440	35.8	2500	2075	2650	2675
480	36.2	2696	2238	2858	2885
520	36.5	2892	2401	3066	3095
600	37.2	3286	2727	3483	3516
680	37.8	3679	3054	3900	3937
760	38.5	4073	3380	4317	4358
840	39.2	4466	3707	4734	4779
920	39.9	4859	4033	5150	5199
1000	40.5	5252	4359	5567	5620

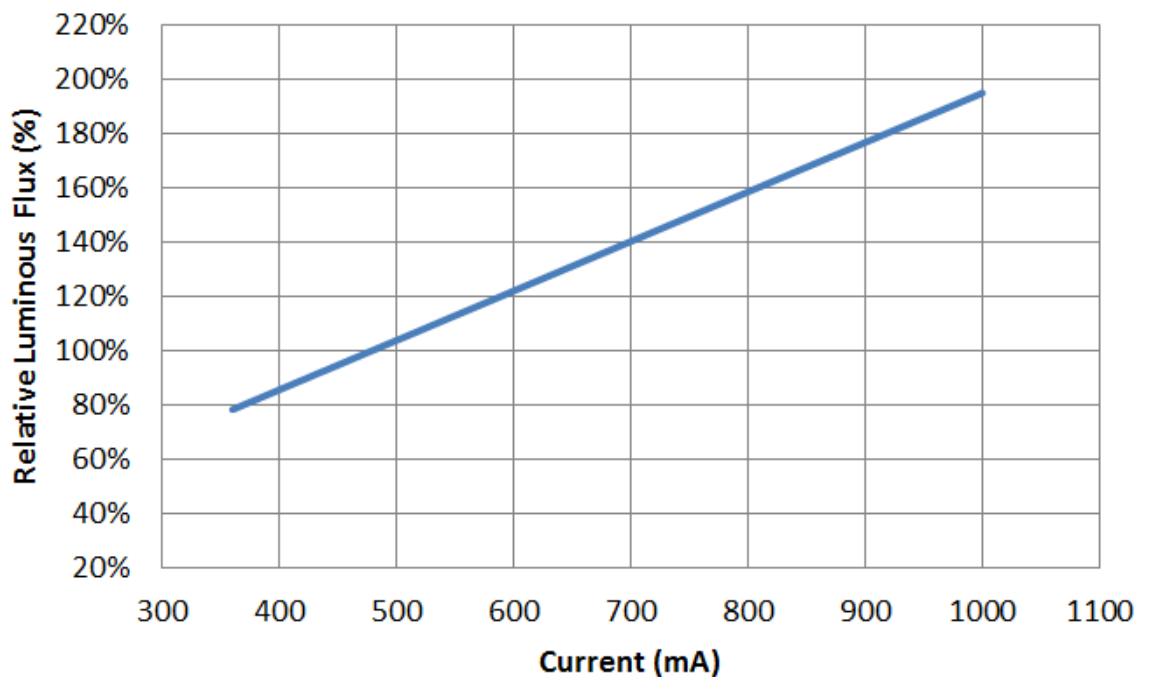

LIGHT LED M04 CoB Product Series

■ M04530 Series

Current (mA)	V _F (V)	Lumen (lm)			
		3000K CRI 80	3000K CRI 90	4000K CRI 80	5000K CRI 80
520	34.8	3008	2497	3188	3219
630	35.7	3541	2939	3753	3789
720	36.5	3977	3301	4215	4255
740	36.7	4074	3381	4318	4359
850	37.6	4607	3824	4883	4929
960	38.5	5140	4266	5448	5500
1070	39.4	5673	4708	6013	6070
1180	40.3	6206	5151	6578	6640
1290	41.3	6738	5592	7142	7209
1400	42.2	7271	6035	7707	7779

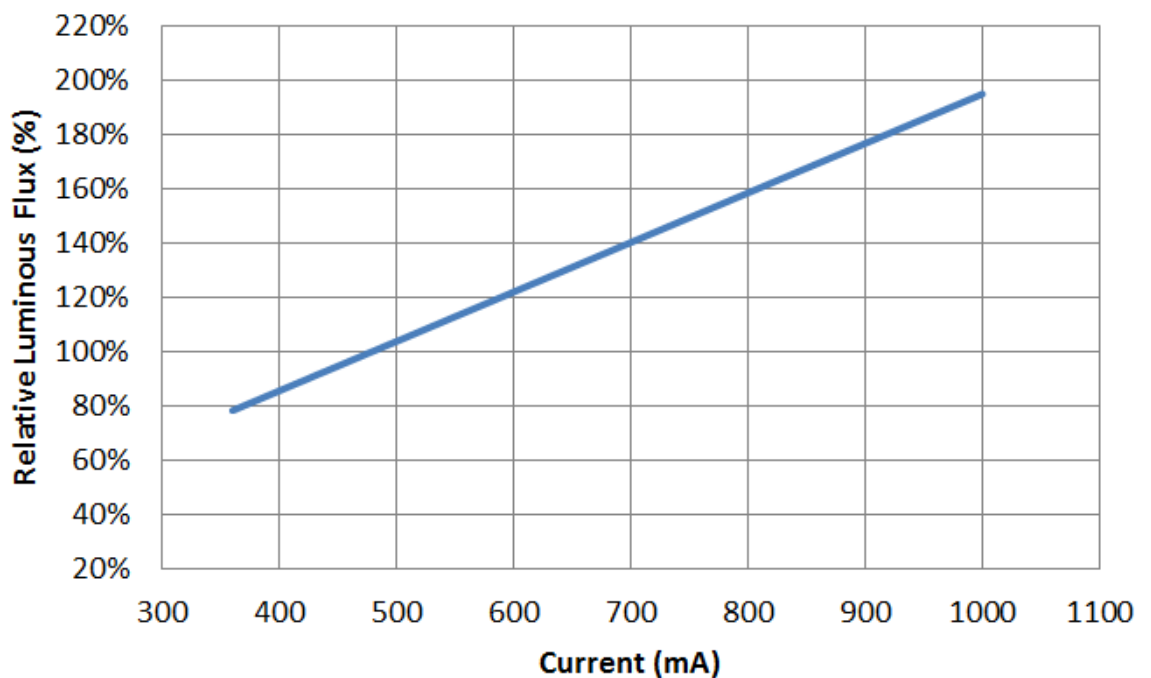

LIGHT LED M04 CoB Product Series

4.3 Relative Spectral Power Distribution at Typical Current

3000K CRI 80 Series Product

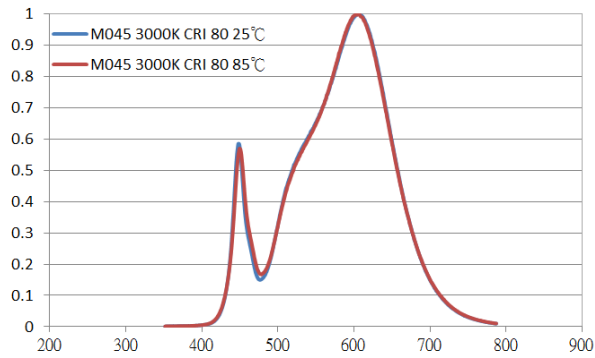

3000K CRI 90 Series Product

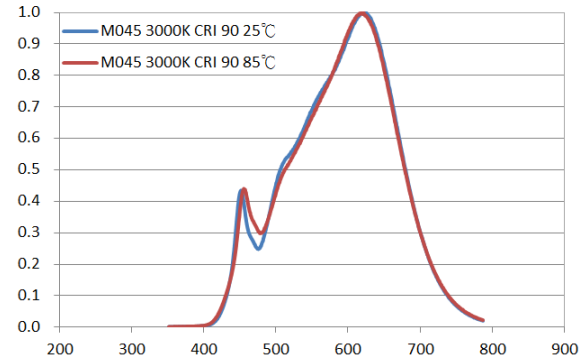

4.4 Radiation Characteristics

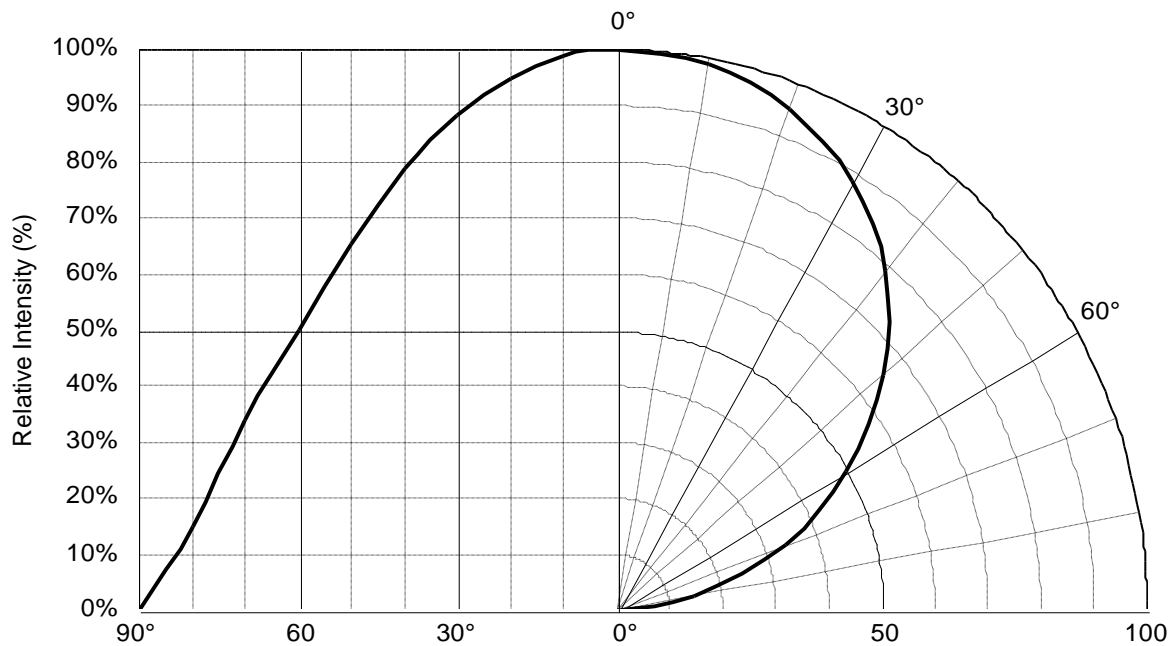

LIGHT LED M04 CoB Product Series

4.5. Forward Current vs. Forward Voltage

M04520 Series

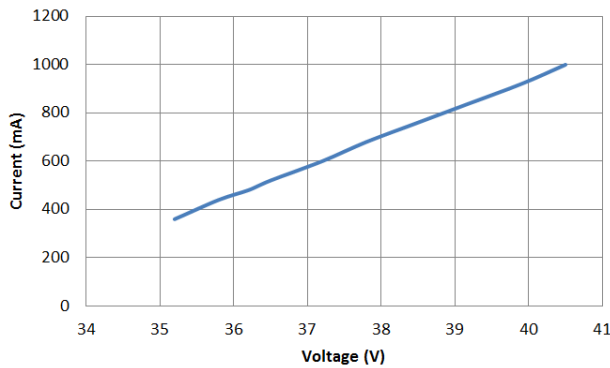

M04530 Series

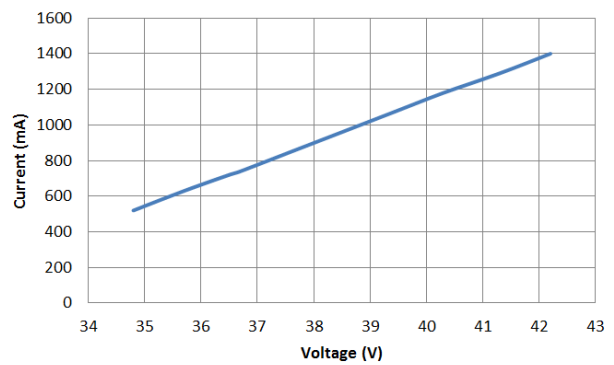

4.6. Forward Current Degrading Curve

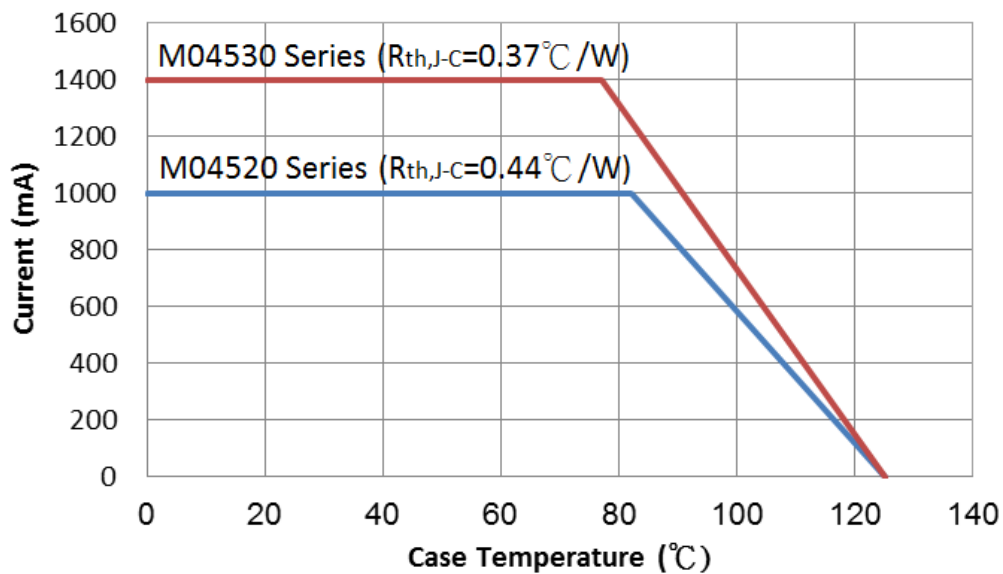

**LIGHT LED
M04 CoB Product Series**

4.7 Relative Intensity vs. Case Temperature

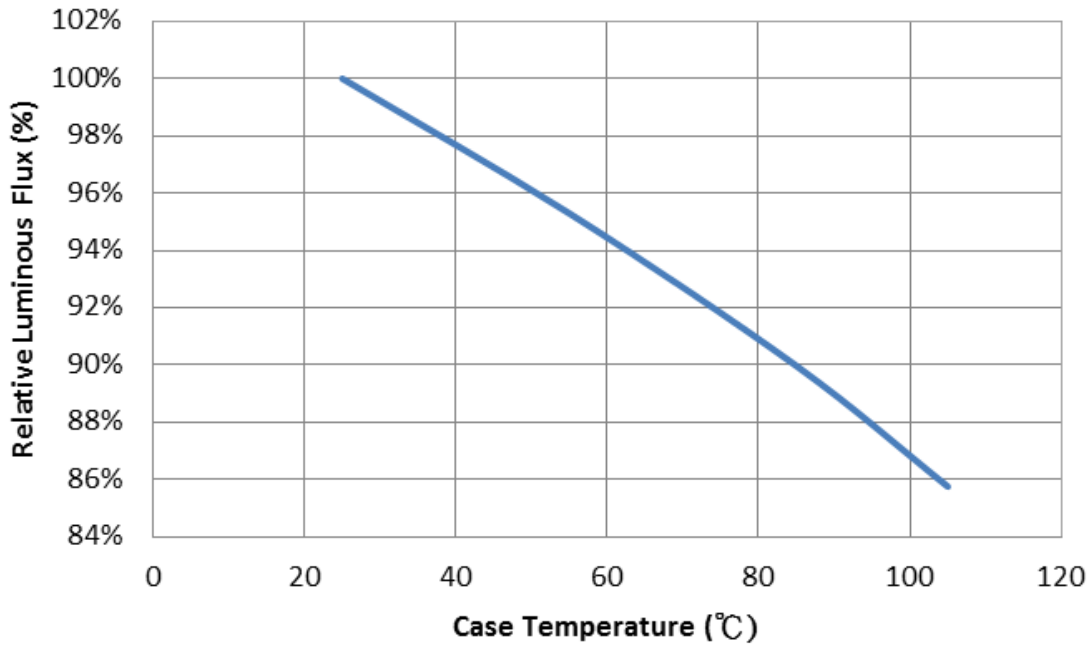

4.8 Relative Forward Voltage vs. Case Temperature

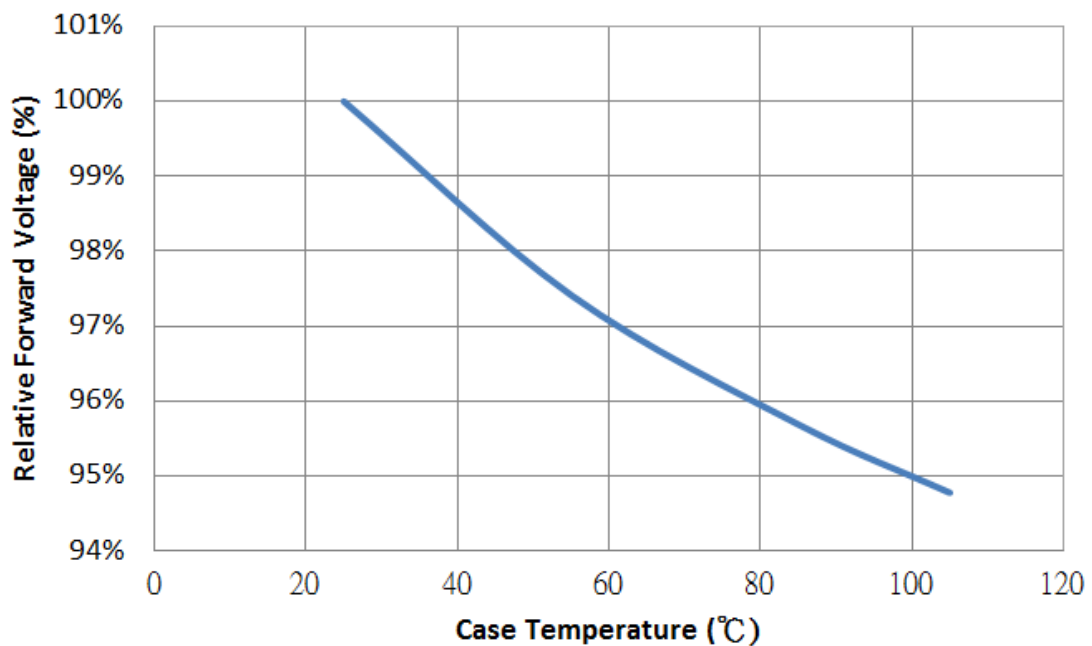

LIGHT LED M04 CoB Product Series

5 CoB Binning Definition

■ Flux Binning Parameter (25°C)

Lumen CODE List of M04 Series Product			
Parameter	Code	Unit	Lumen
Luminous Flux	C	lm	1830
	D		1975
	E		2130
	F		2300
	G		2485
	H		2680
	I		2890
	J		3120
	K		3370
	L		3640
	M		3925
	N		4240
	O		4575
	P		4940
	Q		5330

■ Example of M04 Series Product Bin (3000K 20W series)

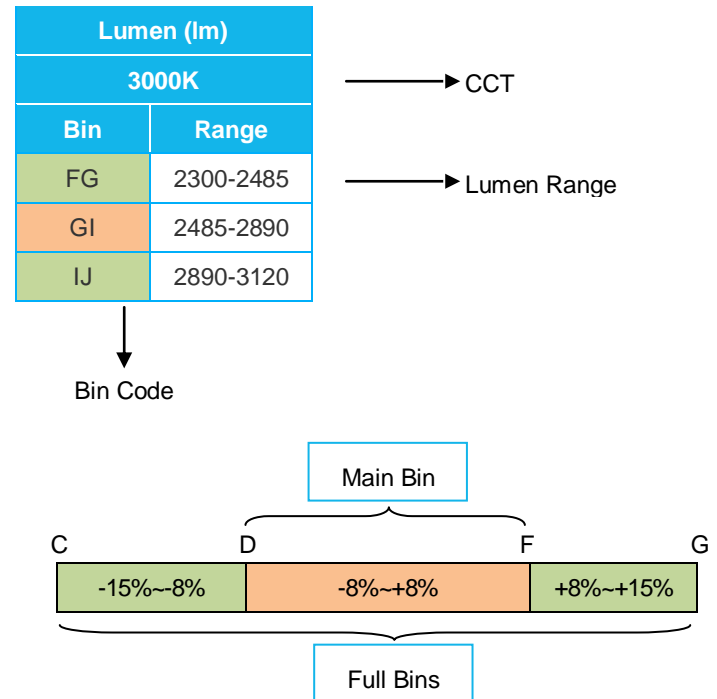

LIGHT LED M04 CoB Product Series

■ M04520 Series Lumen Bin

Lumen (lm)							
3000K CRI 80		3000K CRI 90		4000K CRI 80		5000K CRI 80	
Bin	Range	Bin	Range	Bin	Range	Bin	Range
FG	2300~2485	CD	1830~1975	GH	2485~2680	GH	2485~2680
GI	2485~2890	DF	1975~2300	HJ	2680~3120	HJ	2680~3120
IJ	2890~3120	FG	2300~2485	JK	3120~3370	JK	3120~3370

■ M04530 Series Lumen Bin

Lumen (lm)							
3000K CRI 80		3000K CRI 90		4000K CRI 80		5000K CRI 80	
Bin	Range	Bin	Range	Bin	Range	Bin	Range
KL	3370~3640	IJ	2980~3120	LM	3640~3925	LM	3640~3925
LN	3640~4240	JL	3120~3640	MO	3925~4575	MO	3925~4575
NO	4240~4575	LM	3640~3925	OP	4575~4940	OP	4575~4940

■ Forward Voltage Binning Parameter (25°C)

M04520 and M04530 series

Parameter	Bin	Symbol	Min	Max	Unit	Condition
Forward Voltage	V1	VF	33	42	V	IF =Typical Current

Note: Full Rank on Label

Example: V1/HJ/D1

Forward Voltage Rank	Luminous Flux Rank	Color Rank
V1	HJ	D1

LIGHT LED M04 CoB Product Series

■ Example of LiteOn CoB MacAdam Ellipse Color Definition (EX: 3000K)

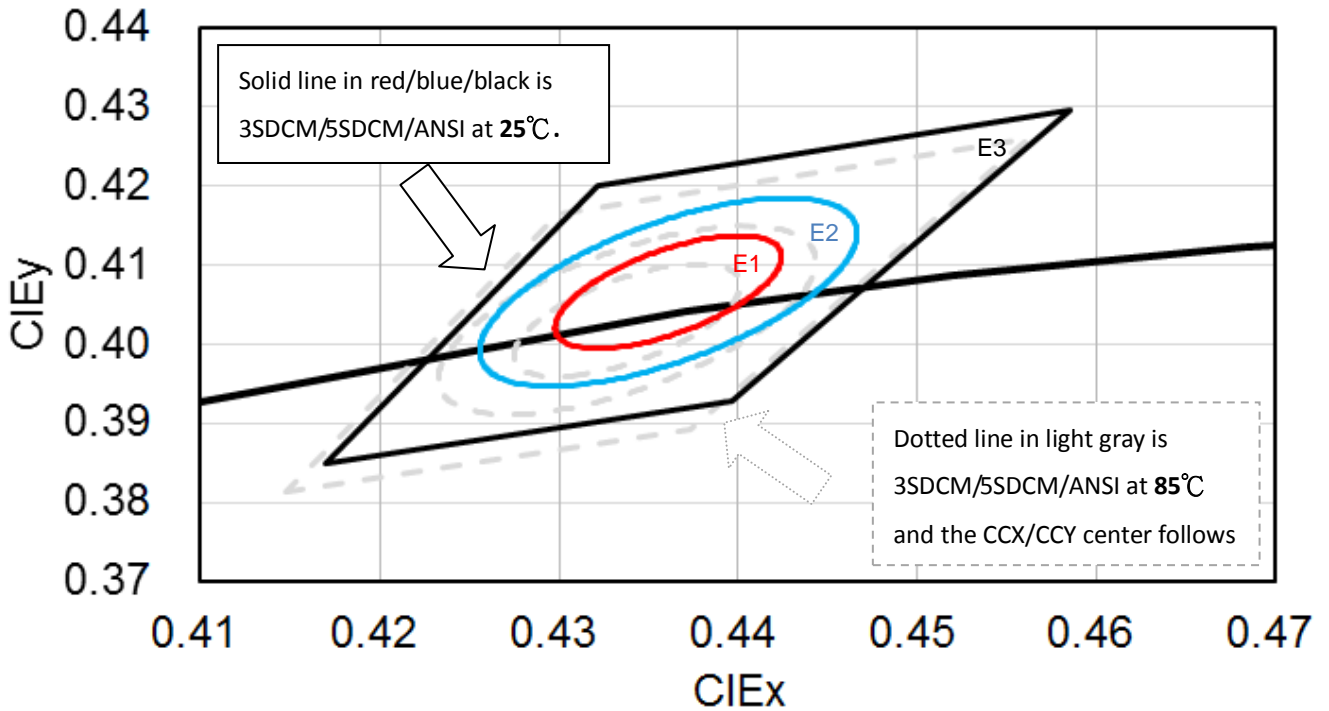

CIE Center Point						
CCT	25degC (LiteOn Spec.)		85degC (ANSI)		Hot/Cold Factor	
	CCX	CCY	CCX	CCY	CCX	CCY
3000	0.4361	0.4066	0.4338	0.4030	-0.0023	-0.0036
4000	0.3850	0.3848	0.3818	0.3797	-0.0032	-0.0051
5000	0.3494	0.3631	0.3447	0.3553	-0.0047	-0.0076

Notes

1. LiteOn tester and shipping spec follow the color bin with 25degC CCX/CCY center.
2. The Hot/Cold factor means the CCX/CCY shift from 25degC to 85degC.
3. The Hot/Cold shift is measured by LiteOn CAS 140B instrument system.
4. The ellipse equation expression: $SDCM = (g11*(x-x_0)^2 + 2*g12*(x-x_0)*(y-y_0) + g22*(y-y_0)^2)^{0.5}$

LIGHT LED M04 CoB Product Series

■ M045 3000K

PN: LTPL-M045 Series 3000K

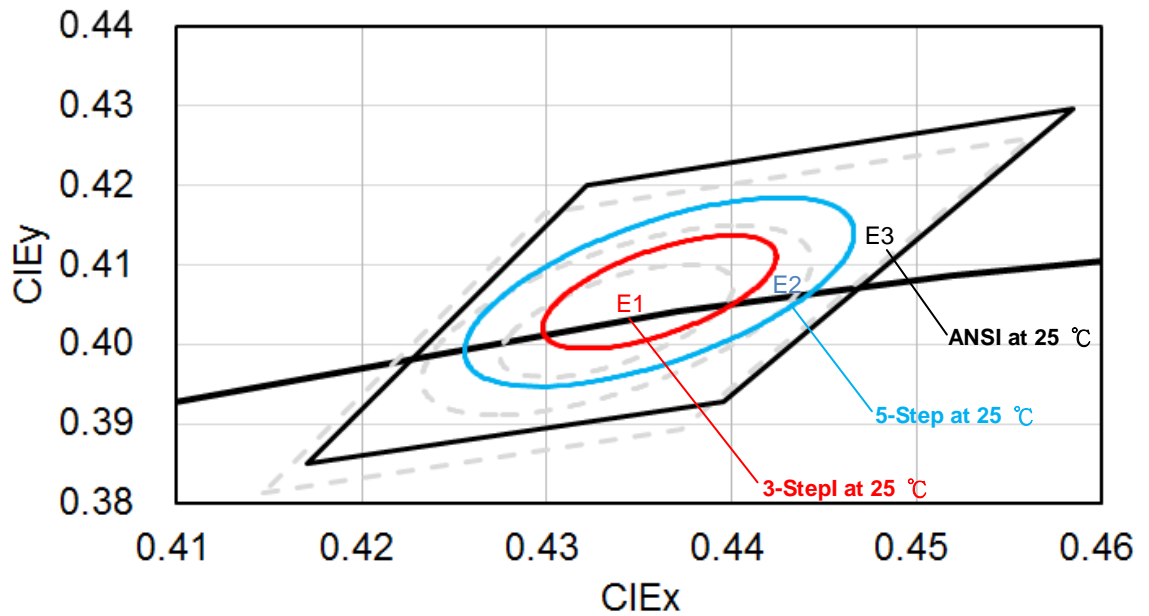

■ M045 4000K

PN: LTPL-M045 Series 4000K

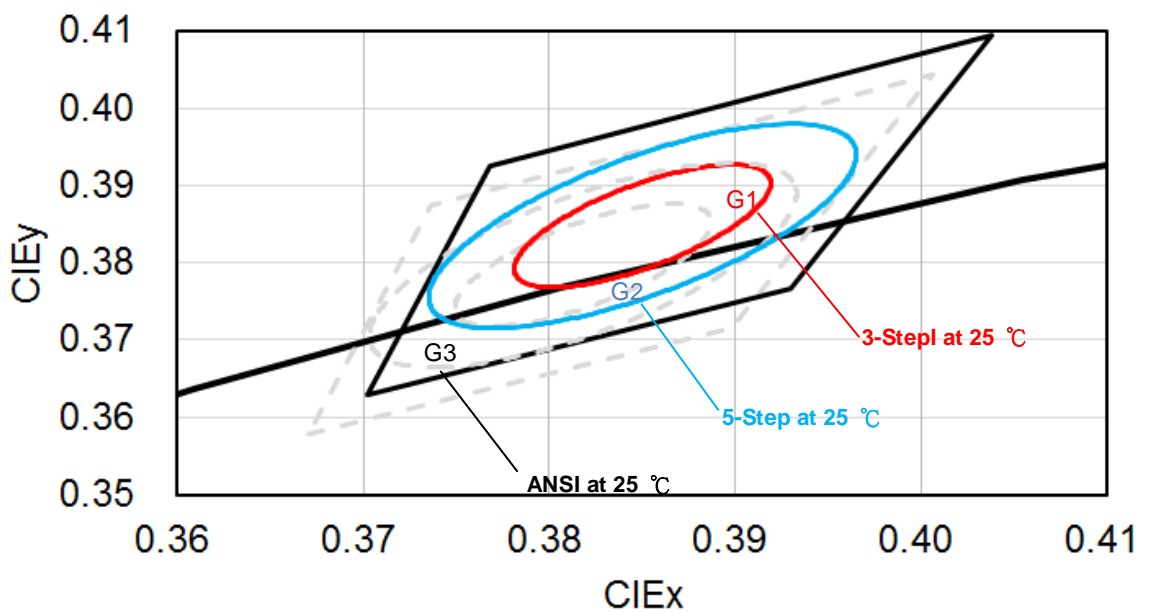

LIGHT LED
M04 CoB Product Series

■ M045 5000K

PN: LTPL-M045 Series 5000K

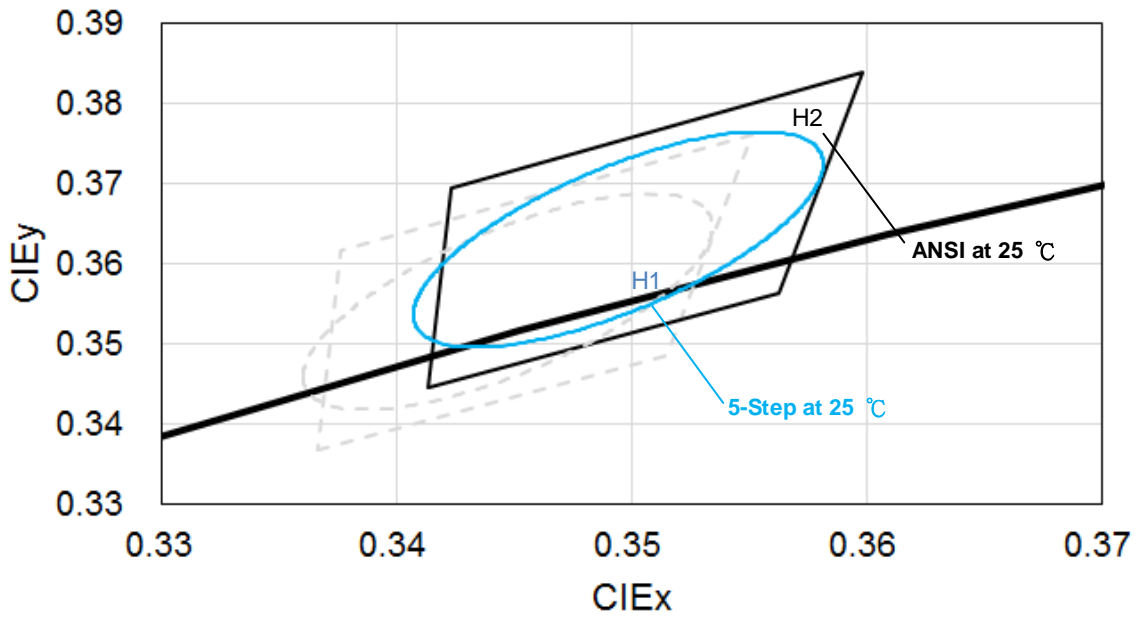

LIGHT LED M04 CoB Product Series

6. Reliability Test Plan

No	Test item	Condition	Duration	Number of Failed	Result
1	High Temperature Operating Life	$T_c=85^{\circ}\text{C}$, I_F =Typical Current	1K hours	0/10	Pass
2	Wet High Temperature Operating Life	$60^{\circ}\text{C}/90\%\text{RH}$, I_F =Typical Current(DC) 30 mins ON/OFF	1K hours	0/10	Pass
3	Thermal Shock	-40°C to 125°C , 15minutes dwell, <10 seconds transfer, measurement in every 250 cycles	500 cycles	0/10	Pass
4	Fast Switch Cycling Test	40000cycles, 2 mins On/Off, Room temperature($25^{\circ}\text{C} \pm 5^{\circ}\text{C}$), measurement in every 5000 cycles	40K cycles	0/10	Pass
5	High Temperature Storage Life	$T_a=120^{\circ}\text{C}$	1K hours	0/10	Pass
6	Low Temperature Storage Life	$T_a=-55^{\circ}\text{C}$	1K hours	0/10	Pass
7	Mechanical Shock	1500G, 0.5ms pulse, 5 shocks each 6 axis	30 Times (5 shocks each 6 axis)	0/10	Pass
8	Variable Vibration Frequency	10-2000-10 Hz, log or linear sweep rate, 20G for approximately minute 1.5mm, each applied three times per axis over 6 hrs.	18 hrs (3 times per axis over 6 hrs)	0/10	Pass

■ Criteria for Judging the Damage

Item	Symbol	Test Condition	Criteria for Judgment	
			Min.	Max.
Forward Voltage	V_F	I_F =Typical Current		U.S.L. x 1.1
Luminous Flux	Lm	I_F =Typical Current	L.S.L. x 0.7	
CCX & CCY	X,Y	I_F =Typical Current		Shift<0.02

Notes: 1.Operating life tests are mounted on thermal heat sink
2..Storage items are only component, not put on heat sink.

LIGHT LED M04 CoB Product Series

7. Packing Specifications

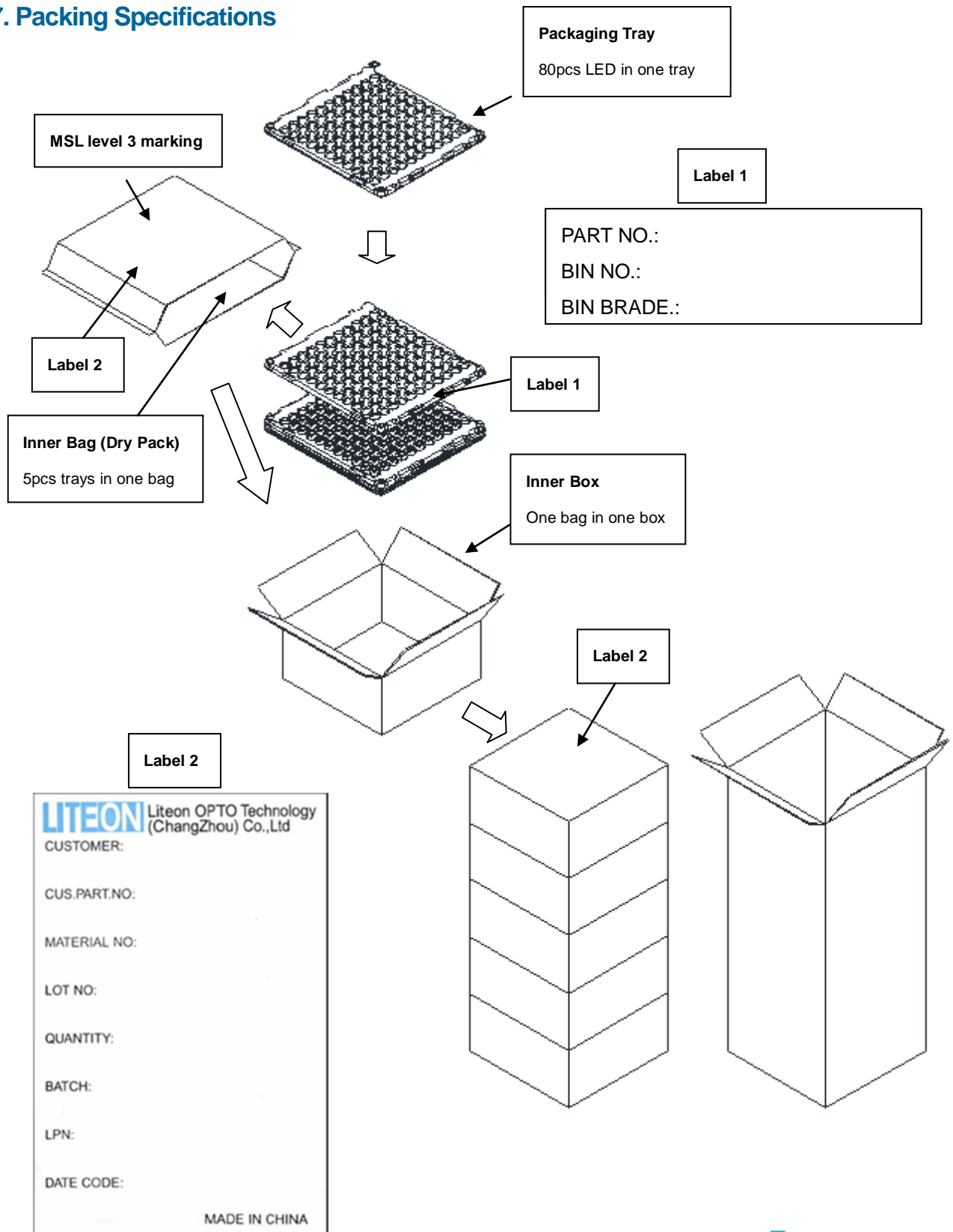

LIGHT LED M04 CoB Product Series

8. Cautions

8.1 An LED is a current-operated device. In order to ensure intensity uniformity on multiple LEDs connected in parallel in an application, it is recommended that a current limiting resistor be incorporated in the drive circuit, in series with each LED as shown in circuit below.

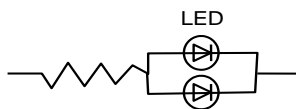

(A) Recommended circuit.

(B) The brightness of each LED might appear different due to the differences in the I-V characteristics of those LEDs.

8.2 Do not put any pressure on the light emitting surface either by finger or any hand tool and do not stack the COB products. Stress or pressure may cause damage to the wires of the LED array.

8.3 This product is not designed for the use under any of the following conditions, please confirm the performance and reliability are well enough if you use it under any of the following conditions

- Do not use sulfur-containing materials in commercial products including the materials such as seals and adhesives that may contain sulfur.
- Do not put this product in a place with a lot of moisture (over 85% relative humidity), dew condensation, briny air, and corrosive gas (Cl, H₂S, NH₃, SO₂, NO_x, etc.), exposure to a corrosive environment may affect silver plating.

ESD (Electrostatic Discharge)

Static Electricity or power surge will damage the LED. Suggestions to prevent ESD damage:

- Use of a conductive wrist band or anti-electrostatic glove when handling these LEDs.
- All devices, equipment, and machinery must be properly grounded.
- Work tables, storage racks, etc. should be properly grounded.
- Use ion blower to neutralize the static charge which might have built up on surface of the LED's plastic lens as a result of friction between LEDs during storage and handling.

ESD-damaged LEDs will exhibit abnormal characteristics such as high reverse leakage current, low forward voltage, or “no light up” at low currents.

To verify for ESD damage, check for “light up” and V_F of the suspect LEDs at low currents.

Looking for pricing, stock, or lifecycle information?

Click below to explore more details on WIN SOURCE:

- [View LTPL-M04520QS30-T0 on WIN SOURCE](#)
- [Lite-On Inc. Information](#)

Optimize Your Supply Chain with WIN SOURCE Solutions

- ✓ Global Sourcing Solution
- ✓ Obsolete Management
- ✓ Cost Control Management
- ✓ Shortage Management
- ✓ Alternative Solution
- ✓ Excess Inventory Management