



**THE DATASHEET OF
CP0603A0836AWTR**



Thin-Film Directional Couplers



CP0603 SMD Type

GENERAL DESCRIPTION ITF (Integrated Thin-Film) TECHNOLOGY

The ITF SMD Coupler is based on thin-film multilayer technology. The technology provides a miniature part with excellent high frequency performance and rugged construction for reliable automatic assembly. The ITF Coupler is offered in a variety of frequency bands compatible with various types of high frequency wireless systems.

DIMENSIONS:

millimeters (inches)

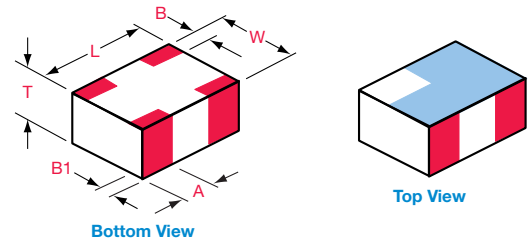

	0603
L	1.6±0.1 (0.063±0.004)
W	0.84±0.1 (0.033±0.004)
T	0.60±0.1 (0.028±0.004)
A	0.35±0.15 (0.014±0.006)
B	0.175±0.1 (0.007±0.004)
B1	0.00+0.1/0-0.0 (0.00+0.004/-0.0)

APPLICATIONS

- Mobile Communications
- Satellite TV Receivers
- GPS
- Vehicle Location Systems
- Wireless LAN's

FEATURES

- Miniature Size: 0603
- Frequency Range: 800MHz - 3GHz
- Characteristic Impedance: 50Ω
- Operating / Storage Temp.: -40°C to +85°C
- Power Rating: 3W Continuous
- Low Profile
- Rugged Construction
- Taped and Reeled

HOW TO ORDER

CP ↓ Style Directional Coupler	0603 ↓ Size 0603	X ↓ Type	**** ↓ Frequency MHz	X ↓ Sub Type	S ↓ Termination Code W = Sn90, Pb10 **S = Sn100	TR ↓ Packaging Code TR = Tape and Reel
---	---	------------------------------	---	----------------------------------	---	---

****RoHS compliant**

QUALITY INSPECTION

Finished parts are 100% tested for electrical parameters and visual characteristics. Each production lot is evaluated on a sample basis for:

- Static Humidity: 85°C, 85% RH, 160 hours
- Endurance: 125°C, I_R, 4 hours

TERMINATION

Nickel/Solder coating compatible with automatic soldering technologies: reflow, wave soldering, vapor phase and manual.

Recommended Pad Layout Dimensions mm (inches)

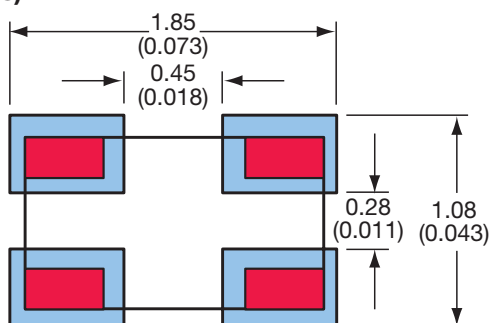

TERMINALS (Top View)

Not RoHS Compliant

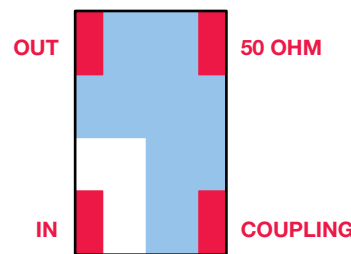

For RoHS compliant products, please select correct termination style.

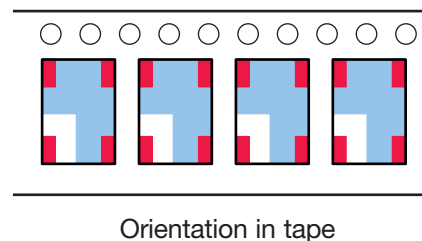

Thin-Film Directional Couplers



CP0603 SMD Type

Coupler P/N CP0603A****AS

Application	P/N Examples	Frequency Band [MHz]	Coupling [dB]	I. Loss max	VSWR max
AMPS	CP0603A0836AS	824 - 849	18.5±1	0.25	1.2
	CP0603A0881AS	869 - 894	18.5±1		
GSM	CP0603A0902AS	890 - 915	18±1	0.25	
	CP0603A0947AS	935 - 960	17.5±1		
E-GSM	CP0603A0897AS	880 - 915	18±1	0.4	
	CP0603A0942AS	925 - 960	17.5±1		
PDC	CP0603A1441AS	1429 - 1453	14±1	0.4	
PCN	CP0603A1747AS	1710 - 1785	12.5±1	0.6	
	CP0603A1842AS	1805 - 1880	12±1		
PCS	CP0603A1880AS	1850 - 1910	12±1	0.65	
	CP0603A1960AS	1930 - 1990	11.5±1		
PHP	CP0603A1907AS	1895 - 1920	12±1	0.6	
DECT	CP0603A1890AS	1880 - 1900	12±1	0.6	
Wireless LAN	CP0603A2442AS	2400 - 2484	10±1	0.85	

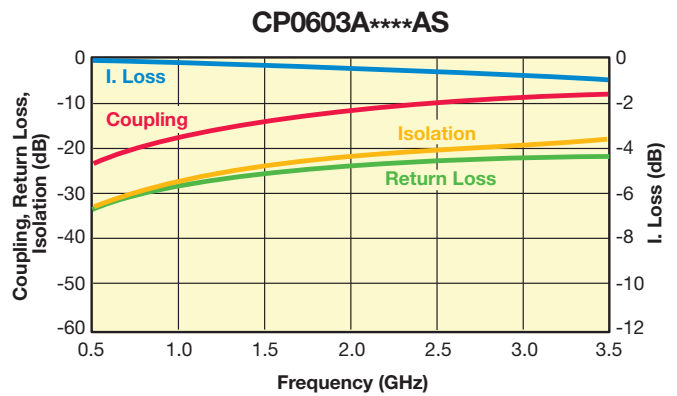

Coupler P/N CP0603A****BS

Application	P/N Examples	Frequency Band [MHz]	Coupling [dB]	I. Loss max	VSWR max
AMPS	CP0603A0836BS	824 - 849	16±1	0.25	1.2
	CP0603A0881BS	869 - 894	15.5±1		
GSM	CP0603A0902BS	890 - 915	15.5±1	0.25	
	CP0603A0947BS	935 - 960	15±1		
E-GSM	CP0603A0897BS	880 - 915	15.5±1	0.55	
	CP0603A0942BS	925 - 960	15±1		
PDC	CP0603A1441BS	1429 - 1453	11.5±1	0.55	
PCN	CP0603A1747BS	1710 - 1785	10±1	0.8	
	CP0603A1842BS	1805 - 1880	9.5±1		
PCS	CP0603A1880BS	1850 - 1910	9±1	0.8	
	CP0603A1960BS	1930 - 1990	9±1		
PHP	CP0603A1907BS	1895 - 1920	9±1	0.8	
DECT	CP0603A1890BS	1880 - 1900	9±1	0.8	
Wireless LAN	CP0603A2442BS	2400 - 2484	7.5±1	1.1	

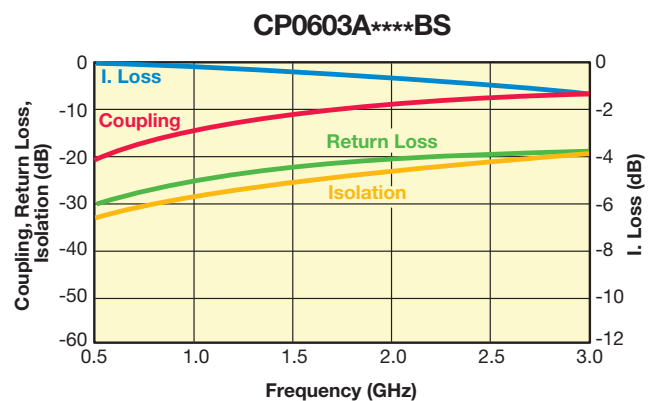

Coupler P/N CP0603A****CS

Application	P/N Examples	Frequency Band [MHz]	Coupling [dB]	I. Loss max	VSWR max
AMPS	CP0603A0836CS	824 - 849	21±1	0.25	1.2
	CP0603A0881CS	869 - 894	20.5±1		
GSM	CP0603A0902CS	890 - 915	20.5±1	0.25	
	CP0603A0947CS	935 - 960	20±1		
E-GSM	CP0603A0897CS	880 - 915	20.5±1	0.40	
	CP0603A0942CS	925 - 960	20±1		
PDC	CP0603A1441CS	1429 - 1453	16.5±1	0.40	
PCN	CP0603A1747CS	1710 - 1785	15±1	0.5	
	CP0603A1842CS	1805 - 1880	14.5±1		
PCS	CP0603A1880CS	1850 - 1910	14.5±1	0.5	
	CP0603A1960CS	1930 - 1990	14±1		
PHP	CP0603A1907CS	1895 - 1920	14.5±1	0.5	
DECT	CP0603A1890CS	1880 - 1900	14.5±1	0.5	
Wireless LAN	CP0603A2442CS	2400 - 2484	12.5±1	0.65	

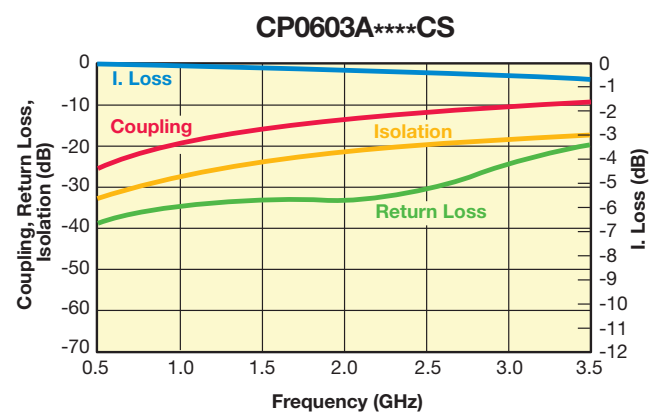

Coupler P/N CP0603A****DS

Application	P/N Examples	Frequency Band [MHz]	Coupling [dB]	I. Loss max	VSWR max
AMPS	CP0603A0836DS	824 - 849	15.0±1	0.40	1.2
	CP0603A0881DS	869 - 894	14.5±1		
GSM	CP0603A0902DS	890 - 915	14.5±1	0.40	
	CP0603A0947DS	935 - 960	14±1		
E-GSM	CP0603A0897DS	880 - 915	14.5±1	0.7	
	CP0603A0942DS	925 - 960	14±1		
PDC	CP0603A1441DS	1429 - 1453	10.5±1	0.7	
PCN	CP0603A1747DS	1710 - 1785	9±1	0.9	
	CP0603A1842DS	1805 - 1880	8.5±1		
PCS	CP0603A1880DS	1850 - 1910	8.5±1	1.0	
	CP0603A1960DS	1930 - 1990	8±1		
PHP	CP0603A1907DS	1895 - 1920	8.5±1	1.0	
DECT	CP0603A1890DS	1880 - 1900	8.5±1	1.0	
Wireless LAN	CP0603A2442DS	2400 - 2484	6.5±1	1.5	

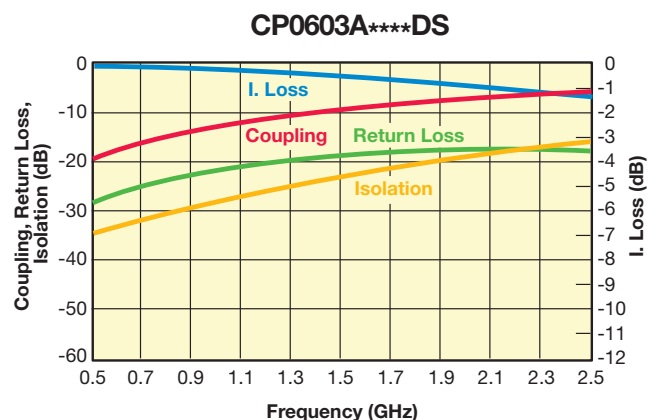

Important: Couplers can be used at any frequency within the indicated range.



Thin-Film Directional Couplers



CP0603 SMD Type

Coupler P/N CP0603B****AS

Application	P/N Examples	Frequency Band [MHz]	Coupling [dB]	I. Loss max	VSWR max
AMPS	CP0603B0836AS	824 - 849	24.5±1	0.2	1.2
	CP0603B0881AS	869 - 894	24±1		
GSM	CP0603B0902AS	890 - 915	24±1		
	CP0603B0947AS	935 - 960	23.5±1		
E-GSM	CP0603B0897AS	880 - 915	24±1		
	CP0603B0942AS	925 - 960	23.5±1		
PDC	CP0603B1441AS	1429 - 1453	20±1	0.25	
PCN	CP0603B1747AS	1710 - 1785	18±1		
PCS	CP0603B1842AS	1805 - 1880	17.5±1	0.3	
	CP0603B1880AS	1850 - 1910	17.5±1		
PHP	CP0603B1960AS	1930 - 1990	17.5±1		
DECT	CP0603B1907AS	1895 - 1920	17.5±1	0.45	
Wireless LAN	CP0603B1890AS	1880 - 1900	17.5±1		
	CP0603B2442AS	2400 - 2484	15.5±1		

CP0603B****AS

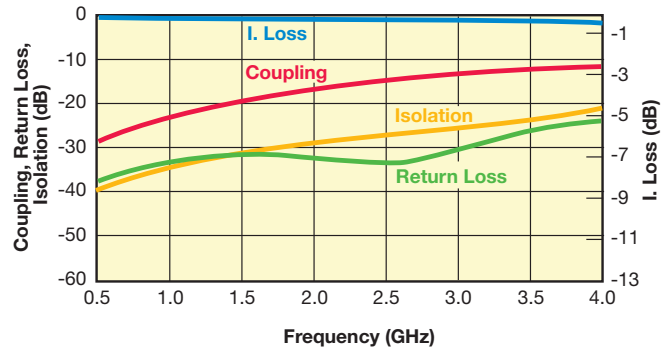

Coupler P/N CP0603B****BS

Application	P/N Examples	Frequency Band [MHz]	Coupling [dB]	I. Loss max	VSWR max
AMPS	CP0603B0836BS	824 - 849	25.5±1	0.2	1.2
	CP0603B0881BS	869 - 894	25±1		
GSM	CP0603B0902BS	890 - 915	25±1		
	CP0603B0947BS	935 - 960	24.5±1		
E-GSM	CP0603B0897BS	880 - 915	25±1		
	CP0603B0942BS	925 - 960	24.5±1		
PDC	CP0603B1441BS	1429 - 1453	21±1	0.25	
PCN	CP0603B1747BS	1710 - 1785	19±1		
PCS	CP0603B1842BS	1805 - 1880	19±1	0.25	
	CP0603B1880BS	1850 - 1910	18.5±1		
PHP	CP0603B1960BS	1930 - 1990	18.5±1		
DECT	CP0603B1907BS	1895 - 1920	18.5±1	0.35	
Wireless LAN	CP0603B1890BS	1880 - 1900	18.5±1		
	CP0603B2442BS	2400 - 2484	16.5±1		

CP0603B****BS

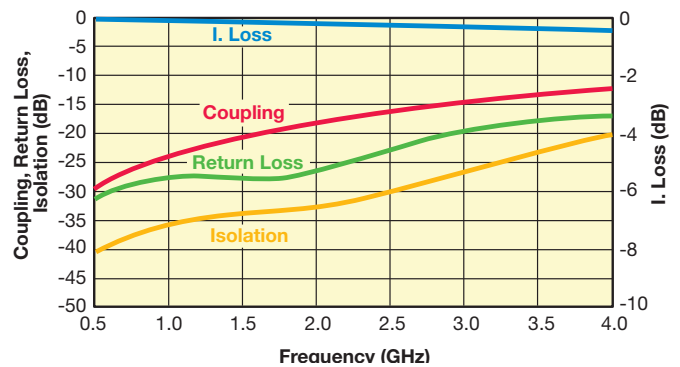

Coupler P/N CP0603B****CS

Application	P/N Examples	Frequency Band [MHz]	Coupling [dB]	I. Loss max	VSWR max
AMPS	CP0603B0836CS	824 - 849	26.5±1	0.2	1.2
	CP0603B0881CS	869 - 894	26±1		
GSM	CP0603B0902CS	890 - 915	26±1		
	CP0603B0947CS	935 - 960	25.5±1		
E-GSM	CP0603B0897CS	880 - 915	26±1		
	CP0603B0942CS	925 - 960	25.5±1		
PDC	CP0603B1441CS	1429 - 1453	22±1	0.25	
PCN	CP0603B1747CS	1710 - 1785	20.5±1		
PCS	CP0603B1842CS	1805 - 1880	20±1	0.25	
	CP0603B1880CS	1850 - 1910	20±1		
PHP	CP0603B1960CS	1930 - 1990	19.5±1		
DECT	CP0603B1907CS	1895 - 1920	20±1	0.35	
Wireless LAN	CP0603B1890CS	1880 - 1900	20±1		
	CP0603B2442CS	2400 - 2484	18±1		

CP0603B****CS

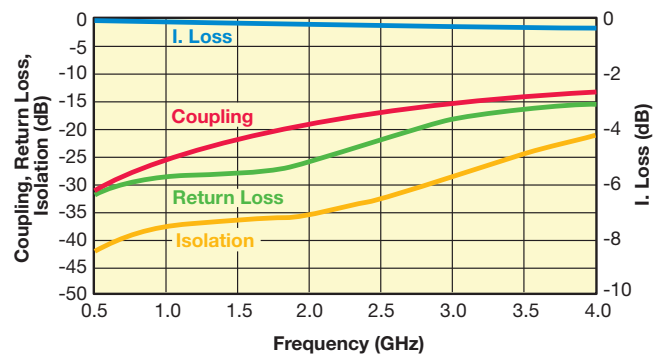

Important: Couplers can be used at any frequency within the indicated range.

Thin-Film Directional Couplers



CP0805 and CP0603 Test Jig

ITF TEST JIG FOR COUPLER TYPES 0805 AND 0603 SMD

GENERAL DESCRIPTION

This jig is designed for the testing of CP0805 and CP0603 series Directional Couplers using a vector network analyzer. It consists of a FR4 multi-layer substrate, having 50Ω microstrips as conducting lines and a ground plane in the middle layer, located at a distance of 0.2mm from the microstrips.

The connectors are SMA type (female), 'Johnson Components Inc.' Product P/N: 142-0701-881.

The jig is designed for a full 2-port calibration. LOAD calibration can be done either by a 50Ω SMA termination, or by soldering a 50Ω chip resistor at the 50Ω ports.

MEASUREMENT PROCEDURE

When measuring a component, it can be either soldered or pressed by a non-metallic stick until all four ports touch the appropriate pads. To measure the coupling (and the R. Loss) place the component on the Port 1 & Port 2 pads. Use two SMA 50Ω terminations (male) to terminate the ports, which are not connected to the network analyzer, and connect the network analyzer to the two ports. A 90° rotation of the component on its pads allows measuring a second parameter (I. Loss).

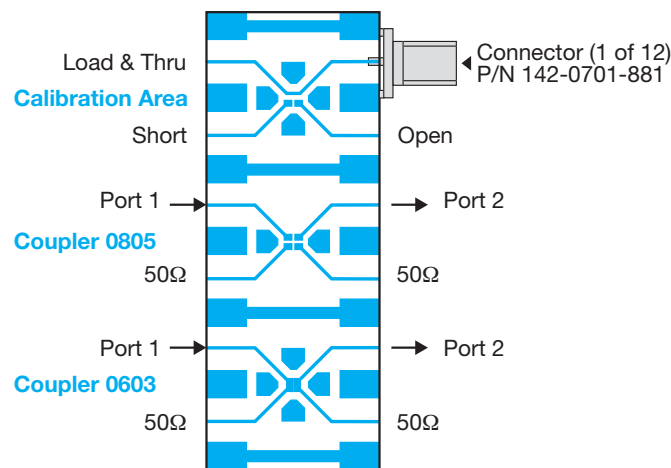

CP0805 SERIES DIRECTIONAL COUPLERS

Orientation and Tape and Reel Packaging Specification

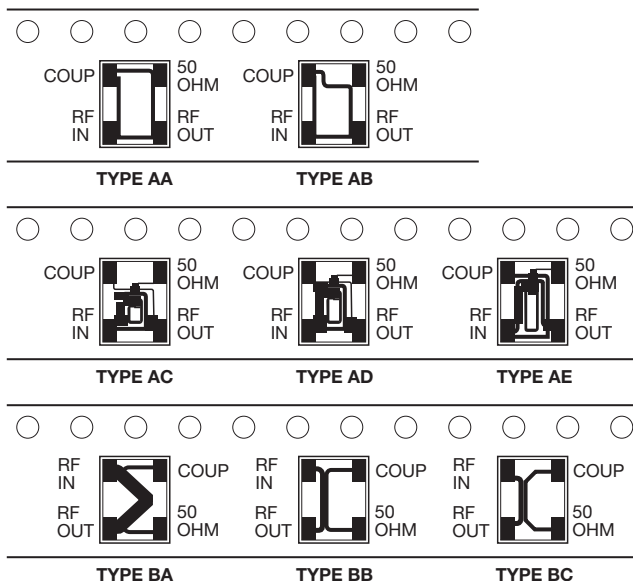

The parts should be mounted on the PCB with White (Alumina) side down and the "dark" side up.

CP0805xxxxxxSTR (Sn100)

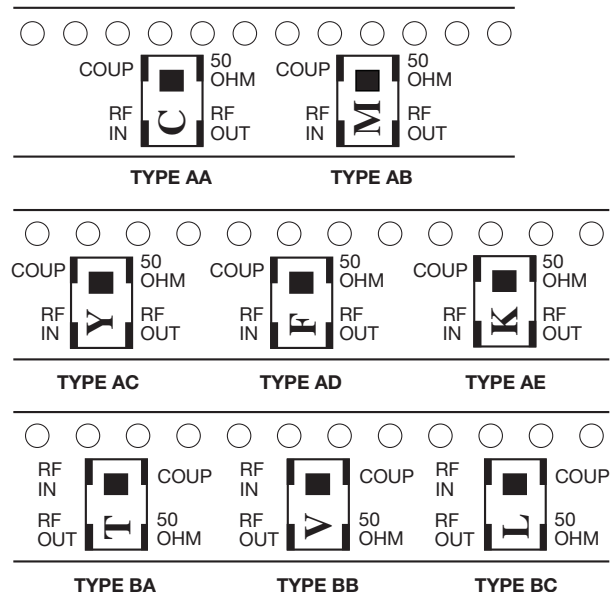

The parts should be mounted on the PCB with printed side up.



Looking for pricing, stock, or lifecycle information?

Click below to explore more details on WIN SOURCE:

 [View CP0603A0836AWTR on WIN SOURCE](#)

 [AVX Corporation](#) Information

Optimize Your Supply Chain with WIN SOURCE Solutions

-  Global Sourcing Solution
-  Obsolete Management
-  Cost Control Management
-  Shortage Management
-  Alternative Solution
-  Excess Inventory Management