



**THE DATASHEET OF  
EE-SX3161-W11**



## Photomicrosensor (Transmissive) EE-SX3161-W11/4161-W11

**⚠ Be sure to read Precautions on page 24.**

### ■ Dimensions

**Note:** All units are in millimeters unless otherwise indicated.

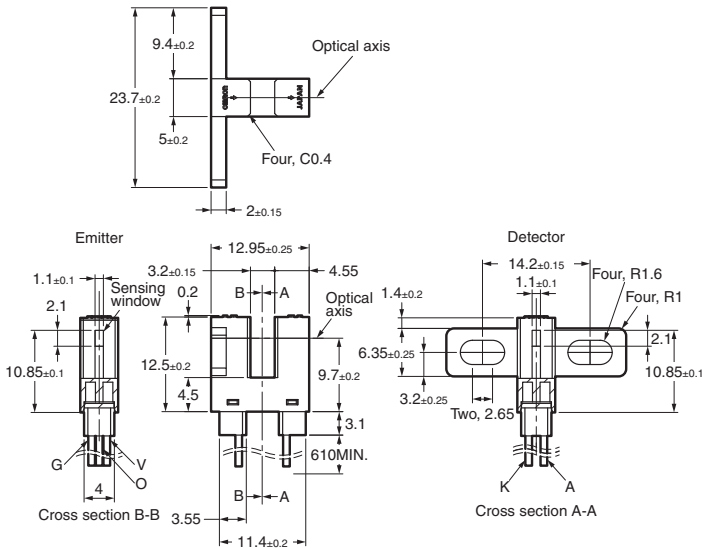

#### Internal Circuit

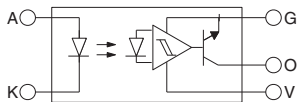

Unless otherwise specified, the tolerances are as shown below.

| Terminal No. | Color | Name                            |
|--------------|-------|---------------------------------|
| A            | Red   | Anode                           |
| K            | Black | Cathode                         |
| V            | White | Power supply (V <sub>CC</sub> ) |
| O            | Blue  | Output (OUT)                    |
| G            | Green | Ground (GND)                    |

| Dimensions   | Tolerance |
|--------------|-----------|
| 3 mm max.    | ±0.3      |
| 3 < mm ≤ 6   | ±0.375    |
| 6 < mm ≤ 10  | ±0.45     |
| 10 < mm ≤ 18 | ±0.55     |
| 18 < mm ≤ 30 | ±0.65     |

### ■ Features

- Dust-proof model.
- Light-receiving element and amplification circuits contained in one chip.
- Can use a power supply voltage of 4.5 to 16 V.
- Connects directly to C-MOS or TTL.
- Dark-ON Sensor: EE-SX3161-W11
- Light-ON Sensor: EE-SX4161-W11
- Pre-wired Sensors (AWG28).
- Solder-less lead wire connection to increase reliability.

### ■ Absolute Maximum Ratings (Ta = 25°C)

| Item                | Symbol                         | Rated value                          |
|---------------------|--------------------------------|--------------------------------------|
| Emitter             | Forward current                | I <sub>F</sub> 50 mA (see note 1)    |
|                     | Reverse voltage                | V <sub>R</sub> 4 V                   |
| Detector            | Power supply voltage           | V <sub>CC</sub> 16 V                 |
|                     | Output voltage                 | V <sub>OUT</sub> 28 V                |
|                     | Output current                 | I <sub>OUT</sub> 16 mA               |
|                     | Permissible output dissipation | P <sub>OUT</sub> 250 mW (see note 1) |
| Ambient temperature | Operating                      | T <sub>opr</sub> -25°C to 75°C       |
|                     | Storage                        | T <sub>stg</sub> -25°C to 85°C       |

- Note:**
1. Refer to the temperature rating chart if the ambient temperature exceeds 25°C.
  2. If you mount the Sensor with screws, use M3 screws, and flat washers and use a tightening torque of 0.5 N·m max.

### ■ Electrical and Optical Characteristics (Ta = 25°C)

| Item                           | Symbol                               | Value                                   | Condition   |
|--------------------------------|--------------------------------------|---|---|
| Emitter                        | Forward voltage                      | V <sub>F</sub> 1.2 V typ., 1.5 V max.   | I <sub>F</sub> = 20 mA  |
|                                | Reverse current                      | I <sub>R</sub> 0.01 μA typ., 10 μA max. | V <sub>R</sub> = 4 V  |
|                                | Peak emission wavelength             | λ <sub>P</sub> 940 nm                   | I <sub>F</sub> = 20 mA  |
| Detector                       | Low-level output voltage             | V <sub>OL</sub> 0.12 V typ., 0.4 V max. | V <sub>CC</sub> = 4.5 to 16 V, I <sub>OL</sub> = 16 mA, I <sub>F</sub> = 0 mA (EE-SX3161), I <sub>F</sub> = 10 mA (EE-SX4161) |
|                                | High-level output voltage            | V <sub>OH</sub> 15 V min.               | V <sub>CC</sub> = 16 V, R <sub>L</sub> = 1 kΩ, I <sub>F</sub> = 10 mA (EE-SX3161), I <sub>F</sub> = 0 mA (EE-SX4161)          |
|                                | Current consumption                  | I <sub>CC</sub> 3.2 mA typ., 10 mA max. | V <sub>CC</sub> = 16 V  |
|                                | Peak spectral sensitivity wavelength | λ <sub>P</sub> 870 nm                   | V <sub>CC</sub> = 4.5 to 16 V   |
| LED current when output is OFF | I <sub>FT</sub>                      | 2 mA typ., 10 mA max.                   | V <sub>CC</sub> = 4.5 to 16 V   |
| LED current when output is ON  |                                      |   |   |
| Hysteresis                     | ΔH                                   | 15% typ.                                | V <sub>CC</sub> = 4.5 to 16 V (see note 1)  |
| Response frequency             | f                                    | 3kHz min.                               | V <sub>CC</sub> = 4.5 to 16 V, I <sub>F</sub> = 15 mA, I <sub>OL</sub> = 16 mA (see note 2)                                   |
| Response delay time            | t <sub>PLH</sub> (t <sub>PHL</sub> ) | 3 μs typ.                               | V <sub>CC</sub> = 4.5 to 16 V, I <sub>F</sub> = 15 mA, I <sub>OL</sub> = 16 mA (see note 3)                                   |
| Response delay time            | t <sub>PHL</sub> (t <sub>PLH</sub> ) | 20 μs typ.                              | V <sub>CC</sub> = 4.5 to 16 V, I <sub>F</sub> = 15 mA, I <sub>OL</sub> = 16 mA (see note 3)                                   |

- Note:** 1. Hysteresis denotes the difference in forward LED current value, expressed in percentage, calculated from the respective forward LED currents when the photo IC in turned from ON to OFF and when the photo IC in turned from OFF to ON.
2. The value of the response frequency is measured by rotating the disk as shown below.

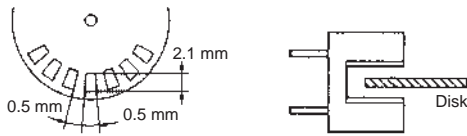

3. The following illustrations show the definition of response delay time. The value in the parentheses applies to the EE-SX4161.

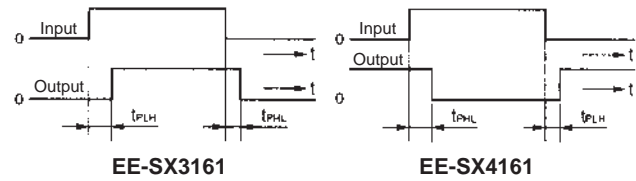

## Engineering Data

**Note:** The values in the parentheses apply to the EE-SX4161.

**Forward Current vs. Collector Dissipation Temperature Rating**

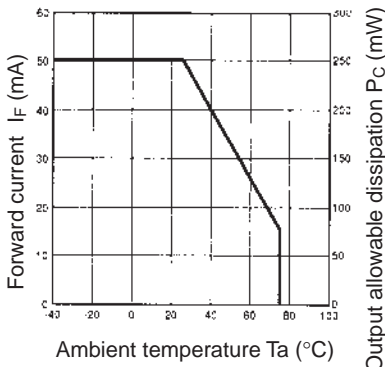

**Forward Current vs. Forward Voltage Characteristics (Typical)**

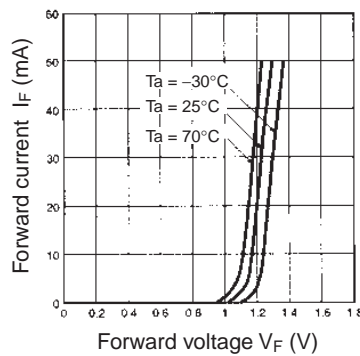

**LED Current vs. Supply Voltage (Typical)**

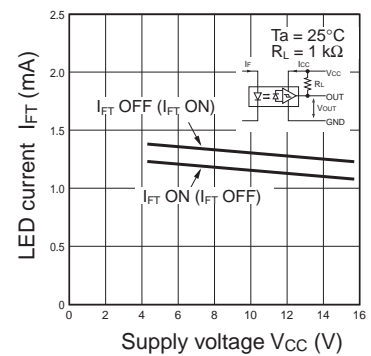

**LED Current vs. Ambient Temperature Characteristics (Typical)**

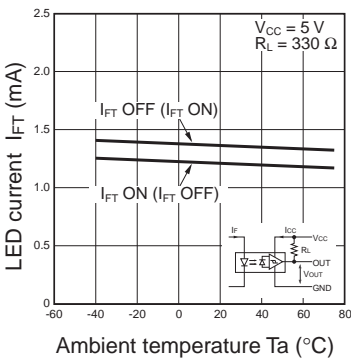

**Low-level Output Voltage vs. Output Current (Typical)**

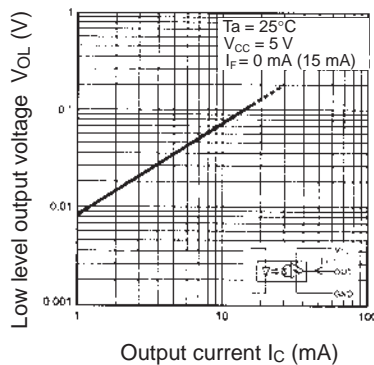

**Low-level Output Voltage vs. Ambient Temperature Characteristics (Typical)**

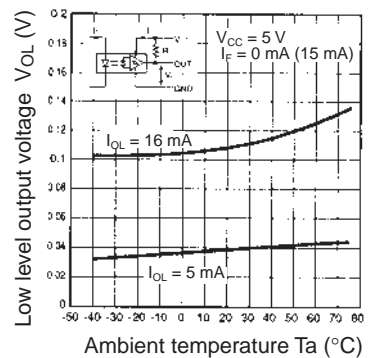

**Current Consumption vs. Supply Voltage (Typical)**

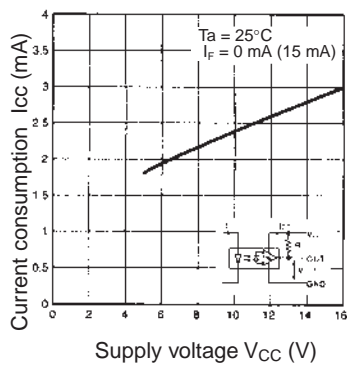

**Response Delay Time vs. Forward Current (Typical)**

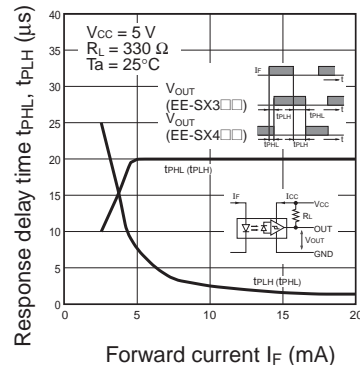

**Repeat Sensing Position Characteristics (Typical)**

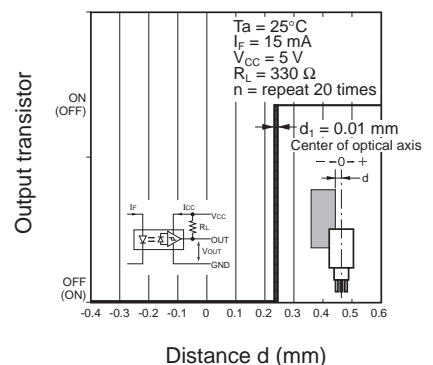

## Looking for pricing, stock, or lifecycle information?

Click below to explore more details on WIN SOURCE:

- ⊖ [View EE-SX3161-W11 on WIN SOURCE](#)
- ⊖ [Omron Information](#)

## Optimize Your Supply Chain with WIN SOURCE Solutions

- ✓ Global Sourcing Solution
- ✓ Obsolete Management
- ✓ Cost Control Management
- ✓ Shortage Management
- ✓ Alternative Solution
- ✓ Excess Inventory Management