



**THE DATASHEET OF
EVAL-AD2S1205SDZ**



Evaluation Board for the AD2S1200/AD2S1205 Resolver-to-Digital Converters

FEATURES

Full-featured evaluation board for the [AD2S1200](#) and [AD2S1205](#)

On-board excitation buffer

On-board power supplies

Standalone capability

PC control in conjunction with system demonstration platform ([EVAL-SDP-CB1Z](#))

PC software for control and data analysis

EVALUATION BOARD DESCRIPTION

The [EVAL-AD2S1200/05SDZ](#) is a full-featured evaluation board designed to allow the user to easily evaluate all features of the [AD2S1200](#) and the [AD2S1205](#) resolver-to-digital converters. To evaluate the [AD2S1200](#), order the [EVAL-AD2S1200SDZ](#), and to evaluate the [AD2S1205](#), order the [EVAL-AD2S1205SDZ](#) (see Table 7). The evaluation board can be controlled via the SDP connector (J2). The SDP board allows the evaluation board to be controlled through the USB port of a PC using the [EVAL-AD2S1200/05SDZ](#) software.

On-board components include: the [AD8664](#) precision rail-to-rail quad op amp, the [ADP1621](#) current mode step-up converter, the

[ADM1185](#) 4-channel voltage monitor and sequencer, the [ADP3303](#) high accuracy 200 mA low dropout linear regulator, the [ADP2301](#) step-down switching regulator, the [ADP190](#) high-side power switch, the [ADM811](#) voltage supervisory device, and the [ADG3304](#) and [ADG3308](#) bidirectional logic level translators.

The evaluation board features a high current driver with user configurable gain that amplifies and biases the excitation outputs, which allows the evaluation board to be connected directly to a resolver. This high current driver circuit is described in detail in Circuit Note [CN-0192](#), available from Analog Devices, Inc.

EVAL-AD2S1200/05SDZ CONTENTS

Evaluation board hardware

Evaluation software CD for the [AD2S1200/AD2S1205](#)

Mains power supply adapter

ADDITIONAL EQUIPMENT NEEDED

System demonstration platform ([EVAL-SDP-CB1Z](#)) when using evaluation software

Resolver or resolver simulator

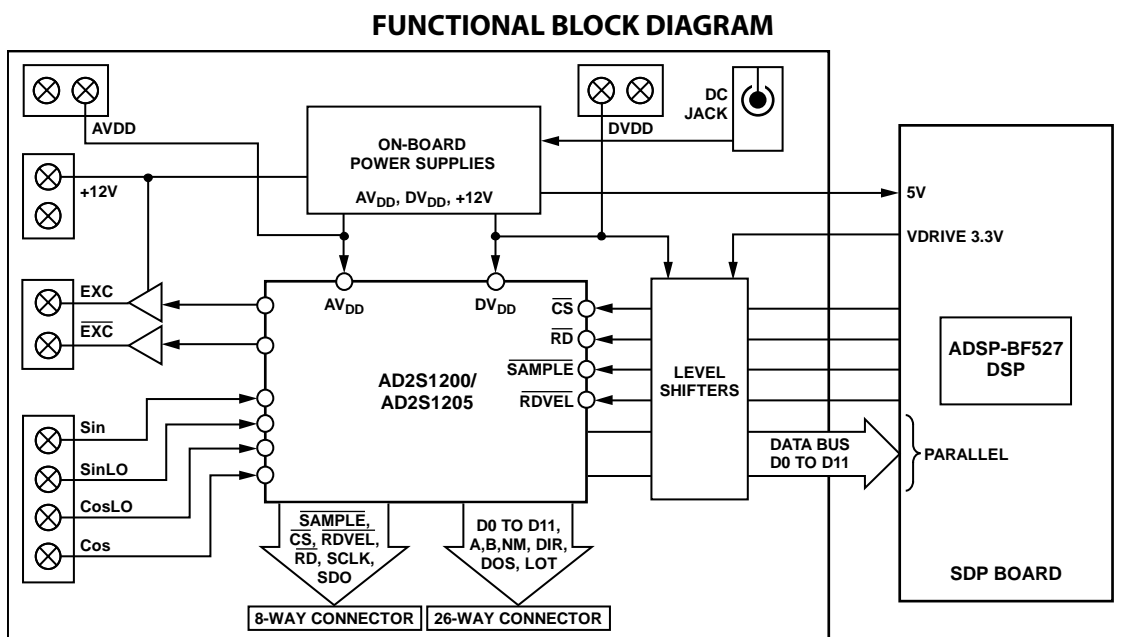

Figure 1. [EVAL-AD2S1200/05SDZ](#) Block Diagram

10442-001

TABLE OF CONTENTS

Features 1

Evaluation Board Description..... 1

EVAL-AD2S1200/05SDZ Contents 1

Additional Equipment Needed..... 1

Functional Block Diagram 1

Revision History 2

EVAL-AD2S1200/05SDZ Quickstart Guide 3

Evaluation Board Hardware 4

 Device Description..... 4

 Hardware Link Options..... 4

 Power Supplies 4

 Parallel/Serial Interface..... 6

 Sockets/Connectors..... 6

REVISION HISTORY

3/12—Rev. C to Rev. D

Document Title, Format, and Content Changed from EVAL-AD2S1200/AD2S1205, Rev. C, to UG-365, Rev. D Universal

6/07—Rev. B to Rev. C

Updated Format..... Universal

Replaced Introduction 1

Changes to Evaluation Board Interfacing Section 5

Changes to Bill of Materials 15

Test Points6

Encoder.....6

Fault Detection6

EVAL-AD2S1200/05SDZ Basic Hardware Setup.....7

Evaluation Board Software.....8

 Software Installation8

 Launching the Software..... 10

 Description of Main Software Window 12

 Data Capture..... 13

 Save File 14

 Flash LED 12

Evaluation Board Schematics and Artwork..... 15

Ordering Information..... 23

11/06—Rev. A to Rev. B

Added EVAL-AD2S1205 Universal

11/05—Rev. 0 to Rev. A

Added Evaluation Board Schematics and Artwork..... 10

Added Bill of Materials 14

5/04—Revision 0: Initial Version

EVAL-AD2S1200/05SDZ QUICKSTART GUIDE

Follow these steps to quickly evaluate the [AD2S1200](#) or the [AD2S1205](#):

1. Install the [EVAL-AD2S1200/05SDZ](#) software from the enclosed CD. Ensure that the [EVAL-SDP-CB1Z](#) board is disconnected from the USB port of the PC while installing the software. The PC may need to be restarted after the installation.
2. Ensure that the default link options are configured as outlined in Table 2.
3. Connect the [EVAL-SDP-CB1Z](#) board to the [EVAL-AD2S1200/05SDZ](#) board as shown in Figure 2.
4. Screw the two boards together with the enclosed nylon screw-nut set to ensure that the boards connect firmly together.
5. Connect the power supply adapter included in the kit to Connector J702 on the [EVAL-AD2S1200/05SDZ](#) board.
6. Connect the [EVAL-SDP-CB1Z](#) board to the PC via the USB cable. For Windows® XP, you may need to search for the [EVAL-SDP-CB1Z](#) drivers. Choose to automatically search for the drivers for the [EVAL-SDP-CB1Z](#) board if prompted by the operating system.
7. Launch the [AD2S1200_05](#) software from the **Analog Devices** subfolder in the **Programs** menu.
8. Press the **RESET** button, S1, on the [EVAL-AD2S1200/05SDZ](#) board.

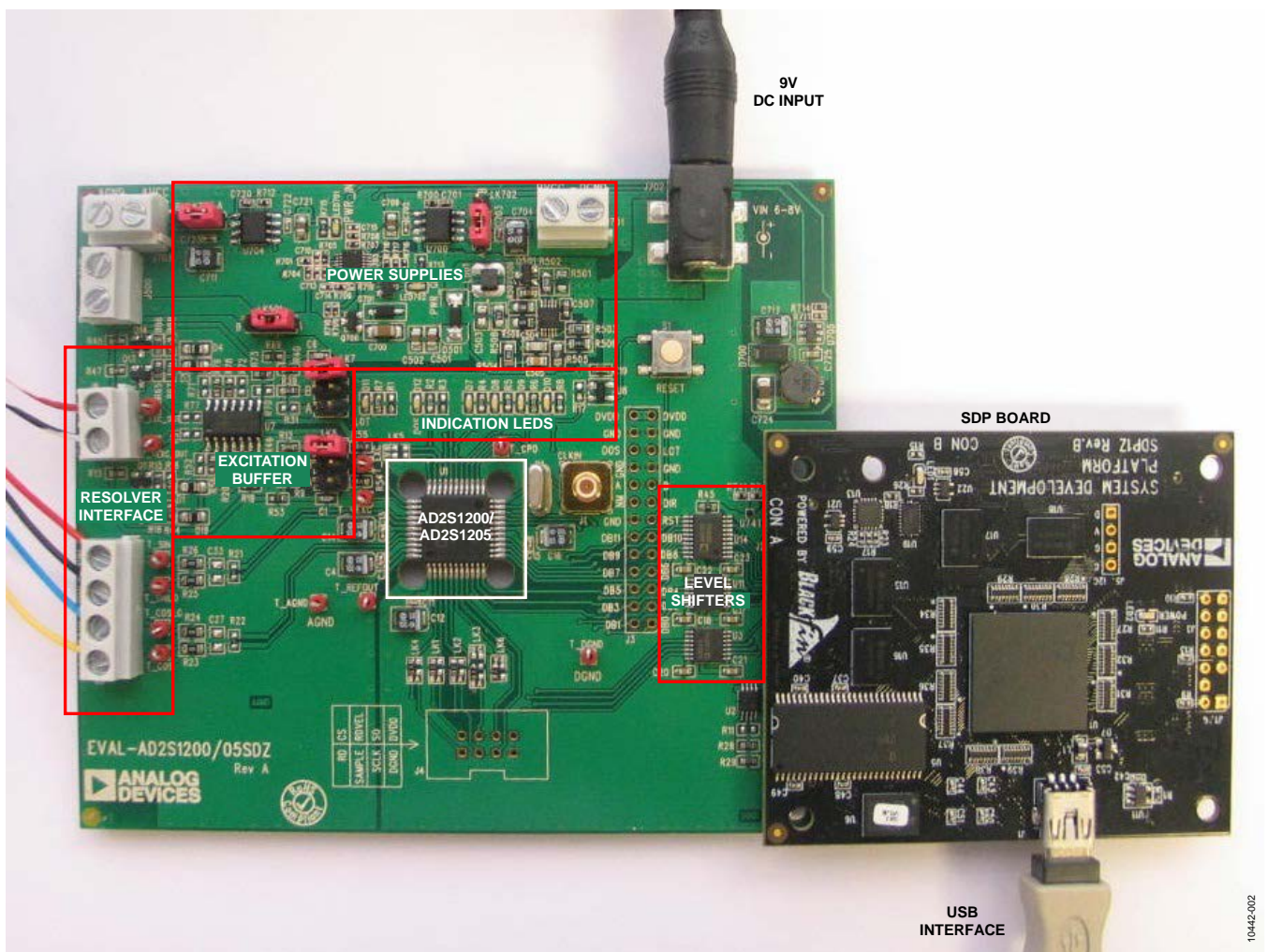

Figure 2. Hardware Configuration—Setting Up the [EVAL-AD2S1200/05SDZ](#)

EVALUATION BOARD HARDWARE

DEVICE DESCRIPTION

This user guide describes the evaluation board for the [AD2S1200](#) and the [AD2S1205](#), which are 12-bit resolution tracking resolver-to-digital converters.

The [AD2S1200](#) and the [AD2S1205](#) integrate an on-chip programmable sinusoidal oscillator that provides sine wave excitation for resolvers.

The 12-bit angular position and velocity data is accessed via either a 12-bit parallel port or a 3-wire serial interface. On-chip incremental encoder emulation with direction output is also available for positional data.

On-chip fault detection detects loss of resolver signals, out of range input signals, input signal mismatch, and loss of position tracking.

Complete specifications for the [AD2S1200](#) and the [AD2S1205](#) are provided in the [AD2S1200](#) and the [AD2S1205](#) data sheets, available from Analog Devices, which should be consulted in conjunction with this user guide when using the evaluation board. Full details on the [EVAL-SDP-CB1Z](#) are available on the Analog Devices website.

HARDWARE LINK OPTIONS

The function of the link options are described in Table 2. The default setup is configured to operate the board with the mains power supply adapter and to interface to the [EVAL-SDP-CB1Z](#) board via the parallel interface.

It is also possible to operate the board in standalone mode when interfacing to a user defined system. The evaluation board can be configured to operate in standalone serial or parallel mode by setting the necessary link options. Angular positional data can also be determined by interfacing with the encoder outputs.

POWER SUPPLIES

Care should be taken before applying power and signals to the evaluation board to ensure that all link positions are as per the required operating mode. See Table 2 for the complete list of link options.

This evaluation board comes with a wall-mountable switching power supply that provides a 9 V dc output. Connect the supply to a 100 V to 240 V ac wall outlet at 50 Hz to 60 Hz. The output from the supply is provided through a 2.0 mm inner diameter jack that connects to the evaluation board at J702. The 9 V supply is connected to the various on-board power management devices that supply the correct bias to each of the various sections on the board and the [EVAL-SDP-CB1Z](#) board.

When using this evaluation board with the [EVAL-SDP-CB1Z](#) board, it is necessary to power the board through the J702 connector. The V_{CCY} for the [ADG3304](#) and [ADG3308](#) level translator devices are sourced from the [EVAL-SDP-CB1Z](#) board.

In standalone configuration, it is possible to power the evaluation board through external power supplies via the relevant screw terminal connectors.

If the evaluation board is used without the 9 V adapter, 5 V must be connected to the AVDD input to supply the [AD2S1200/AD2S1205](#) AV_{DD} pin. In addition, 5 V must be connected to the DVDD input to supply the [AD2S1200/AD2S1205](#) DV_{DD} pin. 12 V must be connected to the +12 V connector to supply the excitation buffer circuitry.

Each supply is decoupled on this board using 10 μ F tantalum and 10 nF multilayer ceramic capacitors.

Extensive ground planes are used on this board to minimize the effect of high frequency noise interference. There are two main ground planes, AGND and DGND. These are connected at one location close to the [AD2S1200/AD2S1205](#).

Table 1. External Power Supply Required

Power Supply	Voltage Range	Purpose
VIN	9 V \pm 5%	Supplies power to on-board power management devices
AVDD	5 V \pm 5%	RDC analog supply rail
DVDD	5 V \pm 5%	RDC digital supply rail
12 V	9 V to 15 V	Excitation buffer supply

Table 2. Link Options

Category	Link	Default Position	Function
Interface	LK1	B	This link selects the source of the \overline{CS} input signal for the AD2S1200/AD2S1205 . In Position A, the \overline{CS} signal is taken from the externally applied signal via the J4 connector. In Position B, the \overline{CS} signal is taken from the SDP board via the 120-way connector.
	LK2	B	This link selects the source of the \overline{SAMPLE} input signal for the AD2S1200/AD2S1205 . In Position A, the \overline{SAMPLE} signal is taken from the externally applied signal via the J4 connector. In Position B, the \overline{SAMPLE} signal is taken from the SDP board via the 120-way connector.
	LK3	B	This link selects the source of the \overline{RDVEL} input signal for the AD2S1200/AD2S1205 . In Position A, the \overline{RDVEL} signal is taken from the externally applied signal via the J4 connector. In Position B, the \overline{RDVEL} signal is taken from the SDP board via the 120-way connector. In Position C, the \overline{RDVEL} signal is tied to DVDD. In Position D, the \overline{RDVEL} signal is tied to DGND.
	LK4	B	This link selects the source of the \overline{RD} input signal for the AD2S1200/AD2S1205 . In Position A, the \overline{RD} signal is taken from the externally applied signal via the J4 connector. In Position B, the \overline{RD} signal is taken from the SDP board via the 120-way connector.
	LK6	A	This link selects the source of the \overline{SOE} input signal for the AD2S1200/AD2S1205 . In Position A, the \overline{SOE} signal is tied to DVDD (parallel mode). In Position B, the \overline{SOE} signal is tied to DGND (serial mode).
Frequency Selection	LK5	Not inserted (10 kHz)	This link selects the frequency of the sinusoidal excitation signals, the EXC and \overline{EXC} pins of AD2S1200/AD2S1205 . The frequency of this reference signal is programmable to four standard frequencies (10 kHz, 12 kHz, 15 kHz, or 20 kHz) using the FS1 and FS2 pins. FS1 and FS2 have internal pull-ups. In Position A, the FS2 signal is tied to AGND. In Position B, the FS1 signal is tied to AGND.
Buffer Gain	LK7, LK8	C	These links select the gain of the EXC and \overline{EXC} amplifier circuits. In Position A, the gain can be set by the user. Gain = $R/10\text{ k}\Omega$, where $R = R31 = R9$. In Position B, a gain of 1.54 is applied. In Position C, a gain of 0.866 is applied.
Power Supplies	LK501	A	This link is used to select the source of the +12 V supply for the EVAL-AD2S1200/05SDZ . In Position A, the +12 V supply is sourced internally from the on-board power supplies. In Position B, the +12 V supply is sourced externally via the J500 connector.
	LK701	A	This link is used to select the source of the AVDD supply for the EVAL-AD2S1200/05SDZ . In Position A, the AVDD supply is sourced internally from the on-board power supplies. In Position B, the AVDD supply is sourced externally via the J703 connector.
	LK702	A	This link is used to select the source of the DVDD supply for the EVAL-AD2S1200/05SDZ . In Position A, the DVDD supply is sourced internally from the on-board power supplies. In Position B, the DVDD supply is sourced externally via the J701 connector.

PARALLEL/SERIAL INTERFACE

In the default configuration, information is transferred to the [EVAL-SDP-CB1Z](#) via the parallel interface.

SOCKETS/CONNECTORS

There is one SMB input socket, J1, on this evaluation board. This socket allows external clock frequencies to be applied to the [EVAL-AD2S1200/05SDZ](#) board. The on-board 8.192 MHz crystal should be removed if an external clock is used.

There are nine connectors on the [EVAL-AD2S1200/05SDZ](#) board, as outlined in Table 3.

Table 3. On-Board Connectors

Connector	Function
J2	120-way connector for EVAL-SDP-CB1Z interface
J3	External 26-way connector for parallel operation
J4	External 8-way connector for serial operation
J5	Connector for SIN, SINLo, COS, and COSLo inputs
J6	Connector for EXC and $\overline{\text{EXC}}$ outputs
J500	External 12 V and AGND power connector
J701	External DVDD and DGND power connector
J702	9 V, 2.0 mm dc jack connector
J703	External AVDD and AGND power connector

The default interface to this evaluation board is via the 120-way connector, which connects the [EVAL-AD2S1200/05SDZ](#) to the [EVAL-SDP-CB1Z](#) board.

Additional options for interfacing with the evaluation board are via J3, a 26-way connector, or via J4, an 8-way connector. These connectors are provided to allow the evaluation board to be interfaced with systems other than the Analog Devices [EVAL-SDP-CB1Z](#) board. The 26-way connector, J3, is provided for use in parallel mode. The 8-way connector, J4, is provided for use in serial mode. The pin designations for both connectors are shown in Table 4 and Table 5, respectively.

TEST POINTS

There are numerous test points on the [EVAL-AD2S1200/05SDZ](#) board. These test points enable the user to have easy access to the signals from the evaluation board, the external sensor, and the controller board for probing, evaluation, and debugging.

Table 4. Pin Designations for 26-Way Connector J3

Pin No.	Row A	Row B
1	DB0	DB1
2	DB2	DB3
3	DB4	DB5
4	DB6	DB7
5	DB8	DB9
6	DB10	DB11
7	RST	DGND
8	DIR	NM
9	B	A
10	DGND	DGND
11	LOT	DOS
12	DGND	DGND
13	DVDD	DVDD

Table 5. Pin Designations for 8-Way Connector J4

Pin No.	Row A	Row B
1	$\overline{\text{RD}}$	$\overline{\text{CS}}$
2	$\overline{\text{SAMPLE}}$	$\overline{\text{RDVEL}}$
3	SCLK	SO
4	DGND	DVDD

ENCODER

The [AD2S1200](#) and [AD2S1205](#) emulate a 1024-line encoder and a DIR direction output pin. These outputs allow the angular position to be determined without the need for parallel or serial communication interfaces. For ease of analysis, these outputs are wired to on-board LEDs on the [EVAL-AD2S1200/05SDZ](#) board. The status of these outputs can also be monitored via the J3 connector. See Table 4 for the connector pinout.

FAULT DETECTION

The [AD2S1200](#) and [AD2S1205](#) devices contain on-chip fault detection. The fault status is flagged via the LOT and DOS output pins. For ease of analysis, these outputs are wired to on-board LEDs on the [EVAL-AD2S1200/05SDZ](#) board. The status of these outputs can also be monitored via the J3 connector. See Table 4 for the connector pinout.

EVAL-AD2S1200/05SDZ BASIC HARDWARE SETUP

The EVAL-AD2S1200/05SDZ board connects to the EVAL-SDP-CB1Z system demonstration platform board. The EVAL-SDP-CB1Z board is the controller board, which is the communication link between the PC and the main evaluation board. Figure 2 shows a photograph of the connections made between the EVAL-AD2S1200/05SDZ daughter board and the EVAL-SDP-CB1Z board.

A resolver or resolver simulator should be connected to the EVAL-AD2S1200/05SDZ board as outlined in Table 6. The primary windings, R1 and R2, are connected to the buffered excitation outputs from the evaluation board. The resolver stator outputs should be connected to the corresponding EVAL-AD2S1200/05SDZ board inputs.

Table 6. Typical Resolver Connection

Resolver	Name	EVAL-AD2S1200/05SDZ	
		Pin	Connector
R1	EXE	2	J6
R2	$\overline{\text{EXE}}$	1	
S1	SIN	4	J5
S2	COS	1	
S3	SINLO	3	
S4	COSLO	2	

The gain stage for the excitation buffer can be controlled via Link LK7 and Link LK8. These should be configured to provide the necessary gain to allow the resolver inputs to lie within the required specification. See Table 2 for the link options.

Before connecting power, connect the EVAL-AD2S1200/05SDZ board to Connector A on the EVAL-SDP-CB1Z board. Nylon screws are included in the EVAL-AD2S1200/05SDZ kit and can be used to ensure that the EVAL-AD2S1200/05SDZ and EVAL-SDP-CB1Z boards are connected firmly together.

After the EVAL-AD2S1200/05SDZ board and the EVAL-SDP-CB1Z board are connected securely, connect the power to the EVAL-AD2S1200/05SDZ board. The EVAL-AD2S1200/05SDZ board requires an external power supply adapter, which is included in the evaluation board kit. Connect this power supply to Connector J702 on the EVAL-AD2S1200/05SDZ board. For further details on the required power supply connections and options, see the Power Supplies section.

Before connecting the EVAL-SDP-CB1Z board to your PC, ensure that the EVAL-AD2S1200/05SDZ software has been installed from the enclosed CD. The full software installation procedure is detailed in the Evaluation Board Software section.

Finally, connect the EVAL-SDP-CB1Z board to the PC via the USB cable enclosed in the EVAL-SDP-CB1Z kit. If using a Windows XP platform, you may need to search for the EVAL-SDP-CB1Z drivers. Choose to automatically search for the drivers for the EVAL-SDP-CB1Z board if prompted by the operating system.

EVALUATION BOARD SOFTWARE SOFTWARE INSTALLATION

The [EVAL-AD2S1200/05SDZ](#) kit includes software on a CD. Click the **setup.exe** file from the CD to run the install. The default location for the software is

C:\Program Files\Analog Devices\AD2S1200_05\

Install the evaluation software before connecting the evaluation board and [EVAL-SDP-CB1Z](#) board to the USB port of the PC to ensure that the evaluation system is correctly recognized when connected to the PC.

There are two parts to the installation:

- [EVAL-AD2S1200/05SDZ](#) board software installation
- [EVAL-SDP-CB1Z](#) system demonstration platform board drivers installation

Follow Step 1 to Step 5 (see Figure 3 to Figure 7) to install the [EVAL-AD2S1200/05SDZ](#) software. Follow Step 6 to Step 9 (see Figure 8 to Figure 11) to install the [EVAL-SDP-CB1Z](#) drivers. Proceed through all of the installation steps, allowing the software and drivers to be placed in the appropriate locations. Connect the [EVAL-SDP-CB1Z](#) board to the PC only after the software and drivers have been installed.

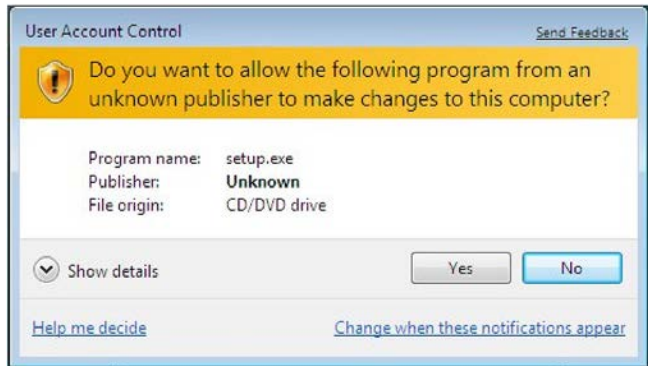

Figure 3. [EVAL-AD2S1200/05SDZ](#) Installation—User Account Control

1. Click **Yes** to begin the installation process.

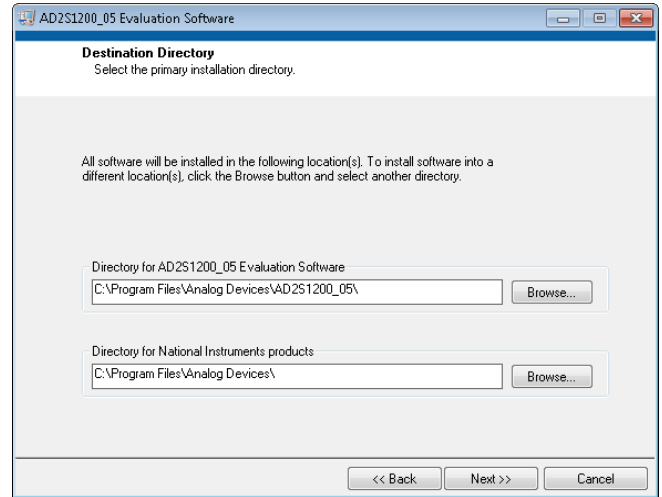

Figure 4. [EVAL-AD2S1200/05SDZ](#) Installation—Destination Directory

2. Select the installation directory. Click **Next**.

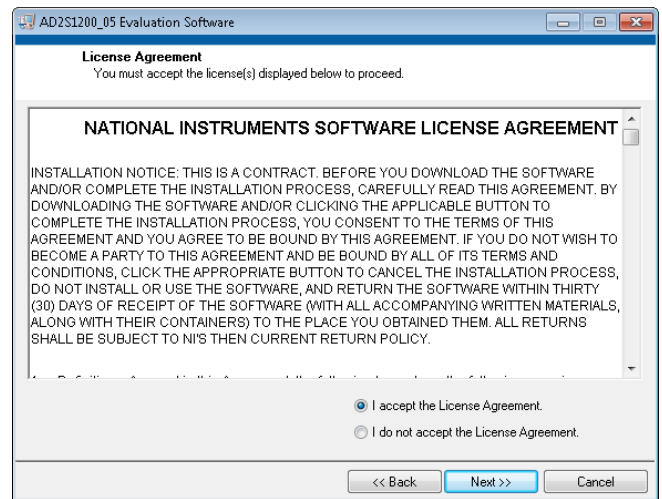

Figure 5. [EVAL-AD2S1200/05SDZ](#) Installation—License Agreement

3. Click **I accept the License Agreement**, and click **Next**.

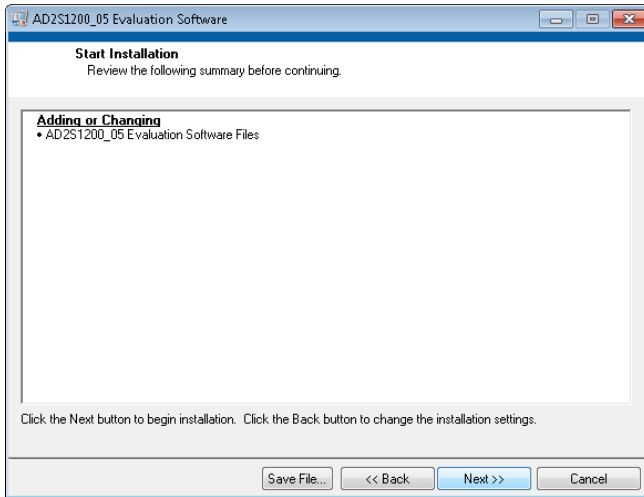

Figure 6. EVAL-AD2S1200/05SDZ Installation—Start Installation

4. Click **Next** to install the software.

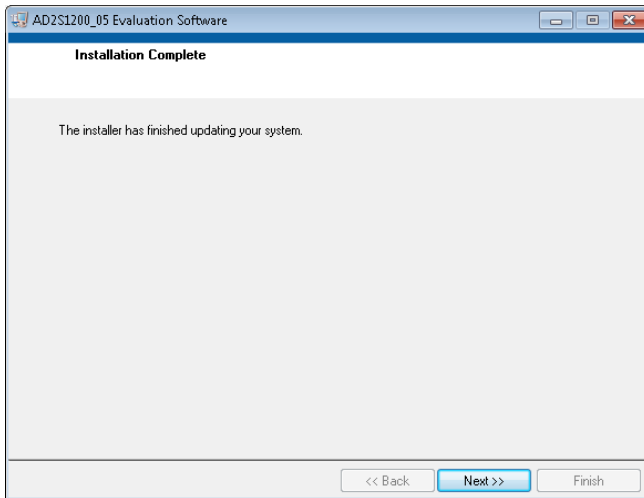

Figure 7. EVAL-AD2S1200/05SDZ Installation—Installation Complete

5. The installation of the evaluation software completes. Click **Next** to proceed with the installation of the drivers.



Figure 8. EVAL-SDP-CB1Z Drivers Installation—Setup Wizard

6. The setup wizard opens. Click **Next** to begin the driver installation process.

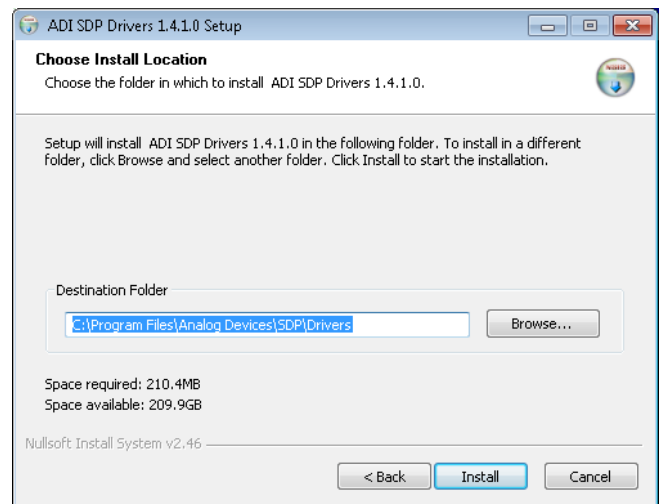

Figure 9. EVAL-SDP-CB1Z Drivers Installation—Choose Install Location

7. Select a destination folder for the SDP drivers, and click **Install**.

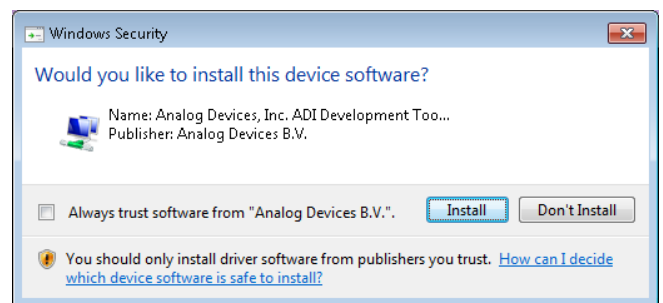

Figure 10. EVAL-SDP-CB1Z Drivers Installation—Windows Security

8. Click **Install** to proceed with the installation.

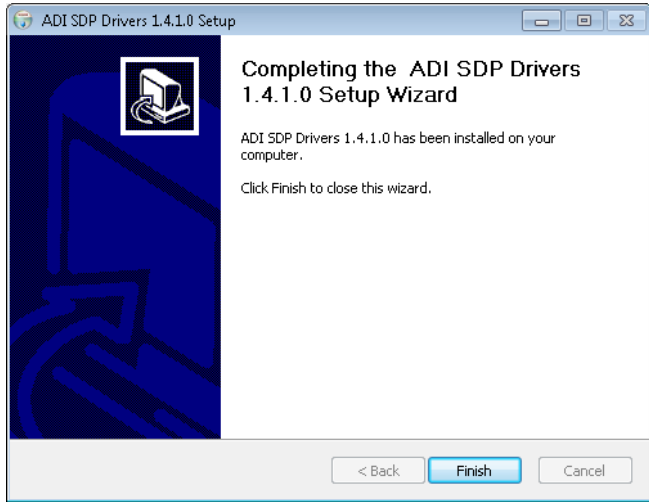

Figure 11. EVAL-SDP-CB1Z Drivers Installation—Complete

9. Click **Finish**.

After installation from the CD is complete, connect the **EVAL-AD2S1200/05SDZ** board to the **EVAL-SDP-CB1Z** board as described in the Evaluation Board Hardware section.

When you first plug in the **EVAL-SDP-CB1Z** board via the USB cable provided, allow the **Found Hardware Wizard** to run. After the drivers are installed, you can check that the board is connected correctly by looking at the **Device Manager** of the PC. The **Device Manager** can be found by right-clicking **My Computer** > **Manage** > **Device Manager** from the list of **System Tools**, as shown in Figure 12. The **EVAL-SDP-CB1Z** SDP-B board should appear under **ADI Development Tools**. This completes the installation.

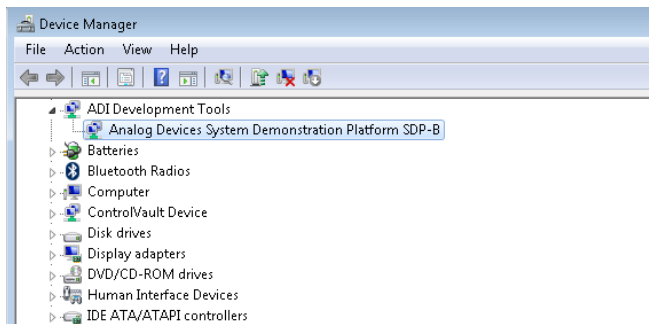

Figure 12. Device Manager

LAUNCHING THE SOFTWARE

After the **EVAL-AD2S1200/05SDZ** and **EVAL-SDP-CB1Z** boards are correctly connected to your PC, the **EVAL-AD2S1200/05SDZ** software can be launched.

To launch the software, perform the following steps:

1. From the **Start** menu, select **Programs** > **Analog Devices** > **AD2S1200_05**. The main window of the software then opens (see Figure 14).
2. If the **EVAL-AD2S1200/05SDZ** board is not connected to the USB port via the **EVAL-SDP-CB1Z** when the software is launched, a connectivity error displays (see Figure 13). Connect the evaluation board to the USB port of the PC, wait a few seconds, click **Rescan**, and follow the instructions.

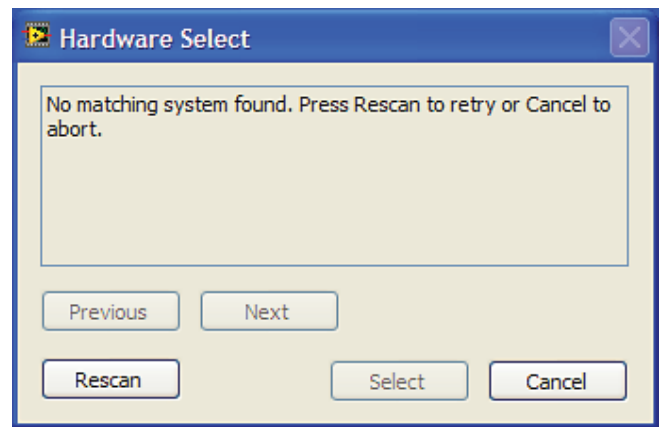
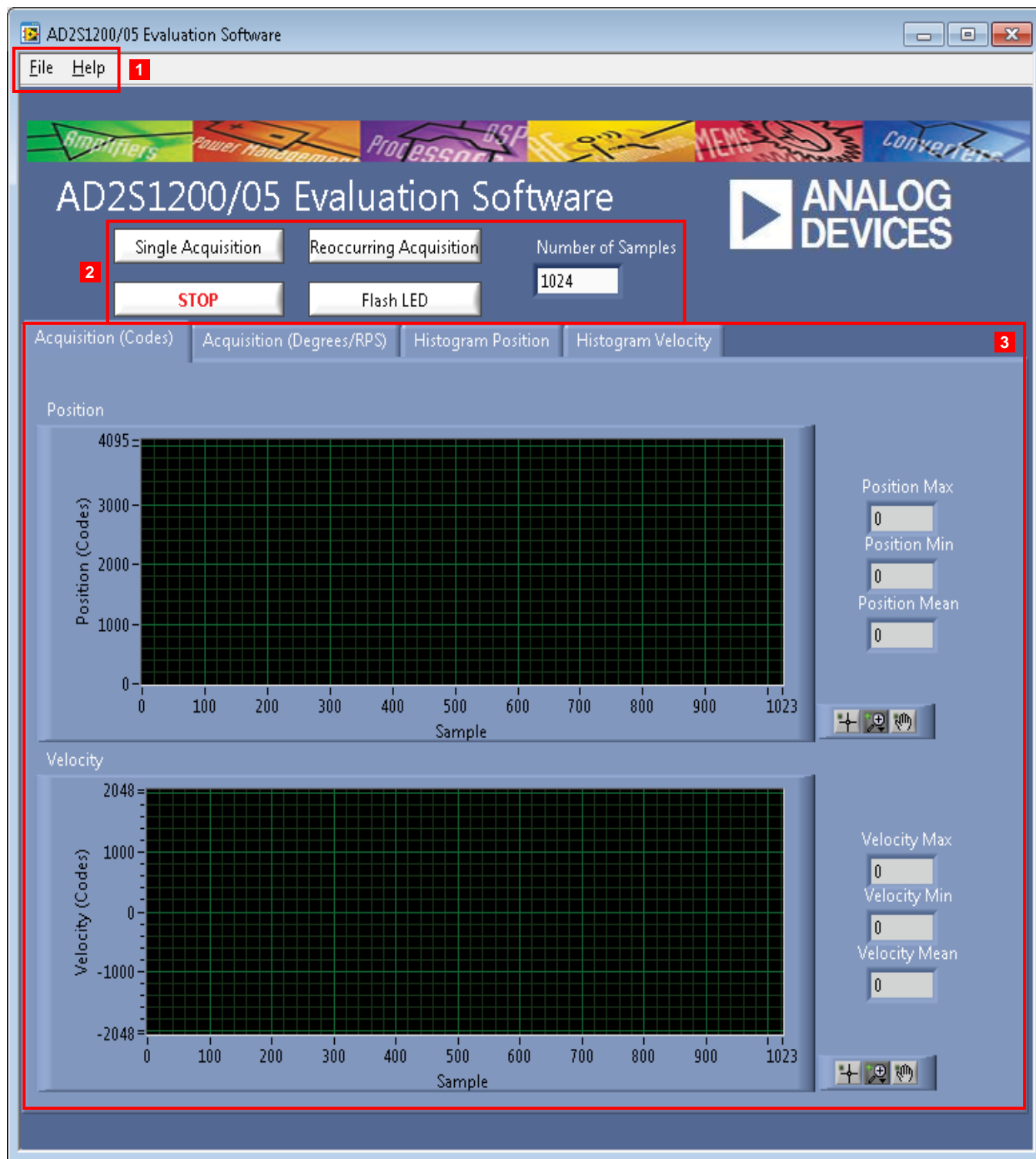

Figure 13. Connectivity Error Alert



- 1. MENU BAR.
- 2. CONTROL BUTTONS.
- 3. DATA CAPTURE DISPLAY.

Figure 14. Evaluation Software Main Window

1042_014

DESCRIPTION OF MAIN SOFTWARE WINDOW

When the software is launched, the main software window opens (see Figure 14).

The user software panel as shown in Figure 14 has the following features:

- Menu bar
- Control buttons
- Data capture display

Menu Bar

The menu bar consists of the **File** and **Help** menus.

File Menu

Save Data (Acquisition). Saves the position, velocity, and fault data of a defined number of samples in normal mode into a spreadsheet file.

Print Front Panel. Prints the software window displayed.

Save as Picture. Saves the front panel as a JPEG file.

Exit. Exits the program.

Help Menu

Analog.com. Opens www.analog.com.

Control Buttons

The [EVAL-AD2S1200/05SDZ](#) software includes the following control buttons, drop-down boxes, and indicators.

Single Acquisition. Initiates the sampling and readback of the defined number of resolver-to-digital converter (RDC) measurements.

STOP. Stops the program.

Reoccurring Acquisition. Repeats single acquisition until the button is released (normal mode).

Flash LED. Causes the orange **LED1A** on the SDP board to flash, which can be a useful debugging tool.

Number of Samples. Selects the number of samples to be completed in a single acquisition.

ON/OFF. Enables or disables the histogram option. (This button appears on the **Histogram Position** and **Histogram Velocity** tabs only.)

Data Capture Display

In the data capture display, you can select the format in which to view the position and velocity conversion results. The position data can be displayed in digital output code format or in degrees. The velocity data can be displayed in digital output code format or in rotations per second (RPS). The desired display options are selected by clicking on the **Acquisition (Codes)**, **Acquisition (Degrees/RPS)**, **Histogram Position**, and **Histogram Velocity** tabs.

Acquisition (Codes) Tab

The **Acquisition (Codes)** tab displays the conversion results taken in normal mode of the position and velocity of the resolver connected to the [EVAL-AD2S1200/05SDZ](#) board. The number of conversions results displayed is defined by the **Number of Samples** box. The conversion results are displayed as waveforms in digital code on two graphs. The upper graph displays the position conversion results. The lower graph displays the velocity conversion results. The maximum, minimum, and mean values of the sample set are displayed on indicators to the right of each graph.

At the bottom right of each graph are the zoom options. These allow you to zoom in and out to obtain a closer look at a sample if required.

Acquisition (Degrees/RPS) Tab

The **Acquisition (Degrees/RPS)** tab displays the conversion results taken in normal mode of the position and velocity of the resolver connected to the [EVAL-AD2S1200/05SDZ](#) board. The number of conversions results displayed is defined by the **Number of Samples** box. The position conversion result is displayed in degrees on the upper graph. The lower graph displays the velocity conversion results in RPS. The maximum, minimum, and mean values of the sample set are displayed on indicators to the right of each graph.

At the bottom right of each graph are the zoom options. These allow you to zoom in and out to obtain a closer look at a sample if required.

Histogram Position Tab

The **Histogram Position** tab displays the histogram of the position conversion results taken in normal mode of the resolver connected to the [EVAL-AD2S1200/05SDZ](#) board. To enable this option, you must set the **ON/OFF** button to the on position. The histogram is displayed only when the output code varies for the one block of samples; that is, if the same conversion result is returned for all samples, the histogram is not displayed.

At the bottom right of each graph are the zoom options. These allow you to zoom in and out to obtain a closer look at a sample if required.

Histogram Velocity Tab

The **Histogram Velocity** tab displays the histogram of the velocity conversion results taken in normal mode of the resolver connected to the [EVAL-AD2S1200/05SDZ](#) board. To enable this option, you must set the **ON/OFF** button to the on position. The histogram is displayed only when the output code varies for the one block of samples; that is, if the same conversion result is returned for all samples, the histogram is not displayed.

Within any of the chart panels, the tools shown in Figure 15 allow user control of the different chart displays.

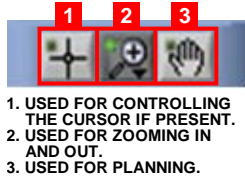

Figure 15. Chart Tools

DATA CAPTURE

To initiate conversions and to capture the sample data, you must click the **Single Acquisition** or the **Reoccurring Acquisition** button.

When the **Single Acquisition** button is clicked, the software instructs the EVAL-SDP-CB1Z to read back the conversion results from the EVAL-AD2S1200/05SDZ board. The number of samples is selected via the **Number of Samples** box. After each conversion, data from the AD2S120x is written to external memory on the EVAL-SDP-CB1Z. The required set of samples is uploaded through the USB port to the PC when all conversions are completed.

When you click the **Reoccurring Acquisition** button, the software instructs the EVAL-SDP-CB1Z to read back the conversion results from the EVAL-AD2S1200/05SDZ board in a repeating loop. The number of samples is selected via the **Number of Samples** box. After each conversion, data from the AD2S120x is written to external memory on the EVAL-SDP-CB1Z. The required set of samples is uploaded through the USB port to the PC when all the conversions are completed. If the **Reoccurring Acquisition** button is not clicked again to release the loop, the conversion loop repeats. While the data is being uploaded to the PC, the AD2S120x device is not converting; therefore, there may be a time delay between two blocks of samples.

In single acquisition and reoccurring acquisition mode, the data is displayed on the data capture display. The data is displayed on the **Acquisition (Codes)**, **Acquisition (Degrees/RPS)**, **Histogram Position**, and **Histogram Velocity** tabs.

Figure 16 shows a typical data capture. Both position and velocity data results are presented in the data capture display. Additionally, the following data is displayed:

- A summary of the measured positional data
- A summary of the measured velocity data

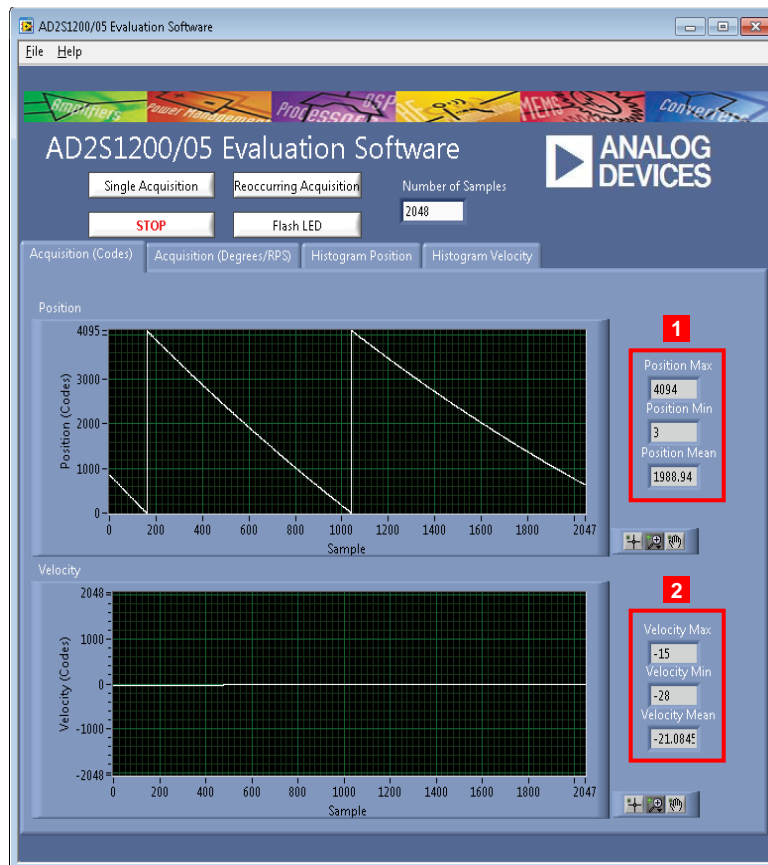

1. SUMMARY OF THE MEASURED POSITIONAL DATA.
2. SUMMARY OF THE MEASURED VELOCITY DATA.

Figure 16. Acquisition (Code) Tab—Typical Data Capture

SAVE FILE

The software can save the current captured data for future analysis.

Go to the **File** menu, and click **Save Data (Acquisition)**. The save dialog box opens. Save to an appropriate folder location.

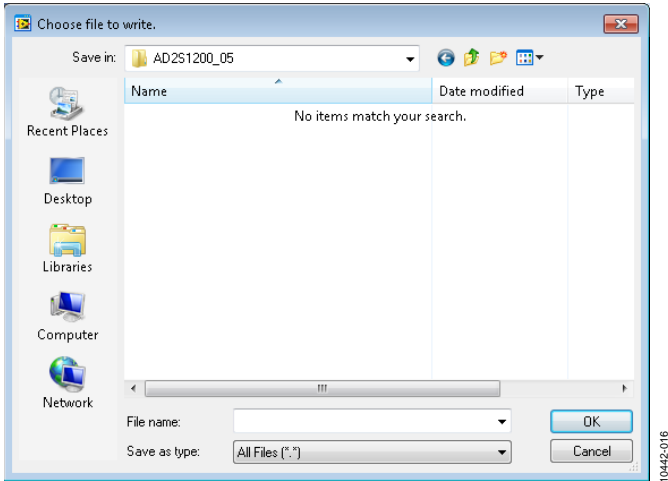

Figure 17. Save Dialog Box

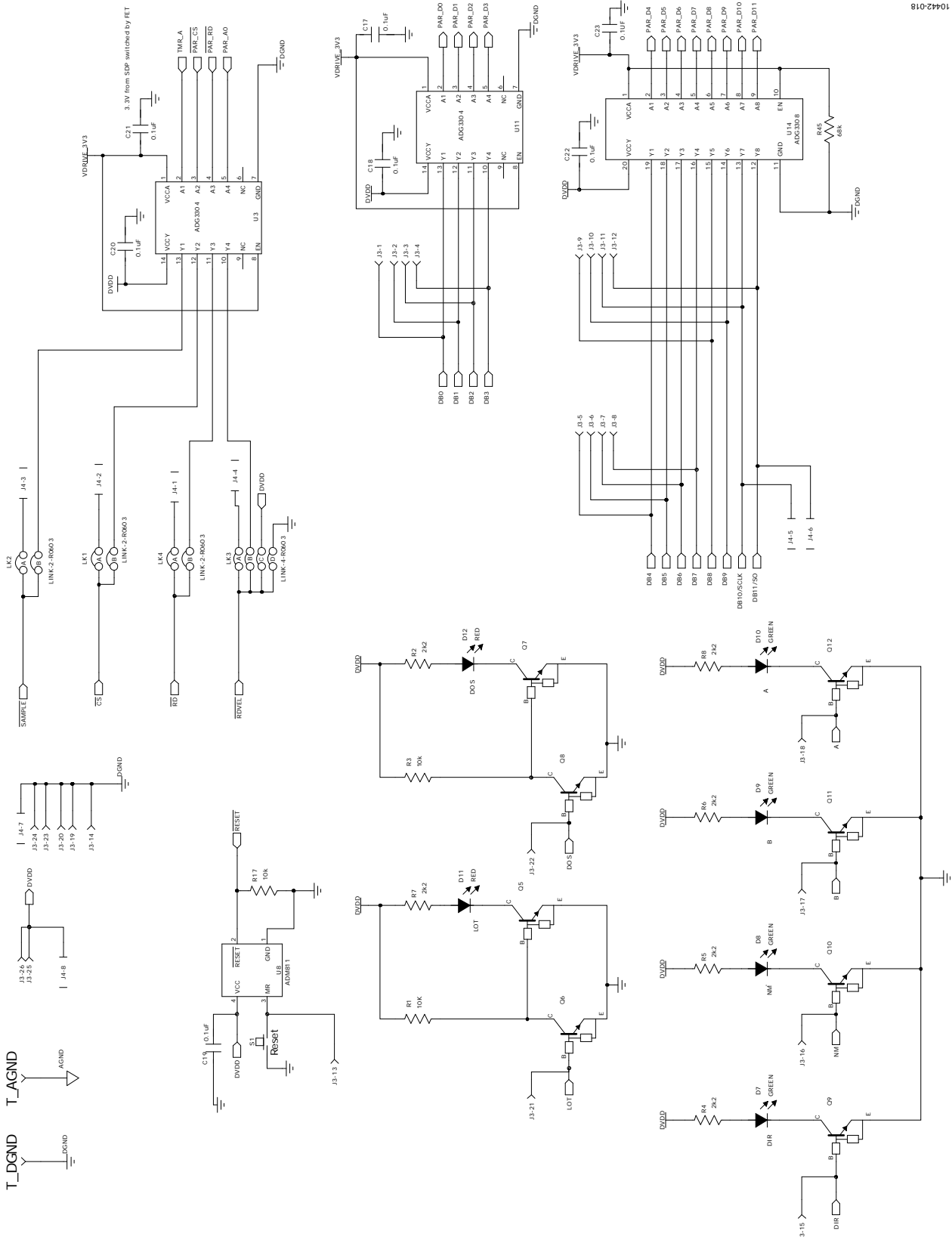

Figure 19. Schematic Page 2

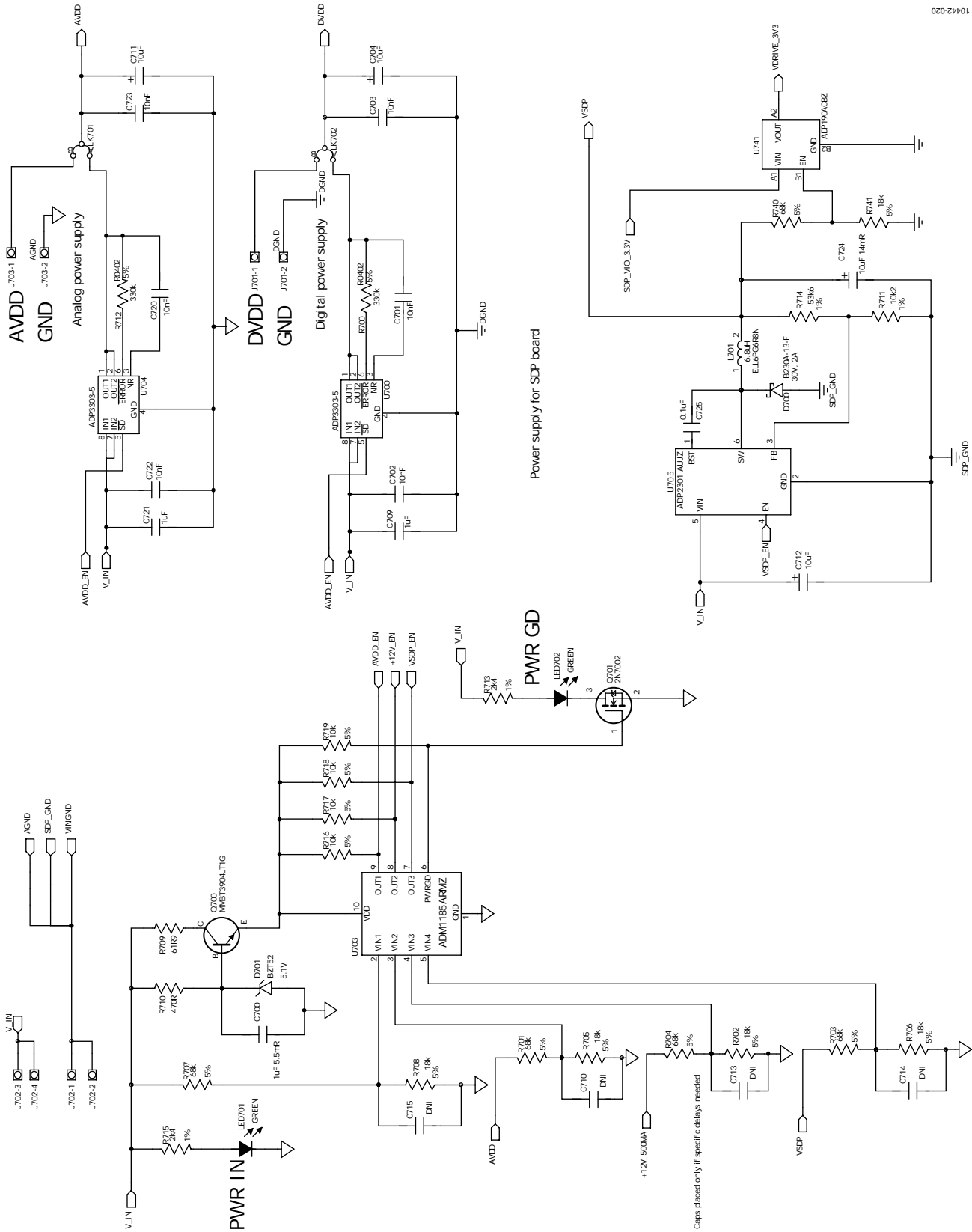

Figure 21. Schematic Page 4

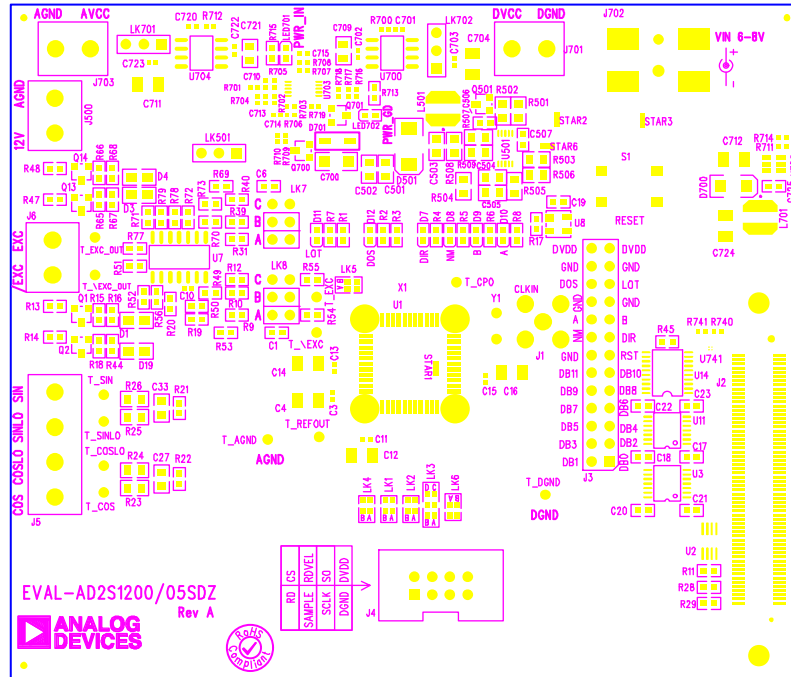

Figure 23. EVAL-AD2S1200/05SDZ Top-Side Silkscreen

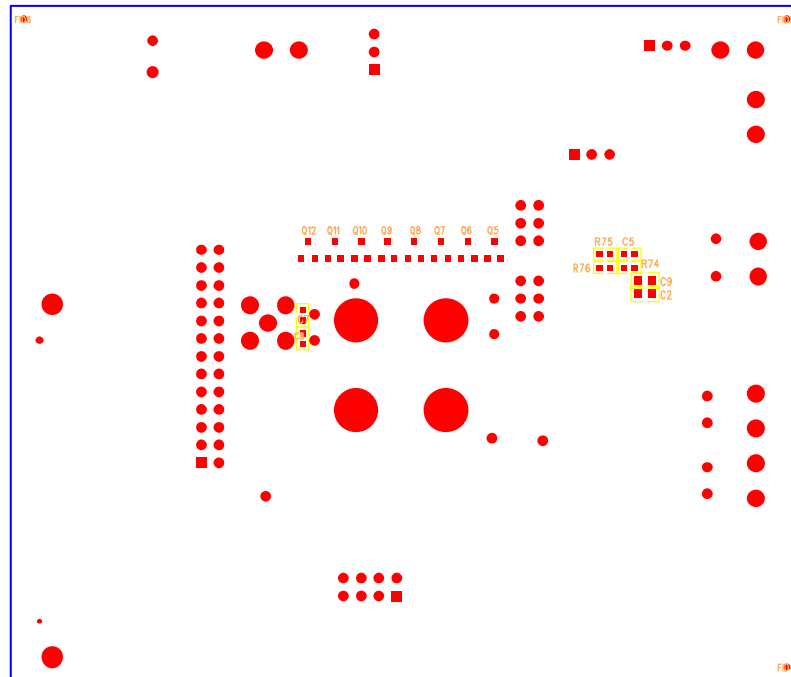

Figure 24. EVAL-AD2S1200/05SDZ Bottom-Side Silkscreen

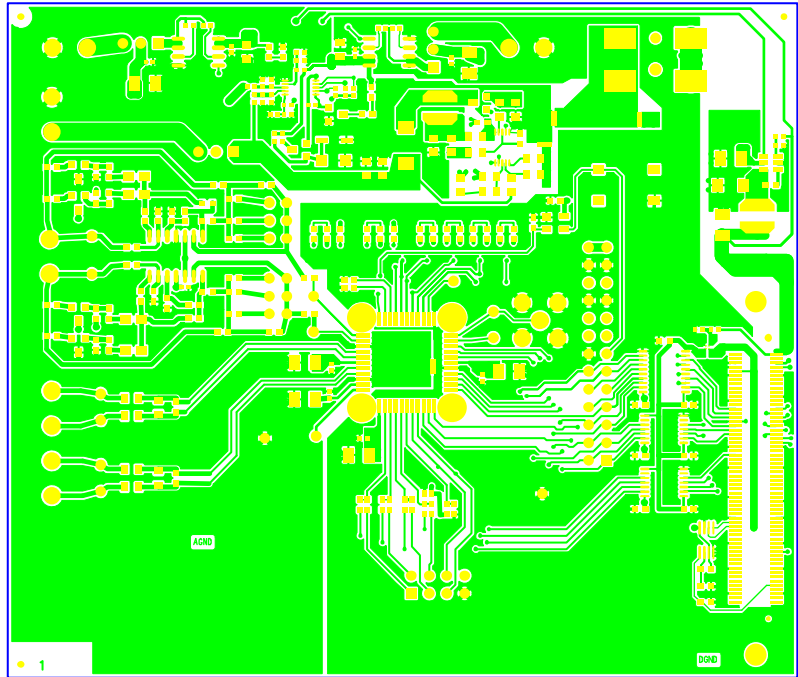

Figure 25. EVAL-AD2S1200/05SDZ Top Layer

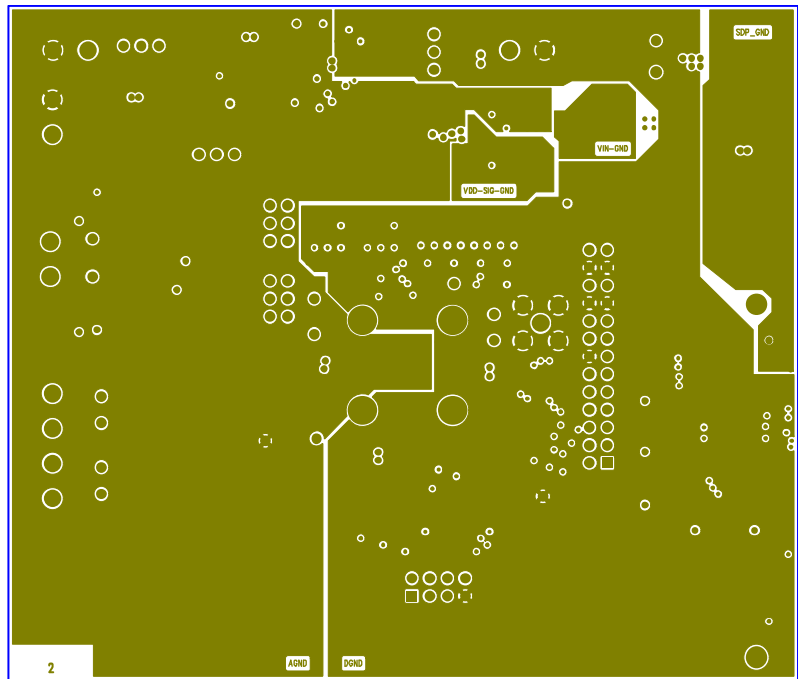

Figure 26. EVAL-AD2S1200/05SDZ Layer 2

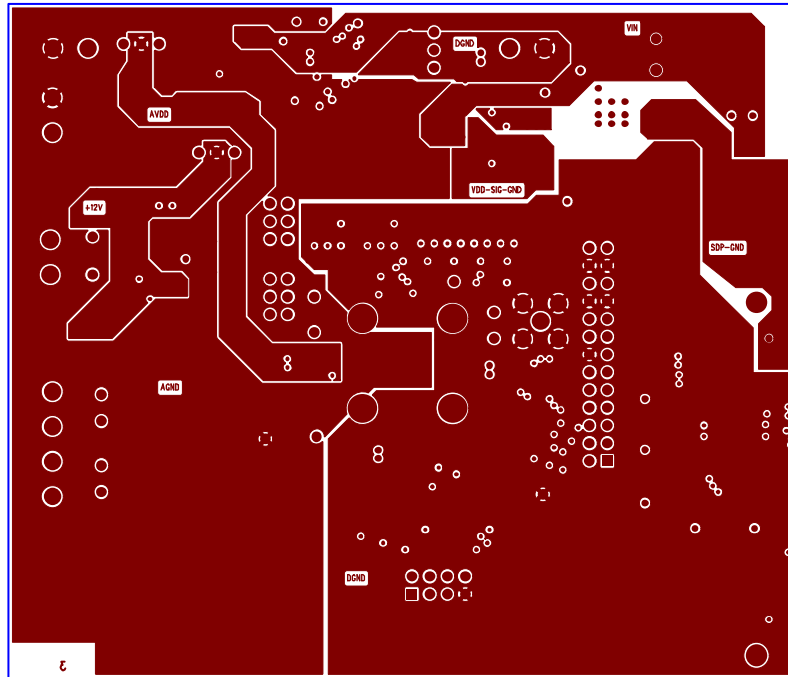

Figure 27. EVAL-AD2S1200/05SDZ Layer 3

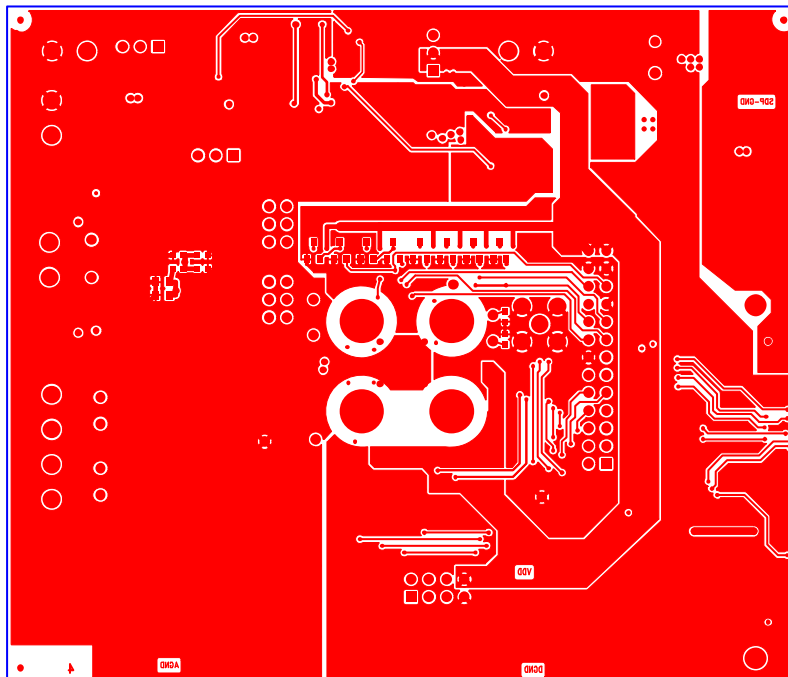

Figure 28. EVAL-AD2S1200/05SDZ Bottom Layer

ORDERING INFORMATION

See Table 7 for a list of the evaluation boards compatible with the hardware described in this user guide.

Table 7. Compatible Boards

Model¹	Description
EVAL-AD2S1200SDZ	AD2S1200 evaluation board
EVAL-AD2S1205SDZ	AD2S1205 evaluation board
EVAL-SDP-CB1Z	Evaluation controller board
ADZS-BRKOUT-EX3	Signal breakout board

¹ Z = RoHS-compliant part.

NOTES

**ESD Caution**

ESD (electrostatic discharge) sensitive device. Charged devices and circuit boards can discharge without detection. Although this product features patented or proprietary protection circuitry, damage may occur on devices subjected to high energy ESD. Therefore, proper ESD precautions should be taken to avoid performance degradation or loss of functionality.

Legal Terms and Conditions

By using the evaluation board discussed herein (together with any tools, components documentation or support materials, the "Evaluation Board"), you are agreeing to be bound by the terms and conditions set forth below ("Agreement") unless you have purchased the Evaluation Board, in which case the Analog Devices Standard Terms and Conditions of Sale shall govern. Do not use the Evaluation Board until you have read and agreed to the Agreement. Your use of the Evaluation Board shall signify your acceptance of the Agreement. This Agreement is made by and between you ("Customer") and Analog Devices, Inc. ("ADI"), with its principal place of business at One Technology Way, Norwood, MA 02062, USA. Subject to the terms and conditions of the Agreement, ADI hereby grants to Customer a free, limited, personal, temporary, non-exclusive, non-sublicensable, non-transferable license to use the Evaluation Board FOR EVALUATION PURPOSES ONLY. Customer understands and agrees that the Evaluation Board is provided for the sole and exclusive purpose referenced above, and agrees not to use the Evaluation Board for any other purpose. Furthermore, the license granted is expressly made subject to the following additional limitations: Customer shall not (i) rent, lease, display, sell, transfer, assign, sublicense, or distribute the Evaluation Board; and (ii) permit any Third Party to access the Evaluation Board. As used herein, the term "Third Party" includes any entity other than ADI, Customer, their employees, affiliates and in-house consultants. The Evaluation Board is NOT sold to Customer; all rights not expressly granted herein, including ownership of the Evaluation Board, are reserved by ADI. CONFIDENTIALITY. This Agreement and the Evaluation Board shall all be considered the confidential and proprietary information of ADI. Customer may not disclose or transfer any portion of the Evaluation Board to any other party for any reason. Upon discontinuation of use of the Evaluation Board or termination of this Agreement, Customer agrees to promptly return the Evaluation Board to ADI. ADDITIONAL RESTRICTIONS. Customer may not disassemble, decompile or reverse engineer chips on the Evaluation Board. Customer shall inform ADI of any occurred damages or any modifications or alterations it makes to the Evaluation Board, including but not limited to soldering or any other activity that affects the material content of the Evaluation Board. Modifications to the Evaluation Board must comply with applicable law, including but not limited to the RoHS Directive. TERMINATION. ADI may terminate this Agreement at any time upon giving written notice to Customer. Customer agrees to return to ADI the Evaluation Board at that time. LIMITATION OF LIABILITY. THE EVALUATION BOARD PROVIDED HEREUNDER IS PROVIDED "AS IS" AND ADI MAKES NO WARRANTIES OR REPRESENTATIONS OF ANY KIND WITH RESPECT TO IT. ADI SPECIFICALLY DISCLAIMS ANY REPRESENTATIONS, ENDORSEMENTS, GUARANTEES, OR WARRANTIES, EXPRESS OR IMPLIED, RELATED TO THE EVALUATION BOARD INCLUDING, BUT NOT LIMITED TO, THE IMPLIED WARRANTY OF MERCHANTABILITY, TITLE, FITNESS FOR A PARTICULAR PURPOSE OR NON-INFRINGEMENT OF INTELLECTUAL PROPERTY RIGHTS. IN NO EVENT WILL ADI AND ITS LICENSORS BE LIABLE FOR ANY INCIDENTAL, SPECIAL, INDIRECT, OR CONSEQUENTIAL DAMAGES RESULTING FROM CUSTOMER'S POSSESSION OR USE OF THE EVALUATION BOARD, INCLUDING BUT NOT LIMITED TO LOST PROFITS, DELAY COSTS, LABOR COSTS OR LOSS OF GOODWILL. ADI'S TOTAL LIABILITY FROM ANY AND ALL CAUSES SHALL BE LIMITED TO THE AMOUNT OF ONE HUNDRED US DOLLARS (\$100.00). EXPORT. Customer agrees that it will not directly or indirectly export the Evaluation Board to another country, and that it will comply with all applicable United States federal laws and regulations relating to exports. GOVERNING LAW. This Agreement shall be governed by and construed in accordance with the substantive laws of the Commonwealth of Massachusetts (excluding conflict of law rules). Any legal action regarding this Agreement will be heard in the state or federal courts having jurisdiction in Suffolk County, Massachusetts, and Customer hereby submits to the personal jurisdiction and venue of such courts. The United Nations Convention on Contracts for the International Sale of Goods shall not apply to this Agreement and is expressly disclaimed.

Looking for pricing, stock, or lifecycle information?

Click below to explore more details on WIN SOURCE:

- ⊖ [View EVAL-AD2S1205SDZ on WIN SOURCE](#)
- ⊖ [Analog Devices Inc. Information](#)

Optimize Your Supply Chain with WIN SOURCE Solutions

- ✓ Global Sourcing Solution
- ✓ Obsolete Management
- ✓ Cost Control Management
- ✓ Shortage Management
- ✓ Alternative Solution
- ✓ Excess Inventory Management