



**THE DATASHEET OF
TLE3303F260QG**





SERIES TL 3303 SWITCHES

TACT SWITCHES SMT - 6mm x 6mm

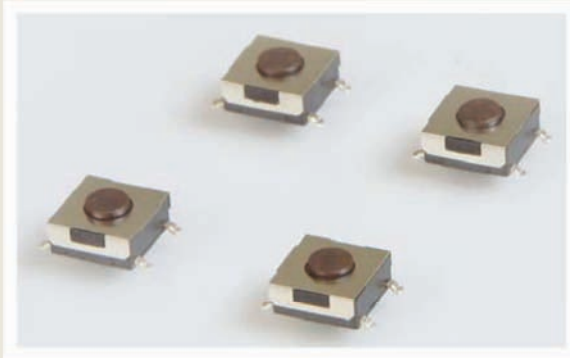

SPECIFICATIONS

Contact Rating:	50mA @ 12 VDC
Life Expectancy:	100,000 cycles typical
Contact Resistance:	100mΩ max. initial @ 2-4 VDC
Insulation Resistance:	100MΩ min.
Dielectric Strength:	250 VAC
Actuation Force:	100 ± 50 gf, 160 ± 50 gf, 260 ± 50 gf
Operating Temperature:	-20°C to 70°C
Travel:	0.25mm Typ

FEATURES & BENEFITS

- ▶ Earth ground terminal options
- ▶ Reliable dome contact technology
- ▶ Strong tactile/audible feedback

APPLICATIONS/MARKETS

- ▶ Telecommunications
- ▶ Consumer Electronics
- ▶ Audio/visual
- ▶ Medical
- ▶ Testing/instrumentation
- ▶ Computer/servers/peripherals

HOW TO ORDER

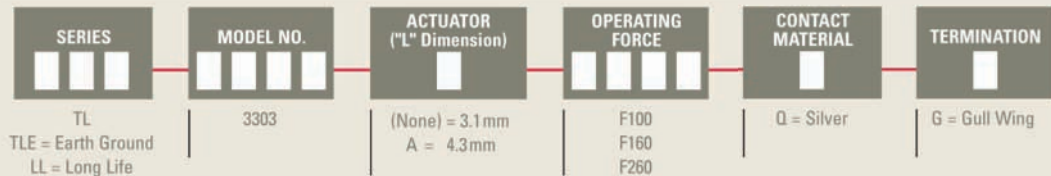

Example Ordering Number

TL-3303-F160-Q-G

Specifications subject to change without notice.

TL 3303/LL 3303

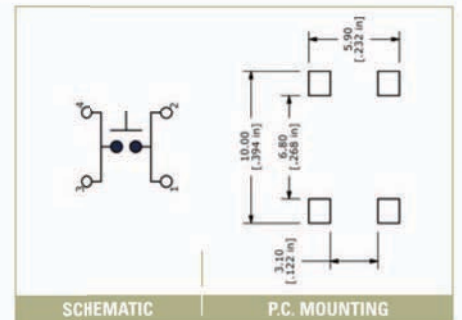
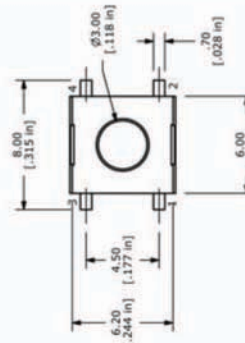
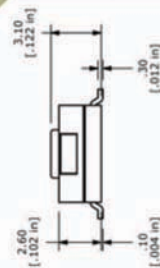

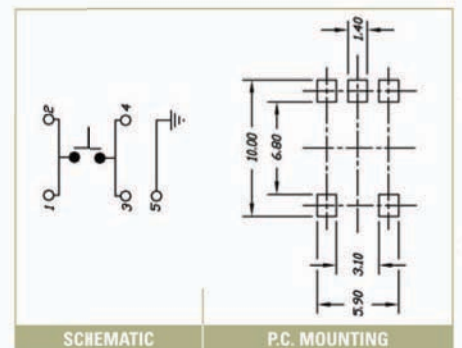
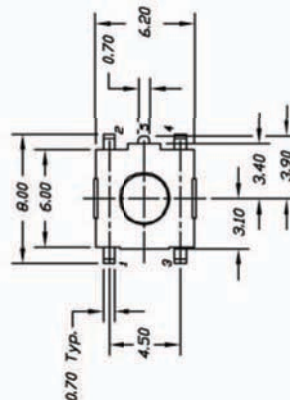
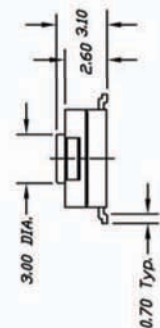

TLE 3303



Looking for pricing, stock, or lifecycle information?

Click below to explore more details on WIN SOURCE:

-  [View TLE3303F260QG on WIN SOURCE](#)
-  [E-Switch Information](#)

Optimize Your Supply Chain with WIN SOURCE Solutions

-  Global Sourcing Solution
-  Obsolete Management
-  Cost Control Management
-  Shortage Management
-  Alternative Solution
-  Excess Inventory Management