

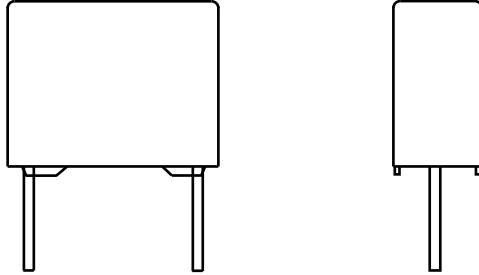

**THE DATASHEET OF
BFC237321475**



DC Film Capacitors MKT Radial Potted Type

FEATURES

- 15 mm to 27.5 mm lead pitch.
Supplied loose in box and taped on reel
- Material categorization:
for definitions of compliance please see www.vishay.com/doc?99912



RoHS
COMPLIANT
HALOGEN
FREE

APPLICATIONS

Blocking and coupling, bypass and energy reservoir

QUICK REFERENCE DATA	
Capacitance tolerance	$\pm 10\%$, $\pm 5\%$
Capacitance range (E12 series)	0.047 μF to 15 μF
Rated DC voltage	100 V, 250 V, 400 V, 630 V
Rated AC voltage	63 V, 160 V, 220 V, 250 V
Climatic testing class (according to IEC 60068-1)	55/105/56
Rated temperature	85 °C
Maximum application temperature	105 °C
Performance grade	Grade 1 (long life)
Leads	Tinned wire
Reference standards	IEC 60384-2
Dielectric	Polyester film
Electrodes	Metallized
Construction	Mono construction 
Encapsulation	Flame retardant plastic case and epoxy resin (UL-class 94 V-0)
Marking	C-value; tolerance; rated voltage; manufacturer's symbol; year and week of manufacturer; manufacturer's type

Note

- For more detailed data and test requirements, contact dc-film@vishay.com

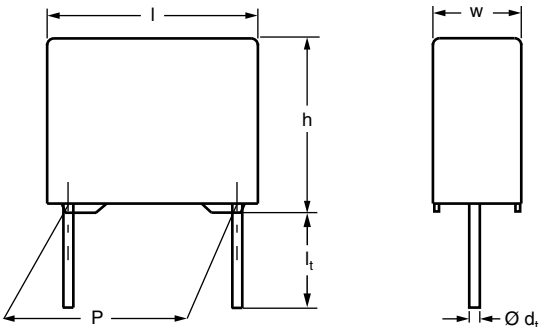
DIMENSIONS



COMPOSITION OF CATALOG NUMBER

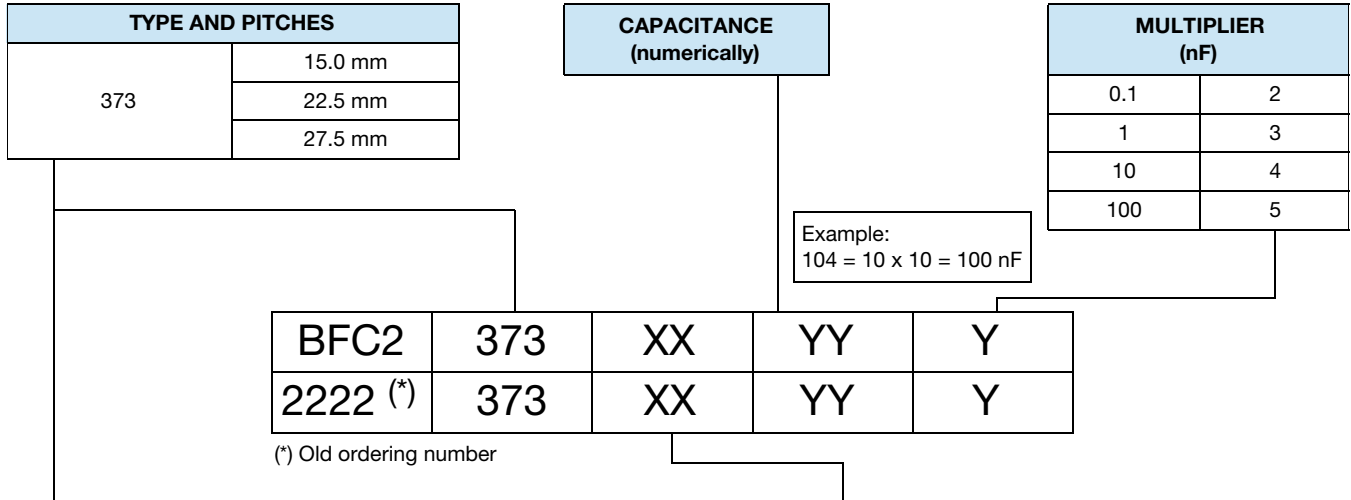

TYPE	PACKAGING	LEAD CONFIGURATION	PREFERRED TYPES				
			C-TOL.	100 V	250 V	400 V	630 V
373 compact	Loose in box	Lead length 5.0 mm ± 1.0 mm	± 10 %	23	43	53	63
	Taped on reel (1)	H (1) = 18.5 mm P ₀ = 12.7 mm Reel diameter = 500 mm	± 5 %	24	44	54	64
			± 10 %	27	47	57	67
373 standard	Loose in box	Lead length 5.0 mm ± 1.0 mm	± 5 %	28	48	58	68
			± 10 %	21	41	51	-
	Taped on reel (1)	H (1) = 18.5 mm P ₀ = 12.7 mm Reel diameter = 500 mm	± 5 %	22	42	52	-
			± 10 %	25	45	55	-
			± 5 %	26	46	56	-

Note

(1) For detailed tape specifications refer to packaging information: www.vishay.com/doc?28139

SPECIFIC REFERENCE DATA				
DESCRIPTION	VALUE			
	at 1 kHz	at 10 kHz	at 100 kHz	
Tangent of loss angle:				
C ≤ 0.1 μF	≤ 75 x 10 ⁻⁴	≤ 130 x 10 ⁻⁴	≤ 250 x 10 ⁻⁴	
0.1 μF < C ≤ 0.47 μF	≤ 75 x 10 ⁻⁴	≤ 130 x 10 ⁻⁴	≤ 300 x 10 ⁻⁴	
0.47 μF < C ≤ 1.0 μF	≤ 75 x 10 ⁻⁴	≤ 130 x 10 ⁻⁴	-	
1.0 μF < C ≤ 10 μF	≤ 75 x 10 ⁻⁴	≤ 150 x 10 ⁻⁴	-	
C > 10 μF	≤ 75 x 10 ⁻⁴	-	-	
Rated voltage pulse slope (dU/dt) _R at	100 V _{DC}	250 V _{DC}	400 V _{DC}	630 V _{DC}
P = 15 mm	14 V/μs	16 V/μs	34 V/μs	90 V/μs
P = 22.5 mm	5 V/μs	7 V/μs	14 V/μs	35 V/μs
P = 27.5 mm	4 V/μs	6 V/μs	12 V/μs	30 V/μs
R between leads, for C ≤ 0.33 μF at 100 V; 1 min at 500 V; 1 min	> 15 000 MΩ	> 15 000 MΩ	> 30 000 MΩ	> 30 000 MΩ
RC between leads, for C > 0.33 μF at 100 V; 1 min at 500 V; 1 min	> 5000 s	> 10 000 s	> 10 000 s	> 10 000 s
R between interconnecting leads and case (foil method)	> 30 000 MΩ			
Withstanding (DC) voltage (cut off current 10 mA) (1); rise time ≤ 1000 V/s	160 V; 1 min	400 V; 1 min	640 V; 1 min	1008 V; 1 min
Withstanding (DC) voltage between leads and case	200 V; 1 min	500 V; 1 min	800 V; 1 min	1260 V; 1 min
Maximum application temperature	105 °C			

Note

(1) See "Voltage Proof Test for Metallized Film Capacitors": www.vishay.com/doc?28169



ELECTRICAL DATA - COMPACT SIZE									
U _{RDC} (V)	CAP. (μF)	DIMENSIONS w x h x l (mm)	MASS (g) ⁽³⁾	CATALOG NUMBER BFC2 373 XYYYY AND PACKAGING				C-VALUE ..YYY	
				LOOSE IN BOX		REEL (500 mm) ⁽¹⁾⁽²⁾			
				l _t = 5.0 mm ± 1.0 mm		H = 18.5 mm; P ₀ = 12.7 mm			
				C-TOL. = ± 10 %	C-TOL. = ± 5 %	C-TOL. = ± 10 %	C-TOL. = ± 5 %		
				XX (SPQ)	XX (SPQ)	XX (SPQ)	XX (SPQ)		
U_{RAC} = 63 V; PITCH = 15.0 mm ± 0.4 mm; d_t = 0.60 mm ± 0.06 mm									
100	0.33	5.0 x 11.0 x 17.5	1.1	23... (1000)	24... (1000)	27... (1100)	28... (1100)	334	
	0.39							394	
	0.47							474	
	0.56							564	
	0.68							684	
	0.82							824	
	1.0							105	
	1.2							125	
	1.5							155	
	1.8	185							
2.2	6.0 x 12.0 x 17.5	1.5	23... (1000)	24... (1000)	27... (900)	28... (900)	225		
U_{RAC} = 63 V; PITCH = 15.0 mm ± 0.4 mm; d_t = 0.80 mm ± 0.08 mm									
2.7	7.0 x 13.5 x 17.5	2.0	23... (1000)	24... (1000)	27... (800)	28... (800)	275		
3.3								335	
3.9	8.5 x 15.0 x 17.5	2.7	23... (1000)	24... (1000)	27... (650)	28... (650)	395		
4.7								475	
U_{RAC} = 160 V; PITCH = 15.0 mm ± 0.40 mm; d_t = 0.60 mm ± 0.06 mm									
250	0.15	5.0 x 11.0 x 17.5	1.1	43... (1000)	44... (1000)	47... (1100)	48... (1100)	154	
	0.18							184	
	0.22							224	
	0.27							274	
	0.32							334	
	0.39	6.0 x 12.0 x 17.5	1.5	43... (1000)	44... (1000)	47... (900)	48... (900)	394	
	0.47							474	
	U_{RAC} = 160 V; PITCH = 15.0 mm ± 0.40 mm; d_t = 0.80 mm ± 0.08 mm								
	0.56	7.0 x 13.5 x 17.5	2.0	43... (1000)	44... (1000)	47... (800)	48... (800)	564	
	0.68							684	
	0.82	8.5 x 15.0 x 17.5	2.7	43... (1000)	44... (1000)	47... (650)	48... (650)	824	
	1.0							105	
	1.2	10.0 x 16.5 x 17.5	3.5	43... (500)	44... (500)	47... (600)	48... (600)	125	
	U_{RAC} = 160 V; PITCH = 22.5 mm ± 0.4 mm; d_t = 0.80 mm ± 0.08 mm								
	1.5	8.5 x 18.0 x 26.0	4.5	43... (200)	44... (200)	47... (450)	48... (450)	155	
	1.8							185	
2.2	10.0 x 19.5 x 26.0	5.7	43... (200)	44... (200)	47... (350)	48... (350)	225		
2.7							275		
U_{RAC} = 160 V; PITCH = 27.5 mm ± 0.4 mm; d_t = 0.80 mm ± 0.08 mm									
3.3	11.0 x 21.0 x 31.0	8.2	43... (100)	44... (100)	-	-	335		
3.9	13.0 x 23.0 x 31.0	10.2	43... (100)	44... (100)	-	-	395		
4.7							475		



ELECTRICAL DATA - COMPACT SIZE															
URDC (V)	CAP. (µF)	DIMENSIONS w x h x l (mm)	MASS (g) ⁽³⁾	CATALOG NUMBER BFC2 373 XXYY AND PACKAGING				C-VALUE ..YYY							
				LOOSE IN BOX		REEL (500 mm) ⁽¹⁾⁽²⁾									
				l _t = 5.0 mm ± 1.0 mm		H = 18.5 mm; P ₀ = 12.7 mm									
				C-TOL. = ± 10 %	C-TOL. = ± 5 %	C-TOL. = ± 10 %	C-TOL. = ± 5 %								
				XX (SPQ)	XX (SPQ)	XX (SPQ)	XX (SPQ)								
URAC = 220 V; PITCH = 15.0 mm ± 0.4 mm; d_t = 0.60 mm ± 0.06 mm															
400	0.047 0.056 0.068 0.082 0.10 0.12 0.15	5.0 x 11.0 x 17.5	1.1	53... (1000)	54... (1000)	57... (1100)	58... (1100)	473 563 683 823 104 124 154							
	0.18 0.22							6.0 x 12.0 x 17.5	1.5	53... (1000)	54... (1000)	57... (900)	58... (900)	184 224	
	URAC = 220 V; PITCH = 15.0 mm ± 0.4 mm; d_t = 0.80 mm ± 0.08 mm														
	0.27 0.33							7.0 x 13.5 x 17.5	2.0	53... (1000)	54... (1000)	57... (800)	58... (800)	274 334	
	0.39 0.47													8.5 x 15.0 x 17.5	2.7
	0.56							10.0 x 16.5 x 17.5	3.5	53... (500)	54... (500)	57... (600)	58... (600)		
	URAC = 220 V; PITCH = 22.5 mm ± 0.4 mm; d_t = 0.80 mm ± 0.08 mm														
	0.68 0.82	8.5 x 18.0 x 26.0	4.5	53... (200)	54... (200)	57... (450)	58... (450)	684 824							
	1.0 1.2							10.0 x 19.5 x 26.0	5.7	53... (200)	54... (200)	57... (350)	58... (350)	105 125	
	URAC = 220 V; PITCH = 27.5 mm ± 0.4 mm; d_t = 0.80 mm ± 0.08 mm														
	1.5	11.0 x 21.0 x 31.0	8.2	53... (100)	54... (100)	-	-	155							
	1.8 2.2							13.0 x 23.0 x 31.0	10.2	53... (100)	54... (100)	-	-	185 225	
	URAC = 250 V; PITCH = 15.0 mm ± 0.4 mm; d_t = 0.60 mm ± 0.06 mm														
	630	0.047 0.056	5.0 x 11.0 x 17.5	1.1	63... (1000)	64... (1000)	67... (1100)	68... (1100)	473 563						
0.068 0.082		6.0 x 12.0 x 17.5							1.5	63... (1000)	64... (1000)	67... (900)	68... (900)	683 823	
URAC = 250 V; PITCH = 15.0 mm ± 0.4 mm; d_t = 0.80 mm ± 0.08 mm															
0.10 0.12		7.0 x 13.5 x 17.5	2.0	63... (1000)	64... (1000)	67... (800)	68... (800)	104 124							
0.15 0.18								8.5 x 15.0 x 17.5	2.7	63... (1000)	64... (1000)	67... (650)	68... (650)	154 184	
0.22		10.0 x 16.5 x 17.5	3.5	63... (500)	64... (500)	67... (600)	68... (600)							224	
URAC = 250 V; PITCH = 22.5 mm ± 0.4 mm; d_t = 0.80 mm ± 0.08 mm															
0.27 0.33		8.5 x 18.0 x 26.0	4.5	63... (200)	64... (200)	67... (450)	68... (450)	274 334							
0.39 0.47								10.0 x 19.5 x 26.0	5.7	63... (200)	64... (200)	67... (350)	68... (350)	394 474	
URAC = 250 V; PITCH = 27.5 mm ± 0.4 mm; d_t = 0.80 mm ± 0.08 mm															
0.56		11.0 x 21.0 x 31.0	8.2	63... (100)	64... (100)	-	-	564							
0.68 0.82								13.0 x 23.0 x 31.0	10.2	63... (100)	64... (100)	-	-	684 824	
1.00		15.0 x 25.0 x 31.5	13.4	63... (100)	64... (100)	-	-							105	

Notes

• SPQ = Standard Packing Quantity

(1) Reel diameter = 356 mm is available on request

(2) H = in-tape height; P₀ = sprocket hole distance; for detailed specifications refer to packaging information: www.vishay.com/doc?28139

(3) Weight for short lead product only



ELECTRICAL DATA - STANDARD SIZE											
U _{RDC} (V)	C (μF)	DIMENSIONS w x h x l (mm)	MASS (g) ⁽³⁾	CATALOG NUMBER BFC2 373 XYYYY AND PACKAGING				C-VALUE ..YYY			
				LOOSE IN BOX		REEL (500 mm) ⁽¹⁾⁽²⁾					
				l _t = 5.0 mm ± 1.0 mm		H = 18.5 mm; P ₀ = 12.7 mm					
				C-TOL. = ± 10 %	C-TOL. = ± 5 %	C-TOL. = ± 10 %	C-TOL. = ± 5 %				
				XX (SPQ)	XX (SPQ)	XX (SPQ)	XX (SPQ)				
U_{RAC} = 63 V; PITCH = 15.0 mm ± 0.4 mm; d_t = 0.60 mm ± 0.06 mm											
100	0.33 0.39 0.47 0.56 0.68	5.0 x 11.0 x 17.5	1.1	21... (1000)	22... (1000)	25... (1100)	26... (1100)	334 394 474 564 684			
	0.82 1.00			6.0 x 12.0 x 17.5	1.5	21... (1000)	22... (1000)	25... (900)	26... (900)	824 105	
	U_{RAC} = 63 V; PITCH = 15.0 mm ± 0.4 mm; d_t = 0.80 mm ± 0.08 mm										
	1.2 1.5			7.0 x 13.5 x 17.5	2.0	21... (1000)	22... (1000)	25... (800)	26... (800)	125 155	
	1.8 2.2					8.5 x 15.0 x 17.5	2.7	21... (1000)	22... (1000)	25... (650)	26... (650)
	U_{RAC} = 63 V; PITCH = 22.5 mm ± 0.4 mm; d_t = 0.80 mm ± 0.08 mm										
	2.7 3.3	8.5 x 18.0 x 26.0	4.5	21... (200)	22... (200)	25... (450)	26... (450)	275 335			
	3.9 4.7			10.0 x 19.5 x 26.0	5.7	21... (200)	22... (200)	25... (350)	26... (350)	395 475	
	U_{RAC} = 63 V; PITCH = 27.5 mm ± 0.4 mm; d_t = 0.80 mm ± 0.08 mm										
	5.6 6.8	11.0 x 21.0 x 31.0	8.2	21... (100)	22... (100)	-	-	565 685			
	8.2 10			13.0 x 23.0 x 31.0	10.2	21... (100)	22... (100)	-	-	825 106	
	12 15	18.0 x 28.0 x 31.5	18.4			21... (100)	22... (100)	-	-	126 156	
U_{RAC} = 160 V; PITCH = 15.0 mm ± 0.4 mm; d_t = 0.60 mm ± 0.06 mm											
250	0.15 0.18 0.22	5.0 x 11.0 x 17.5	1.1	41... (1000)	42... (1000)	45... (1100)	46... (1100)	154 184 224			
	0.27 0.33 0.39 0.47			6.0 x 12.0 x 17.5	1.5	41... (1000)	42... (1000)	45... (900)	46... (900)	274 334 394 474	
	U_{RAC} = 160 V; PITCH = 15.0 mm ± 0.4 mm; d_t = 0.80 mm ± 0.08 mm										
	0.56 0.68	7.0 x 13.5 x 17.5	2.0	41... (1000)	42... (1000)	45... (800)	46... (800)	564 684			
	0.82 1.0			8.5 x 15.0 x 17.5	2.7	41... (1000)	42... (1000)	45... (650)	46... (650)	824 105	
	U_{RAC} = 160 V; PITCH = 22.5 mm ± 0.4 mm; d_t = 0.80 mm ± 0.08 mm										
	1.2 1.5	8.5 x 18.0 x 26.0	4.5	41... (200)	42... (200)	45... (450)	46... (450)	125 155			
	1.8 2.2			10.0 x 19.5 x 26.0	5.7	41... (200)	42... (200)	45... (350)	46... (350)	185 225	
	U_{RAC} = 160 V; PITCH = 27.5 mm ± 0.4 mm; d_t = 0.80 mm ± 0.08 mm										
	2.7 3.3	13.0 x 23.0 x 31.0	10.2	41... (100)	42... (100)	-	-	275 335			
	3.9 4.7			15.0 x 28.0 x 31.5	13.4	41... (100)	42... (100)	-	-	395 475	



ELECTRICAL DATA - STANDARD SIZE									
U _{RDC} (V)	C (μF)	DIMENSIONS w x h x l (mm)	MASS (g) ⁽³⁾	CATALOG NUMBER BFC2 373 XXYY AND PACKAGING				C-VALUE ..YYY	
				LOOSE IN BOX		REEL (500 mm) ⁽¹⁾⁽²⁾			
				l _t = 5.0 mm ± 1.0 mm		H = 18.5 mm; P ₀ = 12.7 mm			
				C-TOL. = ± 10 %	C-TOL. = ± 5 %	C-TOL. = ± 10 %	C-TOL. = ± 5 %		
				XX (SPQ)	XX (SPQ)	XX (SPQ)	XX (SPQ)		
U_{RAC} = 220 V; PITCH = 15.0 mm ± 0.4 mm; d_t = 0.60 mm ± 0.06 mm									
400	0.047	5.0 x 11.0 x 17.5	1.1	51... (1000)	52... (1000)	55... (1100)	56... (1100)	473	
	0.056							563	
	0.068							683	
	0.082							823	
	0.10							104	
	0.12	6.0 x 12.0 x 17.5	1.5	51... (1000)	52... (1000)	55... (900)	56... (900)	124	
	0.15							154	
	U_{RAC} = 220 V; PITCH = 15.0 mm ± 0.4 mm; d_t = 0.80 mm ± 0.08 mm								
	0.18	7.0 x 13.5 x 17.5	2.0	51... (1000)	52... (1000)	55... (800)	56... (800)	184	
	0.22							224	
	0.27	8.5 x 15.0 x 17.5	2.7	51... (1000)	52... (1000)	55... (650)	56... (650)	274	
	0.33							334	
	U_{RAC} = 220 V; PITCH = 22.5 mm ± 0.4 mm; d_t = 0.80 mm ± 0.08 mm								
	0.39	8.5 x 18.0 x 26.0	4.5	51... (200)	52... (200)	55... (450)	56... (450)	394	
	0.47							474	
	0.56	10.0 x 19.5 x 26.0	5.7	51... (200)	52... (200)	55... (350)	56... (350)	564	
0.68	684								
U_{RAC} = 220 V; PITCH = 27.5 mm ± 0.4 mm; d_t = 0.80 mm ± 0.08 mm									
0.82	13.0 x 23.0 x 31.0	10.2	51... (100)	52... (100)	-	-	824		
1.0							105		
1.2							15.0 x 25.0 x 31.5	13.4	51... (100)
1.5	125								

Notes

- SPQ = Standard Packing Quantity

(1) Reel diameter = 356 mm is available on request

(2) H = in-tape height; P₀ = sprocket hole distance; for detailed specifications refer to packaging information: www.vishay.com/doc?28139

(3) Weight for short lead product only



ELECTRICAL DATA - AVAILABLE ON REQUEST										
U _{RDC} (V)	C (μF)	DIMENSIONS w x h x l (mm)	MASS (g) ⁽³⁾	CATALOG NUMBER BFC2 373 XXYYY AND PACKAGING						
				LOOSE IN BOX			REEL (500 mm) ⁽¹⁾⁽²⁾			
				l _t = 5.0 mm ± 1.0 mm			H = 18.5 mm			
				C-TOL. = ± 10 %	C-TOL. = ± 5 %	SPQ	C-TOL. = ± 10 %	C-TOL. = ± 5 %	SPQ	
U_{RAC} = 63 V; PITCH = 22.5 mm ± 0.4 mm; d_t = 0.80 mm ± 0.08 mm										
100	1.5	6.0 x 15.5 x 26.0	2.7	90012	90013	300	90018	90019	600	
	1.8	7.0 x 16.5 x 26.0	3.3	90022	90023	200	90028	90029	550	
	2.2			90002	90003		90008	90009		
	U_{RAC} = 63 V; PITCH = 27.5 mm ± 0.4 mm; d_t = 0.80 mm ± 0.08 mm									
4.7	9.0 x 19.0 x 31.0	6.1	90032	90033	100	-				
U_{RAC} = 160 V; PITCH = 22.5 mm ± 0.4 mm; d_t = 0.80 mm ± 0.08 mm										
250	0.47	6.0 x 15.5 x 26.0	2.7	90042	90046	300	90048	90049	600	
	0.56			90052	90053		90058	90059		
	0.68			90062	90063		90068	90069		
	0.82	7.0 x 16.5 x 26.0	3.3	90072	90073	200	90078	90079	550	
	1.0			90082	90083		90088	90089		
	U_{RAC} = 160 V; PITCH = 27.5 mm ± 0.4 mm; d_t = 0.80 mm ± 0.08 mm									
	1.2	9.0 x 19.0 x 31.5	6.1	90172	90173	100	-			
	1.5			90092	90093					
1.8	9.0 x 21.0 x 31.0	8.2	90102	90103	100	-				
2.2			90112	90113						
U_{RAC} = 220 V; PITCH = 22.5 mm ± 0.4 mm; d_t = 0.80 mm ± 0.08 mm										
400	0.22	6.0 x 15.5 x 26.0	2.7	90122	90123	300	90128	90129	600	
	0.27	7.0 x 16.5 x 26.0	3.3	90132	90133	200	90138	90139	550	
	0.33			90142	90143		90148	90149		
	U_{RAC} = 220 V; PITCH = 27.5 mm ± 0.4 mm; d_t = 0.80 mm ± 0.08 mm									
0.68	9.0 x 19.0 x 31.5	6.1	90152	90153	100	-				

Notes

- SPQ = Standard Packing Quantity

(1) Reel diameter = 356 mm is available on request

(2) H = in-tape height; P₀ = sprocket hole distance; for detailed specifications refer to packaging information: www.vishay.com/doc?28139

(3) Weight for short lead product only

MOUNTING

Normal Use

The capacitors are designed for mounting on printed-circuit boards. The capacitors packed in bandoliers are designed for mounting in printed-circuit boards by means of automatic insertion machines.

For detailed tape specifications refer to packaging information: www.vishay.com/doc?28139

Specific Method of Mounting to Withstand Vibration and Shock

In order to withstand vibration and shock tests, it must be ensured that stand-off pips are in good contact with the printed-circuit board:

- For pitches ≤ 15 mm capacitors shall be mechanically fixed by the leads
- For larger pitches the capacitors shall be mounted in the same way and the body clamped

SPACE REQUIREMENTS FOR PRINTED-CIRCUIT BOARD APPLICATIONS AND DIMENSION TOLERANCES

The maximum space for length ($l_{max.}$), width ($w_{max.}$) and height ($h_{max.}$) of film capacitors to take in account on the printed-circuit board is shown in the drawing:

- For products with pitch ≤ 15 mm, $\Delta w = \Delta l = 0.3$ mm and $\Delta h = 0.1$ mm
- For products with 15 mm $<$ pitch ≤ 27.5 mm, $\Delta w = \Delta l = 0.5$ mm and $\Delta h = 0.1$ mm

Eccentricity defined as in drawing. The maximum eccentricity is smaller than or equal to the lead diameter of the product concerned.

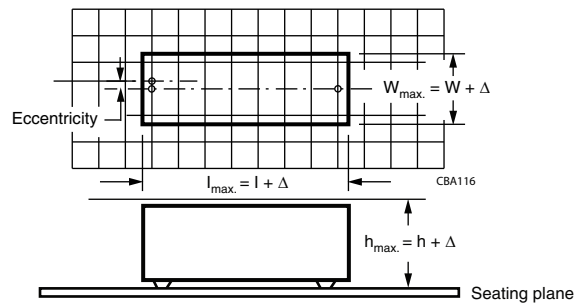

For the minimum product dimensions for length ($l_{min.}$), width ($w_{min.}$), and height ($h_{min.}$) following tolerances of the components are valid:

$l_{min.} = l - \Delta l$, $w_{min.} = w - \Delta w$, and $h_{min.} = h - \Delta h$ following

- For products with pitch = 15 mm, $\Delta l = 0.5$ mm and $\Delta w = \Delta h = 0.5$ mm
- For products with 15 mm $<$ pitch ≤ 27.5 mm, $\Delta l = 1.0$ mm and $\Delta w = \Delta h = 0.5$ mm

SOLDERING

For general soldering conditions and wave soldering profile, we refer to the application note:

“Soldering Guidelines for Film Capacitors”: www.vishay.com/doc?28171

Storage Temperature

$T_{stg} = -25$ °C to $+35$ °C with RH maximum 75 % without condensation

Ratings and Characteristics Reference Conditions

Unless otherwise specified, all electrical values apply to an ambient free air temperature of 23 °C ± 1 °C, an atmospheric pressure of 86 kPa to 106 kPa and a relative humidity of 50 % ± 2 %.

For reference testing, a conditioning period shall be applied over 96 h ± 4 h by heating the products in a circulating air oven at the rated temperature and a relative humidity not exceeding 20 %.

CHARACTERISTICS

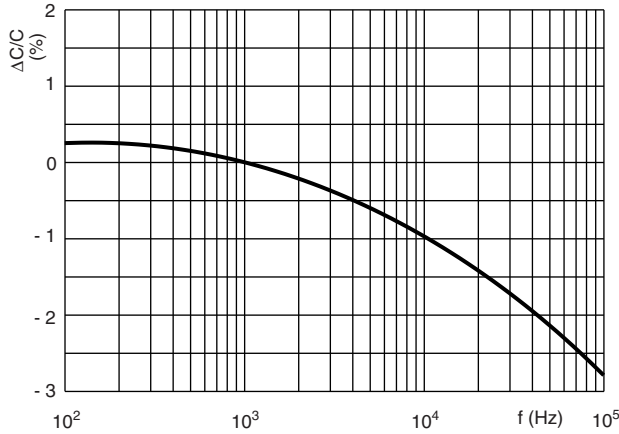

Capacitance as a function of frequency

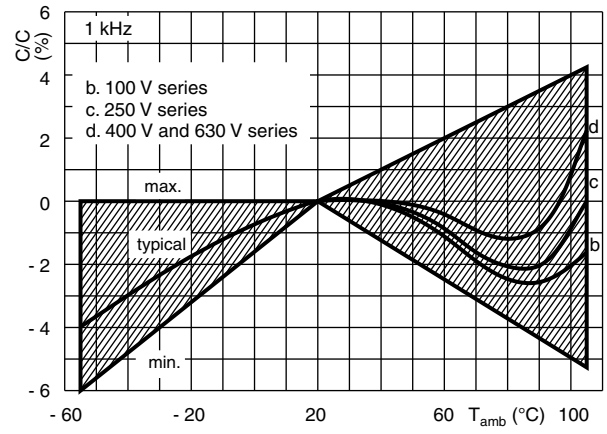

Capacitance as a function of ambient temperature

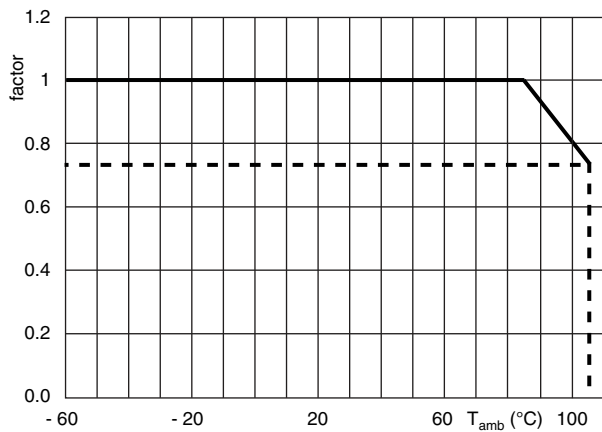

Max. DC and AC voltage as a function of temperature

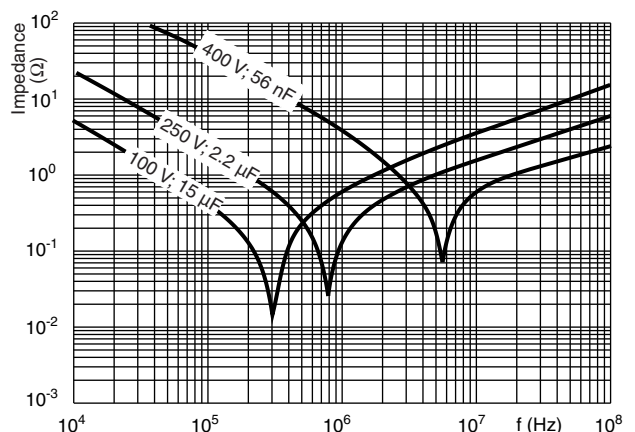

Impedance as a function of frequency

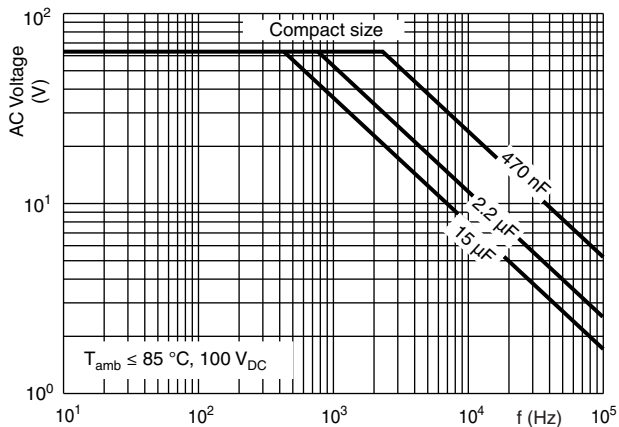

Max. AC voltage as a function of frequency

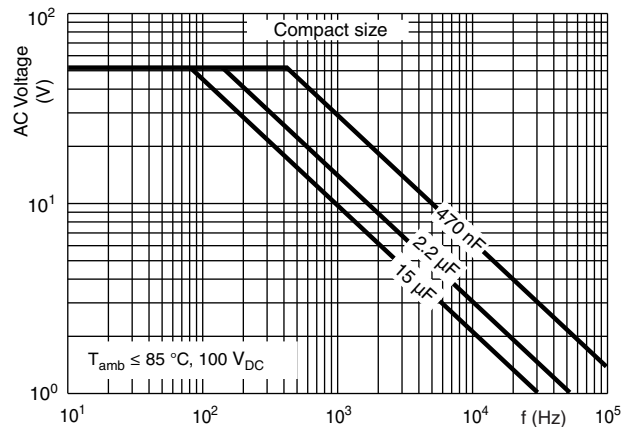

Max. AC voltage as a function of frequency

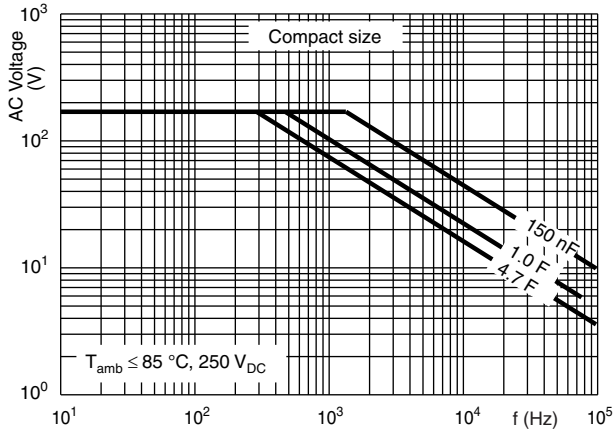

Max. AC voltage as a function of frequency

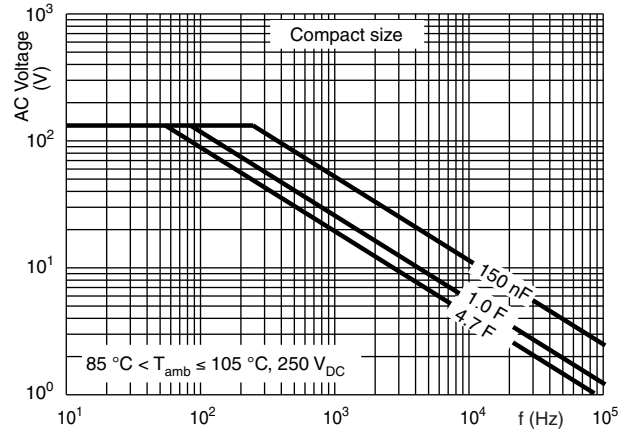

Max. AC voltage as a function of frequency

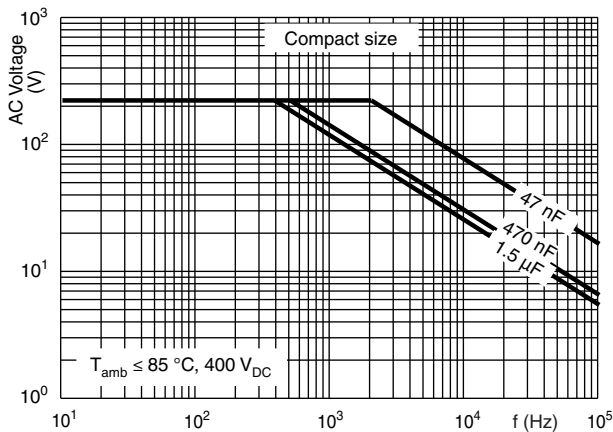

Max. AC voltage as a function of frequency

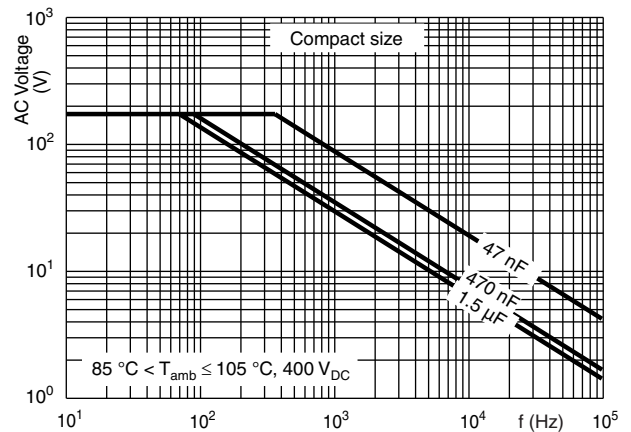

Max. AC voltage as a function of frequency

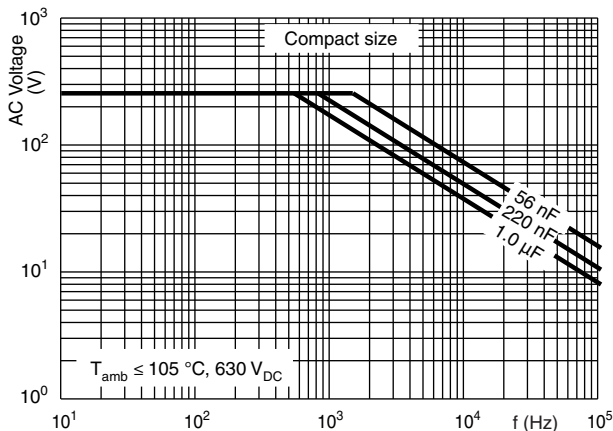

Max. AC voltage as a function of frequency

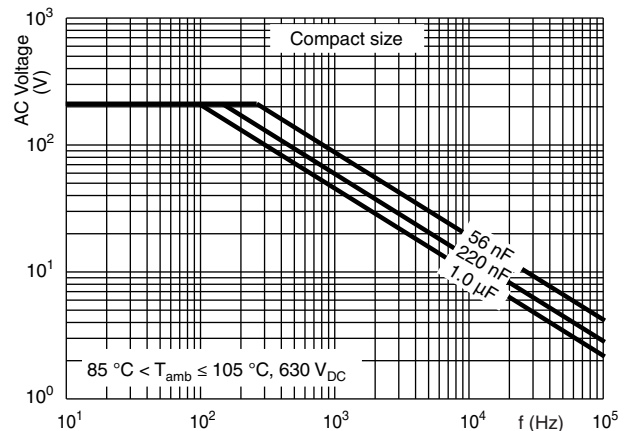

Max. AC voltage as a function of frequency

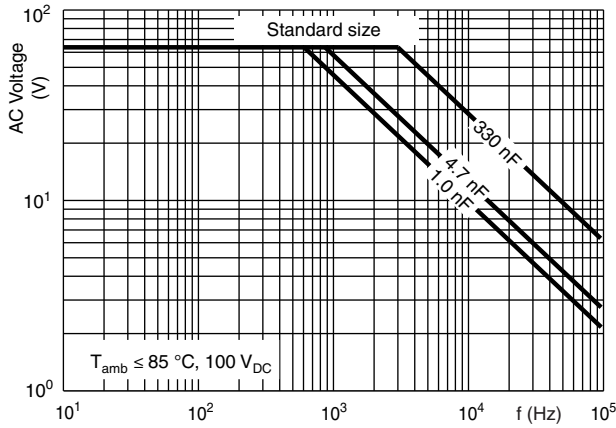

Max. AC voltage as a function of frequency

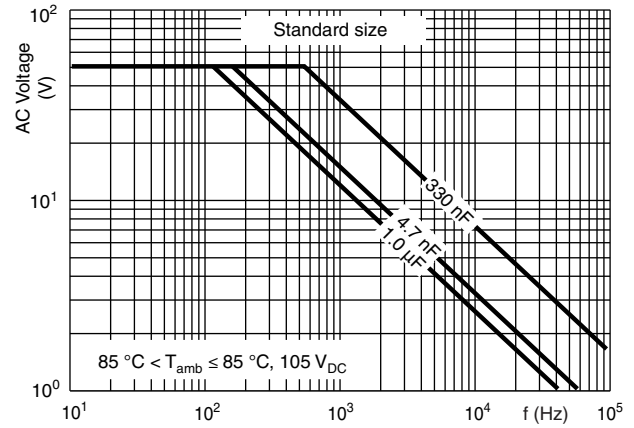

Max. AC voltage as a function of frequency

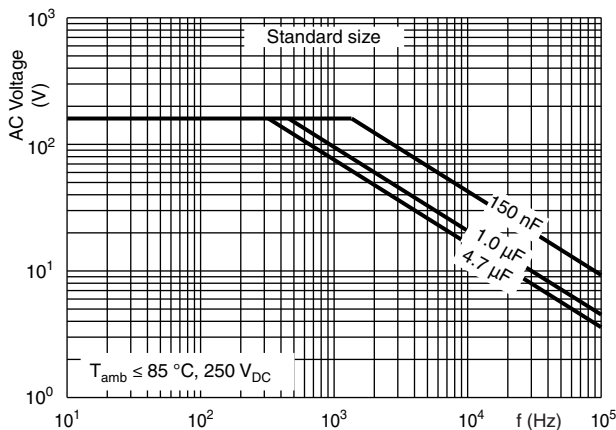

Max. AC voltage as a function of frequency

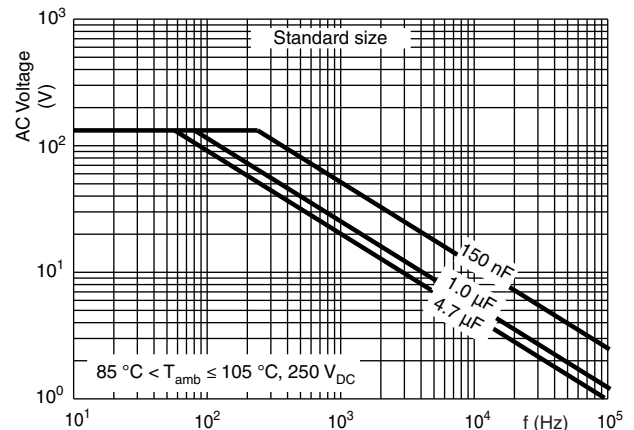

Max. AC voltage as a function of frequency

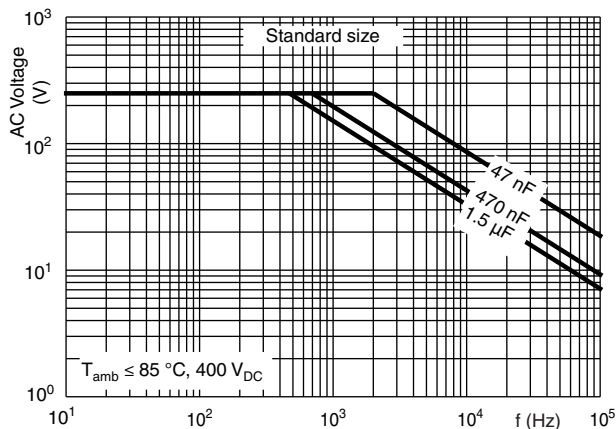

Max. AC voltage as a function of frequency

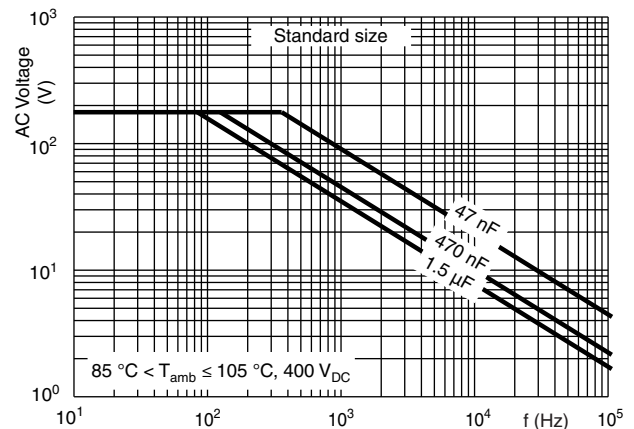

Max. AC voltage as a function of frequency

Maximum RMS current (sinewave) as a function of frequency

U_{AC} is the maximum AC voltage depending on the ambient temperature in the curves “Max. RMS voltage and AC current as a function of frequency”.

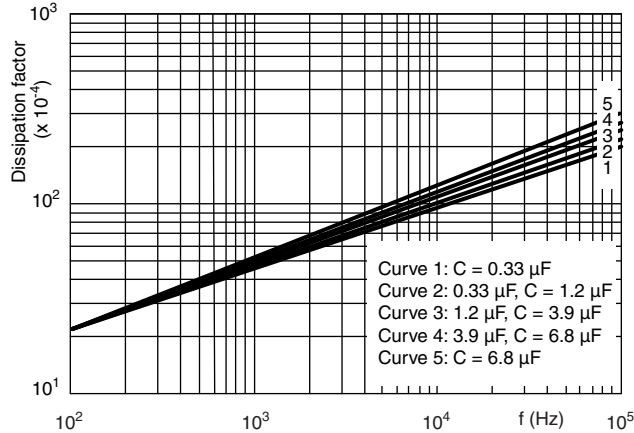

Tangent of loss angle as a function of frequency

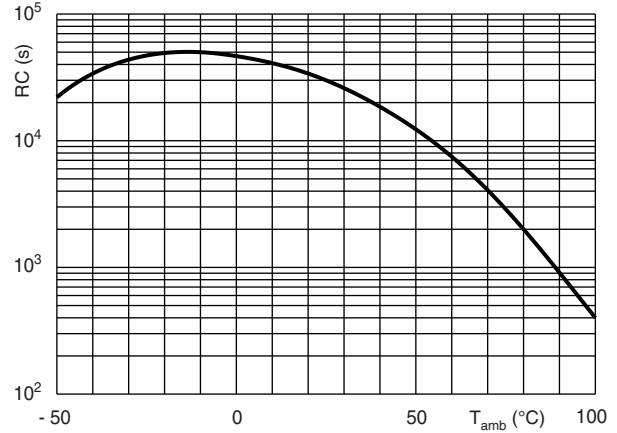

Insulation resistance as a function of the ambient temperature (typical curve)

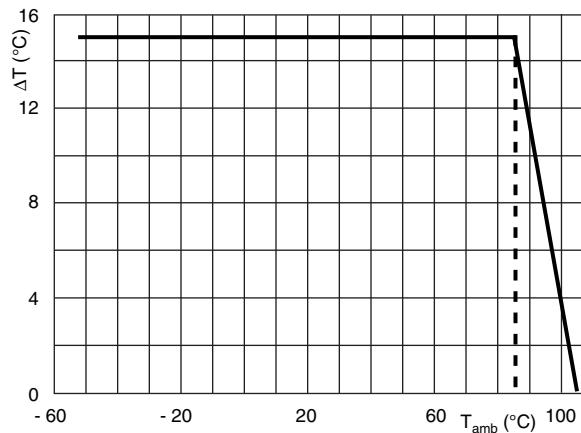
 Maximum allowed component temperature rise (ΔT) as a function of the ambient temperature T_{amb} ($^{\circ}\text{C}$)

HEAT CONDUCTIVITY (G) AS A FUNCTION OF (ORIGINAL) PITCH AND CAPACITOR BODY THICKNESS IN $\text{mW}/^{\circ}\text{C}$

$W_{MAX.}$ (mm)	HEAT CONDUCTIVITY ($\text{mW}/^{\circ}\text{C}$)		
	PITCH 15.0 mm	PITCH 22.5 mm	PITCH 27.5 mm
5.0	10	-	-
6.0	11	19	-
7.0	12	21	-
8.5	16	25	-
10.0	18	28	-
11.0	-	-	36
13.0	-	-	42
15.0	-	-	48
18.0	-	-	57

POWER DISSIPATION AND MAXIMUM COMPONENT TEMPERATURE RISE

The power dissipation must be limited in order not to exceed the maximum allowed component temperature rise as a function of the free ambient temperature.

The power dissipation can be calculated according type detail specification “HQN-384-01/101: Technical Information Film Capacitors”, www.vishay.com/doc?28147.

The component temperature rise (ΔT) can be measured (see section “Measuring the component temperature” for more details) or calculated by $\Delta T = P/G$:

- ΔT = component temperature rise ($^{\circ}\text{C}$)
- P = power dissipation of the component (mW)
- G = heat conductivity of the component ($\text{mW}/^{\circ}\text{C}$)

MEASURING THE COMPONENT TEMPERATURE

A thermocouple must be attached to the capacitor body as in:

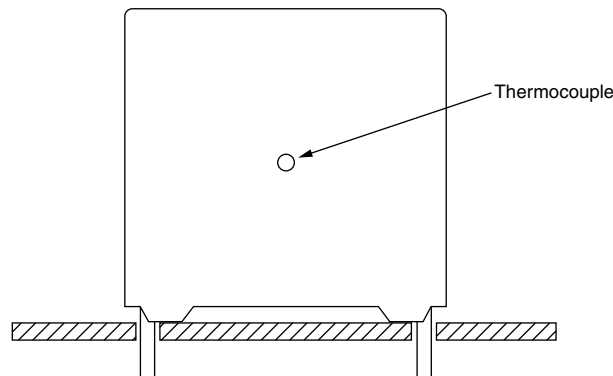

The temperature is measured in unloaded (T_{amb}) and maximum loaded condition (T_{C}).

The temperature rise is given by $\Delta T = T_{\text{C}} - T_{\text{amb}}$.

To avoid radiation or convection, the capacitor should be tested in a wind-free box.

APPLICATION NOTE AND LIMITING CONDITIONS

These capacitors are not suitable for mains applications as across-the-line capacitors without additional protection, as described hereunder. These mains applications are strictly regulated in safety standards and therefore electromagnetic interference suppression capacitors conforming the standards must be used.

For capacitors connected in parallel, normally the proof voltage and possibly the rated voltage must be reduced. For information depending of the capacitance value and the number of parallel connections contact: dc-film@vishay.com

To select the capacitor for a certain application, the following conditions must be checked:

1. The peak voltage (U_{P}) shall not be greater than the rated DC voltage (U_{RDC})
2. The peak-to-peak voltage ($U_{\text{P-P}}$) shall not be greater than $2\sqrt{2} \times U_{\text{RAC}}$ to avoid the ionization inception level
3. The voltage peak slope (dU/dt) shall not exceed the rated voltage pulse slope in an RC-circuit at rated voltage and without ringing. If the pulse voltage is lower than the rated DC voltage, the rated voltage pulse slope may be multiplied by U_{RDC} and divided by the applied voltage.

For all other pulses following equation must be fulfilled:

$$2 \times \int_0^T \left(\frac{dU}{dt} \right)^2 \times \left(dt < U_{\text{RDC}} \times \left(\frac{dU}{dt} \right)_{\text{rated}} \right)$$

T is the pulse duration.

4. The maximum component surface temperature rise must be lower than the limits (see graph “Max. allowed component temperature rise”).
5. Since in circuits used at voltages over 280 V peak-to-peak the risk for an intrinsically active flammability after a capacitor breakdown (short circuit) increases, it is recommended that the power to the component is limited to 100 times the values mentioned in the table: “Heat Conductivity”
6. When using these capacitors as across-the-line capacitor in the input filter for mains applications the applicant must guarantee that the following conditions are fulfilled in any case (spikes and surge voltages from the mains included).
7. For continuous use as series connection with an impedance to the mains, please refer to application note www.vishay.com/doc?28153.

VOLTAGE CONDITIONS FOR 6 ABOVE		
ALLOWED VOLTAGES	$T_{amb} \leq 85\text{ }^{\circ}\text{C}$	$85\text{ }^{\circ}\text{C} < T_{amb} \leq 105\text{ }^{\circ}\text{C}$
Maximum continuous RMS voltage	U_{RAC}	See "Max. AC voltage as function of temperature" per characteristics
Maximum temperature RMS-overvoltage (< 24 h)	$1.25 \times U_{RAC}$	U_{RAC}
Maximum peak voltage (V_{O-P}) (< 2 s)	$1.6 \times U_{RDC}$	$1.3 \times U_{RDC}$

Example

$C = 330\text{ nF} - 63\text{ V}$ used for the voltage signal shown in next drawing.

$U_{P-P} = 40\text{ V}$; $U_P = 35\text{ V}$; $T_1 = 100\text{ }\mu\text{s}$; $T_2 = 200\text{ }\mu\text{s}$

The ambient temperature is $35\text{ }^{\circ}\text{C}$

Checking conditions:

1. The peak voltage $U_P = 35\text{ V}$ is lower than 63 V_{DC}
2. The peak-to-peak voltage 40 V is lower than $2\sqrt{2} \times 40\text{ V}_{AC} = 113\text{ V}_{P-P}$
3. The voltage pulse slope (dU/dt) = $40\text{ V}/100\text{ }\mu\text{s} = 0.4\text{ V}/\mu\text{s}$
This is lower than $60\text{ V}/\mu\text{s}$ (see specific reference data for each version)
4. The dissipated power is 16.2 mW as calculated with fourier terms
The temperature rise for $W_{max.} = 3.5\text{ mm}$ and pitch = 5 mm will be $16.2\text{ mW}/3.0\text{ mW}/^{\circ}\text{C} = 5.4\text{ }^{\circ}\text{C}$
This is lower than $15\text{ }^{\circ}\text{C}$ temperature rise at $35\text{ }^{\circ}\text{C}$, according figure "Max. allowed component temperature rise"
5. Not applicable
6. Not applicable
7. Not applicable

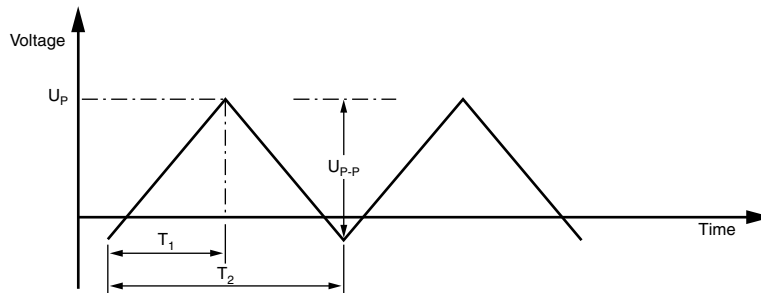
Voltage Signal

INSPECTION REQUIREMENTS
General Notes

Sub-clause numbers of tests and performance requirements refer to the "Sectional Specification, Publication IEC 60384-2 and Specific Reference Data".

GROUP C INSPECTION REQUIREMENTS		
SUB-CLAUSE NUMBER AND TEST	CONDITIONS	PERFORMANCE REQUIREMENTS
SUB-GROUP C1A PART OF SAMPLE OF SUB-GROUP C1		
4.1 Dimensions (detail)		As specified in chapters "General Data" of this specification
4.3.1 Initial measurements	Capacitance Tangent of loss angle: for $C \leq 470\text{ nF}$ at 100 kHz for $470\text{ nF} < C \leq 10\text{ }\mu\text{F}$ at 10 kHz for $C > 10\text{ }\mu\text{F}$ at 1 kHz	
4.3 Robustness of terminations	Tensile and bending	No visible damage
4.4 Resistance to soldering heat	Method: 1A Solder bath: $280\text{ }^{\circ}\text{C} \pm 5\text{ }^{\circ}\text{C}$ Duration: 10 s	



GROUP C INSPECTION REQUIREMENTS		
SUB-CLAUSE NUMBER AND TEST	CONDITIONS	PERFORMANCE REQUIREMENTS
SUB-GROUP C1A PART OF SAMPLE OF SUB-GROUP C1		
4.14 Component solvent resistance	Isopropylalcohol at room temperature Method: 2 Immersion time: 5 min ± 0.5 min Recovery time: min. 1 h, max. 2 h	
4.4.2 Final measurements	Visual examination Capacitance Tangent of loss angle	No visible damage Legible marking $ \Delta C/C \leq 2\%$ of the value measured initially Increase of $\tan \delta$ ≤ 0.005 for: $C \leq 100$ nF or ≤ 0.010 for: 100 nF < $C \leq 220$ nF or ≤ 0.015 for: 220 nF < $C \leq 470$ nF and ≤ 0.003 for: $C > 470$ nF Compared to values measured in 4.3.1
SUB-GROUP C1B PART OF SAMPLE OF SUB-GROUP C1		
4.6.1 Initial measurements	Capacitance Tangent of loss angle: for $C \leq 470$ nF at 100 kHz for 470 nF < $C \leq 10$ μ F at 10 kHz for $C > 10$ μ F at 1 kHz	No visible damage
4.6 Rapid change of temperature	$\theta A = -55$ °C $\theta B = +105$ °C 5 cycles Duration $t = 30$ min	
4.7 Vibration	Visual examination Mounting: see section "Mounting" of this specification Procedure B4 Frequency range: 10 Hz to 55 Hz Amplitude: 0.75 mm or Acceleration 98 m/s ² (whichever is less severe) Total duration 6 h	No visible damage
4.7.2 Final inspection	Visual examination	No visible damage
4.9 Shock	Mounting: see section "Mounting" of this specification Pulse shape: half sine Acceleration: 490 m/s ² Duration of pulse: 11 ms	
4.9.3 Final measurements	Visual examination Capacitance Tangent of loss angle Insulation resistance	No visible damage $ \Delta C/C \leq 3\%$ of the value measured in 4.6.1 Increase of $\tan \delta$ ≤ 0.005 for: $C \leq 100$ nF or ≤ 0.010 for: 100 nF < $C \leq 220$ nF or ≤ 0.015 for: 220 nF < $C \leq 470$ nF and ≤ 0.003 for: $C > 470$ nF Compared to values measured in 4.6.1 As specified in section "Insulation Resistance" of this specification



GROUP C INSPECTION REQUIREMENTS		
SUB-CLAUSE NUMBER AND TEST	CONDITIONS	PERFORMANCE REQUIREMENTS
SUB-GROUP C1 COMBINED SAMPLE OF SPECIMENS OF SUB-GROUPS C1A AND C1B		
4.10 Climatic sequence		
4.10.2 Dry heat	Temperature: +105 °C Duration: 16 h	
4.10.3 Damp heat cyclic Test Db, first cycle		
4.10.4 Cold	Temperature: -55 °C Duration: 2 h	
4.10.6 Damp heat cyclic Test Db, remaining cycles		
4.10.6.2 Final measurements	Voltage proof = U_{RDC} for 1 min within 15 min after removal from testchamber Visual examination Capacitance Tangent of loss angle Insulation resistance	No breakdown of flash-over No visible damage Legible marking $ \Delta C/C \leq 3\%$ of the value measured in 4.4.2 or 4.9.3 Increase of $\tan \delta$ ≤ 0.005 for: $C \leq 100$ nF or ≤ 0.010 for: 100 nF < $C \leq 220$ nF or ≤ 0.015 for: 220 nF < $C \leq 470$ nF and ≤ 0.005 for: $C > 470$ nF Compared to values measured in 4.3.1 or 4.6.1 $\geq 50\%$ of values specified in section "Insulation Resistance" of this specification
SUB-GROUP C2		
4.11 Damp heat steady state	56 days, 40 °C, 90 % to 95 % RH	
4.11.1 Initial measurements	Capacitance Tangent of loss angle at 1 kHz	
4.11.3 Final measurements	Voltage proof = U_{RDC} for 1 min within 15 min after removal from testchamber Visual examination Capacitance Tangent of loss angle Insulation resistance	No breakdown of flash-over No visible damage Legible marking $ \Delta C/C \leq 5\%$ of the value measured in 4.11.1. Increase of $\tan \delta \leq 0.005$ Compared to values measured in 4.11.1 $\geq 50\%$ of values specified in section "Insulation Resistance" of this specification



GROUP C INSPECTION REQUIREMENTS		
SUB-CLAUSE NUMBER AND TEST	CONDITIONS	PERFORMANCE REQUIREMENTS
SUB GROUP C3		
4.12 Endurance	Duration: 2000 h 1.25 x U _{RDC} at 85 °C 0.8 x 1.25 U _{RDC} at 105 °C	
4.12.1 Initial measurements	Capacitance Tangent of loss angle: for C ≤ 470 nF at 100 kHz for 470 nF < C ≤ 10 µF at 10 kHz for C > 10 µF at 1 kHz	
4.12.5 Final measurements	Visual examination Capacitance Tangent of loss angle Insulation resistance	No visible damage Legible marking ΔC/C ≤ 5 % compared to values measured in 4.12.1 Increase of tan δ ≤ 0.005 for: C ≤ 100 nF or ≤ 0.010 for: 100 nF < C ≤ 220 nF or ≤ 0.015 for: 220 nF < C ≤ 470 nF and ≤ 0.003 for: C > 470 nF Compared to values measured in 4.12.1 ≥ 50 % of values specified in section "Insulation Resistance" of this specification
SUB-GROUP C4		
4.13 Charge and discharge	10 000 cycles Charged to U _{RDC} Discharge resistance: $R = \frac{U_R}{C \times 2.5 \times (dU/dt)_R}$	
4.13.1 Initial measurements	Capacitance Tangent of loss angle: for C ≤ 470 nF at 100 kHz for 470 nF < C ≤ 10 µF at 10 kHz for C > 10 µF at 1 kHz	
4.13.3 Final measurements	Capacitance Tangent of loss angle Insulation resistance	ΔC/C ≤ 3 % compared to values measured in 4.13.1 Increase of tan δ ≤ 0.005 for: C ≤ 100 nF or ≤ 0.010 for: 100 nF < C ≤ 220 nF or ≤ 0.015 for: 220 nF < C ≤ 470 nF and ≤ 0.003 for: C > 470 nF Compared to values measured in 4.13.1 ≥ 50 % of values specified in section "Insulation Resistance" of this specification



Disclaimer

ALL PRODUCT, PRODUCT SPECIFICATIONS AND DATA ARE SUBJECT TO CHANGE WITHOUT NOTICE TO IMPROVE RELIABILITY, FUNCTION OR DESIGN OR OTHERWISE.

Vishay Intertechnology, Inc., its affiliates, agents, and employees, and all persons acting on its or their behalf (collectively, "Vishay"), disclaim any and all liability for any errors, inaccuracies or incompleteness contained in any datasheet or in any other disclosure relating to any product.

Vishay makes no warranty, representation or guarantee regarding the suitability of the products for any particular purpose or the continuing production of any product. To the maximum extent permitted by applicable law, Vishay disclaims (i) any and all liability arising out of the application or use of any product, (ii) any and all liability, including without limitation special, consequential or incidental damages, and (iii) any and all implied warranties, including warranties of fitness for particular purpose, non-infringement and merchantability.

Statements regarding the suitability of products for certain types of applications are based on Vishay's knowledge of typical requirements that are often placed on Vishay products in generic applications. Such statements are not binding statements about the suitability of products for a particular application. It is the customer's responsibility to validate that a particular product with the properties described in the product specification is suitable for use in a particular application. Parameters provided in datasheets and / or specifications may vary in different applications and performance may vary over time. All operating parameters, including typical parameters, must be validated for each customer application by the customer's technical experts. Product specifications do not expand or otherwise modify Vishay's terms and conditions of purchase, including but not limited to the warranty expressed therein.

Hyperlinks included in this datasheet may direct users to third-party websites. These links are provided as a convenience and for informational purposes only. Inclusion of these hyperlinks does not constitute an endorsement or an approval by Vishay of any of the products, services or opinions of the corporation, organization or individual associated with the third-party website. Vishay disclaims any and all liability and bears no responsibility for the accuracy, legality or content of the third-party website or for that of subsequent links.

Except as expressly indicated in writing, Vishay products are not designed for use in medical, life-saving, or life-sustaining applications or for any other application in which the failure of the Vishay product could result in personal injury or death. Customers using or selling Vishay products not expressly indicated for use in such applications do so at their own risk. Please contact authorized Vishay personnel to obtain written terms and conditions regarding products designed for such applications.

No license, express or implied, by estoppel or otherwise, to any intellectual property rights is granted by this document or by any conduct of Vishay. Product names and markings noted herein may be trademarks of their respective owners.

Looking for pricing, stock, or lifecycle information?

Click below to explore more details on WIN SOURCE:

 [View BFC237321475 on WIN SOURCE](#)

 [Vishay Information](#)

Optimize Your Supply Chain with WIN SOURCE Solutions

-  Global Sourcing Solution
-  Obsolete Management
-  Cost Control Management
-  Shortage Management
-  Alternative Solution
-  Excess Inventory Management