



**THE DATASHEET OF  
NLU2G14MUTCG**



# ON Semiconductor

## Is Now

# onsemi™

To learn more about onsemi™, please visit our website at  
[www.onsemi.com](http://www.onsemi.com)

---

**onsemi** and **onsemi** and other names, marks, and brands are registered and/or common law trademarks of Semiconductor Components Industries, LLC dba "**onsemi**" or its affiliates and/or subsidiaries in the United States and/or other countries. **onsemi** owns the rights to a number of patents, trademarks, copyrights, trade secrets, and other intellectual property. A listing of **onsemi** product/patent coverage may be accessed at [www.onsemi.com/site/pdf/Patent-Marking.pdf](http://www.onsemi.com/site/pdf/Patent-Marking.pdf). **onsemi** reserves the right to make changes at any time to any products or information herein, without notice. The information herein is provided "as-is" and **onsemi** makes no warranty, representation or guarantee regarding the accuracy of the information, product features, availability, functionality, or suitability of its products for any particular purpose, nor does **onsemi** assume any liability arising out of the application or use of any product or circuit, and specifically disclaims any and all liability, including without limitation special, consequential or incidental damages. Buyer is responsible for its products and applications using **onsemi** products, including compliance with all laws, regulations and safety requirements or standards, regardless of any support or applications information provided by **onsemi**. "Typical" parameters which may be provided in **onsemi** data sheets and/or specifications can and do vary in different applications and actual performance may vary over time. All operating parameters, including "Typicals" must be validated for each customer application by customer's technical experts. **onsemi** does not convey any license under any of its intellectual property rights nor the rights of others. **onsemi** products are not designed, intended, or authorized for use as a critical component in life support systems or any FDA Class 3 medical devices or medical devices with a same or similar classification in a foreign jurisdiction or any devices intended for implantation in the human body. Should Buyer purchase or use **onsemi** products for any such unintended or unauthorized application, Buyer shall indemnify and hold **onsemi** and its officers, employees, subsidiaries, affiliates, and distributors harmless against all claims, costs, damages, and expenses, and reasonable attorney fees arising out of, directly or indirectly, any claim of personal injury or death associated with such unintended or unauthorized use, even if such claim alleges that **onsemi** was negligent regarding the design or manufacture of the part. **onsemi** is an Equal Opportunity/Affirmative Action Employer. This literature is subject to all applicable copyright laws and is not for resale in any manner. Other names and brands may be claimed as the property of others.

# NLU2G14

## Dual Schmitt-Trigger Inverter

The NLU2G14 MiniGate™ is an advanced high-speed CMOS dual Schmitt-trigger inverter in ultra-small footprint.

The NLU2G14 input and output structures provide protection when voltages up to 7.0 V are applied, regardless of the supply voltage.

The NLU2G14 can be used to enhance noise immunity or to square up slowly changing waveforms.

### Features

- High Speed:  $t_{PD} = 4.0 \text{ ns (Typ) @ } V_{CC} = 5.0 \text{ V}$
- Low Power Dissipation:  $I_{CC} = 1 \mu\text{A (Max) at } T_A = 25^\circ\text{C}$
- Power Down Protection Provided on inputs
- Balanced Propagation Delays
- Overvoltage Tolerant (OVT) Input and Output Pins
- Ultra-Small Packages
- These are Pb-Free Devices

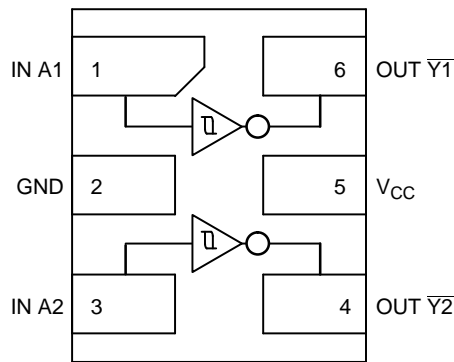

Figure 1. Pinout (Top View)

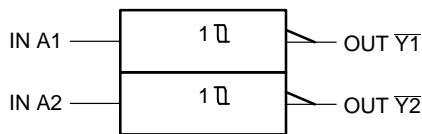

Figure 2. Logic Symbol

### PIN ASSIGNMENT

|   |        |
|---|--------|
| 1 | IN A1  |
| 2 | GND    |
| 3 | IN A2  |
| 4 | OUT Y2 |
| 5 | VCC    |
| 6 | OUT Y1 |

### FUNCTION TABLE

| A | Y |
|---|---|
| L | H |
| H | L |



ON Semiconductor®

[www.onsemi.com](http://www.onsemi.com)

### MARKING DIAGRAMS



1

UDFN6  
1.0 x 1.0  
CASE 517BX



1

UDFN6  
1.2 x 1.0  
CASE 517AA

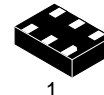

1

UDFN6  
1.45 x 1.0  
CASE 517AQ

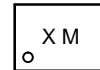

D = Device Marking  
M = Date Code

### ORDERING INFORMATION

See detailed ordering and shipping information in the package dimensions section on page 4 of this data sheet.

# NLU2G14

## MAXIMUM RATINGS

| Symbol        | Parameter  | Value                | Unit |
|---------------|--|----------------------|------|
| $V_{CC}$      | DC Supply Voltage  | -0.5 to +7.0         | V    |
| $V_{IN}$      | DC Input Voltage   | -0.5 to +7.0         | V    |
| $V_{OUT}$     | DC Output Voltage  | -0.5 to +7.0         | V    |
| $I_{IK}$      | DC Input Diode Current<br>$V_{IN} < GND$                           | -20                  | mA   |
| $I_{OK}$      | DC Output Diode Current<br>$V_{OUT} < GND$                         | ±20                  | mA   |
| $I_O$         | DC Output Source/Sink Current                                      | ±12.5                | mA   |
| $I_{CC}$      | DC Supply Current Per Supply Pin                                   | ±25                  | mA   |
| $I_{GND}$     | DC Ground Current per Ground Pin                                   | ±25                  | mA   |
| $T_{STG}$     | Storage Temperature Range  | -65 to +150          | °C   |
| $T_L$         | Lead Temperature, 1 mm from Case for 10 Seconds                    | 260                  | °C   |
| $T_J$         | Junction Temperature Under Bias                                    | 150                  | °C   |
| MSL           | Moisture Sensitivity   | Level 1              |      |
| $F_R$         | Flammability Rating Oxygen<br>Index: 28 to 34                      | UL 94 V-0 @ 0.125 in |      |
| $I_{LATCHUP}$ | Latchup Performance Above $V_{CC}$ and Below GND at 125°C (Note 2) | ±500                 | mA   |

Stresses exceeding those listed in the Maximum Ratings table may damage the device. If any of these limits are exceeded, device functionality should not be assumed, damage may occur and reliability may be affected.

1. Measured with minimum pad spacing on an FR4 board, using 10 mm-by-1 inch, 2 ounce copper trace no air flow.
2. Tested to EIA / JESD78.

## RECOMMENDED OPERATING CONDITIONS

| Symbol              | Parameter  | Min    | Max                  | Unit |
|---------------------|--|--------|----------------------|------|
| $V_{CC}$            | Positive DC Supply Voltage   | 1.65   | 5.5                  | V    |
| $V_{IN}$            | Digital Input Voltage  | 0      | 5.5                  | V    |
| $V_{OUT}$           | Output Voltage   | 0      | 5.5                  | V    |
| $T_A$               | Operating Free-Air Temperature   | -55    | +125                 | °C   |
| $\Delta t/\Delta V$ | Input Transition Rise or Fall Rate<br>$V_{CC} = 3.3 V \pm 0.3 V$<br>$V_{CC} = 5.0 V \pm 0.5 V$ | 0<br>0 | No Limit<br>No Limit | ns/V |

# NLU2G14

## DC ELECTRICAL CHARACTERISTICS

| Symbol          | Parameter                         | Conditions   | V <sub>CC</sub> (V)  | T <sub>A</sub> = 25 °C |      |      | T <sub>A</sub> = +85°C |      | T <sub>A</sub> = -55°C to +125°C |      | Unit |
|-----------------|-----------------------------------|--|--|------------------------|------|------|------------------------|------|----------------------------------|------|------|
|                 |                                   |  |  | Min                    | Typ  | Max  | Min                    | Max  | Min                              | Max  |      |
| V <sub>T+</sub> | Positive Threshold Voltage        |  | 3.0  | 1.85                   | 2.0  | 2.2  |                        | 2.2  |                                  | 2.2  | V    |
|                 |                                   |  | 4.5  | 2.86                   | 3.0  | 3.15 |                        | 3.15 |                                  | 3.15 |      |
|                 |                                   |  | 5.5  | 3.50                   | 3.6  | 3.85 |                        | 3.85 |                                  | 3.85 |      |
| V <sub>T-</sub> | Negative Threshold Voltage        |  | 3.0  | 0.9                    | 1.5  | 1.65 | 0.9                    |      | 0.9                              |      | V    |
|                 |                                   |  | 4.5  | 1.35                   | 2.3  | 2.46 | 1.35                   |      | 1.35                             |      |      |
|                 |                                   |  | 5.5  | 1.65                   | 2.9  | 3.05 | 1.65                   |      | 1.65                             |      |      |
| V <sub>H</sub>  | Hysteresis Voltage                |  | 3.0  | 0.30                   | 0.57 | 1.20 | 0.30                   | 1.20 | 0.30                             | 1.20 | V    |
|                 |                                   |  | 4.5  | 0.40                   | 0.67 | 1.40 | 0.40                   | 1.40 | 0.40                             | 1.40 |      |
|                 |                                   |  | 5.5  | 0.50                   | 0.74 | 1.60 | 0.50                   | 1.60 | 0.50                             | 1.60 |      |
| V <sub>OH</sub> | Minimum High-Level Output Voltage | V <sub>IN</sub> ≤ V <sub>T-MIN</sub><br>I <sub>OH</sub> = -50 μA | 2.0  | 1.9                    | 2.0  |      | 1.9                    |      | 1.9                              |      | V    |
|                 |                                   | 3.0  | 2.9  | 3.0                    |      | 2.9  |                        | 2.9  |                                  |      |      |
|                 |                                   | V <sub>IN</sub> ≤ V <sub>T-MIN</sub><br>I <sub>OH</sub> = -4 mA  | 3.0  | 2.58                   |      |      | 2.48                   |      | 2.34                             |      |      |
|                 |                                   | 4.5  | 3.94   |                        |      | 3.80 |                        | 3.66 |                                  |      |      |
| V <sub>OL</sub> | Maximum Low-Level Output Voltage  | V <sub>IN</sub> ≥ V <sub>T+MAX</sub><br>I <sub>OL</sub> = 50 μA  | 2.0  |                        | 0    | 0.1  |                        | 0.1  |                                  | 0.1  | V    |
|                 |                                   | 3.0  |  | 0                      | 0.1  |      | 0.1                    |      | 0.1                              |      |      |
|                 |                                   |  | 4.5  |                        | 0    | 0.1  |                        | 0.1  |                                  | 0.1  |      |
|                 |                                   |  | V <sub>IN</sub> ≥ V <sub>T+MAX</sub><br>I <sub>OL</sub> = 4 mA | 3.0                    |      |      | 0.36                   |      | 0.44                             |      | 0.52 |
|                 |                                   |  | 4.5  |                        |      | 0.36 |                        | 0.44 |                                  | 0.52 |      |
|                 |                                   |  | I <sub>OL</sub> = 8 mA   | 4.5                    |      |      | 0.36                   |      | 0.44                             |      | 0.52 |
| I <sub>IN</sub> | Input Leakage Current             | 0 ≤ V <sub>IN</sub> ≤ 5.5 V                                      | 0 to 5.5   |                        |      | ±0.1 |                        | ±1.0 |                                  | μA   |      |
| I <sub>CC</sub> | Quiescent Supply Current          | 0 ≤ V <sub>IN</sub> ≤ V <sub>CC</sub>                            | 5.5  |                        |      | 1.0  |                        | 10   |                                  | μA   |      |

## AC ELECTRICAL CHARACTERISTICS (Input t<sub>r</sub> = t<sub>f</sub> = 3.0 ns)

| Symbol                                 | Parameter                              | V <sub>CC</sub> (V) | Test Condition         | T <sub>A</sub> = 25 °C |     |      | T <sub>A</sub> = +85°C |      | T <sub>A</sub> = -55°C to +125°C |      | Unit |
|--|--|---------------------|------------------------|------------------------|-----|------|------------------------|------|----------------------------------|------|------|
|  |  |                     |                        | Min                    | Typ | Max  | Min                    | Max  | Min                              | Max  |      |
| t <sub>pLH</sub> ,<br>t <sub>pHL</sub> | Propagation Delay, Input A to Output Y | 3.0 to 3.6          | C <sub>L</sub> = 15 pF |                        | 7.0 | 12.8 | 1.0                    | 15   | 1.0                              | 17   | ns   |
|  |  |                     | C <sub>L</sub> = 50 pF |                        | 8.5 | 16.3 | 1.0                    | 18.5 | 1.0                              | 20.5 |      |
|  |  | 4.5 to 5.5          | C <sub>L</sub> = 15 pF |                        | 4.0 | 8.6  | 1.0                    | 10   | 1.0                              | 11.5 |      |
|  |  |                     | C <sub>L</sub> = 50 pF |                        | 5.5 | 10.6 | 1.0                    | 12   | 1.0                              | 13.5 |      |
| C <sub>IN</sub>                        | Input Capacitance                      |                     |                        |                        | 5.0 | 10   |                        | 10   |                                  | pF   |      |
| C <sub>PD</sub>                        | Power Dissipation Capacitance (Note 3) | 5.0                 |                        |                        | 7.0 |      |                        |      |                                  | pF   |      |

3. C<sub>PD</sub> is defined as the value of the internal equivalent capacitance which is calculated from the dynamic operating current consumption without load. Average operating current can be obtained by the equation I<sub>CC(OPR)</sub> = C<sub>PD</sub> • V<sub>CC</sub> • f<sub>in</sub> + I<sub>CC</sub>. C<sub>PD</sub> is used to determine the no-load dynamic power consumption: P<sub>D</sub> = C<sub>PD</sub> • V<sub>CC</sub><sup>2</sup> • f<sub>in</sub> + I<sub>CC</sub> • V<sub>CC</sub>.

# NLU2G14

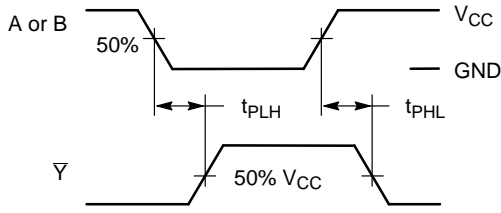
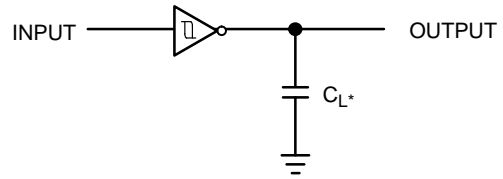
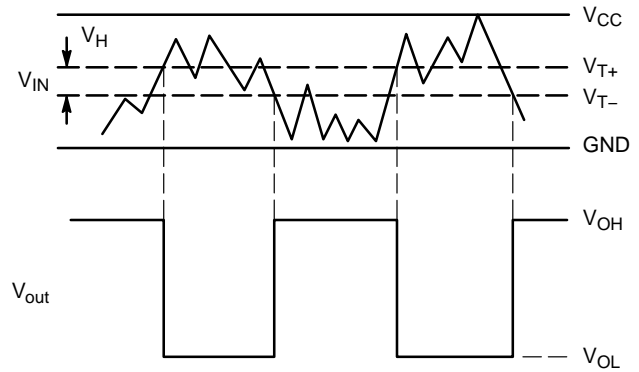
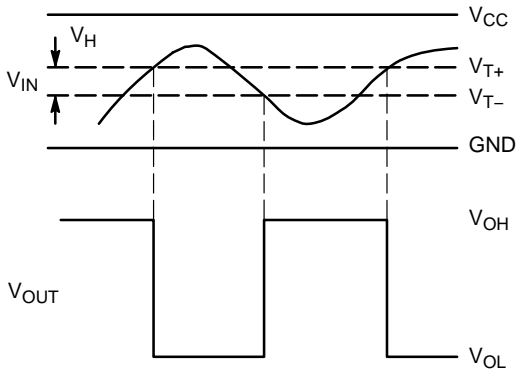

Figure 3. Switching Waveforms



\*Includes all probe and jig capacitance.  
A 1-MHz square input wave is recommended for propagation delay tests.

Figure 4. Test Circuit



(a) A Schmitt-Trigger Squares Up Inputs With Slow Rise and Fall Times

(b) A Schmitt-Trigger Offers Maximum Noise Immunity

Figure 5. Typical Schmitt-Trigger Applications

## ORDERING INFORMATION

| Device                            | Package                              | Shipping†          |
|-----------------------------------|--------------------------------------|--------------------|
| NLU2G14MUTCG                      | UDFN6, 1.2 x 1.0, 0.4P<br>(Pb-Free)  | 3000 / Tape & Reel |
| NLU2G14AMUTCG<br>(In Development) | UDFN6, 1.45 x 1.0, 0.5P<br>(Pb-Free) | 3000 / Tape & Reel |
| NLU2G14CMUTCG<br>(In Development) | UDFN6, 1.0 x 1.0, 0.35P<br>(Pb-Free) | 3000 / Tape & Reel |

†For information on tape and reel specifications, including part orientation and tape sizes, please refer to our Tape and Reel Packaging Specifications Brochure, BRD8011/D.

# NLU2G14

## PACKAGE DIMENSIONS

UDFN6 1.0x1.0, 0.35P  
CASE 517BX  
ISSUE O

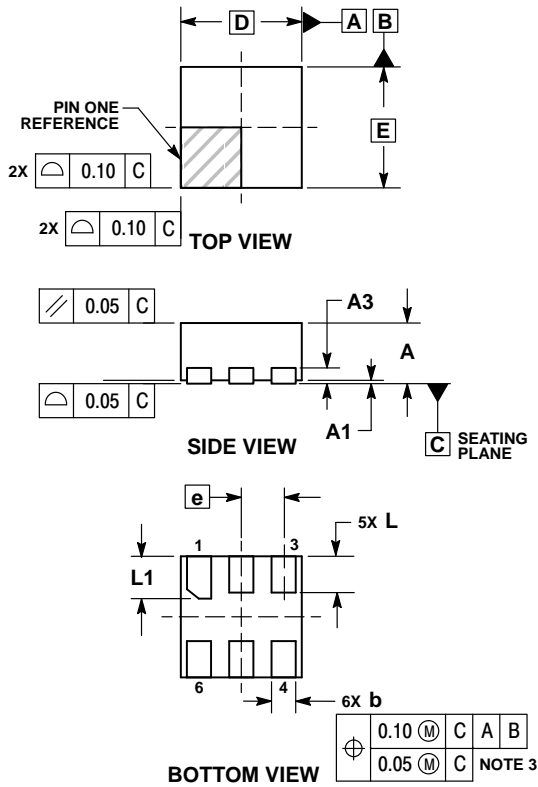

**NOTES:**

1. DIMENSIONING AND TOLERANCING PER ASME Y14.5M, 1994.
2. CONTROLLING DIMENSION: MILLIMETERS.
3. DIMENSION b APPLIES TO PLATED TERMINAL AND IS MEASURED BETWEEN 0.15 AND 0.20 MM FROM TERMINAL TIP.
4. PACKAGE DIMENSIONS EXCLUSIVE OF BURRS AND MOLD FLASH.

| MILLIMETERS |          |      |
|-------------|----------|------|
| DIM         | MIN      | MAX  |
| A           | 0.45     | 0.55 |
| A1          | 0.00     | 0.05 |
| A3          | 0.13 REF |      |
| b           | 0.12     | 0.22 |
| D           | 1.00 BSC |      |
| E           | 1.00 BSC |      |
| e           | 0.35 BSC |      |
| L           | 0.25     | 0.35 |
| L1          | 0.30     | 0.40 |

**RECOMMENDED SOLDERING FOOTPRINT\***

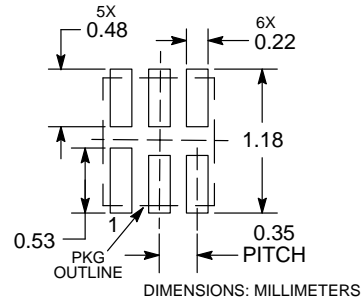

\*For additional information on our Pb-Free strategy and soldering details, please download the ON Semiconductor Soldering and Mounting Techniques Reference Manual, SOLDERRM/D.

# NLU2G14

## PACKAGE DIMENSIONS

UDFN6, 1.2x1.0, 0.4P  
CASE 517AA  
ISSUE C

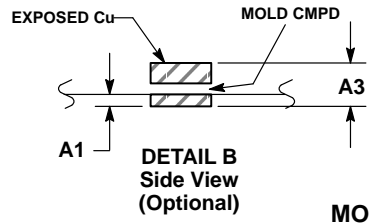
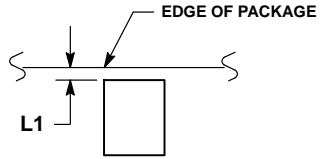
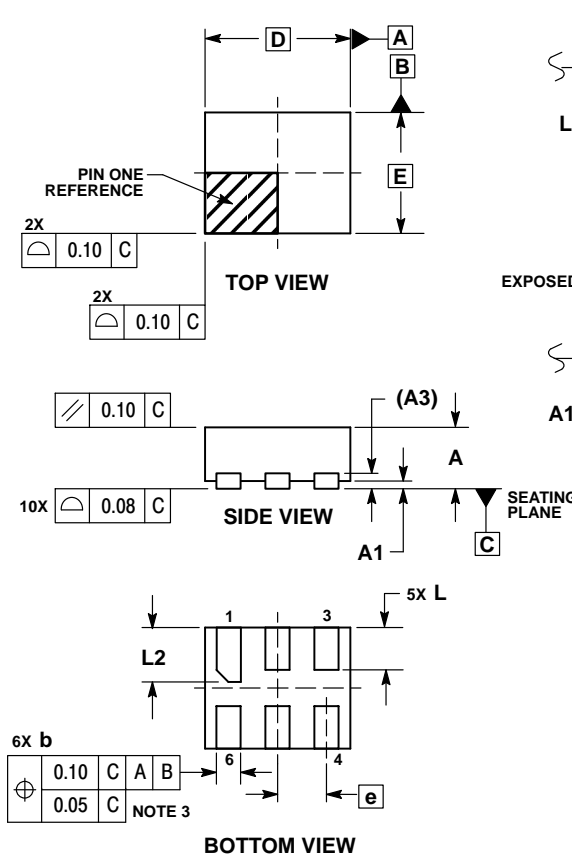

- NOTES:
1. DIMENSIONING AND TOLERANCING PER ASME Y14.5M, 1994.
  2. CONTROLLING DIMENSION: MILLIMETERS.
  3. DIMENSION b APPLIES TO PLATED TERMINAL AND IS MEASURED BETWEEN 0.25 AND 0.30 mm FROM TERMINAL.
  4. COPLANARITY APPLIES TO THE EXPOSED PAD AS WELL AS THE TERMINALS.

| DIM | MILLIMETERS |      |
|-----|-------------|------|
|     | MIN         | MAX  |
| A   | 0.45        | 0.55 |
| A1  | 0.00        | 0.05 |
| A3  | 0.127       | REF  |
| b   | 0.15        | 0.25 |
| D   | 1.20        | BSC  |
| E   | 1.00        | BSC  |
| e   | 0.40        | BSC  |
| L   | 0.30        | 0.40 |
| L1  | 0.00        | 0.15 |
| L2  | 0.40        | 0.50 |

### MOUNTING FOOTPRINT\*

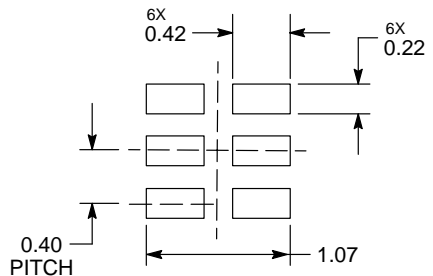

DIMENSIONS: MILLIMETERS

\*For additional information on our Pb-Free strategy and soldering details, please download the ON Semiconductor Soldering and Mounting Techniques Reference Manual, SOLDERRM/D.

# NLU2G14

## PACKAGE DIMENSIONS

UDFN6 1.45x1.0, 0.5P  
CASE 517AQ  
ISSUE O

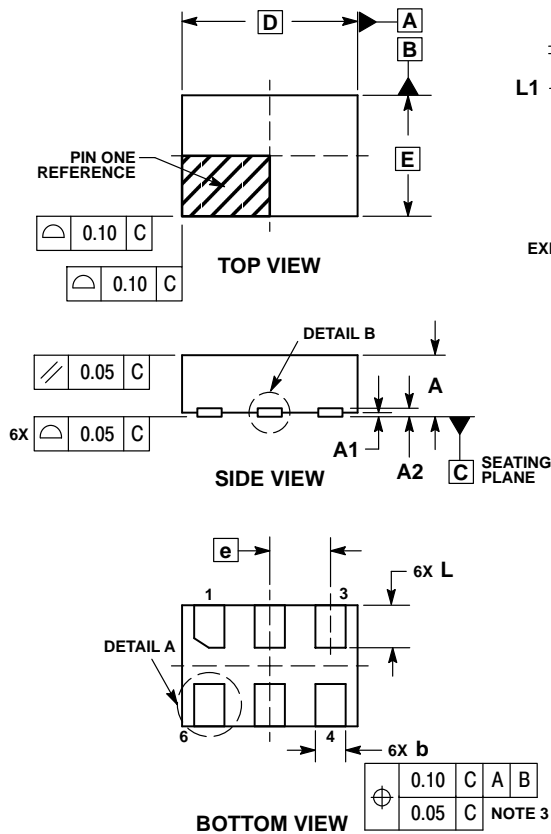

**NOTES:**

1. DIMENSIONING AND TOLERANCING PER ASME Y14.5M, 1994.
2. CONTROLLING DIMENSION: MILLIMETERS.
3. DIMENSION b APPLIES TO PLATED TERMINAL AND IS MEASURED BETWEEN 0.15 AND 0.30 mm FROM THE TERMINAL TIP.

| DIM | MILLIMETERS |      |
|-----|-------------|------|
|     | MIN         | MAX  |
| A   | 0.45        | 0.55 |
| A1  | 0.00        | 0.05 |
| A2  | 0.07 REF    |      |
| b   | 0.20        | 0.30 |
| D   | 1.45 BSC    |      |
| E   | 1.00 BSC    |      |
| e   | 0.50 BSC    |      |
| L   | 0.30        | 0.40 |
| L1  | — 0.15      |      |

**MOUNTING FOOTPRINT**

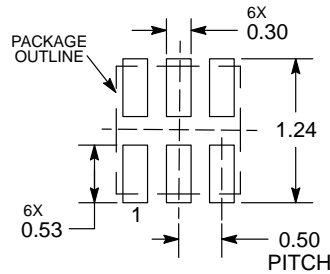

DIMENSIONS: MILLIMETERS

\*For additional information on our Pb-Free strategy and soldering details, please download the ON Semiconductor Soldering and Mounting Techniques Reference Manual, SOLDERRM/D.

MiniGate is a trademark of Semiconductor Components Industries, LLC (SCILLC).

ON Semiconductor and are trademarks of Semiconductor Components Industries, LLC dba ON Semiconductor or its subsidiaries in the United States and/or other countries. ON Semiconductor owns the rights to a number of patents, trademarks, copyrights, trade secrets, and other intellectual property. A listing of ON Semiconductor's product/patent coverage may be accessed at [www.onsemi.com/site/pdf/Patent-Marketing.pdf](http://www.onsemi.com/site/pdf/Patent-Marketing.pdf). ON Semiconductor reserves the right to make changes without further notice to any products herein. ON Semiconductor makes no warranty, representation or guarantee regarding the suitability of its products for any particular purpose, nor does ON Semiconductor assume any liability arising out of the application or use of any product or circuit, and specifically disclaims any and all liability, including without limitation special, consequential or incidental damages. Buyer is responsible for its products and applications using ON Semiconductor products, including compliance with all laws, regulations and safety requirements or standards, regardless of any support or applications information provided by ON Semiconductor. "Typical" parameters which may be provided in ON Semiconductor data sheets and/or specifications can and do vary in different applications and actual performance may vary over time. All operating parameters, including "Typicals" must be validated for each customer application by customer's technical experts. ON Semiconductor does not convey any license under its patent rights nor the rights of others. ON Semiconductor products are not designed, intended, or authorized for use as a critical component in life support systems or any FDA Class 3 medical devices or medical devices with a same or similar classification in a foreign jurisdiction or any devices intended for implantation in the human body. Should Buyer purchase or use ON Semiconductor products for any such unintended or unauthorized application, Buyer shall indemnify and hold ON Semiconductor and its officers, employees, subsidiaries, affiliates, and distributors harmless against all claims, costs, damages, and expenses, and reasonable attorney fees arising out of, directly or indirectly, any claim of personal injury or death associated with such unintended or unauthorized use, even if such claim alleges that ON Semiconductor was negligent regarding the design or manufacture of the part. ON Semiconductor is an Equal Opportunity/Affirmative Action Employer. This literature is subject to all applicable copyright laws and is not for resale in any manner.

**PUBLICATION ORDERING INFORMATION**

**LITERATURE FULFILLMENT:**

Literature Distribution Center for ON Semiconductor  
P.O. Box 5163, Denver, Colorado 80217 USA  
Phone: 303-675-2175 or 800-344-3860 Toll Free USA/Canada  
Fax: 303-675-2176 or 800-344-3867 Toll Free USA/Canada  
Email: [orderlit@onsemi.com](mailto:orderlit@onsemi.com)

**N. American Technical Support:** 800-282-9855 Toll Free  
USA/Canada  
**Europe, Middle East and Africa Technical Support:**  
Phone: 421 33 790 2910  
**Japan Customer Focus Center**  
Phone: 81-3-5817-1050

**ON Semiconductor Website:** [www.onsemi.com](http://www.onsemi.com)  
**Order Literature:** <http://www.onsemi.com/orderlit>

For additional information, please contact your local Sales Representative

## Looking for pricing, stock, or lifecycle information?

Click below to explore more details on WIN SOURCE:

 [View NLU2G14MUTCG on WIN SOURCE](#)

 [ON Semiconductor](#) Information

## Optimize Your Supply Chain with WIN SOURCE Solutions

-  Global Sourcing Solution
-  Obsolete Management
-  Cost Control Management
-  Shortage Management
-  Alternative Solution
-  Excess Inventory Management