



**THE DATASHEET OF
RACM60-12SK/OF/PCB-T**



Features

Regulated Converter

- Input Range: 80-264VAC or 80-305VAC
- Temperature rang: -40 to +85°C with derating
- Over voltage category OVC III
- 2MOPP medical certified B and BF compliant
- Class B EMC filter built-in
- 4000/5000m (medical/ITE) operating altitude



RACM60-K

60 Watt



Open Frame

2"x3" & 2"x4"

Enclosed 2"x4"



Description

The multi-purpose, industrial + household + medical grade AC/DC converter series RACM60-K/OF delivers 60 Watts of output power from -40°C to +55°C with natural air convection only, and up to +85°C with derating or forced cooling. With a clear focus on extended thermal performance for systems where space is limited, these 2" x 3" compact modules are designed to gain highest overall efficiency levels over the full output load range from universal AC inputs. The RACM60-K/OF has ANSI/AAMI/IEC 60601-1 medical safety and EN 60601-1-2 medical EMC certifications and offers 4kVAC/1 min isolation, 2MOPP and designed to meet B and BF requirements. It is additionally certified to IEC/EN62368-1(CB Report) and IEC61558-1/-2-16 for industrial applications and IEC/EN60335-1 for household appliances. The robust built-in Class B EMC filter has sufficient margin to allow both Installation Class II or Class I PELV with grounded output. A range of mechanical fixing options makes the RACM60 suitable for many different mounting conditions: the standard chassis mount part mates with Molex connectors and the /PCB option permits direct installation in printed circuit boards. Additionally, a 2" x 4" footprint for backwards-compatibility with legacy designs is available on request.

Selection Guide

Part Number	Input Voltage Range [VAC]	Output Voltage [VDC]	Output Current [mA]	Output Power [W]	Efficiency typ. (1) [%]
RACM60-05SK (2,3,4)	80-264/ 80-305	5	8000	40	89
RACM60-12SK (2,3,4)	80-264/ 80-305	12	5000	60	90
RACM60-15SK (2,3,4)	80-264/ 80-305	15	4000	60	90
RACM60-24SK (2,3,4)	80-264/ 80-305	24	2500	60	90
RACM60-36SK (2,3)	80-264	36	1667	60	90
RACM60-48SK (2,3,4)	80-264/ 80-305	48	1250	60	90

Notes:

Note1: Efficiency is tested at nominal input and full load at +25°C ambient

Model Numbering

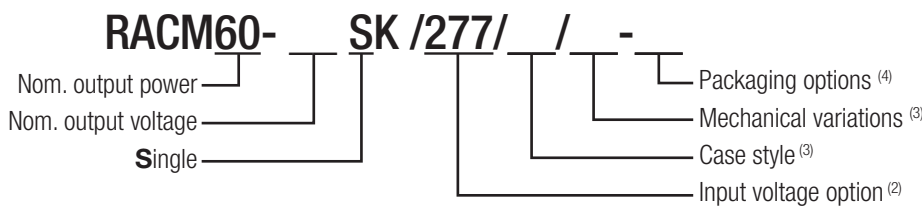

Notes:

Note2: Add suffix "/277/OF" for wider input voltage range (80-305VAC)

Without suffix= standard input range (80-264VAC), check "Model Matrix (4)"

For more information, refer to "Input Voltage Range (5,6)"

Note3: "/OF" = standard 2"x3" open frame version with standard connectors

"/OF/PCB" = 2"x3" open frame with PCB mounting pins

"/OF/2x4" = 2"x4" open frame version with standard connectors

"/ENC/2x4" = 2"x4" version with metal enclosure and standard connectors (coming soon)

Note4: for packaging details refer to last page "PACKAGING INFORMATION"

Model Matrix (4)

Model	/OF	/277/OF	/OF/PCB	/OF/2x4	/ENC/2x4
RACM60-05SK	x	x	x	on request	on request
RACM60-12SK	x	x	x	x	x
RACM60-15SK	x	x	on request	on request	on request
RACM60-24SK	x	x	x	x	x
RACM60-36SK	x	on request	on request	on request	on request
RACM60-48SK	x	x	on request	on request	on request

x = standard portfolio / on request = MOQ may apply on project base / N/A= not available



IEC/EN62368-1 certified
 UL1310 pending, NEC Class 2 (12/24SK/OF)
 ANSI/AAMI ES60601-1 Ed. 3.1 certified
 CSA/CAN-C22.2 No. 60601-1:14 certified
 IEC/EN60335-1 certified
 IEC/EN61558-1 certified
 IEC/EN61558-2-16 certified
 EN60601-1-2 compliant
 EN55032 compliant
 EN55035 compliant
 CB Report

Specifications (measured @ Ta= 25°C, nom. Vin, full load and after warm-up unless otherwise stated)

BASIC CHARACTERISTICS

Parameter	Condition		Min.	Typ.	Max.
Internal Input Filter			Pi Type		
Nominal Input Voltage	50/60Hz	standard version "/277" version	100VAC		240VAC 277VAC
Input Voltage Range ^(5,6)	standard version	47-63Hz DC	80VAC 120VDC		264VAC 370VDC
	"/277" version	47-63Hz DC	80VAC 120VDC		305VAC 430VDC
Input Current	115VAC 230VAC 277VAC				1400mA 600mA 500mA
Inrush Current	cold start	115VAC 230VAC 277VAC			30A 60A 70A
ErP Standby Mode Conformity (Output Load Capability)	115/230/277VAC	Input Power:	0.5W 1.0W	0.3W 0.7W	
No load Power Consumption	230VAC 277VAC			100mW 120mW	
Input Frequency Range	AC Input		47Hz		63Hz
Minimum Load			0%		
Power Factor	115VAC 230VAC 277VAC		0.6 0.5 0.45		
Start-up Time				150ms	
Rise Time				100ms	
Hold-up Time	115VAC 230VAC 277VAC		12ms 50ms 70ms		
Internal Operating Frequency	100% load at nominal Vin			100kHz	
Output Ripple and Noise ⁽⁷⁾	20MHz BW	5Vout others			200mVp-p 1% of Vout

Notes:

- Note5: The products were submitted for safety files at AC-Input operation (90-264VAC)
- Note6: Output power derating for Line-input of less than 90VAC (derate linearly from 100% at 90VAC to 80% at 80VAC)
- Note7: Measurements are made with a 0.1µF MLCC & 10µF E-cap in parallel across output. (low ESR)

Efficiency vs. Load

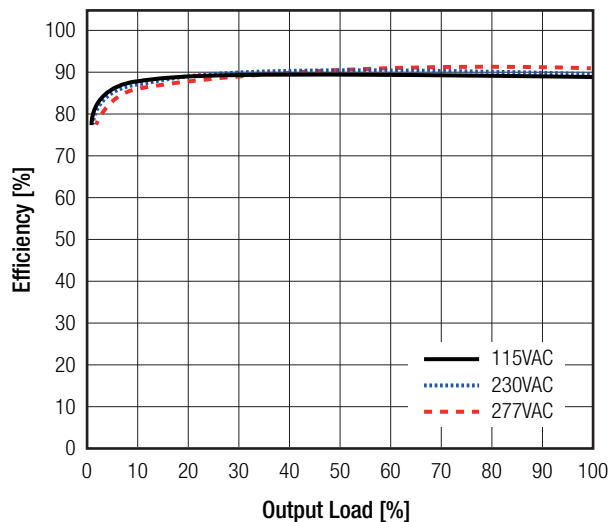

Specifications (measured @ Ta= 25°C, nom. Vin, full load and after warm-up unless otherwise stated)

REGULATIONS			
Parameter	Condition		Value
Output Accuracy	standard version		100% load ±2.0% typ.
	"/277" version		5Vout others ±3.0% typ. ±1.0% typ.
Line Regulation	standard version		low line to high line ±0.05% typ.
	"/277" version		5Vout others ±0.5% typ. ±0.05% typ.
Load Regulation ⁽⁸⁾	standard version	10% to 100% load	5VDC 12VDC, 15VDC 24VDC, 36VDC, 48VDC ±1.5% typ. ±0.5% typ. ±0.1% typ.
	"/277" version	10% to 100% load	5VDC 12VDC, 15VDC 24VDC, 36VDC, 48VDC ±3.0% typ. ±0.8% typ. ±0.2% typ.
Transient Response	25% load step change		3.0% max.
	recovery time		500µs max.

Notes:

Note8: Operation below 10% load will not harm the converter, but specifications may not be met

Deviation vs. Load

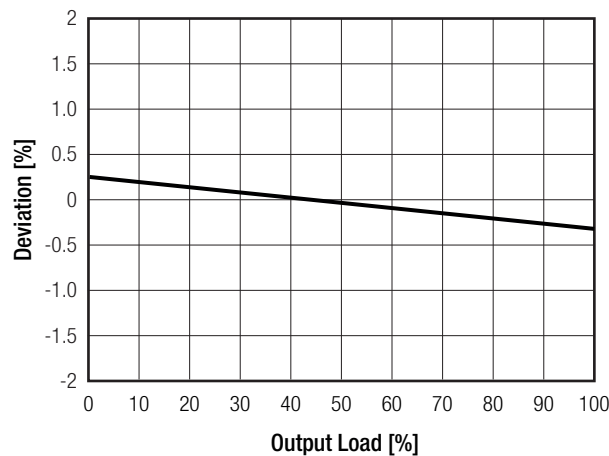

PROTECTIONS		
Parameter	Type	Value
Input Fuse	internal	T3.15A, slow blow type
Short Circuit Protection (SCP)		hiccup, auto recovery
Over Voltage Protection (OVP)		105 - 120%, auto recovery
Output Reverse Voltage Protection		107 - 145%, auto recovery
Over Voltage Category (OVC) ⁽⁹⁾	according to 62368-1, 61558-2-16 & 60335-1	OVC II
	according to 61558-2-16	OVC III (up to 2000m)
Over Current Protection (OCP)		130% - 180%, hiccup mode
Thermal Shutdown	TC point IC 101	+130°C, restart after cool down

Notes:

Note9: RACM60-xxK/277/OF models were submitted to safety agency for OVC III rating.

continued on next page

Specifications (measured @ Ta= 25°C, nom. Vin, full load and after warm-up unless otherwise stated)

Parameter	Type		Value
Class of Equipment			Class II
Isolation Voltage (safety certified) ⁽¹⁰⁾	1 minute	I/P to O/P; according to 61558-2-16, 60601-1	4.2kVAC
Isolation Resistance	I/P to O/P, V _{ISO} = 500VDC		1GΩ min.
Isolation Capacitance	I/P to O/P, 100kHz/0.1V		100pF max.
Insulation Grade			reinforced
Means of Protection	319VAC working voltage		2MOPP

Notes:

Note10: For repeat Hi-Pot testing, reduce the time and/or the test voltage

ENVIRONMENTAL

Parameter	Condition		Value
Operating Temperature Range	@ natural convection 0.1m/s	refer to graphs below	-40°C to +85°C
Temperature Coefficient			±0.02%/K
Operating Altitude ⁽¹¹⁾	according to 62368-1, 61558-2-16 & 60335-1		5000m
	according to 60601-1		4000m
Operating Humidity	non-condensing		95% max.
Pollution Degree			PD2
Vibration	according to MIL-STD-202G		10-500Hz, 2G 10min./1cycle, period 60min. along x,y,z axes
MTBF	according to MIL-HDBK-217F, G.B.	+25°C	>900 x 10 ³ hours
		+40°C	>726 x 10 ³ hours
Design Lifetime	nom. Vin= 230VAC	+40°C	>42 x 10 ³ hours

Notes:

Note11: Recognized by safety agency for safe operation up to 4000/5000m. High altitude operation may impact the performance and lifetime
Please contact RECOM tech support for advice

Derating Graph non-/277/0F Versions

(@ Chamber and natural convection 0.1m/s)

Output power derating for line-input of less than 90VAC (derate linearly from 100% at 90VAC to 80% at 80VAC)

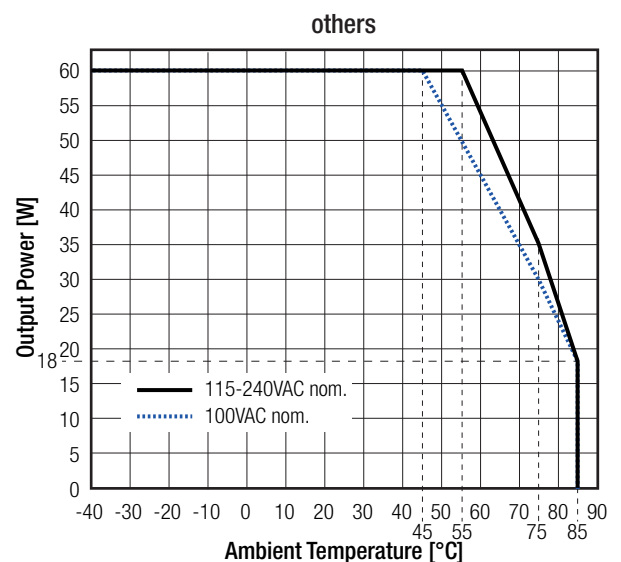
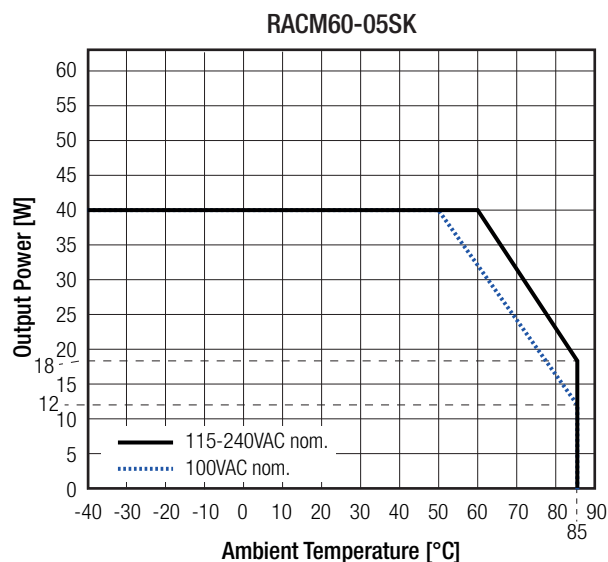

continued on next page

Specifications (measured @ Ta= 25°C, nom. Vin, full load and after warm-up unless otherwise stated)

Derating Graph “/277/OF” Version

(@ Chamber and natural convection 0.1m/s)

Output power derating for Line-input of less than 90VAC (derate linearly from 100% at 90VAC to 80% at 80VAC)

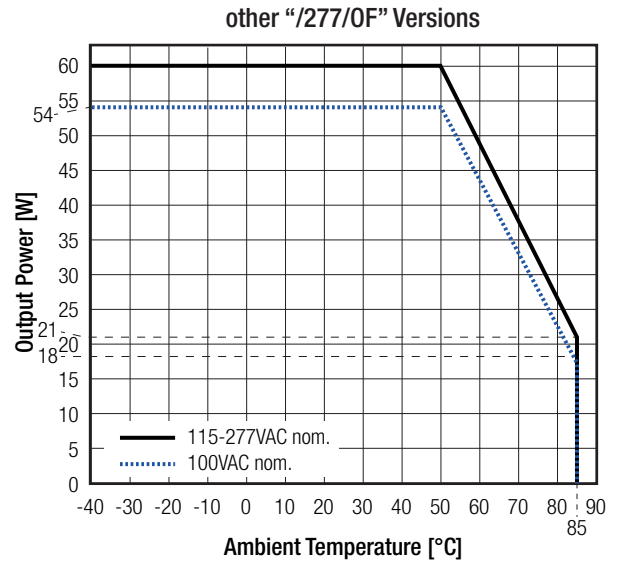
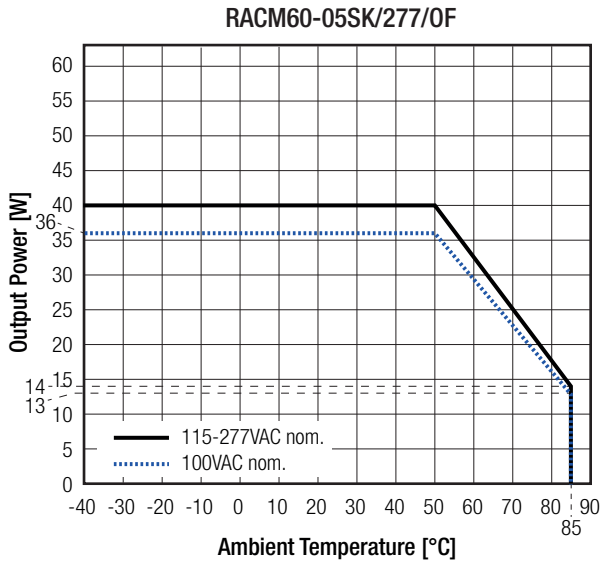

SAFETY AND CERTIFICATIONS

Certificate Type (Safety)	Report Number	Standard
Medical electrical equipment Part 1: General requirements for basic safety and essential performance	E511305-D1000-1/A1/C0-UL	CAN/CSA-C22.2 No. 60601-1:14, 3rd Ed. ANSI/AAMI ES60601-1:2005 + A2:2010/R2012
Audio/Video, information and communication technology equipment - Safety requirements (CB Scheme)	CN21PMDW-001	IEC62368-1:2014 2nd Edition
Audio/Video, information and communication technology equipment - Safety requirements (LVD)	50355749 001	EN62368-1:2014 + A11:2017
Household and similar electrical appliances – Safety – Part 1: General requirements (LVD)	4384104.50	IEC60335-1:2010 5th Edition + A2:2016 EN60335-1:2012 + A15:2021
Standard for Class 2 Power Units (TÜV)	pending (RACM60-12SK/OF, RACM60-24SK/OF only)	UL1310:2018 + R:2020-06
Safety of power transformers, power supplies, reactors & similar products for supply voltages up to 1100 V (CB Scheme)	50355750 001 (except /277/OF & /ENC/2x4)	IEC61558-1:2005 2nd Edition + A1:2009
Safety of power transformers, power supplies, reactors & similar products for supply voltages up to 1100 V Part 2: Particular requirements (CB Scheme)		IEC61558-2-16:2009 1st Edition + A1:2013
Safety of power transformers, power supplies, reactors & similar products for supply voltages up to 1100V	50355751 001 (except /277/OF & /ENC/2x4)	EN61558-1:2005 + A1:2009
Safety of power transformers, power supplies, reactors & similar products for supply voltages up to 1100 V Part 2: Particular requirements		EN61558-2-16:2009 + A1:2013
Safety of power transformers, power supplies, reactors and similar products for supply voltages up to 1100 V (CB Scheme)	085-210569701-000 (OVCIll)	IEC61558-1:2017
Safety of power transformers, power supplies, reactors and similar products for supply voltages up to 1100 V Part 2: Particular requirements (CB Scheme)		IEC61558-2-16:2009 1st Edition + A1:2013
Safety of power transformers, power supplies, reactors and similar products for supply voltages up to 1100 V	64.210.21.05697.01 (OVCIll)	EN IEC 61558-1:2019
Safety of power transformers, power supplies, reactors and similar products for supply voltages up to 1100 V Part 2: Particular requirements		EN61558-2-16:2009 + A1:2013

continued on next page

Specifications (measured @ Ta= 25°C, nom. Vin, full load and after warm-up unless otherwise stated)

EMC Compliance (EN60601-1-2)	Condition	Standard / Criterion
Medical electrical equipment - Part 1-2: General requirements for basic safety and essential performance - Collateral standard: Electromagnetic compatibility - Requirements and tests	LCS220321054BE	EN60601-1-2:2015+A1:2021 Class B, Group 1
ESD Electrostatic discharge immunity test	Air: ±2, 4, 8, 15kV Contact: ±2, 4, 8kV	EN61000-4-2:2009, Criteria B
Radiated, radio-frequency, electromagnetic field immunity test	9V/m (704-787MHz) 9V/m (5100-5800MHz) 10V/m (80-2700MHz) 27V/m (380-390MHz) 28V/m (430-470MHz) 28V/m (800-960MHz) 28V/m (1700-1990MHz) 28V/m (2400-2570MHz)	EN61000-4-3:2006+A2:2010, Criteria A
Fast Transient and Burst Immunity	AC Port: L-N 2kV	EN61000-4-4:2012, Criteria B
Surge Immunity	L-N: 1kV L (N)-PE: 2kV	EN61000-4-5:2014, Criteria B
Immunity to conducted disturbances, induced by radio-frequency fields	AC Port: 3Vrms: (0.15-80MHz) 6Vrms: (ISM and amateur radio bands according to table 9)	EN61000-4-6:2014, Criteria A
Power Magnetic Field Immunity	30A/m	EN61000-4-8:2010, Criteria A
Voltage Dips and Interruptions	Dips: 100% (0.5P 1.0P) 30% Interruptions: 100%	EN61000-4-11:2004, Criteria B
Limits of Voltage Fluctuations & Flicker	LCS220321054BE	EN61000-3-3:2013
EMC Compliance (EN55032)	Condition	Standard / Criterion
Electromagnetic compatibility of multimedia equipment - Emission requirements	LCS220321053BE	EN55032:2015+A1:2020, Class B
Electromagnetic compatibility of multimedia equipment - Immunity requirements		EN55035:2017+A11:2020
ESD Electrostatic discharge immunity test	Air: ±2, 4, 8kV Contact: ±2, 4kV	EN61000-4-2:2009, Criteria B
Radiated, radio-frequency, electromagnetic field immunity test	3 V/m (80-5000MHz)	EN61000-4-3:2006+A2:2010, Criteria A
Fast Transient and Burst Immunity	AC Port: L-N 1kV	EN61000-4-4:2004+A1:2010, Criteria B
Surge Immunity	L-N: 1kV L (N)-PE: 2kV	EN61000-4-5:2014 + A1:2017, Criteria B
Immunity to conducted disturbances, induced by radio-frequency fields	AC Port: 3Vrms (0.15-10MHz) 3-1Vrms (10-30MHz) 1Vrms (30-80MHz)	EN61000-4-6:2014+A1:2015, Criteria A
Power Magnetic Field Immunity	1A/m	EN61000-4-8:2010, Criteria A
Voltage Dips and Interruptions	Dips: 100% 30% Interruptions:100%	EN61000-4-11:2004+A1:2017, Criteria B EN61000-4-11:2004+A1:2017, Criteria C EN61000-4-11:2004+A1:2017, Criteria C
Limits of Voltage Fluctuations & Flicker	LCS220321053BE	EN61000-3-3:2013
EMC Compliance (EN61204-3)	Condition	Standard / Criterion
Low voltage power supplies, d.c. output Part 3: Electromagnetic compatibility (EMC)	LCS220321055BE	EN/IEC61204-3:2018, Class B
ESD Electrostatic discharge immunity test	Air: ±2, 4, 8kV Contact: ±2, 4kV	EN61000-4-2:2009, Criteria B

continued on next page

Specifications (measured @ Ta= 25°C, nom. Vin, full load and after warm-up unless otherwise stated)

EMC Compliance (EN61204-3)	Condition	Standard / Criterion
Radiated, radio-frequency, electromagnetic field immunity test	10V/m (80-1000MHz) 3V/m (1400-2000MHz) 1V/m (2000-2700MHz)	EN61000-4-3:2006+A2:2010, Criteria A
Fast Transient and Burst Immunity	AC Port: L-N 2kV	EN61000-4-4:2012, Criteria B
Surge Immunity	L-N: 1kV L (N)-PE: 2kV	EN61000-4-5:2014 + A1:2017, Criteria B
Immunity to conducted disturbances, induced by radio-frequency fields	AC Port: 10Vrms (0.15-80MHz)	EN61000-4-6:2014+A1:2015, Criteria A
Power Magnetic Field Immunity	30A/m	EN61000-4-8:2010, Criteria A
Voltage Dips and Interruptions	Dips: 100% (0.5P, 1.0P)	EN61000-4-11:2004 +A1:2017, Criteria B
	30% or 20%	EN61000-4-11:2004 +A1:2017, Criteria B
	Interruptions:100%	EN61000-4-11:2004 +A1:2017, Criteria C
Limits of Voltage Fluctuations & Flicker	LCS220321055BE	EN61000-3-3:2013+A2:2021
Limitations on the amount of electromagnetic interference allowed from digital and electronic devices	WTD22D04060199E	FCC 47 CFR Part 15:2020 Subpart B
Limitations on the amount of electromagnetic interference allowed from digital and electronic devices, industrial, scientific, and medical equipment	WTD22D04060215E	FCC 47 CFR Part 18:2020

DIMENSION AND PHYSICAL CHARACTERISTICS

Parameter	Type	Value
Material	PCB	FR4 (UL94-V0)
Dimension (LxWxH)	"/OF" and type	78.4 x 53.0 x 31.5mm
	"/277/OF" type	76.2 x 50.8 x 32.0mm
	"/OF/PCB" type	78.4 x 53.0 x 35.4mm
	"/OF/2x4" type	101.6 x 53.0 x 31.5mm
	"/ENC/2x4" type	118.3 x 62.7 x 38.7mm
Weight	"/OF"; "/277/OF" and "/OF/PCB" types	111g typ.
	"/OF/2x4" type	120g typ.
	"/ENC/2x4" type	167g typ.

continued on next page

Specifications (measured @ Ta= 25°C, nom. Vin, full load and after warm-up unless otherwise stated)

Dimension Drawing "/OF" (mm)

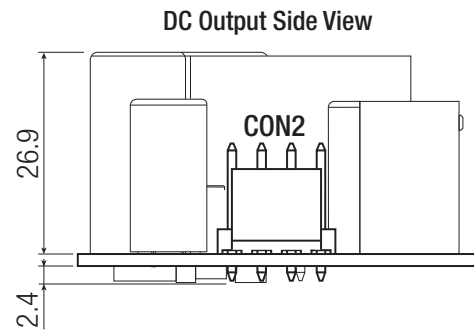
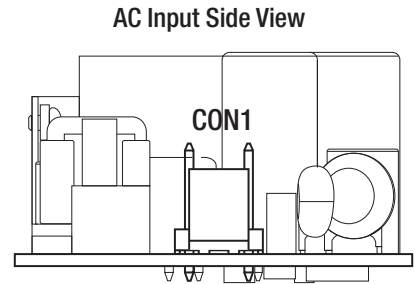
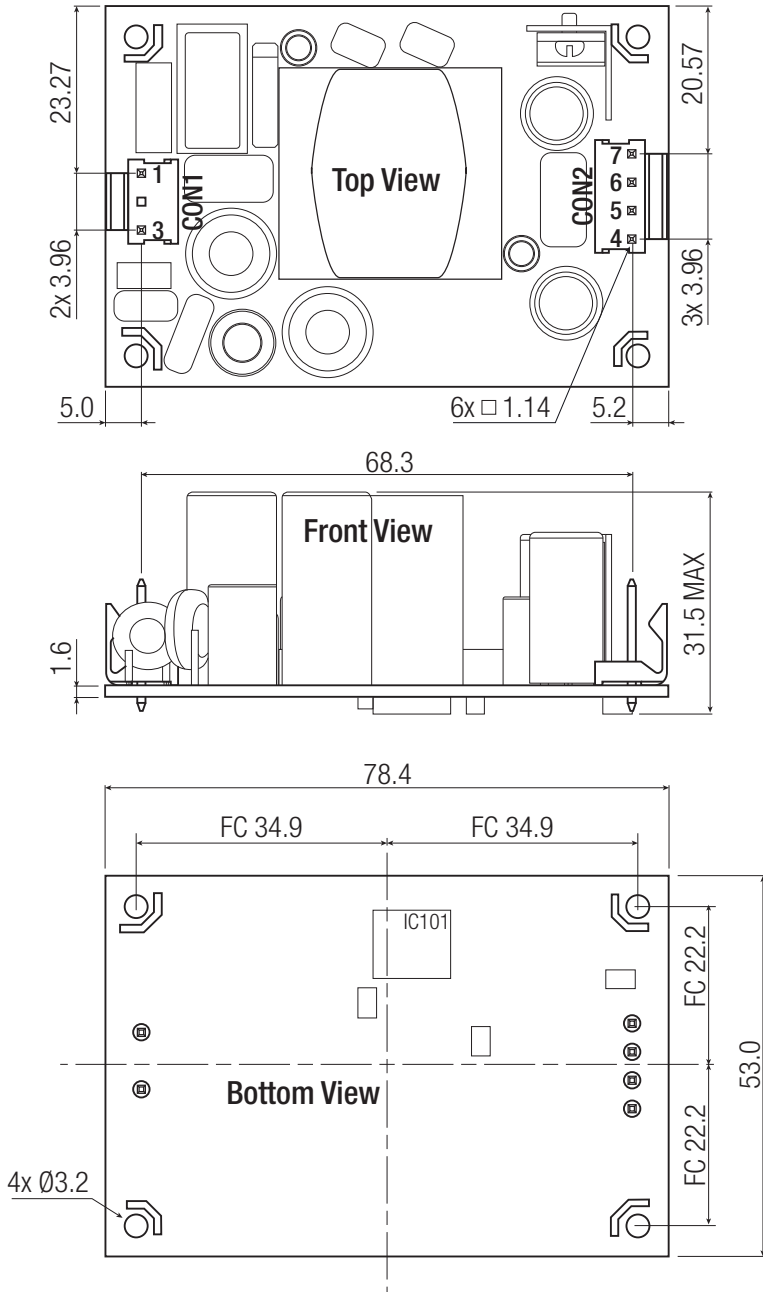

Connector Information

#	Function	Terminal
AC Input (CON1)		
1	VAC in (N)	3 Pins (Pin2 removed)
3	VAC in (L)	with 3.96mm pitch
DC Output (CON2)		
4,5	-VDC out	4 Pins
6,7	+VDC out	with 3.96mm pitch

FC= fixing centers

Compatible Connector

Housing

Molex 41695 Series or equivalent

Crimp Terminal

Molex 2478 Series or equivalent

General tolerances according to ISO 2768-m (table for reference only)

Dimension range	Tolerances
0.5 - 6 mm	±0.1 mm
6 - 30 mm	±0.2 mm
30 - 120 mm	±0.3 mm
120 - 400 mm	±0.5 mm

continued on next page

Specifications (measured @ Ta= 25°C, nom. Vin, full load and after warm-up unless otherwise stated)

Dimension Drawing "277/OF" (mm)

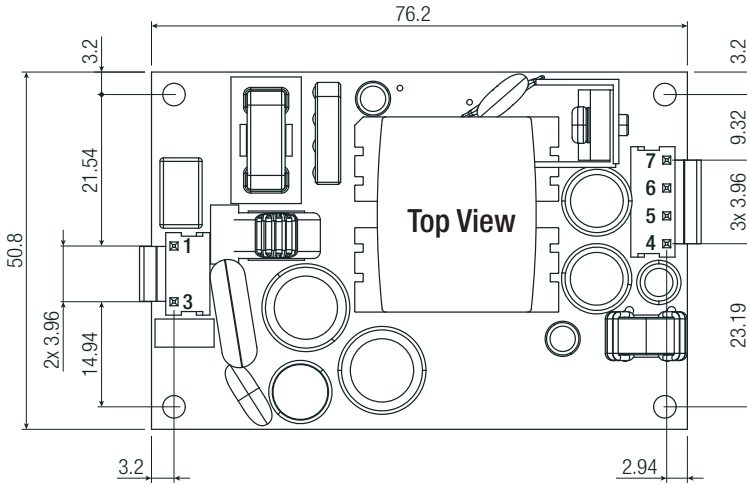

AC Input Side View

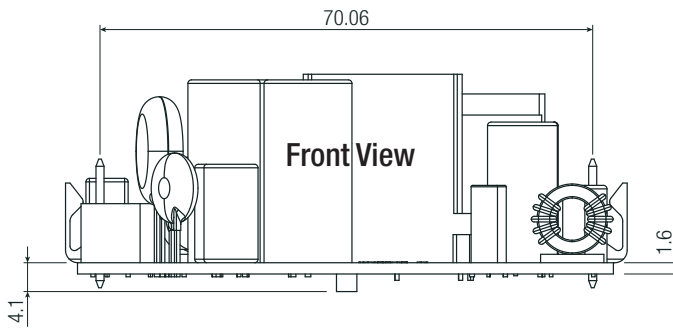
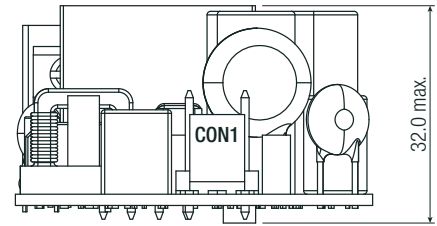

DC Output Side View

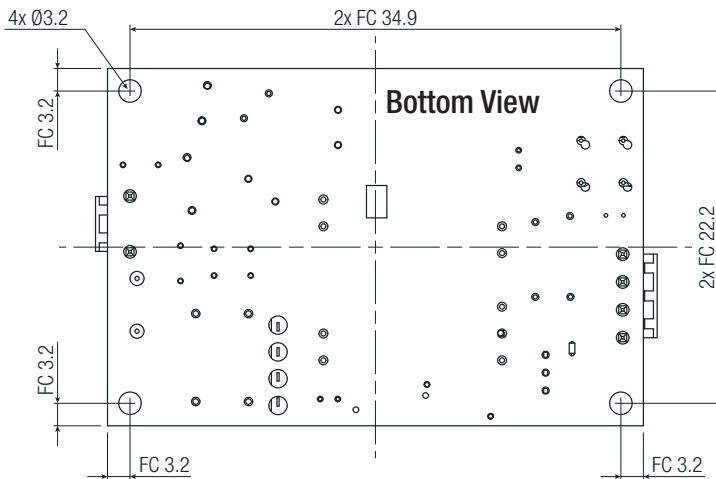
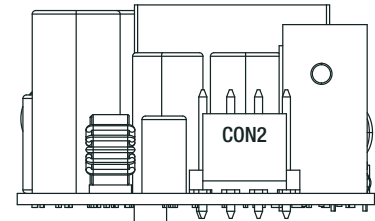

Connector Information

#	Function	Terminal
AC Input (CON1)		
1	VAC in (N)	3 Pins (Pin2 removed)
3	VAC in (L)	with 3.96mm pitch
DC Output (CON2)		
4,5	-VDC out	4 Pins
6,7	+VDC out	with 3.96mm pitch

FC= fixing centers

Compatible Connector

Housing

Molex 41695 Series or equivalent

Crimp Terminal

Molex 2478 Series or equivalent

General tolerances according to ISO 2768-m (table for reference only)

Dimension range	Tolerances
0.5 - 6 mm	±0.1 mm
6 - 30 mm	±0.2 mm
30 - 120 mm	±0.3 mm
120 - 400 mm	±0.5 mm

continued on next page

Specifications (measured @ Ta= 25°C, nom. Vin, full load and after warm-up unless otherwise stated)

Dimension Drawing "/OF/2x4" (mm)

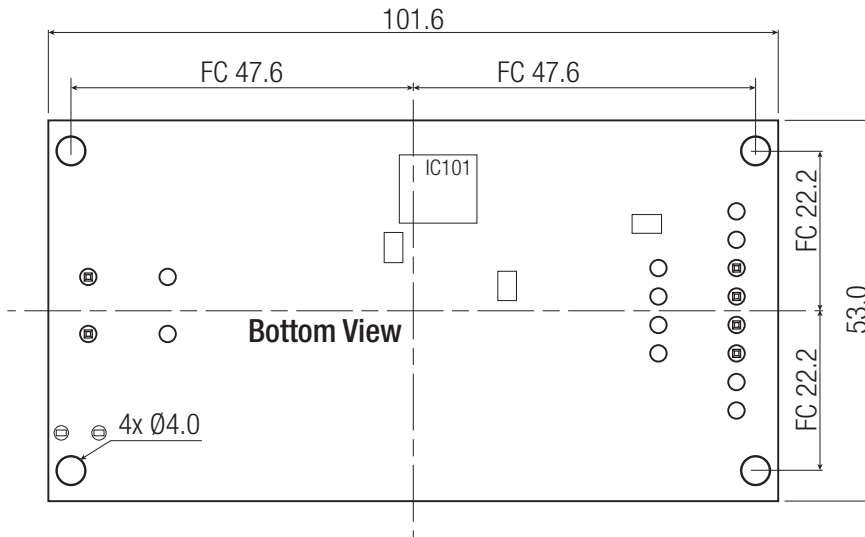
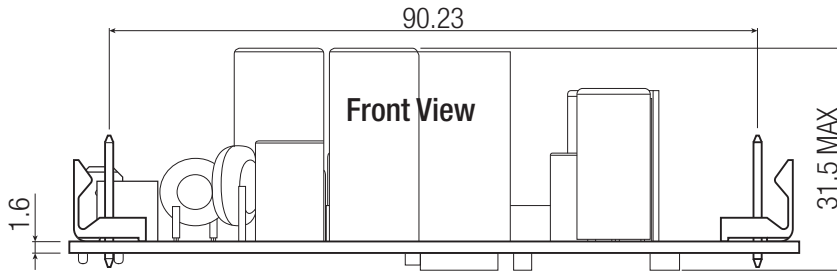
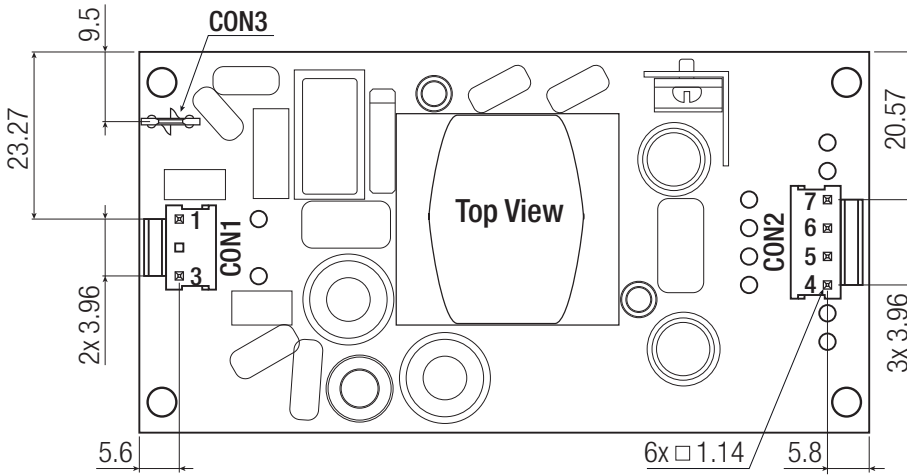

AC Input Side View

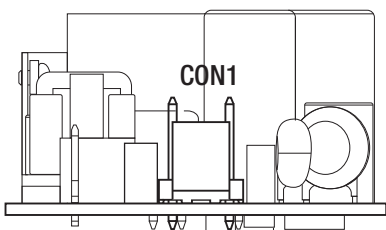

DC Output Side View

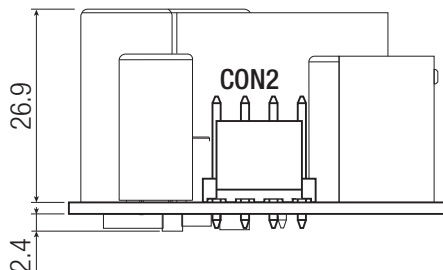

Connector Information

#	Function	Terminal
AC Input (CON1)		
1	VAC in (N)	3 Pins (Pin2 removed)
3	VAC in (L)	with 3.96mm pitch
DC Output (CON2)		
4,5	-VDC out	4 Pins
6,7	+VDC out	with 3.96mm pitch
FE (CON3)		
8	functional earth	fast on

FC= fixing centers
Compatible connector please refer to "/OF" drawing)

Compatible Connector

- Housing**
Molex 41695 Series or equivalent
- Crimp Terminal**
Molex 2478 Series or equivalent

General tolerances according to ISO 2768-m (table for reference only)

Dimension range	Tolerances
0.5 - 6 mm	±0.1 mm
6 - 30 mm	±0.2 mm
30 - 120 mm	±0.3 mm
120 - 400 mm	±0.5 mm

continued on next page

Specifications (measured @ Ta= 25°C, nom. Vin, full load and after warm-up unless otherwise stated)

Dimension Drawing "/OF/PCB" (mm)

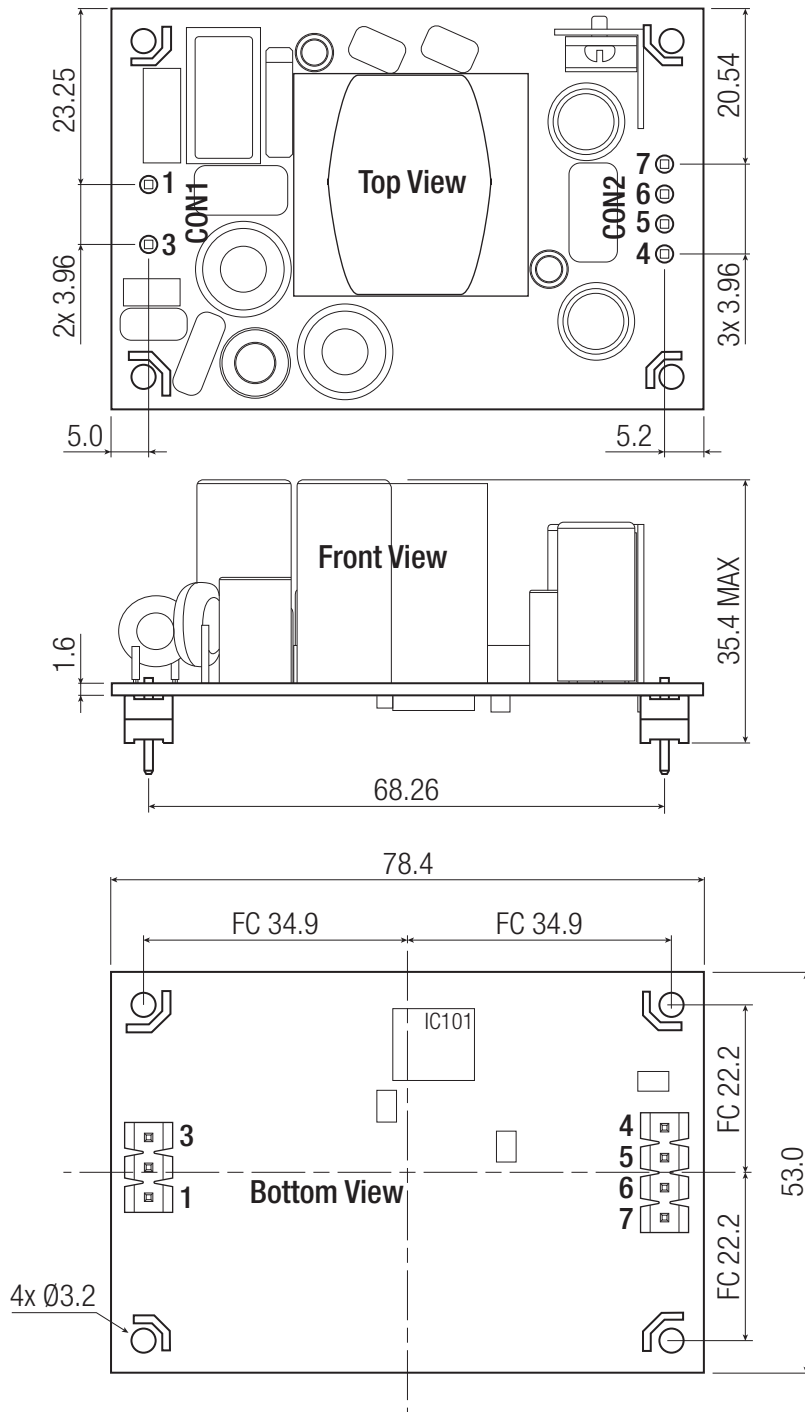

Pin-header Information

#	Function	Terminal
AC Input (CON1)		
1	VAC in (N)	3 Pins (Pin2 removed)
3	VAC in (L)	with 3.96mm pitch
DC Output (CON2)		
4,5	-VDC out	4 Pins
6,7	+VDC out	with 3.96mm pitch

Color of the connector may alternatively appear black or white related to the batch of production

General tolerances according to ISO 2768-m (table for reference only)

Dimension range	Tolerances
0.5 - 6 mm	±0.1 mm
6 - 30 mm	±0.2 mm
30 - 120 mm	±0.3 mm
120 - 400 mm	±0.5 mm

Specifications (measured @ Ta= 25°C, nom. Vin, full load and after warm-up unless otherwise stated)

Dimension Drawing "/ENC" (mm)

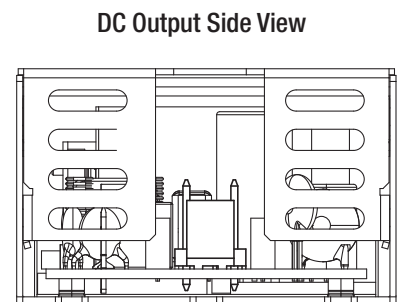
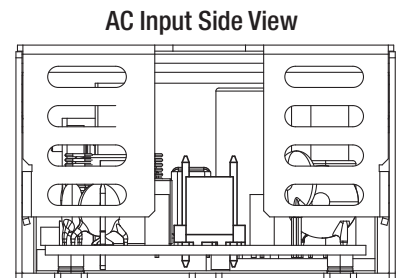
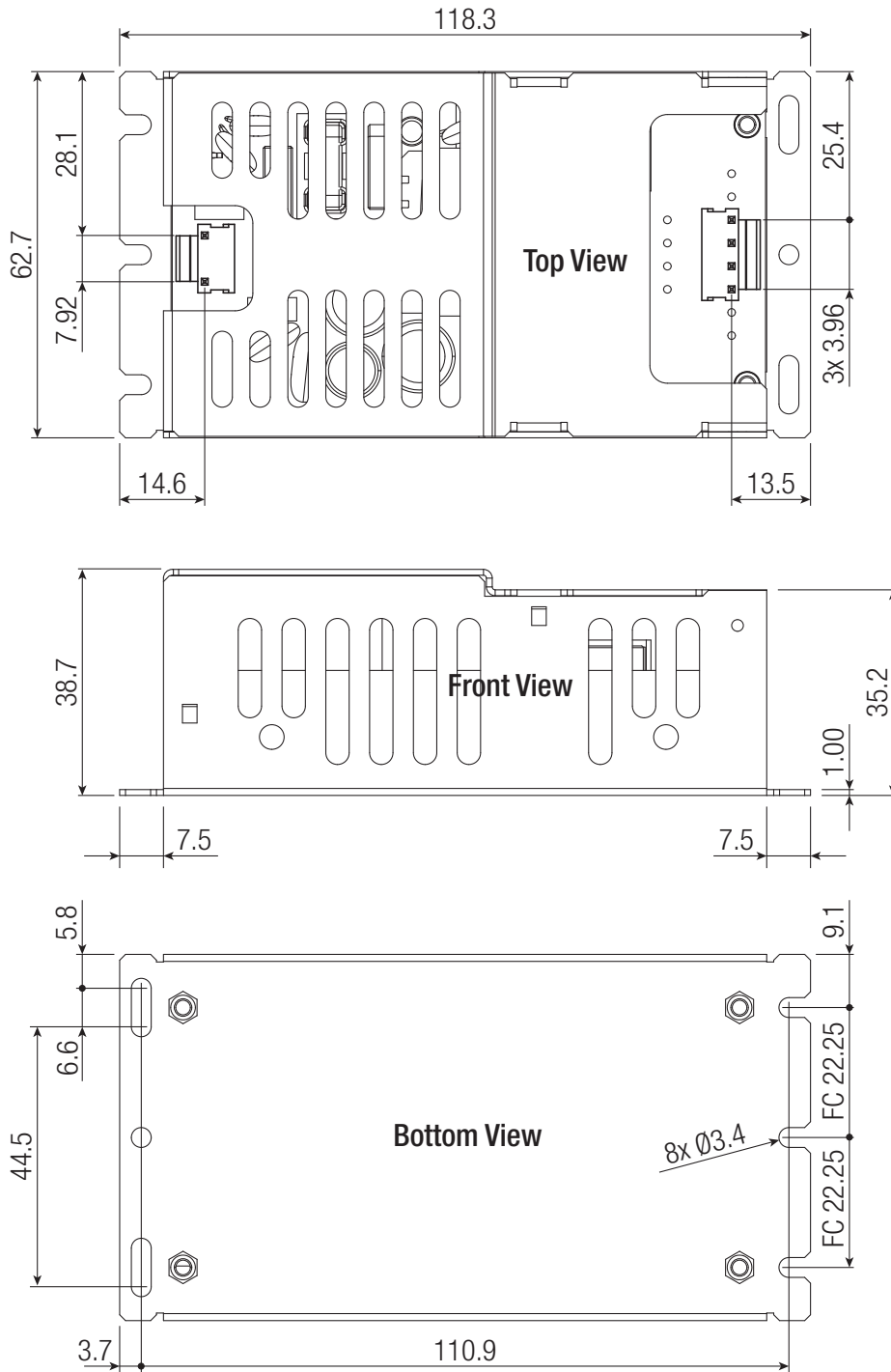

General tolerances according to ISO 2768-m (table for reference only)

Dimension range	Tolerances
0.5 - 6 mm	±0.1 mm
6 - 30 mm	±0.2 mm
30 - 120 mm	±0.3 mm
120 - 400 mm	±0.5 mm

Connector Information

#	Function	Terminal
AC Input (CON1)		
1	VAC in (N)	3 Pins (Pin2 removed)
3	VAC in (L)	with 3.96mm pitch
DC Output (CON2)		
4,5	-VDC out	4 Pins
6,7	+VDC out	with 3.96mm pitch

FC= fixing centers

Specifications (measured @ Ta= 25°C, nom. Vin, full load and after warm-up unless otherwise stated)

APPLICATION AND INSTALLATION

Mounting

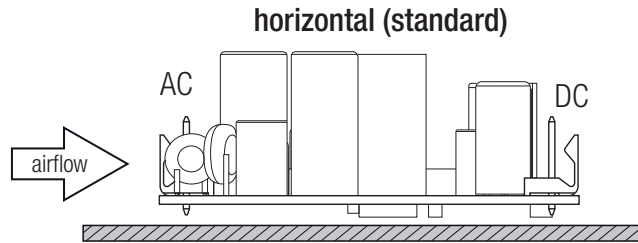
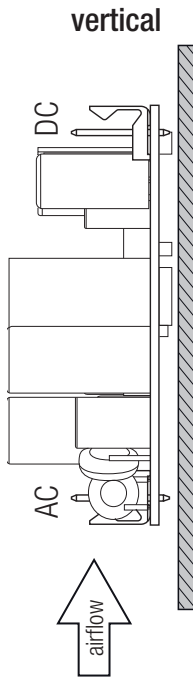

If module is mounted vertical or upside-down with natural convection cooling, the power must be derated $\geq 10\%$.

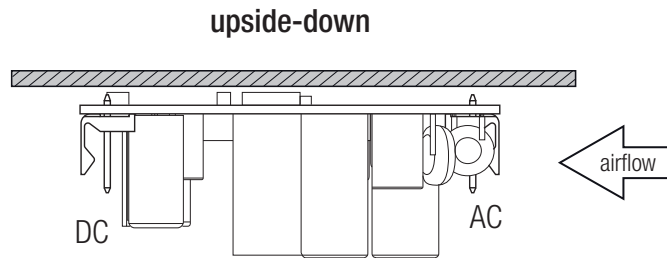

Blockdiagram (“/OF”, “/277/OF” and “/OF/PCB”)

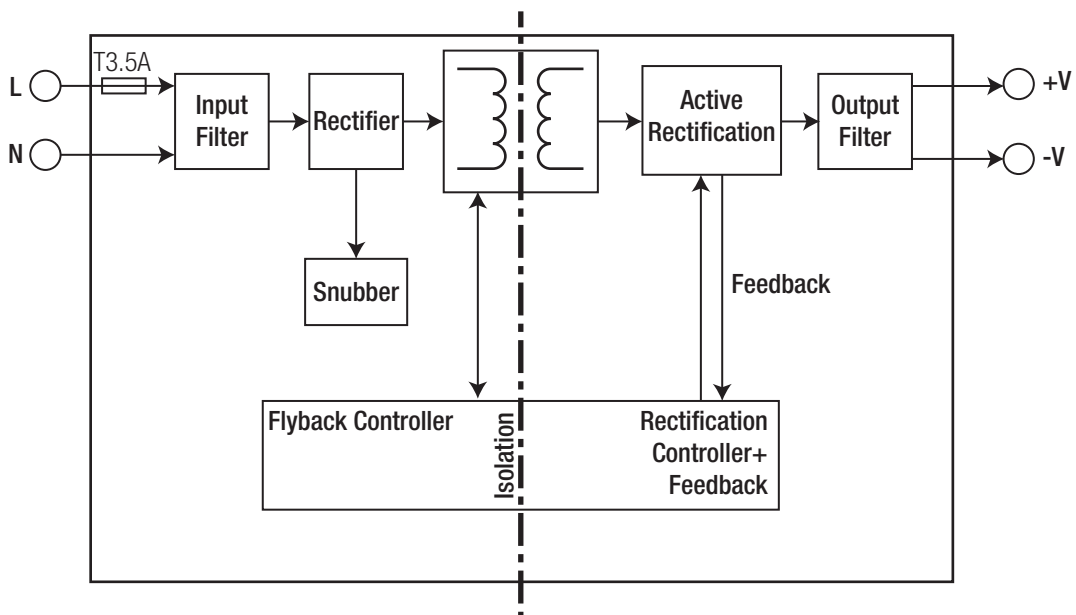

continued on next page

Specifications (measured @ Ta= 25°C, nom. Vin, full load and after warm-up unless otherwise stated)

APPLICATION AND INSTALLATION

Blockdiagram (“/OF/2x4”)

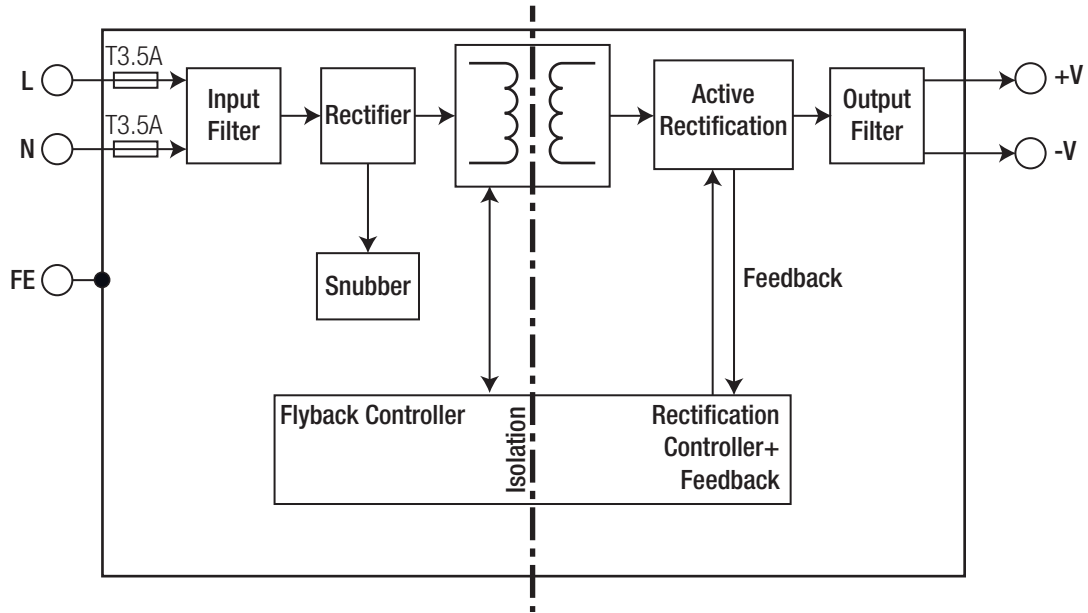

Blockdiagram (“/ENC/2x4”)

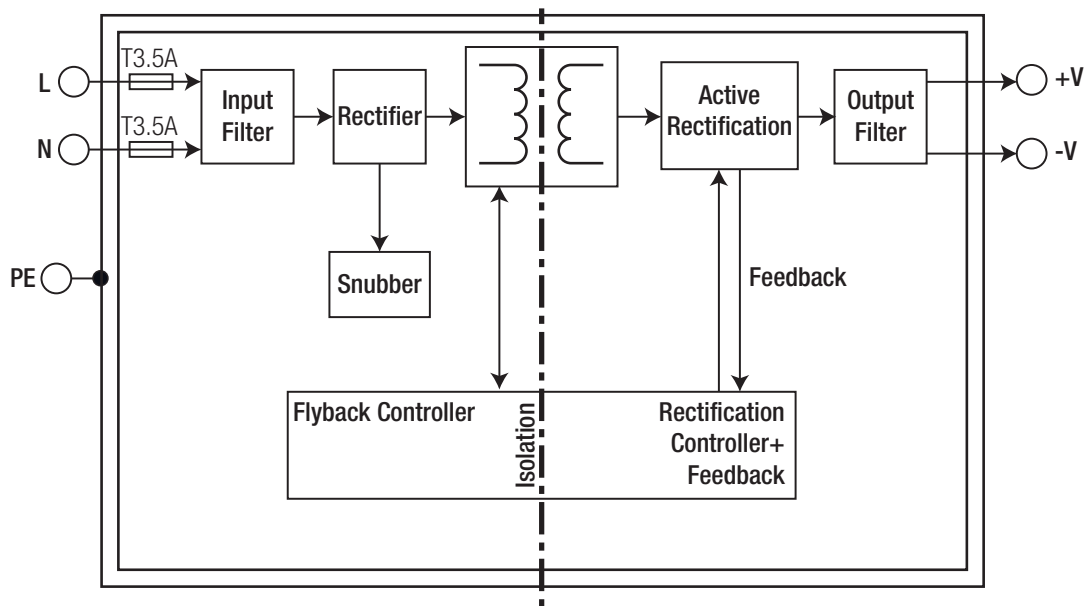

Specifications (measured @ Ta= 25°C, nom. Vin, full load and after warm-up unless otherwise stated)

PACKAGING INFORMATION

Parameter	Type		Value
Packaging Dimension (LxWxH)	"/OF" type	cardboard box (single pack)	65.0 x 55.0 x 95.0mm
	"/OF/2x4" type		65.0 x 50.0 x 110.0mm
	"/277/OF-T" type	single tray (carton)	215.0 x 365.0 x 62.0mm
	"/OF/PCB-T" type		365.0 x 210.0 x 56.0mm
	"/ENC/2x4" type		405.0 x 360.0 x 85.0mm
	"/OF-CTN" type	tray in carton (project pack)	375.0 x 220.0 x 245.0mm
Package Unit	"/OF" type and "/OF/2x4" type		1pcs
	"/277/OF-T" and "/OF/PCB-T" type		12pcs
	"/ENC/2x4" type		18pcs
	"/OF-CTN" type, MOQ= 1152pcs		48pcs
Storage Temperature Range			-40°C to +90°C
Storage Humidity	non-condensing		95% max.



ORDERING EXAMPLE

Model-number	Output Voltage	Input Range	Size	Type	Connection	Quantity	Packaging Type
RACM60-05SK/OF	5Vout	80-264VAC	2" x 3"	open frame	standard connector	1pc	cardboard box
RACM60-24SK/OF/PCB-T	24Vout	80-264VAC	2" x 3"	open frame	PCB mounting pins	12pcs	tray
RACM60-12SK/OF/2x4	12Vout	80-264VAC	2" x 4"	open frame	standard connector	1pc	cardboard box
RACM60-05SK/277/OF-T	5Vout	80-305VAC	2" x 3"	open frame	standard connector	12pcs	tray
RACM60-24SK/ENC/2x4	24Vout	80-264VAC	2" x 4"	enclosed	standard connector	18pcs	tray
RACM60-12SK/OF-CTN	12Vout	80-264VAC	2" x 4"	open frame	standard connector	48pcs (MOQ= 1152pcs)	carton

The product information and specifications may be subject to changes even without prior written notice. The product has been designed for various applications; its suitability lies in the responsibility of each customer. The products are not authorized for use in safety-critical applications without RECOM's explicit written consent. A safety-critical application is an application where a failure may reasonably be expected to endanger or cause loss of life, inflict bodily harm or damage property. The applicant shall indemnify and hold harmless RECOM, its affiliated companies and its representatives against any damage claims in connection with the unauthorized use of RECOM products in such safety-critical applications.

Looking for pricing, stock, or lifecycle information?

Click below to explore more details on WIN SOURCE:

-  [View RACM60-12SK/OF/PCB-T on WIN SOURCE](#)
-  [Recom Power Information](#)

Optimize Your Supply Chain with WIN SOURCE Solutions

-  Global Sourcing Solution
-  Obsolete Management
-  Cost Control Management
-  Shortage Management
-  Alternative Solution
-  Excess Inventory Management