



# THE DATASHEET OF RUEF300K



# POLYSWITCH RESETTABLE DEVICES

## Radial-Leaded Devices

Littelfuse's PolySwitch radial-leaded products represent the most comprehensive and complete set of PPTC products available in the industry today.

- RGEF series for hold currents up to 14A
- RHEF series for flatter thermal derating and operating temperatures up to 125°C
- RUEF series for balance of voltage rating (30V) and hold current (up to 9A)
- RUSBF series for fast time-to-trip and low-resistance computer applications
- RXEF series for low hold currents (down to 50mA) and high voltage rating (up to 72V)
- RKEF series for balance of voltage rating (60V) and hold current (up to 5A)
- Now offering halogen free versions of all products

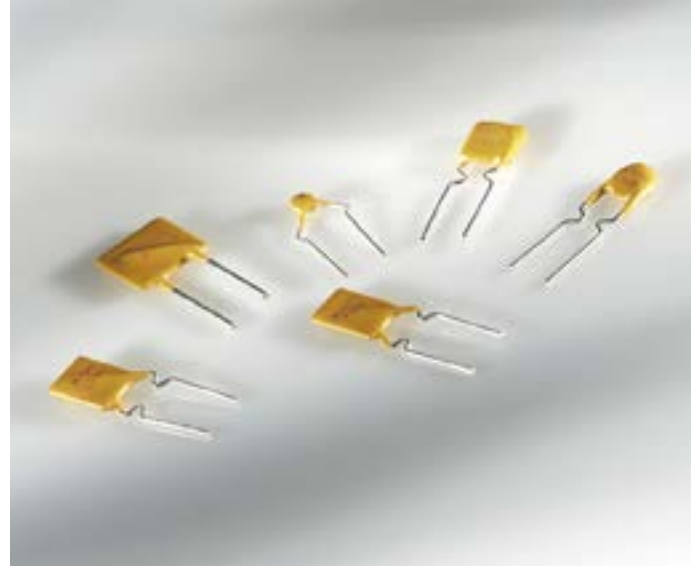

### BENEFITS

- Many product choices help provide engineers more design flexibility
- Compatible with high-volume electronics assembly
- Assists in meeting regulatory requirements
- Higher voltage ratings allow use in new applications

### FEATURES

- RoHS compliant
- Halogen free (refers to: Br $\geq$ 900ppm, Cl $\geq$ 900ppm, Br+Cl $\geq$ 1500ppm)
- Broadest range of radial-leaded resettable devices available in the industry
- Current ratings from 50mA to 15A
- Voltage ratings from 6V (computer and electronic applications) to 72V
- Agency recognition : UL, CSA, TÜV, CQC\*\*
- Fast time-to-trip
- Low resistance

\*\*CQC only applies to RXEF, RUEF family parts

### APPLICATIONS

- Satellite video receivers
- Industrial controls
- Transformers
- Modems
- CD-ROMs
- Game machines
- Phones
- Fax machines
- Analog and digital line cards
- Printers
- Intelligent appliance
- Robotic machine
- Power supply
- Security
- Lighting
- Medical application

# PolySwitch Resettable Devices

## Radial-Leaded Devices

### Application Selection Guide

The guide below lists PolySwitch radial-leaded devices that are typically used in each of the applications described.

Specifications for the suggested device part numbers can be found in this section.

Once a part number has been selected, the user should evaluate and test each product for its intended application.

Protection Application	PolySwitch Resettable Devices – Key Selection Criteria		
	Small Size	Flatter Derating	Lower Current Higher Voltage
Electromagnetic Loads	RGEF (<16V), RUEF (<30V)	RHEF (<16V)	RXEF (<72V), RKEF (<60V)
Halogen Lighting	RGEF (<16V), RUEF (<30V)	RHEF (<16V)	RXEF (<72V), RKEF (<60V)
Lighting Ballast	RXEF (<72V)		
Loudspeakers	RXEF (<72V)		RXEF (<72V), RKEF (<60V)
Medical Equipment	RGEF (<16V), RUEF (<30V)	RHEF (<16V)	RXEF (<72V), RKEF (<60V)
MOSFET Devices	RGEF (<16V), RUEF (<30V)	RHEF (<16V)	RXEF (<72V), RKEF (<60V)
Motors, Fans and Blowers	RXEF (<72V), RGEF (<16V)	RHEF (<16V)	
POS Equipment	RXEF (<72V), RUEF (<30V)		
Process and Industrial Controls	RXEF (<72V), RUEF (<30V)		
Satellite Video Receivers	RGEF (<16V), RUEF (<30V)	RHEF (<16V)	RXEF (<72V), RKEF (<60V)
Security and Fire Alarm Systems	RGEF (<16V), RUEF (<30V)	RHEF (<16V)	RXEF (<72V), RKEF (<60V)
Test and Measurement Equipment	RGEF (<16V), RUEF (<30V)	RHEF (<16V)	RXEF (<72V), RKEF (<60V)
Transformers	RGEF (<16V), RUEF (<30V)	RHEF (<16V)	RXEF (<72V), RKEF (<60V)
DDC Computer and Consumer Electronics	RUEF (<30V)		
Mouse and Keyboard	RUEF (<30V)		
SCSI	RUEF (<30V)		
USB	RUSBF (<16V)		
Traces and Printed Circuit Board Protection	RGEF (<16V), RUEF (<30V)	RHEF (<16V)	RXEF (<72V), RKEF (<60V)

**Note :** This list is not exhaustive. Littelfuse welcomes customer input for additional application ideas for PolySwitch resettable devices.

### Table R1 – Product Series - Current Rating, Voltage Rating/Typical Resistance

Voltage Rating	RXEF 72V	RKEF 60V	RXEF 60V	RUEF 30V	RGEF 16V	RHEF 16V	RHEF 30V	RUSBF 16V	RUSBF 6V
<b>Hold Current (A)</b>									
0.050	—	—	9.20Ω	—	—	—	—	—	—
0.100	—	—	3.50Ω	—	—	—	—	—	—
0.170	—	—	4.30Ω	—	—	—	—	—	—
0.200	2.290Ω	—	—	—	—	—	—	—	—
0.250	1.600Ω	—	—	—	—	—	—	—	—
0.300	1.110Ω	—	—	—	—	—	—	—	—
0.400	0.710Ω	—	—	—	—	—	—	—	—
0.500	0.640Ω	0.425Ω	—	—	—	—	0.68Ω	—	—
0.550	—	—	—	—	—	—	—	—	—
0.650	0.400Ω	0.350Ω	—	—	—	—	—	—	—
0.700	—	—	—	—	—	—	0.42Ω	—	—
0.750	0.325Ω	0.295Ω	—	—	—	—	—	—	0.140Ω
0.900	0.255Ω	0.255Ω	—	0.095Ω	—	—	—	0.100Ω	—
1.000	—	—	—	—	—	—	0.24Ω	—	—
1.100	0.200Ω	0.225Ω	—	0.075Ω	—	—	—	0.075Ω	—
1.200	—	—	—	—	—	—	—	—	0.080Ω
1.350	0.155Ω	0.165Ω	—	0.060Ω	—	—	—	0.060Ω	—
1.550	—	—	—	—	—	—	—	—	0.058Ω
1.600	0.115Ω	0.150Ω	—	0.050Ω	—	—	—	0.050Ω	—
1.850	0.100Ω	0.106Ω	—	0.045Ω	—	—	—	0.045Ω	—
1.900	—	—	—	—	—	—	—	—	—

# PolySwitch Resettable Devices

## Radial-Leaded Devices

Table R1 — Product Series - Current Rating, Voltage Rating/Typical Resistance (Cont'd)

Voltage Rating	RXEF 72V	RKEF 60V	RXEF 60V	RUEF 30V	RGEF 16V	RHEF 16V	RHEF 30V	RUSBF 16V	RUSBF 6V
<b>Hold Current (A)</b>									
2.000	—	—	—	—	—	0.0610Ω	—	—	—
2.500	0.065Ω	0.063Ω	—	0.030Ω	0.0380Ω	—	—	0.030Ω	—
3.000	0.050Ω	0.040Ω	—	0.035Ω	0.0514Ω	0.0430Ω	—	—	—
3.750	0.040Ω	0.029Ω	—	—	—	—	—	—	—
4.000	—	0.026Ω	—	0.020Ω	0.0300Ω	0.0320Ω	—	—	—
4.500	—	—	—	—	—	0.0290Ω	—	—	—
5.000	—	0.021Ω	—	0.020Ω	0.0192Ω	—	—	—	—
5.500	—	—	—	—	—	0.0200Ω	—	—	—
6.000	—	—	—	0.013Ω	0.0145Ω	0.0175Ω	—	—	—
6.500	—	—	—	—	—	0.0144Ω	—	—	—
7.000	—	—	—	0.013Ω	0.0105Ω	0.0132Ω	—	—	—
7.500	—	—	—	—	—	0.0120Ω	—	—	—
8.000	—	—	—	0.013Ω	0.0086Ω	0.0110Ω	—	—	—
9.000	—	—	—	0.008Ω	0.0070Ω	0.0100Ω	—	—	—
10.00	—	—	—	—	0.0056Ω	0.0083Ω	—	—	—
11.00	—	—	—	—	0.0050Ω	0.0073Ω	—	—	—
12.00	—	—	—	—	0.0046Ω	—	—	—	—
13.00	—	—	—	—	—	0.0055Ω	—	—	—
14.00	—	—	—	—	0.0040Ω	0.0050Ω	—	—	—
15.00	—	—	—	—	—	0.0050Ω	—	—	—

Table R2 — Thermal Derating [Hold Current (A) at Ambient Temperature (°C)]

Part Number	Maximum Ambient Temperature										
	-40°C	-20°C	0°C	20°C	25°C	40°C	50°C	60°C	70°C	85°C	125°C
<b>RXEF 60V</b>											
RXEF005	0.078	0.068	0.06	0.05	0.048	0.04	0.035	0.032	0.027	0.02	—
RXEF010	0.160	0.140	0.11	0.10	0.096	0.08	0.072	0.067	0.050	0.04	—
RXEF017	0.260	0.230	0.21	0.17	0.160	0.14	0.120	0.110	0.090	0.07	—
<b>RXEF 72V</b>											
RXEF020	0.31	0.27	0.24	0.20	0.19	0.16	0.14	0.13	0.11	0.08	—
RXEF025	0.39	0.34	0.30	0.25	0.24	0.20	0.18	0.16	0.14	0.10	—
RXEF030	0.47	0.41	0.36	0.30	0.29	0.24	0.22	0.20	0.16	0.12	—
RXEF040	0.62	0.54	0.48	0.40	0.38	0.32	0.29	0.25	0.22	0.16	—
RXEF050	0.78	0.68	0.60	0.50	0.48	0.41	0.36	0.32	0.27	0.20	—
RXEF065	1.01	0.88	0.77	0.65	0.62	0.53	0.47	0.41	0.35	0.26	—
RXEF075	1.16	1.02	0.89	0.75	0.72	0.61	0.54	0.47	0.41	0.30	—
RXEF090	1.40	1.22	1.07	0.90	0.86	0.73	0.65	0.57	0.49	0.36	—
RXEF110	1.71	1.50	1.31	1.10	1.06	0.89	0.79	0.69	0.59	0.44	—
RXEF135	2.09	1.84	1.61	1.35	1.30	1.09	0.97	0.85	0.73	0.54	—
RXEF160	2.48	2.18	1.90	1.60	1.54	1.30	1.15	1.01	0.86	0.64	—
RXEF185	2.87	2.52	2.20	1.85	1.78	1.50	1.33	1.17	1.00	0.74	—
RXEF250	3.88	3.40	2.98	2.50	2.40	2.03	1.80	1.58	1.35	1.00	—
RXEF300	4.65	4.08	3.57	3.00	2.88	2.43	2.16	1.89	1.62	1.20	—
RXEF375	5.81	5.10	4.46	3.75	3.60	3.04	2.70	2.36	2.03	1.50	—

# PolySwitch Resettable Devices

## Radial-Leaded Devices

Table R2 – Thermal Derating [Hold Current (A) at Ambient Temperature (°C)] (Cont'd)

Part Number	Maximum Ambient Temperature										
	-40°C	-20°C	0°C	20°C	25°C	40°C	50°C	60°C	70°C	85°C	125°C
<b>RKEF; 60V</b>											
RKEF050	0.73	0.65	0.58	0.50	0.48	0.42	0.38	0.34	0.31	0.26	—
RKEF065	0.94	0.85	0.75	0.65	0.63	0.54	0.50	0.44	0.40	0.34	—
RKEF075	1.09	0.98	0.86	0.75	0.73	0.62	0.58	0.51	0.46	0.39	—
RKEF090	1.30	1.17	1.04	0.90	0.87	0.75	0.69	0.61	0.55	0.47	—
RKEF110	1.60	1.43	1.27	1.10	1.06	0.92	0.85	0.75	0.67	0.57	—
RKEF135	1.96	1.76	1.55	1.35	1.31	1.12	1.04	0.92	0.83	0.71	—
RKEF160	2.32	2.08	1.84	1.60	1.55	1.33	1.23	1.08	0.98	0.83	—
RKEF185	2.68	2.41	2.13	1.85	1.79	1.54	1.43	1.26	1.13	0.96	—
RKEF250	3.63	3.25	2.88	2.50	2.43	2.08	1.93	1.70	1.52	1.31	—
RKEF300	4.35	3.90	3.45	3.00	2.91	2.50	2.30	2.04	1.84	1.55	—
RKEF375	5.44	4.88	4.31	3.75	3.64	3.11	2.90	2.54	2.29	1.94	—
RKEF400	5.80	5.20	4.60	4.00	3.88	3.32	3.08	2.73	2.45	2.08	—
RKEF500	7.25	6.50	5.75	5.00	4.85	4.15	3.85	3.41	3.06	2.59	—
<b>RUEF; 30V</b>											
RUEF090	1.31	1.17	1.04	0.90	0.87	0.75	0.69	0.61	0.55	0.47	—
RUEF110	1.60	1.43	1.27	1.10	1.07	0.91	0.85	0.75	0.67	0.57	—
RUEF135	1.96	1.76	1.55	1.35	1.31	1.12	1.04	0.92	0.82	0.70	—
RUEF160	2.32	2.08	1.84	1.60	1.55	1.33	1.23	1.09	0.98	0.83	—
RUEF185	2.68	2.41	2.13	1.85	1.79	1.54	1.42	1.26	1.13	0.96	—
RUEF250	3.63	3.25	2.88	2.50	2.43	2.08	1.93	1.70	1.53	1.30	—
RUEF300	4.35	3.90	3.45	3.00	2.91	2.49	2.31	2.04	1.83	1.56	—
RUEF400	5.80	5.20	4.60	4.00	3.88	3.32	3.08	2.72	2.44	2.08	—
RUEF500	7.25	6.50	5.75	5.00	4.85	4.15	3.85	3.40	3.05	2.60	—
RUEF600	8.70	7.80	6.90	6.00	5.82	4.98	4.62	4.08	3.66	3.12	—
RUEF700	10.15	9.10	8.05	7.00	6.79	5.81	5.39	4.76	4.27	3.64	—
RUEF800	11.60	10.40	9.20	8.00	7.76	6.64	6.16	5.44	4.88	4.16	—
RUEF900	13.05	11.70	10.35	9.00	8.73	7.47	6.93	6.12	5.49	4.68	—
<b>RHEF; 30V - High Temperature</b>											
RHEF050	0.68	0.62	0.56	0.51	0.50	0.44	0.40	0.36	0.34	0.28	0.12
RHEF070	0.95	0.87	0.79	0.72	0.70	0.62	0.56	0.51	0.47	0.39	0.17
RHEF100	1.36	1.24	1.13	1.03	1.00	0.89	0.80	0.73	0.67	0.56	0.24
<b>RUSBF; 16V</b>											
RUSBF090	1.31	1.17	1.04	0.90	0.87	0.75	0.69	0.61	0.55	0.47	—
RUSBF110	1.60	1.43	1.27	1.10	1.07	1.00	0.92	0.75	0.67	0.57	—
RUSBF135	1.96	1.76	1.55	1.35	1.31	1.12	1.04	0.92	0.82	0.70	—
RUSBF160	2.32	2.08	1.84	1.60	1.55	1.33	1.23	1.09	0.98	0.83	—
RUSBF185	2.68	2.41	2.13	1.85	1.79	1.54	1.42	1.26	1.13	0.96	—
RUSBF250	3.63	3.25	2.88	2.50	2.43	2.08	1.93	1.70	1.53	1.30	—
<b>RGEF; 16V</b>											
RGEF250	3.7	3.3	3.0	2.6	2.50	2.2	2.0	1.8	1.6	1.2	—
RGEF300	4.4	4.0	3.6	3.1	3.00	2.6	2.4	2.1	1.9	1.4	—
RGEF400	5.9	5.3	4.8	4.1	4.00	3.5	3.2	2.8	2.5	1.9	—
RGEF500	7.3	6.6	6.0	5.2	5.00	4.4	4.0	3.6	3.1	2.4	—
RGEF600	8.8	8.0	7.2	6.2	6.00	5.2	4.8	4.2	3.8	2.8	—
RGEF700	10.3	9.3	8.4	7.3	7.00	6.2	5.6	5.0	4.4	3.3	—
RGEF800	11.7	10.7	9.6	8.3	8.00	6.9	6.4	5.6	5.1	3.7	—

# PolySwitch Resettable Devices

## Radial-Leaded Devices

Table R2 – Thermal Derating [Hold Current (A) at Ambient Temperature (°C)] (Cont'd)

Part Number	Maximum Ambient Temperature										
	-40°C	-20°C	0°C	20°C	25°C	40°C	50°C	60°C	70°C	85°C	125°C
<b>RGEF; 16V</b>											
RGEF900	13.2	11.9	10.7	9.4	9.00	7.9	7.2	6.4	5.6	4.2	—
RGEF1000	14.7	13.3	12.0	10.3	10.00	8.7	8.0	7.0	6.3	4.7	—
RGEF1100	16.1	14.6	13.1	11.5	11.00	9.7	8.8	7.8	6.9	5.2	—
RGEF1200	17.6	16.0	14.4	12.4	12.00	10.4	9.6	8.4	7.6	5.6	—
RGEF1400	20.5	18.7	16.8	14.5	14.00	12.1	11.2	9.8	8.9	6.5	—
<b>RHEF; 16V - High Temperature</b>											
RHEF200	2.71	2.49	2.26	2.06	2.00	1.77	1.60	1.46	1.34	1.11	0.49
RHEF300	4.07	3.74	3.41	3.09	3.00	2.65	2.40	2.21	2.00	1.66	0.74
RHEF400	5.57	5.11	4.65	4.22	4.00	3.62	3.29	3.01	2.73	2.27	1.01
RHEF450	6.10	5.60	5.10	4.60	4.50	4.00	3.60	3.30	3.00	2.50	1.10
RHEF550	7.47	6.86	6.24	5.66	5.50	4.85	4.41	4.04	3.66	3.05	1.36
RHEF600	8.20	7.50	6.80	6.20	6.00	5.30	4.90	4.40	4.00	3.30	1.50
RHEF650	8.80	8.10	7.40	6.70	6.50	5.70	5.30	4.80	4.30	3.60	1.60
RHEF700	9.51	8.73	7.95	7.20	7.00	6.17	5.61	5.15	4.66	3.88	1.73
RHEF750	10.20	9.40	8.60	7.70	7.50	6.60	6.10	5.60	5.00	4.10	1.90
RHEF800	10.87	9.98	9.08	8.23	8.00	7.06	6.41	5.88	5.33	4.43	1.97
RHEF900	12.21	11.19	10.16	9.26	9.00	7.97	7.20	6.56	6.04	5.01	2.19
RHEF1000	13.60	12.50	11.40	10.30	10.00	8.80	8.10	7.40	6.60	5.50	2.50
RHEF1100	14.94	13.72	12.49	11.31	11.00	9.70	8.82	8.09	7.32	6.09	2.71
RHEF1300	17.70	16.30	14.80	13.40	13.00	11.40	10.50	9.60	8.60	7.20	3.30
RHEF1400	19.01	17.46	15.89	14.40	14.00	12.35	11.22	10.29	9.32	7.76	3.45
RHEF1500	20.40	18.80	17.10	15.50	15.00	13.20	12.10	11.10	9.90	8.30	3.80
<b>RUSBF; 6V</b>											
RUSBF075	1.05	0.95	0.85	0.75	0.73	0.65	0.60	0.55	0.50	0.43	—
RUSBF120	1.69	1.52	1.36	1.20	1.16	1.04	0.96	0.88	0.80	0.68	—
RUSBF155	2.17	1.96	1.75	1.55	1.50	1.34	1.24	1.14	1.03	0.88	—

## Figures R1-R5 – Thermal Derating Curve

RXEF

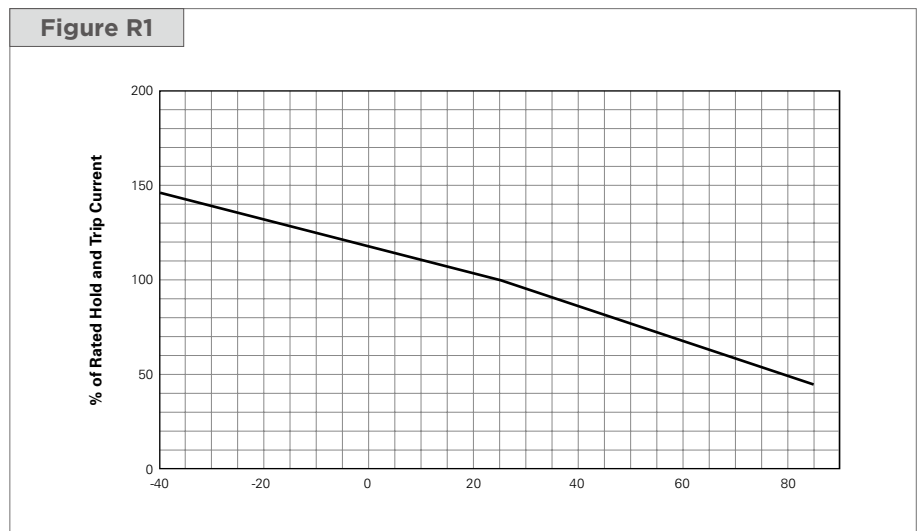

# PolySwitch Resettable Devices

## Radial-Leaded Devices

### Figures R1-R5 – Thermal Derating Curve

(Cont'd)

RKEF

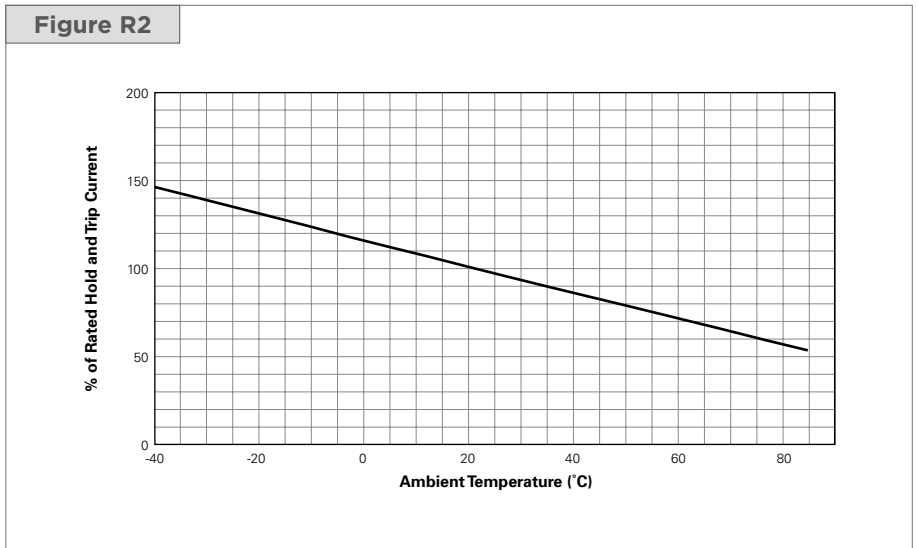

**A =** RUSBF075,  
RUSBF120,  
RUSBF155

**B =** RUEF,  
and all other RUSBF

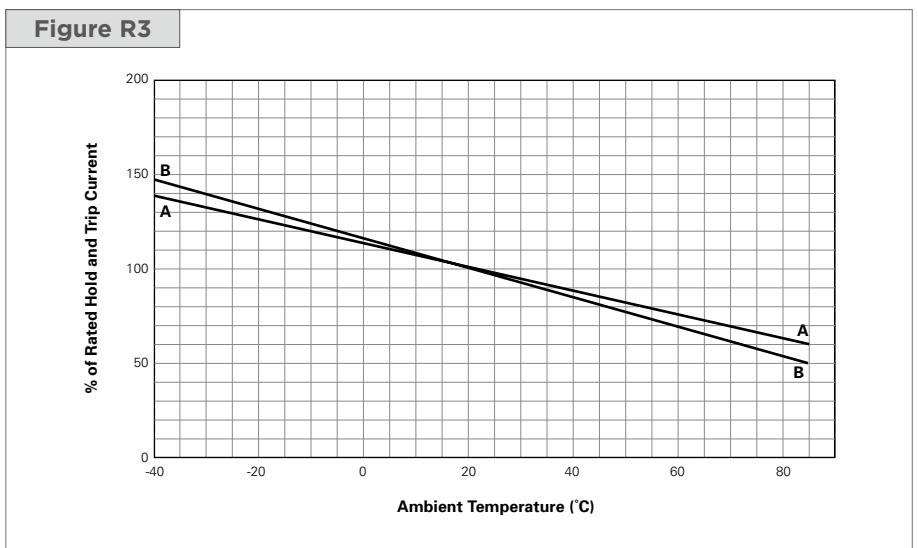

RHEF

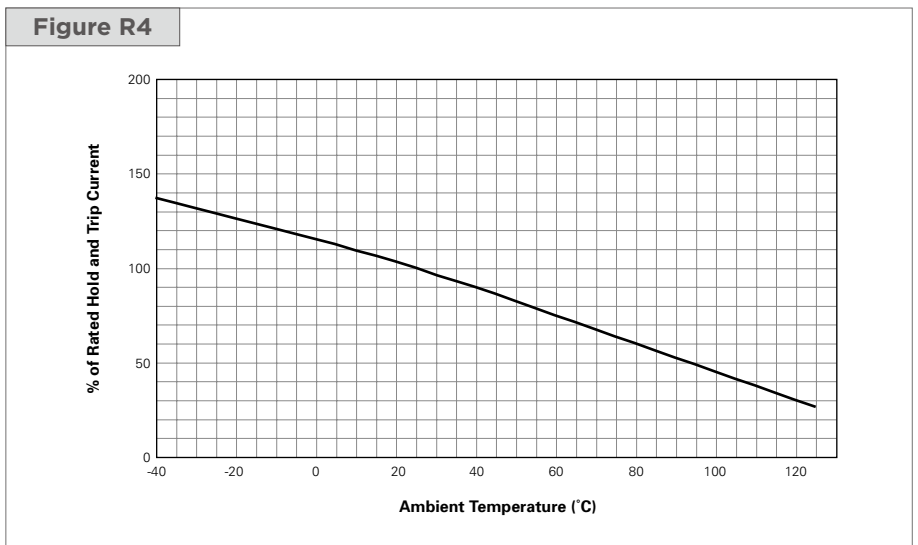

# PolySwitch Resettable Devices

## Radial-Leaded Devices

### Figures R1-R5 – Thermal Derating Curve

(Cont'd)

RGEF

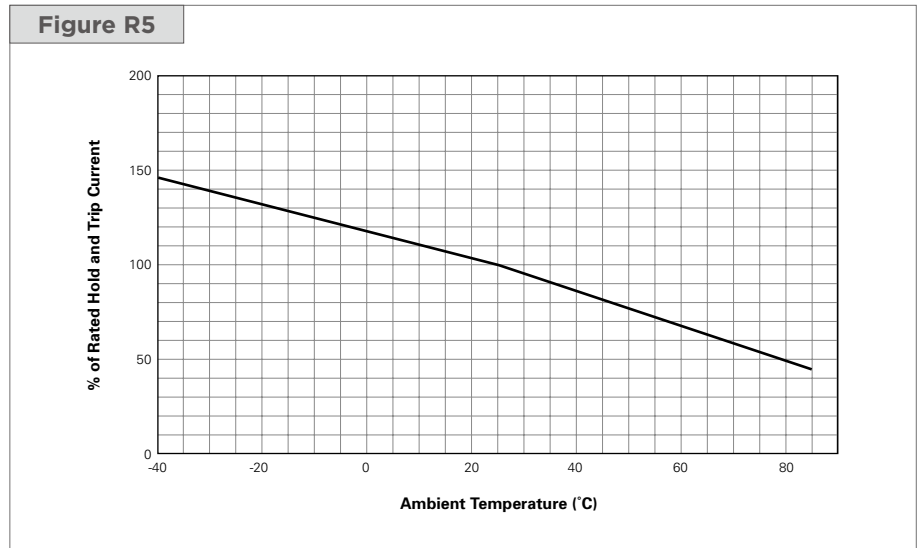

### Table R3 – Electrical Characteristics

Part Number	I <sub>H</sub> (A)	I <sub>T</sub> (A)	V <sub>MAX</sub>		I <sub>MAX</sub>		P <sub>D</sub> Typ (W)	Max Time-to-trip		R <sub>MIN</sub> (Ω)	R <sub>MAX</sub> (Ω)	R <sub>TMAX</sub> (Ω)	Lead Size [mm <sup>2</sup> (AWG)]
			(V <sub>DC</sub> )	(V <sub>AC RMS</sub> )	(DC <sub>ADC</sub> )	(AC <sub>ARMS</sub> )		(A)	(s)				
<b>RXEF</b>													
<b>60V</b>													
RXEF005	0.05	0.10	60	—	40	—	0.22	0.25	5.0	7.3	11.10	20.00	[0.128mm <sup>2</sup> (26)]
RXEF010	0.10	0.20	60	—	40	—	0.38	0.50	4.0	2.5	4.50	7.50	[0.205mm <sup>2</sup> (24)]
RXEF017	0.17	0.34	60	—	40	—	0.48	0.85	3.0	3.3	5.21	8.00	[0.205mm <sup>2</sup> (24)]
<b>RXEF</b>													
<b>72V</b>													
RXEF020	0.20	0.40	72	72	40	40	0.41	1.00	2.2	1.83	2.75	4.40	[0.205mm <sup>2</sup> (24)]
RXEF025	0.25	0.50	72	72	40	40	0.45	1.25	2.5	1.25	1.95	3.00	[0.205mm <sup>2</sup> (24)]
RXEF030	0.30	0.60	72	72	40	40	0.49	1.50	3.0	0.88	1.33	2.10	[0.205mm <sup>2</sup> (24)]
RXEF040	0.40	0.80	72	72	40	40	0.56	2.00	3.8	0.55	0.86	1.29	[0.205mm <sup>2</sup> (24)]
RXEF050	0.50	1.00	72	72	40	40	0.77	2.50	4.0	0.50	0.77	1.17	[0.205mm <sup>2</sup> (24)]
RXEF065	0.65	1.30	72	72	40	40	0.88	3.25	5.3	0.31	0.48	0.72	[0.205mm <sup>2</sup> (24)]
RXEF075	0.75	1.50	72	72	40	40	0.92	3.75	6.3	0.25	0.40	0.60	[0.205mm <sup>2</sup> (24)]
RXEF090	0.90	1.80	72	72	40	40	0.99	4.50	7.2	0.20	0.31	0.47	[0.205mm <sup>2</sup> (24)]
RXEF110	1.10	2.20	72	72	40	40	1.50	5.50	8.2	0.15	0.25	0.38	[0.520mm <sup>2</sup> (20)]
RXEF135	1.35	2.70	72	72	40	40	1.70	6.75	9.6	0.12	0.19	0.30	[0.520mm <sup>2</sup> (20)]
RXEF160	1.60	3.20	72	72	40	40	1.90	8.00	11.4	0.09	0.14	0.22	[0.520mm <sup>2</sup> (20)]
RXEF185	1.85	3.70	72	72	40	40	2.10	9.25	12.6	0.08	0.12	0.19	[0.520mm <sup>2</sup> (20)]
RXEF250	2.50	5.00	72	72	40	40	2.50	12.50	15.6	0.05	0.08	0.13	[0.520mm <sup>2</sup> (20)]
RXEF300	3.00	6.00	72	72	40	40	2.80	15.00	19.8	0.04	0.06	0.10	[0.520mm <sup>2</sup> (20)]
RXEF375	3.75	7.50	72	72	40	40	3.20	18.75	24.0	0.03	0.05	0.08	[0.520mm <sup>2</sup> (20)]

# PolySwitch Resettable Devices

## Radial-Leaded Devices

### Table R3 – Electrical Characteristics

(Cont'd)

Part Number	I <sub>H</sub> (A)	I <sub>T</sub> (A)	V <sub>MAX</sub>		I <sub>MAX</sub>		P <sub>D</sub> TYP (W)	Max Time-to-trip		R <sub>MIN</sub> (Ω)	R <sub>MAX</sub> (Ω)	R <sub>TMAX</sub> (Ω)	Lead Size [mm <sup>2</sup> (AWG)]
			(V <sub>DC</sub> )	(V <sub>AC RMS</sub> )	(DC <sub>ADC</sub> )	(AC <sub>ARMS</sub> )		(A)	(s)				
<b>RKEF; 60V</b>													
RKEF050	0.50	1.00	60	—	40	—	1.00	8.00	0.8	0.320	0.529	0.900	[0.205mm <sup>2</sup> (24)]
RKEF065	0.65	1.30	60	—	40	—	1.25	8.00	1.0	0.250	0.450	0.720	[0.205mm <sup>2</sup> (24)]
RKEF075	0.75	1.50	60	—	40	—	1.40	8.00	1.5	0.200	0.390	0.640	[0.205mm <sup>2</sup> (24)]
RKEF090	0.90	1.80	60	—	40	—	1.50	8.00	2.0	0.190	0.320	0.520	[0.205mm <sup>2</sup> (24)]
RKEF110	1.10	2.20	60	—	40	—	2.20	8.00	3.0	0.170	0.280	0.470	[0.520mm <sup>2</sup> (20)]
RKEF135	1.35	2.70	60	—	40	—	2.30	8.00	4.5	0.110	0.220	0.370	[0.520mm <sup>2</sup> (20)]
RKEF160	1.60	3.20	60	—	40	—	2.40	8.20	9.0	0.100	0.200	0.320	[0.520mm <sup>2</sup> (20)]
RKEF185	1.85	3.70	60	—	40	—	2.60	9.25	12.6	0.060	0.152	0.250	[0.520mm <sup>2</sup> (20)]
RKEF250	2.50	5.00	60	—	40	—	2.80	12.50	15.6	0.040	0.085	0.140	[0.520mm <sup>2</sup> (20)]
RKEF300	3.00	6.00	60	—	40	—	3.20	15.00	19.8	0.030	0.050	0.080	[0.520mm <sup>2</sup> (20)]
RKEF375	3.75	7.50	60	—	40	—	3.40	18.75	22.0	0.017	0.040	0.060	[0.520mm <sup>2</sup> (20)]
RKEF400	4.00	8.00	60	—	40	—	3.70	20.00	24.0	0.014	0.038	0.060	[0.520mm <sup>2</sup> (20)]
RKEF500	5.00	10.00	60	—	40	—	5.00	25.00	28.0	0.012	0.030	0.050	[0.520mm <sup>2</sup> (20)]
<b>RUEF; 30V</b>													
RUEF090	0.90	1.80	30	30	100	70	0.60	4.50	5.9	0.070	0.120	0.22	[0.205mm <sup>2</sup> (24)]
RUEF110	1.10	2.20	30	30	100	70	0.70	5.50	6.6	0.070	0.100	0.17	[0.205mm <sup>2</sup> (24)]
RUEF135	1.35	2.70	30	30	100	70	0.80	6.75	7.3	0.040	0.080	0.13	[0.205mm <sup>2</sup> (24)]
RUEF160	1.60	3.20	30	30	100	70	0.90	8.00	8.0	0.030	0.070	0.11	[0.205mm <sup>2</sup> (24)]
RUEF185	1.85	3.70	30	30	100	70	1.00	9.25	8.7	0.030	0.060	0.09	[0.205mm <sup>2</sup> (24)]
RUEF250	2.50	5.00	30	30	100	70	1.20	12.50	10.3	0.020	0.040	0.07	[0.205mm <sup>2</sup> (24)]
RUEF300	3.00	6.00	30	30	100	70	2.00	15.00	10.8	0.020	0.050	0.08	[0.520mm <sup>2</sup> (20)]
RUEF400	4.00	8.00	30	30	100	70	2.50	20.00	12.7	0.010	0.030	0.05	[0.520mm <sup>2</sup> (20)]
RUEF500	5.00	10.00	30	30	100	70	3.00	25.00	14.5	0.010	0.030	0.05	[0.520mm <sup>2</sup> (20)]
RUEF600	6.00	12.00	30	30	100	70	3.50	30.00	16.0	0.005	0.020	0.04	[0.520mm <sup>2</sup> (20)]
RUEF700	7.00	14.00	30	30	100	70	3.80	35.00	17.5	0.005	0.020	0.03	[0.520mm <sup>2</sup> (20)]
RUEF800	8.00	16.00	30	30	100	70	4.00	40.00	18.8	0.005	0.013	0.02	[0.520mm <sup>2</sup> (20)]
RUEF900	9.00	18.00	30	30	100	70	4.20	45.00	20.0	0.005	0.010	0.02	[0.520mm <sup>2</sup> (20)]
<b>RHEF*, 30V - High Temperature</b>													
RHEF050	0.5	0.9	30	—	40	—	0.9	2.5	2.5	0.480	0.780	1.10	[0.205mm <sup>2</sup> (24)]
RHEF070	0.7	1.4	30	—	40	—	1.4	3.5	3.2	0.300	0.540	0.80	[0.205mm <sup>2</sup> (24)]
RHEF100	1.0	1.8	30	—	40	—	1.4	5.0	5.2	0.180	0.300	0.43	[0.205mm <sup>2</sup> (24)]
<b>RUSBF; 16V</b>													
RUSBF090	0.90	1.8	16	—	40	—	0.6	8.0	1.2	0.070	0.120	0.180	[0.205mm <sup>2</sup> (24)]
RUSBF110	1.10	2.2	16	—	40	—	0.7	8.0	2.3	0.050	0.095	0.140	[0.205mm <sup>2</sup> (24)]
RUSBF135	1.35	2.7	16	—	40	—	0.8	8.0	4.5	0.040	0.074	0.112	[0.205mm <sup>2</sup> (24)]
RUSBF160	1.60	3.2	16	—	40	—	0.9	8.0	9.0	0.030	0.061	0.110	[0.205mm <sup>2</sup> (24)]
RUSBF185	1.85	3.7	16	—	40	—	1.0	8.0	10.0	0.030	0.051	0.090	[0.205mm <sup>2</sup> (24)]
RUSBF250	2.50	5.0	16	—	40	—	1.2	8.0	40.0	0.020	0.036	0.060	[0.205mm <sup>2</sup> (24)]
<b>RGEF*; 16V</b>													
RGEF250	2.5	4.7	16	—	100	—	1.0	12.5	5.0	0.0220	0.0350	0.0530	[0.205mm <sup>2</sup> (24)]
RGEF300	3.0	5.1	16	—	100	—	2.3	15.0	1.0	0.0380	0.0645	0.0975	[0.520mm <sup>2</sup> (20)]
RGEF400	4.0	6.8	16	—	100	—	2.4	20.0	1.7	0.0210	0.0390	0.0600	[0.520mm <sup>2</sup> (20)]
RGEF500	5.0	8.5	16	—	100	—	2.6	25.0	2.0	0.0150	0.0240	0.0340	[0.520mm <sup>2</sup> (20)]
RGEF600	6.0	10.2	16	—	100	—	2.8	30.0	3.3	0.0100	0.0190	0.0280	[0.520mm <sup>2</sup> (20)]
RGEF700	7.0	11.9	16	—	100	—	3.0	35.0	3.5	0.0077	0.0131	0.0200	[0.520mm <sup>2</sup> (20)]
RGEF800	8.0	13.6	16	—	100	—	3.0	40.0	5.0	0.0056	0.0110	0.0175	[0.520mm <sup>2</sup> (20)]
RGEF900	9.0	15.3	16	—	100	—	3.3	45.0	5.5	0.0047	0.0091	0.0135	[0.520mm <sup>2</sup> (20)]
RGEF1000	10.0	17.0	16	—	100	—	3.6	50.0	6.0	0.0040	0.0070	0.0102	[0.520mm <sup>2</sup> (20)]
RGEF1100	11.0	18.7	16	—	100	—	3.7	55.0	7.0	0.0037	0.0060	0.0089	[0.520mm <sup>2</sup> (20)]
RGEF1200	12.0	20.4	16	—	100	—	4.2	60.0	7.5	0.0033	0.0057	0.0086	[0.823mm <sup>2</sup> (18)]
RGEF1400	14.0	23.8	16	—	100	—	4.6	70.0	9.0	0.0026	0.0043	0.0064	[0.823mm <sup>2</sup> (18)]

# PolySwitch Resettable Devices

## Radial-Leaded Devices

### Table R3 – Electrical Characteristics

(Cont'd)

Part Number	$I_H$ (A)	$I_T$ (A)	$V_{MAX}$		$I_{MAX}$		$P_{D\text{Typ}}$ (W)	Max Time-to-trip		$R_{MIN}$ ( $\Omega$ )	$R_{MAX}$ ( $\Omega$ )	$R_{1MAX}$ ( $\Omega$ )	Lead Size [mm <sup>2</sup> (AWG)]
			( $V_{DC}$ )	( $V_{AC\text{RMS}}$ )	( $DC_{ADC}$ )	( $AC_{ARMS}$ )		(A)	(s)				
<b>RHEF*; 16V - High Temperature</b>													
RHEF200	2.0	3.8	16	—	100	—	1.4	10.0	4.3	0.0450	0.07400	0.1100	[0.205mm <sup>2</sup> (24)]
RHEF300	3.0	6.0	16	—	100	—	3.0	15.0	5.0	0.0330	0.05300	0.0790	[0.520mm <sup>2</sup> (20)]
RHEF400	4.0	7.5	16	—	100	—	3.3	20.0	5.0	0.0240	0.04000	0.0600	[0.520mm <sup>2</sup> (20)]
RHEF450	4.5	7.8	16	—	100	—	3.6	22.5	3.0	0.0220	0.03600	0.0540	[0.520mm <sup>2</sup> (20)]
RHEF550	5.5	10.0	16	—	100	—	3.5	27.5	6.0	0.0150	0.02500	0.0370	[0.520mm <sup>2</sup> (20)]
RHEF600	6.0	10.8	16	—	100	—	4.1	30.0	5.0	0.0130	0.02150	0.0320	[0.520mm <sup>2</sup> (20)]
RHEF650	6.5	12.0	16	—	100	—	4.1	32.5	5.5	0.0110	0.01750	0.0260	[0.520mm <sup>2</sup> (20)]
RHEF700	7.0	13.0	16	—	100	—	4.0	35.0	7.0	0.0100	0.01640	0.0250	[0.520mm <sup>2</sup> (20)]
RHEF750	7.5	13.1	16	—	100	—	4.5	37.5	7.0	0.0094	0.01530	0.0220	[0.520mm <sup>2</sup> (20)]
RHEF800	8.0	15.0	16	—	100	—	4.2	40.0	8.0	0.0080	0.01350	0.0200	[0.520mm <sup>2</sup> (20)]
RHEF900	9.0	16.5	16	—	100	—	5.0	45.0	10.0	0.0074	0.01200	0.0170	[0.520mm <sup>2</sup> (20)]
RHEF1000	10.0	18.5	16	—	100	—	5.3	50.0	9.0	0.0062	0.01050	0.0150	[0.520mm <sup>2</sup> (20)]
RHEF1100	11.0	20.0	16	—	100	—	5.5	55.0	11.0	0.0055	0.00900	0.0130	[0.520mm <sup>2</sup> (20)]
RHEF1300	13.0	24.0	16	—	100	—	6.9	65.0	13.0	0.0041	0.00690	0.0100	[0.823mm <sup>2</sup> (18)]
RHEF1400	14.0	27.0	16	—	100	—	6.9	70.0	13.0	0.0030	0.00600	0.0090	[0.823mm <sup>2</sup> (18)]
RHEF1500	15.0	28.0	16	—	100	—	7.0	75.0	20.0	0.0032	0.00613	0.0092	[0.823mm <sup>2</sup> (18)]
<b>RUSBF; 6V</b>													
RUSBF075	0.75	1.30	6	—	40	—	0.3	8.0	0.4	0.110	0.1750	0.23	[0.205mm <sup>2</sup> (24)]
RUSBF120	1.20	2.00	6	—	40	—	0.6	8.0	0.5	0.070	0.0975	0.14	[0.205mm <sup>2</sup> (24)]
RUSBF155	1.55	2.65	6	—	40	—	0.6	7.8	2.2	0.040	0.0705	0.10	[0.205mm <sup>2</sup> (24)]

**Notes:**

- $I_H$  : Hold current: maximum current device will pass without interruption in 20°C still air.
- $I_T$  : Trip current: minimum current that will switch the device from low resistance to high resistance in 20°C still air.
- $V_{MAX}$  : Maximum continuous voltage device can withstand without damage at rated current.
- $I_{MAX}$  : Maximum fault current device can withstand without damage at rated voltage.
- $P_D$  : Power dissipated from device when in the tripped state in 20°C still air.
- $R_{MIN}$  : Minimum resistance of device as supplied at 20°C unless otherwise specified.
- $R_{MAX}$  : Maximum resistance of device as supplied at 20°C unless otherwise specified.
- $R_{1MAX}$  : Maximum resistance of device when measured one hour post reflow (surface-mount device) or one hour post trip (radial-leaded device) at 20°C unless otherwise specified.
- \* Electrical characteristics determined at 25°C.

### Figures R6-R14 – Dimension Figures

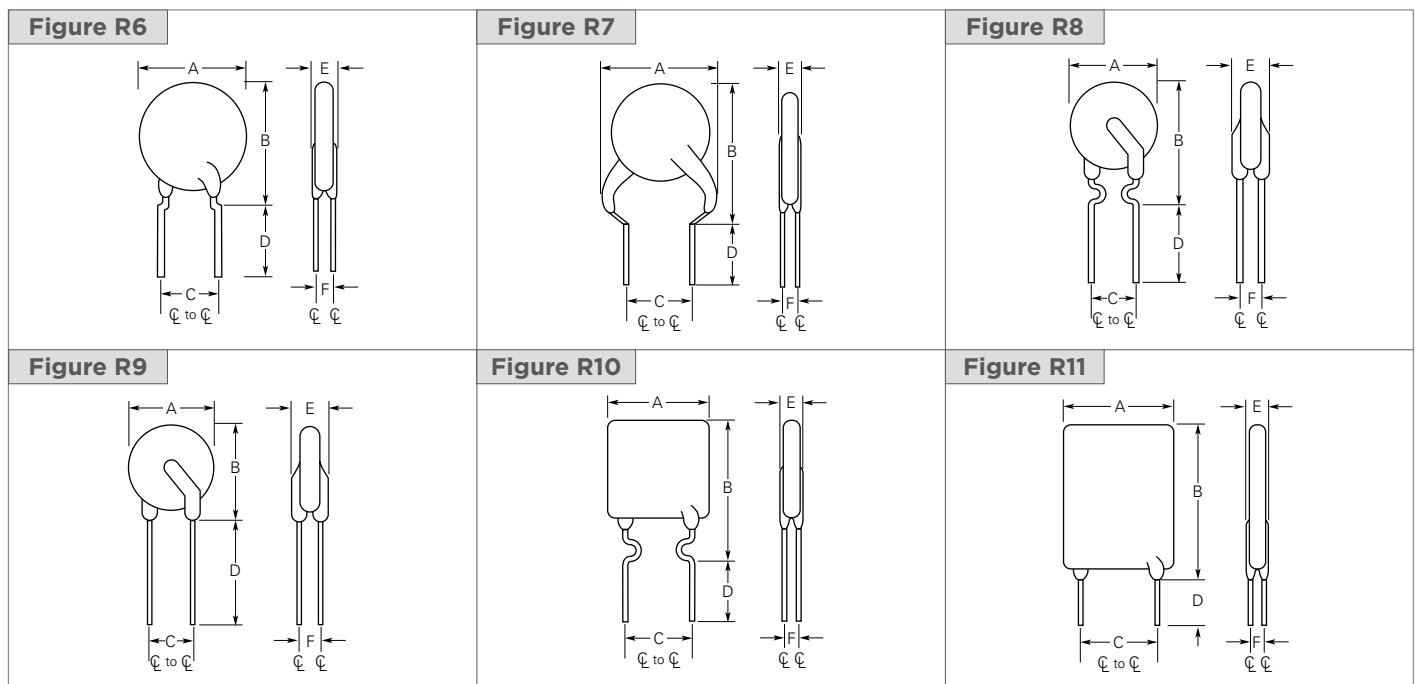

**PolySwitch Resettable Devices**  
**Radial-Leaded Devices**  
**Table R4 – Dimensions and Weights**

(Cont'd)

Part Number	Dimensions in Millimeters (Inches)													Figure	Device Mass (g) (Only for Reference)
	A		B		C		D		E		F	H	J		
	Min	Max	Min	Max	Min	Max	Min	Max	Min	Max	Typ	Typ	Typ		
<b>RKEF; 60V</b>															
RKEF050	—	7.10 (0.28)	—	11.43 (0.45)	4.32 (0.17)	5.84 (0.23)	7.60 (0.30)	—	—	3.56 (0.14)	—	—	—	R10, R13, R14	0.166
RKEF065	—	7.11 (0.28)	—	12.20 (0.48)	4.32 (0.17)	5.84 (0.23)	7.60 (0.30)	—	—	3.56 (0.14)	—	—	—	R10, R13, R14	0.182
RKEF075	—	7.87 (0.31)	—	12.20 (0.48)	4.32 (0.17)	5.84 (0.23)	7.60 (0.30)	—	—	3.56 (0.14)	—	—	—	R10, R13, R14	0.201
RKEF090	—	7.87 (0.31)	—	13.97 (0.55)	4.32 (0.17)	5.84 (0.23)	7.60 (0.30)	—	—	3.56 (0.14)	—	—	—	R10, R13, R14	0.235
RKEF110	—	7.60 (0.30)	—	15.00 (0.59)	4.32 (0.17)	5.84 (0.23)	7.60 (0.30)	—	—	4.10 (0.16)	—	—	—	R10, R13, R14	0.353
RKEF135	—	10.20 (0.40)	—	17.00 (0.67)	4.32 (0.17)	5.84 (0.23)	7.60 (0.30)	—	—	3.81 (0.15)	—	—	—	R11, R13, R14	0.438
RKEF160	—	12.20 (0.48)	—	18.30 (0.72)	4.32 (0.17)	5.84 (0.23)	7.60 (0.30)	—	—	3.81 (0.15)	—	—	—	R11, R13, R14	0.546
RKEF185	—	13.00 (0.51)	—	18.80 (0.74)	4.32 (0.17)	5.84 (0.23)	7.60 (0.30)	—	—	3.81 (0.15)	—	—	—	R11, R13, R14	0.538
RKEF250	—	14.00 (0.55)	—	20.60 (0.81)	4.32 (0.17)	5.84 (0.23)	7.60 (0.30)	—	—	3.00 (0.12)	—	—	—	R11, R13, R14	0.775
RKEF300	—	16.50 (0.65)	—	21.20 (0.83)	4.32 (0.17)	5.84 (0.23)	7.60 (0.30)	—	—	3.00 (0.12)	—	—	—	R11, R13, R14	0.971
RKEF375	—	16.50 (0.65)	—	25.20 (0.99)	9.40 (0.37)	10.90 (0.43)	7.60 (0.30)	—	—	3.00 (0.12)	—	—	—	R11, R13, R14	1.142
RKEF400	—	21.00 (0.83)	—	24.90 (0.98)	9.40 (0.37)	10.90 (0.43)	7.60 (0.30)	—	—	3.00 (0.12)	—	—	—	R11, R13, R14	1.391
RKEF500	—	24.10 (0.95)	—	29.00 (1.14)	9.40 (0.37)	10.90 (0.43)	7.60 (0.30)	—	—	3.00 (0.12)	—	—	—	R11, R13, R14	1.783
<b>RUEF; 30V</b>															
RUEF090	—	7.4 (0.29)	—	12.2 (0.48)	4.3 (0.17)	5.8 (0.23)	7.6 (0.30)	—	—	3.0 (0.12)	—	0.89 (0.035)	0.8 (0.03)	R10, R13, R14	0.183
RUEF110	—	7.4 (0.29)	—	14.2 (0.56)	4.3 (0.17)	5.8 (0.23)	7.6 (0.30)	—	—	3.0 (0.12)	—	0.89 (0.035)	0.8 (0.03)	R10, R13, R14	0.204
RUEF135	—	8.9 (0.35)	—	13.5 (0.53)	4.3 (0.17)	5.8 (0.23)	7.6 (0.30)	—	—	3.0 (0.12)	—	0.89 (0.035)	1.0 (0.04)	R10, R13, R14	0.255
RUEF160	—	8.9 (0.35)	—	15.2 (0.60)	4.3 (0.17)	5.8 (0.23)	7.6 (0.30)	—	—	3.0 (0.12)	—	0.89 (0.035)	1.0 (0.04)	R10, R13, R14	0.289
RUEF185	—	10.2 (0.40)	—	15.7 (0.62)	4.3 (0.17)	5.8 (0.23)	7.6 (0.30)	—	—	3.0 (0.12)	—	0.89 (0.035)	1.0 (0.04)	R10, R13, R14	0.379
RUEF250	—	11.4 (0.45)	—	18.3 (0.72)	4.3 (0.17)	5.8 (0.23)	7.6 (0.30)	—	—	3.0 (0.12)	—	0.89 (0.035)	1.2 (0.05)	R10, R13, R14	0.493
RUEF300	—	11.4 (0.45)	—	16.5 (0.65)	4.3 (0.17)	5.8 (0.23)	7.6 (0.30)	—	—	3.0 (0.12)	—	1.19 (0.047)	1.5 (0.06)	R11, R13, R14	0.516
RUEF400	—	14.0 (0.55)	—	19.3 (0.76)	4.3 (0.17)	5.8 (0.23)	7.6 (0.30)	—	—	3.0 (0.12)	—	1.19 (0.047)	1.7 (0.07)	R11, R13, R14	0.670
RUEF500	—	14.0 (0.55)	—	24.1 (0.95)	9.4 (0.37)	10.9 (0.43)	7.6 (0.30)	—	—	3.0 (0.12)	—	1.19 (0.047)	1.0 (0.04)	R11, R13, R14	0.926
RUEF600	—	16.5 (0.65)	—	24.1 (0.95)	9.4 (0.37)	10.9 (0.43)	7.6 (0.30)	—	—	3.0 (0.12)	—	1.19 (0.047)	1.0 (0.04)	R11, R13, R14	1.352
RUEF700	—	19.1 (0.75)	—	25.9 (1.02)	9.4 (0.37)	10.9 (0.43)	7.6 (0.30)	—	—	3.0 (0.12)	—	1.19 (0.047)	1.2 (0.05)	R11, R13, R14	1.543
RUEF800	—	21.6 (0.85)	—	28.4 (1.12)	9.4 (0.37)	10.9 (0.43)	7.6 (0.30)	—	—	3.0 (0.12)	—	1.19 (0.047)	1.5 (0.06)	R11, R13, R14	1.852
RUEF900	—	24.1 (0.95)	—	29.0 (1.14)	9.4 (0.37)	10.9 (0.43)	7.6 (0.30)	—	—	3.0 (0.12)	—	1.19 (0.047)	1.5 (0.06)	R11, R13, R14	2.104

# PolySwitch Resettable Devices

## Radial-Leaded Devices

### Figures R6-R14 – Dimension Figures

(Cont'd)

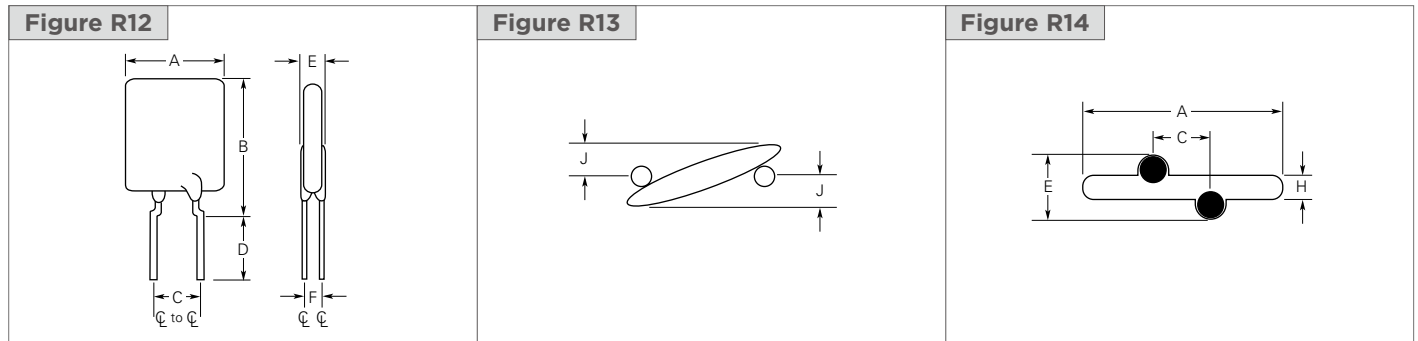

### Table R4 – Dimensions and Weights

Part Number	Dimensions in Millimeters (Inches)														Figure	Device Mass (g) (Only for Reference)
	A		B		C		D		E		F	H	J			
	Min	Max	Min	Max	Min	Max	Min	Max	Min	Max	Typ	Typ	Typ			
<b>RXEF; 60V</b>																
RXEF005	—	8.0 (0.32)	—	8.3 (0.33)	4.3 (0.17)	5.8 (0.23)	7.6 (0.30)	—	—	3.0 (0.12)	—	1.07 (0.042)	1.0 (0.04)	R7, R13, R14	0.069	
RXEF010	—	7.4 (0.29)	—	11.6 (0.46)	4.3 (0.17)	5.8 (0.23)	7.6 (0.30)	—	—	3.0 (0.12)	—	1.07 (0.042)	1.0 (0.04)	R8, R13, R14	0.128	
RXEF017	—	7.4 (0.29)	—	12.7 (0.50)	4.3 (0.17)	5.8 (0.23)	7.6 (0.30)	—	—	3.0 (0.12)	—	1.68 (0.066)	1.7 (0.07)	R8, R13, R14	0.174	
<b>RXEF; 72V</b>																
RXEF020	—	7.4 (0.29)	—	11.7 (0.46)	4.3 (0.17)	5.8 (0.23)	7.6 (0.30)	—	—	3.0 (0.12)	—	1.17 (0.046)	1.0 (0.04)	R8, R13, R14	0.119	
RXEF025	—	7.4 (0.29)	—	12.7 (0.50)	4.3 (0.17)	5.8 (0.23)	7.6 (0.30)	—	—	3.0 (0.12)	—	1.17 (0.046)	1.0 (0.04)	R8, R13, R14	0.130	
RXEF030	—	7.4 (0.29)	—	12.7 (0.50)	4.3 (0.17)	5.8 (0.23)	7.6 (0.30)	—	—	3.0 (0.12)	—	1.17 (0.046)	1.0 (0.04)	R8, R13, R14	0.143	
RXEF040	—	7.6 (0.30)	—	13.5 (0.53)	4.3 (0.17)	5.8 (0.23)	7.6 (0.30)	—	—	3.0 (0.12)	—	1.17 (0.046)	1.2 (0.05)	R8, R13, R14	0.202	
RXEF050	—	7.9 (0.31)	—	13.7 (0.54)	4.3 (0.17)	5.8 (0.23)	7.6 (0.30)	—	—	3.0 (0.12)	—	1.17 (0.046)	1.2 (0.05)	R8, R13, R14	0.210	
RXEF065	—	9.4 (0.37)	—	14.5 (0.57)	4.3 (0.17)	5.8 (0.23)	7.6 (0.30)	—	—	3.0 (0.12)	—	1.17 (0.046)	1.5 (0.06)	R8, R13, R14	0.277	
RXEF075	—	10.2 (0.40)	—	15.2 (0.60)	4.3 (0.17)	5.8 (0.23)	7.6 (0.30)	—	—	3.0 (0.12)	—	1.17 (0.046)	1.5 (0.06)	R8, R13, R14	0.310	
RXEF090	—	11.2 (0.44)	—	15.8 (0.62)	4.3 (0.17)	5.8 (0.23)	7.6 (0.30)	—	—	3.0 (0.12)	—	1.17 (0.046)	1.5 (0.06)	R8, R13, R14	0.365	
RXEF110	—	12.8 (0.50)	—	17.5 (0.69)	4.3 (0.17)	5.8 (0.23)	7.6 (0.30)	—	—	3.0 (0.12)	—	1.37 (0.054)	1.2 (0.05)	R9, R13, R14	0.546	
RXEF135	—	14.5 (0.57)	—	19.1 (0.75)	4.3 (0.17)	5.8 (0.23)	7.6 (0.30)	—	—	3.0 (0.12)	—	1.37 (0.054)	1.2 (0.05)	R9, R13, R14	0.653	
RXEF160	—	16.3 (0.64)	—	20.8 (0.82)	4.3 (0.17)	5.8 (0.23)	7.6 (0.30)	—	—	3.0 (0.12)	—	1.37 (0.054)	1.5 (0.06)	R9, R13, R14	0.684	
RXEF185	—	17.5 (0.69)	—	22.4 (0.88)	4.3 (0.17)	5.8 (0.23)	7.6 (0.30)	—	—	3.0 (0.12)	—	1.37 (0.054)	1.5 (0.06)	R9, R13, R14	0.808	
RXEF250	—	20.8 (0.82)	—	25.4 (1.00)	9.4 (0.37)	10.9 (0.43)	7.6 (0.30)	—	—	3.0 (0.12)	—	1.37 (0.054)	1.7 (0.07)	R9, R13, R14	1.139	
RXEF300	—	23.9 (0.94)	—	28.6 (1.13)	9.4 (0.37)	10.9 (0.43)	7.6 (0.30)	—	—	3.0 (0.12)	—	1.37 (0.054)	1.7 (0.07)	R9, R13, R14	1.379	
RXEF375	—	27.2 (1.07)	—	31.8 (1.25)	9.4 (0.37)	10.9 (0.43)	7.6 (0.30)	—	—	3.0 (0.12)	—	1.37 (0.054)	1.7 (0.07)	R9, R13, R14	1.708	

# PolySwitch Resettable Devices

## Radial-Leaded Devices

Table R4 — Dimensions and Weights

(Cont'd)

Part Number	Dimensions in Millimeters (Inches)														Figure	Device Mass (g) (Only for Reference)
	A		B		C		D		E		F	H	J			
	Min	Max	Min	Max	Min	Max	Min	Max	Min	Max	Typ	Typ	Typ			
<b>RHEF; 16V - High Temperature</b>																
RHEF450	—	10.4 (0.41)	—	15.6 (0.61)	4.3 (0.17)	5.8 (0.23)	7.6 (0.30)	—	—	3.0 (0.12)	1.2 (0.05)	1.24 (0.049)	1.6 (0.06)	R12, R13, R14	0.605	
RHEF550	—	11.2 (0.44)	—	18.9 (0.74)	4.3 (0.17)	5.8 (0.23)	7.6 (0.30)	—	—	3.0 (0.12)	1.2 (0.05)	—	—	R12, R13, R14	0.704	
RHEF600	—	11.2 (0.44)	—	21.0 (0.83)	4.3 (0.17)	5.8 (0.23)	7.6 (0.30)	—	—	3.0 (0.12)	1.2 (0.05)	1.24 (0.049)	1.7 (0.067)	R12, R13, R14	0.792	
RHEF650	—	12.7 (0.50)	—	22.2 (0.88)	4.3 (0.17)	5.8 (0.23)	7.6 (0.30)	—	—	3.0 (0.12)	1.2 (0.05)	1.24 (0.049)	1.8 (0.07)	R12, R13, R14	0.952	
RHEF700	—	14.0 (0.55)	—	21.9 (0.86)	4.3 (0.17)	5.8 (0.23)	7.6 (0.30)	—	—	3.0 (0.12)	1.2 (0.05)	—	—	R12, R13, R14	0.850	
RHEF750	—	14.0 (0.55)	—	23.5 (0.93)	4.3 (0.17)	5.8 (0.23)	7.6 (0.30)	—	—	3.0 (0.12)	1.2 (0.05)	1.24 (0.049)	2.0 (0.08)	R12, R13, R14	1.054	
RHEF800	—	16.5 (0.65)	—	22.5 (0.88)	4.3 (0.17)	5.8 (0.23)	7.6 (0.30)	—	—	3.0 (0.12)	1.2 (0.05)	—	—	R12, R13, R14	1.073	
RHEF900	—	16.5 (0.65)	—	25.7 (1.01)	4.3 (0.17)	5.8 (0.23)	7.6 (0.30)	—	—	3.0 (0.12)	1.2 (0.05)	—	—	R12, R13, R14	1.516	
RHEF1000	—	17.5 (0.69)	—	26.5 (1.04)	9.4 (0.37)	10.9 (0.43)	7.6 (0.30)	—	—	3.0 (0.12)	1.2 (0.05)	1.24 (0.049)	1.5 (0.06)	R12, R13, R14	1.791	
RHEF1100	—	21.0 (0.83)	—	26.1 (1.03)	9.4 (0.37)	10.9 (0.43)	7.6 (0.30)	—	—	3.0 (0.12)	1.2 (0.05)	—	—	R12, R13, R14	1.570	
RHEF1300	—	23.5 (0.925)	—	28.7 (1.13)	9.4 (0.37)	10.9 (0.43)	7.6 (0.30)	—	—	3.6 (0.14)	1.4 (0.06)	1.45 (0.057)	1.9 (0.084)	R12, R13, R14	2.257	
RHEF1400	—	23.5 (0.925)	—	28.6 (1.13)	9.4 (0.37)	10.9 (0.43)	7.6 (0.30)	—	—	3.6 (0.14)	1.4 (0.06)	—	—	R12, R13, R14	2.051	
RHEF1500	—	23.5 (0.925)	—	28.7 (1.13)	9.4 (0.37)	10.9 (0.43)	7.6 (0.30)	—	—	3.6 (0.14)	1.4 (0.06)	1.45 (0.057)	1.9 (0.084)	R12, R13, R14	2.257	
<b>RUSBF; 6V</b>																
RUSBF075	—	6.9 (0.27)	—	11.4 (0.45)	4.3 (0.17)	5.9 (0.23)	7.6 (0.30)	—	—	3.1 (0.12)	—	0.91 (0.036)	1.0 (0.04)	R8, R13, R14	0.123	
RUSBF120	—	6.9 (0.27)	—	11.7 (0.46)	4.3 (0.17)	5.9 (0.23)	7.6 (0.30)	—	—	3.1 (0.12)	—	0.91 (0.036)	1.0 (0.04)	R8, R13, R14	0.111	
RUSBF155	—	6.9 (0.27)	—	11.7 (0.46)	4.3 (0.17)	5.9 (0.23)	7.6 (0.30)	—	—	3.1 (0.12)	—	0.91 (0.036)	1.0 (0.04)	R8, R13, R14	0.135	

# PolySwitch Resettable Devices

## Radial-Leaded Devices

### Table R4 — Dimensions and Weights

(Cont'd)

Part Number	Dimensions in Millimeters (Inches)														Figure	Device Mass (g) (Only for Reference)
	A		B		C		D		E		F	H	J			
	Min	Max	Min	Max	Min	Max	Min	Max	Min	Max	Typ	Typ	Typ			
<b>RHEF; 30V - High Temperature</b>																
RHEF050	—	7.4 (0.29)	—	12.7 (0.50)	4.3 (0.17)	5.8 (0.23)	7.6 (0.30)	—	—	3.0 (0.12)	1.2 (0.05)	—	—	R8, R13, R14	0.177	
RHEF070	—	6.9 (0.27)	—	10.8 (0.43)	4.3 (0.17)	5.8 (0.23)	7.6 (0.30)	—	—	3.0 (0.12)	1.2 (0.05)	1.24 (0.049)	1.2 (0.05)	R10, R13, R14	0.259	
RHEF100	—	9.7 (0.38)	—	13.6 (0.54)	4.3 (0.17)	5.8 (0.23)	7.6 (0.30)	—	—	3.0 (0.12)	—	—	—	R8, R13, R14	0.312	
<b>RUSBF; 16V</b>																
RUSBF090	—	7.4 (0.29)	—	12.2 (0.48)	4.3 (0.17)	5.8 (0.23)	7.6 (0.30)	—	—	3.1 (0.12)	—	0.89 (0.035)	0.8 (0.03)	R10, R13, R14	0.183	
RUSBF110	—	7.4 (0.29)	—	14.2 (0.56)	4.3 (0.17)	5.8 (0.23)	7.6 (0.30)	—	—	3.0 (0.12)	—	0.89 (0.035)	0.8 (0.03)	R10, R13, R14	0.204	
RUSBF135	—	8.9 (0.35)	—	13.5 (0.53)	4.3 (0.17)	5.8 (0.23)	7.6 (0.30)	—	—	3.0 (0.12)	—	0.89 (0.035)	1.0 (0.04)	R10, R13, R14	0.240	
RUSBF160	—	8.9 (0.35)	—	15.2 (0.60)	4.3 (0.17)	5.8 (0.23)	7.6 (0.30)	—	—	3.0 (0.12)	—	0.89 (0.035)	1.0 (0.04)	R10, R13, R14	0.300	
RUSBF185	—	10.2 (0.40)	—	15.7 (0.62)	4.3 (0.17)	5.8 (0.23)	7.6 (0.30)	—	—	3.0 (0.12)	—	0.89 (0.035)	1.0 (0.04)	R10, R13, R14	0.368	
RUSBF250	—	11.4 (0.45)	—	18.3 (0.72)	4.3 (0.17)	5.8 (0.23)	7.6 (0.30)	—	—	3.0 (0.12)	—	0.89 (0.035)	1.2 (0.05)	R10, R13, R14	0.467	
<b>RGEF; 16V</b>																
RGEF250	—	8.9 (0.35)	—	12.8 (0.50)	4.3 (0.17)	5.8 (0.23)	3.18 (0.13)	6.18 (0.24)	—	3.0 (0.12)	1.2 (0.05)	1.24 (0.049)	1.2 (0.05)	R10, R13, R14	0.277	
RGEF300	6.1 (0.24)	7.1 (0.28)	6.1 (0.24)	11.0 (0.43)	4.3 (0.17)	5.8 (0.23)	7.6 (0.30)	—	2.0 (0.08)	3.0 (0.12)	1.2 (0.05)	1.24 (0.049)	1.2 (0.05)	R11, R13, R14	0.323	
RGEF400	7.9 (0.31)	8.9 (0.35)	7.9 (0.31)	12.8 (0.50)	4.3 (0.17)	5.8 (0.23)	7.6 (0.30)	—	2.0 (0.08)	3.0 (0.12)	1.2 (0.05)	1.24 (0.049)	1.4 (0.06)	R11, R13, R14	0.417	
RGEF500	9.4 (0.37)	10.4 (0.41)	9.4 (0.37)	14.3 (0.56)	4.3 (0.17)	5.8 (0.23)	7.6 (0.30)	—	2.0 (0.08)	3.0 (0.12)	1.2 (0.05)	1.24 (0.049)	1.6 (0.06)	R11, R13, R14	0.540	
RGEF600	9.7 (0.38)	10.7 (0.42)	12.2 (0.48)	17.1 (0.67)	4.3 (0.17)	5.8 (0.23)	7.6 (0.30)	—	2.0 (0.08)	3.0 (0.12)	1.2 (0.05)	1.24 (0.049)	1.6 (0.06)	R11, R13, R14	0.604	
RGEF700	10.2 (0.40)	11.2 (0.44)	14.7 (0.58)	19.7 (0.78)	4.3 (0.17)	5.8 (0.23)	7.6 (0.30)	—	2.0 (0.08)	3.0 (0.12)	1.2 (0.05)	1.24 (0.049)	1.7 (0.07)	R11, R13, R14	0.701	
RGEF800	11.7 (0.46)	12.7 (0.50)	16.0 (0.63)	20.9 (0.82)	4.3 (0.17)	5.8 (0.23)	7.6 (0.30)	—	2.0 (0.08)	3.0 (0.12)	1.2 (0.05)	1.24 (0.049)	1.8 (0.07)	R11, R13, R14	0.829	
RGEF900	13.0 (0.51)	14.0 (0.55)	16.8 (0.66)	21.7 (0.85)	4.3 (0.17)	5.8 (0.23)	7.6 (0.30)	—	2.0 (0.08)	3.0 (0.12)	1.2 (0.05)	1.24 (0.049)	2.0 (0.08)	R11, R13, R14	0.887	
RGEF1000	—	16.5 (0.65)	21.1 (0.83)	25.2 (0.99)	4.3 (0.17)	5.8 (0.23)	7.6 (0.30)	—	2.0 (0.08)	3.0 (0.12)	1.2 (0.05)	1.24 (0.049)	2.0 (0.08)	R11, R13, R14	1.219	
RGEF1100	16.5 (0.65)	17.5 (0.69)	21.1 (0.83)	26.0 (1.02)	4.3 (0.17)	5.8 (0.23)	7.6 (0.30)	—	2.0 (0.08)	3.0 (0.12)	1.2 (0.05)	1.24 (0.049)	2.4 (0.09)	R11, R13, R14	1.408	
RGEF1200	16.4 (0.65)	17.5 (0.69)	22.6 (0.89)	28.0 (1.10)	9.4 (0.37)	10.9 (0.43)	7.6 (0.30)	—	2.3 (0.09)	3.5 (0.14)	1.4 (0.06)	1.45 (0.057)	1.5 (0.06)	R11, R13, R14	1.650	
RGEF1400	—	23.5 (0.925)	22.6 (0.89)	27.9 (1.10)	9.4 (0.37)	10.9 (0.43)	7.6 (0.30)	—	2.3 (0.09)	3.5 (0.14)	1.4 (0.06)	1.45 (0.057)	1.9 (0.08)	R11, R13, R14	2.146	
<b>RHEF; 16V - High Temperature</b>																
RHEF200	—	9.4 (0.37)	—	14.4 (0.57)	4.3 (0.17)	5.8 (0.23)	7.6 (0.30)	—	—	3.1 (0.12)	—	—	—	R8, R13, R14	0.278	
RHEF300	—	8.8 (0.35)	—	13.8 (0.55)	4.3 (0.17)	5.8 (0.23)	7.6 (0.30)	—	—	3.0 (0.12)	1.2 (0.05)	—	—	R12, R13, R14	0.433	
RHEF400	—	10.0 (0.39)	—	15.0 (0.59)	4.3 (0.17)	5.8 (0.23)	7.6 (0.30)	—	—	3.0 (0.12)	1.2 (0.05)	1.24 (0.049)	1.6 (0.06)	R12, R13, R14	0.509	

# PolySwitch Resettable Devices

## Radial-Leaded Devices

### Figures R15-R20 – Typical Time-to-Trip Curves at 20°C

#### RXEF

A = RXEF005	J = RXEF075
B = RXEF010	K = RXEF090
C = RXEF017	L = RXEF110
D = RXEF020	M = RXEF135
E = RXEF025	N = RXEF160
F = RXEF030	O = RXEF185
G = RXEF040	P = RXEF250
H = RXEF050	Q = RXEF300
I = RXEF065	R = RXEF375

**Figure R15**

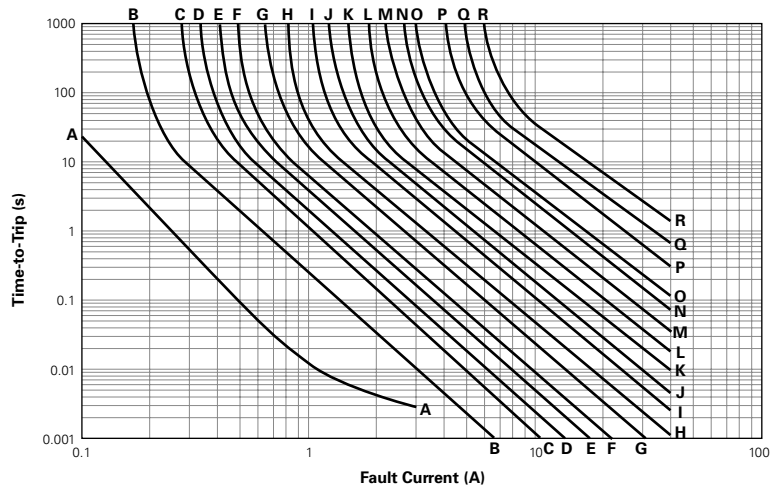

#### RKEF

A = RKEF050	J = RKEF300
B = RKEF065	K = RKEF375
C = RKEF075	L = RKEF400
D = RKEF090	M = RKEF500
E = RKEF110	
F = RKEF135	
G = RKEF160	
H = RKEF185	
I = RKEF250	

**Figure R16**

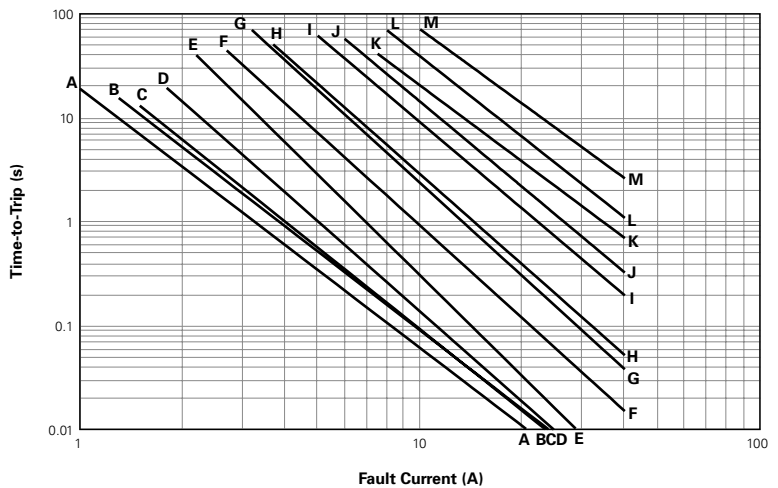

#### RUEF

A = RUEF090	H = RUEF400
B = RUEF110	I = RUEF500
C = RUEF135	J = RUEF600
D = RUEF160	K = RUEF700
E = RUEF185	L = RUEF800
F = RUEF250	M = RUEF900
G = RUEF300	

**Figure R17**



# PolySwitch Resettable Devices

## Radial-Leaded Devices

Figures R15-R20 – Typical Time-to-Trip Curves at 20°C

(Cont'd)

### RGEF (data at 25°C)

A = RGEF250	G = RGEF800
B = RGEF300	H = RGEF900
C = RGEF400	I = RGEF1000
D = RGEF500	J = RGEF1100
E = RGEF600	K = RGEF1200
F = RGEF700	L = RGEF1400

Figure R18

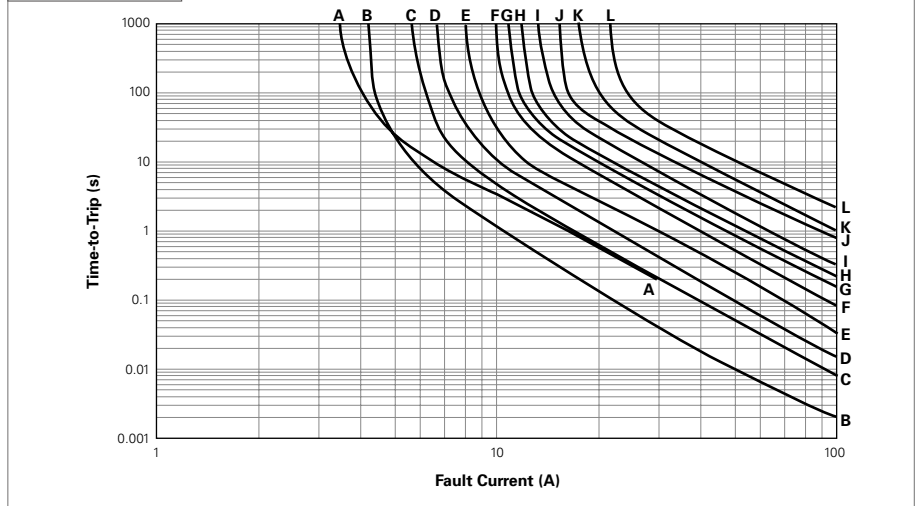

### RHEF (data at 25°C)

A = RHEF050	K = RHEF700
B = RHEF070	L = RHEF750
C = RHEF100	M = RHEF800
D = RHEF200	N = RHEF900
E = RHEF300	O = RHEF1000
F = RHEF400	P = RHEF1100
G = RHEF450	Q = RHEF1300
H = RHEF550	R = RHEF1400
I = RHEF600	S = RHEF1500
J = RHEF650	

Figure R19

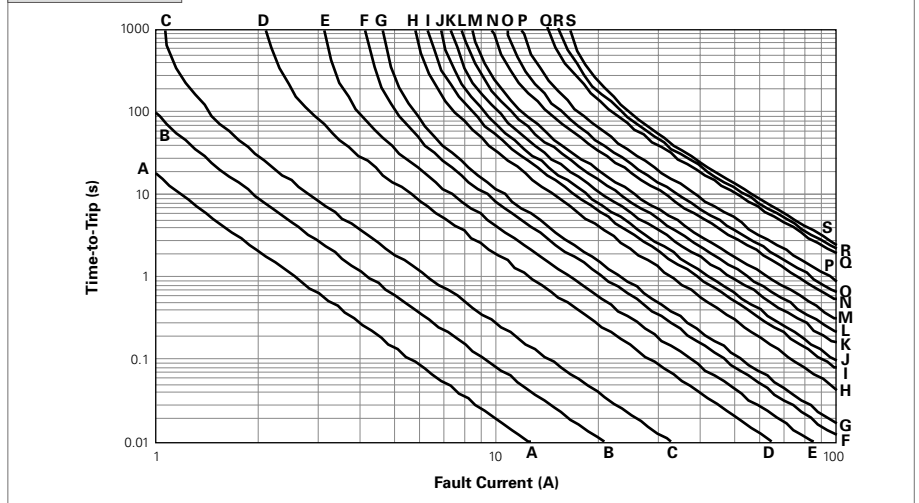

### RUSBF

A = RUSBF075
B = RUSBF090
C = RUSBF110
D = RUSBF120
E = RUSBF135
F = RUSBF155
G = RUSBF160
H = RUSBF185
I = RUSBF250

Figure R20

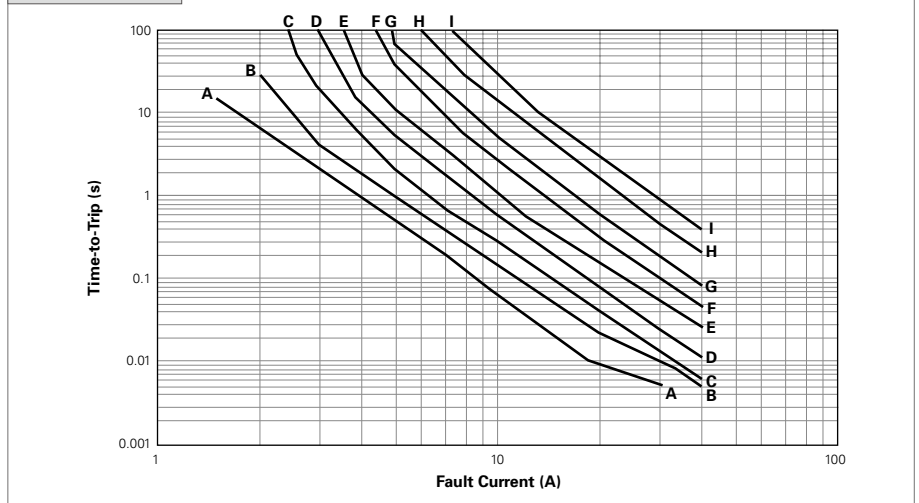

# PolySwitch Resettable Devices

## Radial-Leaded Devices

### Table R5 — Physical Characteristics and Environmental Specifications

RXEF		
Physical Characteristics		
Lead Material	RXEF005	: Tin-plated Nickel-copper Alloy, 0.128mm <sup>2</sup> (26AWG), ø0.40mm (0.016in)
	RXEF010	: Tin-plated Nickel-copper Alloy, 0.205mm <sup>2</sup> (24AWG), ø0.51mm (0.020in)
	RXEF017 to 040	: Tin-plated Copper-clad Steel, 0.205mm <sup>2</sup> (24AWG), ø0.51mm (0.020in)
	RXEF050 to 090	: Tin-plated Copper, 0.205mm <sup>2</sup> (24AWG), ø0.51mm (0.020in)
	RXEF110 to 375	: Tin-plated Copper, 0.52mm <sup>2</sup> (20AWG), ø0.81mm (0.032in)
Soldering Characteristics	Solderability per ANSI/J-STD-002 Category 3	
	RXEF005, RXEF010 Meet ANSI/J-STD-002 Category 1	
Solder Heat Withstand	RXEF005- RXEF025: per IEC-STD 68-2-20, Test Tb, Method 1a, Condition a; Can Withstand 5s at 260°C ±5°C	
	All Other Sizes : per IEC-STD 68-2-20, Test Tb, Method 1a, Condition b; Can Withstand 10s at 260°C ±5°C	
Insulating Material	Cured, Flame-retardant Epoxy Polymer; Meets UL 94V-0	
Operation Temperature	-40°C~85°C	

**Note:** Devices are not designed to be placed through a reflow process.

Environmental Specifications		
Test	Conditions	Resistance Change
Passive Aging	-40°C, 1000 hrs	±5%
	85°C, 1000 hrs	±5%
Humidity Aging	85°C, 85%RH, 1000 hrs	±10%
Thermal Shock	85°C, -40°C (10 Times)	±10%
Solvent Resistance	MIL-STD-202, Method 215F	No Change

RKEF		
Physical Characteristics		
Lead Material	RKEF050 to 090	: Tin-plated Copper, 0.205mm <sup>2</sup> (24AWG), ø0.51mm (0.020in)
	RKEF110 to 500	: Tin-plated Copper, 0.52mm <sup>2</sup> (20AWG), ø0.81mm (0.032in)
Soldering Characteristics	Solderability per ANSI/J-STD-002 Category 3	
Solder Heat Withstand	RKEF050-RKEF185: per IEC-STD 68-2-20, Test Tb, Method 1a, Condition a; Can Withstand 5s at 260°C ±5°C	
	All Other Sizes : per IEC-STD 68-2-20, Test Tb, Method 1a, Condition b; RKEF Can Withstand 10s at 260°C ±5°C	
Insulating Material	Cured, Flame-retardant Epoxy Polymer; Meets UL 94V-0	
Operation Temperature	-40°C~85°C	

**Note:** Devices are not designed to be placed through a reflow process.

Environmental Specifications		
Test	Conditions	Resistance Change
Passive Aging	-40°C, 1000 hrs	±5%
	85°C, 1000 hrs	±5%
Humidity Aging	85°C, 85%RH, 1000 hrs	±10%
Thermal Shock	85°C, -40°C (10 Times)	±10%
Solvent Resistance	MIL-STD-202, Method 215F	No Change

## PolySwitch Resettable Devices

### Radial-Leaded Devices

Table R5 — Physical Characteristics and Environmental Specifications

(Cont'd)

RUEF	
Physical Characteristics	
Lead Material	RUEF090 to RUEF250: Tin-plated Copper-clad Steel, 0.205mm <sup>2</sup> (24AWG) RUEF300 to RUEF900: Tin-plated Copper, 0.52mm <sup>2</sup> (20AWG), ø0.81mm (0.032in)
Soldering Characteristics	Solderability per ANSI/J-STD-002 Category 3
Solder Heat Withstand	per IEC-STD 68-2-20, Test Tb, Method1A, Condition B, Can Withstand 10s at 260°C ±5°C
Insulating Material	Cured, Flame-retardant Epoxy Polymer; Meets UL 94V-0
Operation Temperature	-40°C~85°C

**Note:** Devices are not designed to be placed through a reflow process.

Environmental Specifications		
Test	Conditions	Resistance Change
Passive Aging	70°C, 1000 hrs	±5%
	85°C, 1000 hrs	±5%
Humidity Aging	85°C, 85%RH, 1000 hrs	±5%
Thermal Shock	85°C, -40°C (10 times)	±5%
Solvent Resistance	MIL-STD-202, Method 215F	No Change

RUSBF	
Physical Characteristics	
Lead Material	RUSBF075 : Tin-plated Nickel-copper Alloy, 0.205mm <sup>2</sup> (24AWG), ø0.51mm/0.020in RUSBF090 to RUSBF250: Tin-plated Copper-clad Steel, 0.205mm <sup>2</sup> (24AWG), ø0.51mm/0.020in
Soldering Characteristics	Solderability per ANSI/J-STD-002 Category 3 Except RUSBF075 Meet ANSI/J-STD-002 Category 1
Solder Heat Withstand	RUSBF120: per IEC-STD 68-2-20, Test Tb, Method 1A, Condition A; Can Withstand 5s at 260°C ±5°C All Others : per IEC-STD 68-2-20, Test Tb, Method 1A, Condition B; Can Withstand 10s at 260°C ±5°C
Insulating Material	Cured, Flame-retardant Epoxy Polymer; Meets UL 94V-0
Operation Temperature	-40°C~85°C

**Note:** Devices are not designed to be placed through a reflow process.

Environmental Specifications		
Test	Conditions	Resistance Change
Passive Aging	70°C, 1000 hrs	±5%
	85°C, 1000 hrs	±5%
Humidity Aging	85°C, 85%RH, 1000 hrs	±5%
Thermal Shock	85°C, -40°C (10 Times)	±5%
Solvent Resistance	MIL-STD-202, Method 215F	No change

# PolySwitch Resettable Devices

## Radial-Leaded Devices

Table R5 — Physical Characteristics and Environmental Specifications

(Cont'd)

RGEF	
Physical Characteristics	
Lead Material	RGEF250 : Tin-plated Copper-clad Steel, 0.205mm <sup>2</sup> (24AWG), ø0.51mm/0.020in RGEF300 to RGEF1100 : Tin-plated Copper, 0.52mm <sup>2</sup> (20AWG), ø0.81mm/0.032in RGEF1200 to RGEF1400: Tin-plated Copper, 0.82mm <sup>2</sup> (18AWG), ø1.0mm/0.04in
Soldering Characteristics	Solderability per ANSI/J-STD-002 Category 3
Solder Heat Withstand	RGEF250 and RGEF400 : per IEC 68-2-20, Test Tb, Method 1a, Condition a; can withstand 5s at 260°C ±5°C RGEF500 to RGEF1400 : per IEC 68-2-20, Test Tb, Method 1a, Condition b; can withstand 10s at 260°C ±5°C
Insulating Material	Cured, Flame-retardant Epoxy Polymer; Meets UL 94V-0
Operation Temperature	-40°C~85°C

**Note:** Devices are not designed to be placed through a reflow process.

Environmental Specifications		
Test	Conditions	Resistance Change
Passive Aging	-40°C, 1000 hrs	±5%
	85°C, 1000 hrs	±5%
Humidity Aging	85°C, 85%RH, 1000 hrs	±5%
Thermal Shock	85°C, -40°C (10 Times)	±5%
Solvent Resistance	MIL-STD-202, Method 215F	No Change

RHEF	
Physical Characteristics	
Lead Material	RHEF050 to RHEF200 : Tin-plated Copper-clad Steel, 0.205mm <sup>2</sup> (24AWG), ø0.51mm/0.020in RHEF300 to RHEF1100 : Tin-plated Copper, 0.52mm <sup>2</sup> (20AWG), ø0.81mm/0.032in RHEF1300 to RHEF1500: Tin-plated Copper, 0.82mm <sup>2</sup> (18AWG), ø1.0mm/0.04in
Soldering Characteristics	Solderability per ANSI/J-STD-002 Category 3
Solder Heat Withstand	per IEC 68-2-20, Test Tb, Method 1A, Condition B; Can Withstand 10s at 260°C ±5°C
Insulating Material	Cured, Flame-retardant Epoxy Polymer; Meets UL 94V-0
Operation Temperature	-40°C~125°C

**Note:** Devices are not designed to be placed through a reflow process.

Environmental Specifications		
Test	Conditions	Resistance Change
Passive Aging	70°C, 1000 hrs	±5%
	85°C, 1000 hrs	±5%
Humidity Aging	85°C, 85%RH, 1000 hrs	±5%
Thermal Shock	125°C, -40°C (10 Times)	±5%
Solvent Resistance	MIL-STD-202, Method 215F	No Change

## Storage Conditions

Storage Conditions 40°C max, 70% RH max; devices should remain in original sealed bags prior to use.  
Devices may not meet specified values if these storage conditions are exceeded.

# PolySwitch Resettable Devices

## Radial-Leaded Devices

### Table R6 – Packaging and Marking Information

Part Number	Bag Quantity	Tape and Reel Quantity	Ammo Pack Quantity	Standard Package Quantity	Part Marking	Agency Recognition
<b>RXEF 60V</b>						
RXEF005	500	—	—	10,000	—	UL, CSA, TÜV, CQC
RXEF005-2	—	3,000	—	15,000	—	UL, CSA, TÜV, CQC
RXEF005-AP	—	—	2,000	10,000	—	UL, CSA, TÜV, CQC
RXEF010	500	—	—	10,000	X10	UL, CSA, TÜV, CQC
RXEF010-2	—	3,000	—	15,000	X10	UL, CSA, TÜV, CQC
RXEF010-AP	—	—	2,000	10,000	X10	UL, CSA, TÜV, CQC
RXEF017	500	—	—	10,000	X17	UL, CSA, TÜV, CQC
RXEF017-2	—	2,500	—	12,500	X17	UL, CSA, TÜV, CQC
RXEF017-AP	—	—	2,000	10,000	X17	UL, CSA, TÜV, CQC
<b>RXEF 72V</b>						
RXEF020	500	—	—	10,000	X20	UL, CSA, TÜV, CQC
RXEF020-2	—	3,000	—	15,000	X20	UL, CSA, TÜV, CQC
RXEF020-AP	—	—	2,000	10,000	X20	UL, CSA, TÜV, CQC
RXEF025	500	—	—	10,000	X25	UL, CSA, TÜV, CQC
RXEF025-2	—	3,000	—	15,000	X25	UL, CSA, TÜV, CQC
RXEF025-AP	—	—	2,000	10,000	X25	UL, CSA, TÜV, CQC
RXEF030	500	—	—	10,000	X30	UL, CSA, TÜV, CQC
RXEF030-2	—	3,000	—	15,000	X30	UL, CSA, TÜV, CQC
RXEF030-AP	—	—	2,000	10,000	X30	UL, CSA, TÜV, CQC
RXEF040	500	—	—	10,000	X40	UL, CSA, TÜV, CQC
RXEF040-2	—	3,000	—	15,000	X40	UL, CSA, TÜV, CQC
RXEF040-AP	—	—	2,000	10,000	X40	UL, CSA, TÜV, CQC
RXEF050	500	—	—	10,000	X50	UL, CSA, TÜV, CQC
RXEF050-2	—	3,000	—	15,000	X50	UL, CSA, TÜV, CQC
RXEF050-AP	—	—	2,000	10,000	X50	UL, CSA, TÜV, CQC
RXEF065	500	—	—	10,000	X65	UL, CSA, TÜV, CQC
RXEF065-2	—	3,000	—	15,000	X65	UL, CSA, TÜV, CQC
RXEF065-AP	—	—	2,000	10,000	X65	UL, CSA, TÜV, CQC
RXEF075	500	—	—	10,000	X75	UL, CSA, TÜV, CQC
RXEF075-2	—	3,000	—	15,000	X75	UL, CSA, TÜV, CQC
RXEF075-AP	—	—	2,000	10,000	X75	UL, CSA, TÜV, CQC
RXEF090	500	—	—	10,000	X90	UL, CSA, TÜV, CQC
RXEF090-2	—	3,000	—	15,000	X90	UL, CSA, TÜV, CQC
RXEF090-AP	—	—	2,000	10,000	X90	UL, CSA, TÜV, CQC
RXEF110	500	—	—	10,000	X110	UL, CSA, TÜV, CQC
RXEF110-2	—	1,500	—	7,500	X110	UL, CSA, TÜV, CQC
RXEF110-AP	—	—	1,000	5,000	X110	UL, CSA, TÜV, CQC
RXEF135	500	—	—	10,000	X135	UL, CSA, TÜV, CQC
RXEF135-2	—	1,500	—	7,500	X135	UL, CSA, TÜV, CQC
RXEF135-AP	—	—	1,000	5,000	X135	UL, CSA, TÜV, CQC
RXEF160	500	—	—	10,000	X160	UL, CSA, TÜV, CQC
RXEF160-2	—	1,500	—	7,500	X160	UL, CSA, TÜV, CQC
RXEF160-AP	—	—	1,000	5,000	X160	UL, CSA, TÜV, CQC
RXEF185	500	—	—	10,000	X185	UL, CSA, TÜV, CQC
RXEF185-2	—	1,500	—	7,500	X185	UL, CSA, TÜV, CQC
RXEF185-AP	—	—	1,000	5,000	X185	UL, CSA, TÜV, CQC
RXEF250	250	—	—	5,000	X250	UL, CSA, TÜV, CQC
RXEF250-2	—	1,000	—	5,000	X250	UL, CSA, TÜV, CQC
RXEF250-AP	—	—	1,000	5,000	X250	UL, CSA, TÜV, CQC

# PolySwitch Resettable Devices

## Radial-Leaded Devices

### Table R6 – Packaging and Marking Information

(Cont'd)

Part Number	Bag Quantity	Tape and Reel Quantity	Ammo Pack Quantity	Standard Package Quantity	Part Marking	Agency Recognition
<b>RXEF</b>						
<b>72V</b>						
RXEF300	250	—	—	5,000	X300	UL, CSA, TÜV, CQC
RXEF300-2	—	1,000	—	5,000	X300	UL, CSA, TÜV, CQC
RXEF300-AP	—	—	1,000	5,000	X300	UL, CSA, TÜV, CQC
RXEF375	250	—	—	5,000	X375	UL, CSA, TÜV, CQC
<b>RKEF</b>						
<b>60V</b>						
RKEF050	500	—	—	10,000	K50	UL, CSA, TÜV
RKEF065	500	—	—	10,000	K65	UL, CSA, TÜV
RKEF075	500	—	—	10,000	K75	UL, CSA, TÜV
RKEF090	500	—	—	10,000	K90	UL, CSA, TÜV
RKEF110	500	—	—	10,000	K110	UL, CSA, TÜV
RKEF135	500	—	—	10,000	K135	UL, CSA, TÜV
RKEF160	500	—	—	10,000	K160	UL, CSA, TÜV
RKEF185	500	—	—	10,000	K185	UL, CSA, TÜV
RKEF250	500	—	—	10,000	K250	UL, CSA, TÜV
RKEF300	250	—	—	5,000	K300	UL, CSA, TÜV
RKEF375	250	—	—	5,000	K375	UL, CSA, TÜV
RKEF400	250	—	—	5,000	K400	UL, CSA, TÜV
RKEF500	250	—	—	5,000	K500	UL, CSA, TÜV
<b>RUEF</b>						
<b>30V</b>						
RUEF090	500	—	—	10,000	U90	UL, CSA, TÜV, CQC
RUEF090-2	—	3,000	—	15,000	U90	UL, CSA, TÜV, CQC
RUEF090-AP	—	—	2,000	10,000	U90	UL, CSA, TÜV, CQC
RUEF110	500	—	—	10,000	U110	UL, CSA, TÜV, CQC
RUEF110-2	—	3,000	—	15,000	U110	UL, CSA, TÜV, CQC
RUEF110-AP	—	—	2,000	10,000	U110	UL, CSA, TÜV, CQC
RUEF135	500	—	—	10,000	U135	UL, CSA, TÜV, CQC
RUEF135-2	—	3,000	—	15,000	U135	UL, CSA, TÜV, CQC
RUEF135-AP	—	—	2,000	10,000	U135	UL, CSA, TÜV, CQC
RUEF160	500	—	—	10,000	U160	UL, CSA, TÜV, CQC
RUEF160-2	—	3,000	—	15,000	U160	UL, CSA, TÜV, CQC
RUEF160-AP	—	—	2,000	10,000	U160	UL, CSA, TÜV, CQC
RUEF185	500	—	—	10,000	U185	UL, CSA, TÜV, CQC
RUEF185-2	—	3,000	—	15,000	U185	UL, CSA, TÜV, CQC
RUEF185-AP	—	—	2,000	10,000	U185	UL, CSA, TÜV, CQC
RUEF250	500	—	—	10,000	U250	UL, CSA, TÜV, CQC
RUEF250-2	—	3,000	—	15,000	U250	UL, CSA, TÜV, CQC
RUEF250-AP	—	—	2,000	10,000	U250	UL, CSA, TÜV, CQC
RUEF300	500	—	—	10,000	U300	UL, CSA, TÜV, CQC
RUEF300-2	—	2,500	—	12,500	U300	UL, CSA, TÜV, CQC
RUEF300-AP	—	—	1,000	5,000	U300	UL, CSA, TÜV, CQC
RUEF400	500	—	—	10,000	U400	UL, CSA, TÜV, CQC
RUEF400-2	—	1,500	—	7,500	U400	UL, CSA, TÜV, CQC
RUEF400-AP	—	—	1,000	5,000	U400	UL, CSA, TÜV, CQC
RUEF500	250	—	—	5,000	U500	UL, CSA, TÜV, CQC
RUEF500-2	—	1,500	—	7,500	U500	UL, CSA, TÜV, CQC
RUEF500-AP	—	—	1,000	5,000	U500	UL, CSA, TÜV, CQC
RUEF600	250	—	—	5,000	U600	UL, CSA, TÜV, CQC
RUEF600-2	—	1,000	—	5,000	U600	UL, CSA, TÜV, CQC

# PolySwitch Resettable Devices

## Radial-Leaded Devices

### Table R6 — Packaging and Marking Information

(Cont'd)

Part Number	Bag Quantity	Tape and Reel Quantity	Ammo Pack Quantity	Standard Package Quantity	Part Marking	Agency Recognition
<b>RUEF</b>						
<b>30V</b>						
RUEF600-AP	—	—	1,000	5,000	U600	UL, CSA, TÜV, CQC
RUEF700	250	—	—	5,000	U700	UL, CSA, TÜV, CQC
RUEF700-2	—	1,000	—	5,000	U700	UL, CSA, TÜV, CQC
RUEF700-AP	—	—	1,000	5,000	U700	UL, CSA, TÜV, CQC
RUEF800	250	—	—	5,000	U800	UL, CSA, TÜV, CQC
RUEF800-2	—	1,000	—	5,000	U800	UL, CSA, TÜV, CQC
RUEF800-AP	—	—	1,000	5,000	U800	UL, CSA, TÜV, CQC
RUEF900	250	—	—	5,000	U900	UL, CSA, TÜV, CQC
RUEF900-2	—	1,000	—	4,000	U900	UL, CSA, TÜV, CQC
RUEF900-AP	—	—	1,000	4,000	U900	UL, CSA, TÜV, CQC
<b>RHEF</b>						
<b>30V - High Temperature</b>						
RHEF050	500	—	—	10,000	H0.5	UL, CSA, TÜV
RHEF050-2	—	2,500	—	12,500	H0.5	UL, CSA, TÜV
RHEF070	500	—	—	10,000	H0.7	UL, CSA, TÜV
RHEF070-2	—	2,500	—	12,500	H0.7	UL, CSA, TÜV
RHEF100	500	—	—	10,000	H1	UL, CSA, TÜV
RHEF100-2	—	2,500	—	12,500	H1	UL, CSA, TÜV
<b>RUSBF</b>						
<b>16V</b>						
RUSBF090	500	—	—	10,000	R90	UL, CSA, TÜV
RUSBF090-2	—	3,000	—	15,000	R90	UL, CSA, TÜV
RUSBF090-AP	—	—	2,000	10,000	R90	UL, CSA, TÜV
RUSBF110	500	—	—	10,000	R110	UL, CSA, TÜV
RUSBF110-2	—	3,000	—	15,000	R110	UL, CSA, TÜV
RUSBF110-AP	—	—	2,000	10,000	R110	UL, CSA, TÜV
RUSBF135	500	—	—	10,000	R135	UL, CSA, TÜV
RUSBF135-2	—	3,000	—	15,000	R135	UL, CSA, TÜV
RUSBF135-AP	—	—	2,000	10,000	R135	UL, CSA, TÜV
RUSBF160	500	—	—	10,000	R160	UL, CSA, TÜV
RUSBF160-2	—	3,000	—	15,000	R160	UL, CSA, TÜV
RUSBF160-AP	—	—	2,000	10,000	R160	UL, CSA, TÜV
RUSBF185	500	—	—	10,000	R185	UL, CSA, TÜV
RUSBF185-2	—	3,000	—	15,000	R185	UL, CSA, TÜV
RUSBF185-AP	—	—	2,000	10,000	R185	UL, CSA, TÜV
RUSBF250	500	—	—	10,000	R250	UL, CSA, TÜV
RUSBF250-2	—	3,000	—	15,000	R250	UL, CSA, TÜV
RUSBF250-AP	—	—	2,000	10,000	R250	UL, CSA, TÜV
<b>RGEF</b>						
<b>16V</b>						
RGEF250	500	—	—	10,000	G2.5	UL, CSA, TÜV
RGEF250-2	—	3,000	—	15,000	G2.5	UL, CSA, TÜV
RGEF250-AP	—	—	2,000	10,000	G2.5	UL, CSA, TÜV
RGEF300	500	—	—	10,000	G3	UL, CSA, TÜV
RGEF300-2	—	2,500	—	12,500	G3	UL, CSA, TÜV
RGEF300-AP	—	—	2,000	10,000	G3	UL, CSA, TÜV
RGEF400	500	—	—	10,000	G4	UL, CSA, TÜV
RGEF400-2	—	2,500	—	12,500	G4	UL, CSA, TÜV
RGEF400-AP	—	—	2,000	10,000	G4	UL, CSA, TÜV
RGEF500	500	—	—	10,000	G5	UL, CSA, TÜV

# PolySwitch Resettable Devices

## Radial-Leaded Devices

Table R6 — Packaging and Marking Information

(Cont'd)

Part Number	Bag Quantity	Tape and Reel Quantity	Ammo Pack Quantity	Standard Package Quantity	Part Marking	Agency Recognition
<b>RGEF</b>						
<b>16V</b>						
RGEF500-2	—	2,000	—	10,000	G5	UL, CSA, TÜV
RGEF500-AP	—	—	2,000	10,000	G5	UL, CSA, TÜV
RGEF600	500	—	—	10,000	G6	UL, CSA, TÜV
RGEF600-2	—	2,000	—	10,000	G6	UL, CSA, TÜV
RGEF600-AP	—	—	2,000	10,000	G6	UL, CSA, TÜV
RGEF700	500	—	—	10,000	G7	UL, CSA, TÜV
RGEF700-2	—	1,500	—	7,500	G7	UL, CSA, TÜV
RGEF700-AP	—	—	1,500	7,500	G7	UL, CSA, TÜV
RGEF800	500	—	—	10,000	G8	UL, CSA, TÜV
RGEF800-2	—	1,500	—	7,500	G8	UL, CSA, TÜV
RGEF800-AP	—	—	1,500	7,500	G8	UL, CSA, TÜV
RGEF900	500	—	—	10,000	G9	UL, CSA, TÜV
RGEF900-2	—	1,000	—	5,000	G9	UL, CSA, TÜV
RGEF900-AP	—	—	1,000	5,000	G9	UL, CSA, TÜV
RGEF1000	250	—	—	5,000	G10	UL, CSA, TÜV
RGEF1000-2	—	1,000	—	5,000	G10	UL, CSA, TÜV
RGEF1000-AP	—	—	1,000	5,000	G10	UL, CSA, TÜV
RGEF1100	250	—	—	5,000	G11	UL, CSA, TÜV
RGEF1100-2	—	1,000	—	5,000	G11	UL, CSA, TÜV
RGEF1100-AP	—	—	1,000	5,000	G11	UL, CSA, TÜV
RGEF1200	250	—	—	5,000	G12	UL, CSA, TÜV
RGEF1200-2	—	1,000	—	5,000	G12	UL, CSA, TÜV
RGEF1200-AP	—	—	1,000	5,000	G12	UL, CSA, TÜV
RGEF1400	250	—	—	5,000	G14	UL, CSA, TÜV
RGEF1400-2	—	1,000	—	5,000	G14	UL, CSA, TÜV
RGEF1400-AP	—	—	1,000	5,000	G14	UL, CSA, TÜV
<b>RHEF</b>						
<b>16V - High Temperature</b>						
RHEF200	500	—	—	10,000	H2	UL, CSA, TÜV
RHEF200-2	—	2,500	—	12,500	H2	UL, CSA, TÜV
RHEF200-AP	—	—	2,500	12,500	H2	UL, CSA, TÜV
RHEF300	500	—	—	10,000	H3	UL, CSA, TÜV
RHEF300-2	—	2,000	—	10,000	H3	UL, CSA, TÜV
RHEF300-AP	—	—	2,000	10,000	H3	UL, CSA, TÜV
RHEF400	500	—	—	10,000	H4	UL, CSA, TÜV
RHEF400-2	—	1,500	—	7,500	H4	UL, CSA, TÜV
RHEF400-AP	—	—	1,500	7,500	H4	UL, CSA, TÜV
RHEF450	500	—	—	10,000	H4.5	UL, CSA, TÜV
RHEF450-2	—	1,500	—	7,500	H4.5	UL, CSA, TÜV
RHEF450-AP	—	—	1,500	7,500	H4.5	UL, CSA, TÜV
RHEF550	500	—	—	10,000	H5.5	UL, CSA, TÜV
RHEF550-2	—	2,000	—	10,000	H5.5	UL, CSA, TÜV
RHEF550-AP	—	—	2,000	10,000	H5.5	UL, CSA, TÜV
RHEF600	500	—	—	10,000	H6	UL, CSA, TÜV
RHEF600-2	—	2,000	—	10,000	H6	UL, CSA, TÜV
RHEF600-AP	—	—	2,000	10,000	H6	UL, CSA, TÜV
RHEF650	500	—	—	10,000	H6.5	UL, CSA, TÜV
RHEF650-2	—	1,500	—	7,500	H6.5	UL, CSA, TÜV
RHEF650-AP	—	—	1,500	7,500	H6.5	UL, CSA, TÜV
RHEF700	500	—	—	10,000	H7	UL, CSA, TÜV

# PolySwitch Resettable Devices

## Radial-Leaded Devices

Table R6 — Packaging and Marking Information

(Cont'd)

Part Number	Bag Quantity	Tape and Reel Quantity	Ammo Pack Quantity	Standard Package Quantity	Part Marking	Agency Recognition
<b>RHEF</b>						
<b>16V - High Temperature</b>						
RHEF700-2	—	1,500	—	7,500	H7	UL, CSA, TÜV
RHEF700-AP	—	—	1,500	7,500	H7	UL, CSA, TÜV
RHEF750	500	—	—	10,000	H7.5	UL, CSA, TÜV
RHEF750-2	—	1,000	—	5,000	H7.5	UL, CSA, TÜV
RHEF750-AP	—	—	1,000	5,000	H7.5	UL, CSA, TÜV
RHEF800	500	—	—	10,000	H8	UL, CSA, TÜV
RHEF800-2	—	1,000	—	5,000	H8	UL, CSA, TÜV
RHEF800-AP	—	—	1,000	5,000	H8	UL, CSA, TÜV
RHEF900	250	—	—	5,000	H9	UL, CSA, TÜV
RHEF900-2	—	1,000	—	5,000	H9	UL, CSA, TÜV
RHEF900-AP	—	—	1,000	5,000	H9	UL, CSA, TÜV
RHEF1000	250	—	—	5,000	H10	UL, CSA, TÜV
RHEF1000-2	—	1,000	—	5,000	H10	UL, CSA, TÜV
RHEF1000-AP	—	—	1,000	5,000	H10	UL, CSA, TÜV
RHEF1100	250	—	—	5,000	H11	UL, CSA, TÜV
RHEF1100-2	—	1,000	—	5,000	H11	UL, CSA, TÜV
RHEF1100-AP	—	—	1,000	5,000	H11	UL, CSA, TÜV
RHEF1300	250	—	—	5,000	H13	UL, CSA, TÜV
RHEF1300-2	—	1,000	—	5,000	H13	UL, CSA, TÜV
RHEF1300-AP	—	—	1,000	5,000	H13	UL, CSA, TÜV
RHEF1400	250	—	—	5,000	H14	UL, CSA, TÜV
RHEF1400-2	—	1,000	—	5,000	H14	UL, CSA, TÜV
RHEF1400-AP	—	—	1,000	5,000	H14	UL, CSA, TÜV
RHEF1500	250	—	—	5,000	H15	UL, CSA, TÜV
RHEF1500-2	—	1,000	—	5,000	H15	UL, CSA, TÜV
RHEF1500-AP	—	—	1,000	5,000	H15	UL, CSA, TÜV
<b>RUSBF</b>						
<b>6V</b>						
RUSBF075	500	—	—	10,000	R75	UL, CSA, TÜV
RUSBF075-2	—	3,000	—	15,000	R75	UL, CSA, TÜV
RUSBF075-AP	—	—	2,000	10,000	R75	UL, CSA, TÜV
RUSBF120	500	—	—	10,000	R120	UL, CSA, TÜV
RUSBF120-2	—	3,000	—	15,000	R120	UL, CSA, TÜV
RUSBF120-AP	—	—	2,000	10,000	R120	UL, CSA, TÜV
RUSBF155	500	—	—	10,000	R155	UL, CSA, TÜV
RUSBF155-2	—	3,000	—	15,000	R155	UL, CSA, TÜV
RUSBF155-AP	—	—	2,000	10,000	R155	UL, CSA, TÜV

## Agency Recognitions

UL	File # E74889
CSA	File # CA78165
TÜV	Certificate number available on request (per IEC 60730-1).

# PolySwitch Resettable Devices

## Radial-Leaded Devices

### Table R7 — Tape and Reel Specifications

RXEF and RKEF devices are available in tape and reel packaging per EIA468-B/IEC60286-2 standards.

Description	EIA Mark	Dimension (mm)	Tolerance
Carrier Tape Width	W	18	-0.5/+1.0
Hold-Down Tape Width	W <sub>4</sub>	11	Minimum
Top Distance between Tape Edges	W <sub>6</sub>	3	Maximum
Sprocket Hole Position	W <sub>5</sub>	9	-0.5/+0.75
Sprocket Hole Diameter	D <sub>0</sub>	4	± 0.2
Abscissa to Plane (Straight Lead) (RXEF110 To RXEF300, RKEF135 To RKEF500)	H	18.5	± 2.5
Abscissa to Plane (Kinked Lead) (RXEF010 To RXEF090, RKEF050 To RKEF110)	H <sub>0</sub>	16.0	± 0.5
Abscissa to Top (RXEF010 To RXEF090, RKEF050 To RKEF185)	H <sub>1</sub>	32.2	Maximum
Abscissa to Top* (RXEF110 To RXEF300, RKEF250 To RKEF500)	H <sub>1</sub>	47.5	Maximum
Overall Width with Lead Protrusion (RXEF010 To RXEF090, RKEF050 To RKEF185)	C <sub>1</sub>	43.2	Maximum
Overall Width with Lead Protrusion* (RXEF110 To RXEF300, RKEF250 To RKEF500)	C <sub>1</sub>	58	Maximum
Overall Width without Lead Protrusion (RXEF010 To RXEF090, RKEF050 To RKEF185)	C <sub>2</sub>	42.5	Maximum
Overall Width without Lead Protrusion* (RXEF110 To RXEF300, RKEF250 To RKEF500)	C <sub>2</sub>	57	Maximum
Lead Protrusion	L <sub>1</sub>	1.0	Maximum
Protrusion of Cut-Out	L	11.0	Maximum
Protrusion beyond Hold-down Tape	I <sub>2</sub>	Not Specified	—
Sprocket Hole Pitch	P <sub>0</sub>	12.7	± 0.3
Device Pitch (RXEF010 To RXEF090, RKEF050 To RKEF185)	—	12.7	± 0.3
Device Pitch (RXEF110 To RXEF300, RKEF250 To RKEF500)	—	25.4	± 0.61
Pitch Tolerance	—	20 Consecutive	± 1
Tape Thickness	T	0.9	Maximum
Overall Tape and Lead Thickness (RXEF010 To RXEF090, RKEF050 To RKEF185)	T <sub>1</sub>	1.5	Maximum
Overall Tape and Lead Thickness (RXEF110 To RXEF300, RKEF250 To RKEF500)	T <sub>1</sub>	2.3	Maximum
Splice Sprocket Hole Alignment	—	0	± 0.3
Body Lateral Deviation	Dh	0	± 1.0
Body Tape Plane Deviation	Dp	0	± 1.3
Ordinate to Adjacent Component Lead (RXEF010 To RXEF185, RKEF050 To RKEF300)	P <sub>1</sub>	3.81	± 0.7
Ordinate to Adjacent Component Lead (RXEF250 To RXEF300, RKEF375 To RKEF500)	P <sub>1</sub>	7.62	± 0.7
Lead Spacing* (RXEF010 To RXEF185, RKEF050 To RKEF300)	F	5.05	± 0.75
Lead Spacing* (RXEF250 To RXEF300, RKEF375 To RKEF500)	F	10.15	± 0.75
Reel Width (RXEF010 To RXEF090, RKEF050 To RKEF185)	W <sub>2</sub>	56.0	Maximum
Reel Width* (RXEF110 To RXEF300, RKEF250 To RKEF500)	W <sub>2</sub>	63.5	Maximum
Reel Diameter	A	370.0	Maximum
Space between Flanges* (RXEF010 To RXEF090, RKEF050 To RKEF185)	W <sub>1</sub>	48.00	Maximum
Space between Flanges* (RXEF110 To RXEF300, RKEF250 To RKEF500)	W <sub>1</sub>	55.00	Maximum
Arbor Hold Diameter	C	26.0	± 12.0
Core Diameter*	N	91.0	Maximum
Box	—	64/372/362	Maximum
Consecutive Missing Places	—	None	—
Empty Places per Reel	—	0.1%	Maximum

\*Differs from EIA specification.

# PolySwitch Resettable Devices

## Radial-Leaded Devices

### Table R7 — Tape and Reel Specifications

(Cont'd)

RUEF and RUSBF devices are available in tape and reel packaging per EIA468-B/IEC60286-2 standards.

Description	EIA Mark	Dimension (mm)	Tolerance
Carrier Tape Width	W	18	-0.5/+1.0
Hold-down Tape Width	W <sub>4</sub>	11	Minimum
Top Distance between Tape Edges	W <sub>6</sub>	3	Maximum
Sprocket Hole Position	W <sub>5</sub>	9	-0.5/+0.75
Sprocket Hole Diameter	D <sub>0</sub>	4	± 0.2
Abscissa to Plane (Straight Lead)* (RUEF300 to RUEF900)	H	18.5	± 2.5
Abscissa to Plane (Kinked Lead) (RUSBF075 to RUSBF250, RUEF090 to RUEF250)	H <sub>0</sub>	16.0	± 0.5
Abscissa to Top (RUSBF075 to RUSBF250, RUEF090 to RUEF300)	H <sub>1</sub>	38.5	Maximum
Abscissa to Top* (RUEF400 to RUEF900)	H <sub>1</sub>	45.0	Maximum
Overall Width with Lead Protrusion (RUSBF075 to RUSBF250, RUEF090 to RUEF300)	C <sub>1</sub>	43.2	Maximum
Overall Width with Lead Protrusion (RUEF400 To RUEF900)	C <sub>1</sub>	56	Maximum
Overall Width without Lead Protrusion (RUSBF075 to RUSBF250, RUEF090 to RUEF300)	C <sub>2</sub>	42.5	Maximum
Overall Width without Lead Protrusion (RUEF400 to RUEF900)	C <sub>2</sub>	56	Maximum
Lead Protrusion	L <sub>1</sub>	1.0	Maximum
Protrusion of Cut-out	L	11	Maximum
Protrusion beyond Hold-down Tape	I <sub>2</sub>	Not Specified	—
Sprocket Hole Pitch	P <sub>0</sub>	12.7	± 0.3
Device Pitch (RUSBF075 to RUSBF250, RUEF090 to RUEF300)	—	12.7	± 0.3
Device Pitch (RUEF400 to RUEF900)	—	25.4	± 0.6
Pitch Tolerance	—	20 Consecutive	± 1
Tape Thickness	T	0.9	Maximum
Overall Tape and Lead Thickness (RUSBF075 to RUSBF250, RUEF090 to RUEF50)	T <sub>1</sub>	1.5	Maximum
Overall Tape and Lead Thickness* (RUEF300 to RUEF900)	T <sub>1</sub>	2.3	Maximum
Splice Sprocket Hole Alignment	—	0	± 0.3
Body Lateral Deviation	Dh	0	± 1.0
Body Tape Plane Deviation	Dp	0	± 1.3
Ordinate to Adjacent Component Lead (RUSBF075 to RUSBF250, RUEF090 to RUEF300)	P <sub>1</sub>	3.81	± 0.7
Ordinate to Adjacent Component Lead (RUEF400 to RUEF900)	P <sub>1</sub>	7.62	± 0.7
Lead Spacing* (RUSBF075 to RUSBF250, RUEF090 to RUEF400)	F	5.05	± 0.75
Lead Spacing* (RUEF500 to RUEF900)	F	10.15	± 0.75
Reel Width (RUEF090 to RUEF400, RUSBF075 to RUSBF250)	W <sub>2</sub>	56.0	Maximum
Reel Width (RUEF500* to RUEF900)	W <sub>2</sub>	63.5	Maximum
Reel Diameter	A	370.0	Maximum
Space between Flanges* (RUEF090 to RUEF400, RUSBF075 to RUSBF250)	W <sub>1</sub>	48.0	Maximum
Space between Flanges* (RUEF500 to RUEF900)	W <sub>1</sub>	55.0	Maximum
Arbor Hold Diameter	C	26.0	± 12.0
Core Diameter*	N	91.0	Maximum
Box	—	64/372/362	Maximum
Consecutive Missing Places	—	None	—
Empty Places per Reel	—	0.1%	Maximum

\*Differs from EIA specification.

# PolySwitch Resettable Devices

## Radial-Leaded Devices

### Table R7 — Tape and Reel Specifications

(Cont'd)

RGEF and RHEF devices are available in tape and reel packaging per EIA468–B/IEC60286–2 standards.

Description	EIA Mark	Dimension (mm)	Tolerance
Carrier Tape Width	W	18	-0.5/+1.0
Hold-Down Tape Width	W <sub>4</sub>	11	Minimum
Top Distance between Tape Edges	W <sub>6</sub>	3	Maximum
Sprocket Hole Position	W <sub>5</sub>	9	-0.5/+0.75
Sprocket Hole Diameter	D <sub>0</sub>	4	± 0.2
Abscissa to Plane (Straight Lead) (RGEF250 to RGEF1400)	H	18.5	± 2.5
Abscissa to Plane (Kinked Lead) (RHEF050 to RGEF1500)	H <sub>0</sub>	16.0	± 0.5
Abscissa to Top (RGEF250 to RGEF500, RGEF050 to RGEF450)	H <sub>1</sub>	38.5	Maximum
Abscissa to Top* (RGEF600 to RGEF1400, RHEF550 to RHEF1500)	H <sub>1</sub>	45.0	Maximum
Overall Width with Lead Protrusion (RGEF250 to RGEF600, RHEF050 to RHEF450)	C <sub>1</sub>	43.2	Maximum
Overall Width with Lead Protrusion (RGEF700 to RGEF1400, RHEF550 to RHEF1500)	C <sub>1</sub>	55	Maximum
Overall Width without Lead Protrusion (RGEF250 to RGEF600, RHEF050 to RHEF450)	C <sub>2</sub>	42.5	Maximum
Overall Width without Lead Protrusion (RGEF700 to RGEF1400, RHEF550 to RHEF1500)	C <sub>2</sub>	54	Maximum
Lead Protrusion	L <sub>1</sub>	1.0	Maximum
Protrusion of Cut-out	L	11	Maximum
Protrusion beyond Hold-down Tape	I <sub>2</sub>	Not Specified	—
Sprocket Hole Pitch	P <sub>0</sub>	12.7	± 0.3
Device Pitch (RGEF250 to RGEF700, RHEF050 to RHEF600)	—	25.4	± 0.61
Device Pitch (RGEF800 to RGEF1400, RHEF650 to RHEF1500)	—	25.4	± 0.6
Pitch Tolerance	—	20 Consecutive	± 1
Tape Thickness	T	0.9	Maximum
Overall Tape and Lead Thickness* (RGEF250 to RGEF1100, RHEF050 to RHEF1100)	T <sub>1</sub>	2.0	Maximum
Overall Tape and Lead Thickness* (RGEF1200 to RGEF1400, RHEF1300 to RHEF1500)	T <sub>1</sub>	2.3	Maximum
Splice Sprocket Hole Alignment	—	0	± 0.3
Body Lateral Deviation	Dh	0	± 1.0
Body Tape Plane Deviation	Dp	0	± 1.3
Ordinate to Adjacent Component Lead (RGEF250 to RGEF1100, RHEF050 to RHEF900)	P <sub>1</sub>	3.81	± 0.7
Ordinate to Adjacent Component Lead (RGEF1200 to RGEF1400, RHEF1000 to RHEF1500)	P <sub>1</sub>	7.62	± 0.7
Lead Spacing* (RGEF250 to RGEF1100, RHEF050 to RHEF900)	F	5.05	± 0.75
Lead Spacing* (RGEF1200 to RGEF1400, RHEF1000 to RHEF1500)	F	10.15	± 0.75
Reel Width (RGEF250 to RGEF600, RHEF050 to RHEF450)	W <sub>2</sub>	56.0	Maximum
Reel Width* (RGEF700 to RGEF1400 & RHEF550 to RHEF1500)	W <sub>2</sub>	63.5	Maximum
Reel Diameter	A	370.0	Maximum
Space between Flanges* (RGEF250 to RGEF600, RHEF050 to RHEF450)	W <sub>1</sub>	48.0	Maximum
Space between Flanges* (RGEF700 to RGEF400, RHEF550 to RHEF1500)	W <sub>1</sub>	55.0	Maximum
Arbor Hold Diameter	C	26.0	± 12.0
Core Diameter*	N	91.0	Maximum
Box	—	64/372/362	Maximum
Consecutive Missing Places	—	None	—
Empty Places per Reel	—	0.1%	Maximum

\*Differs from EIA specification.

# PolySwitch Resettable Devices

## Radial-Leaded Devices

Figure R21 — EIA Referenced Taped Component Dimensions

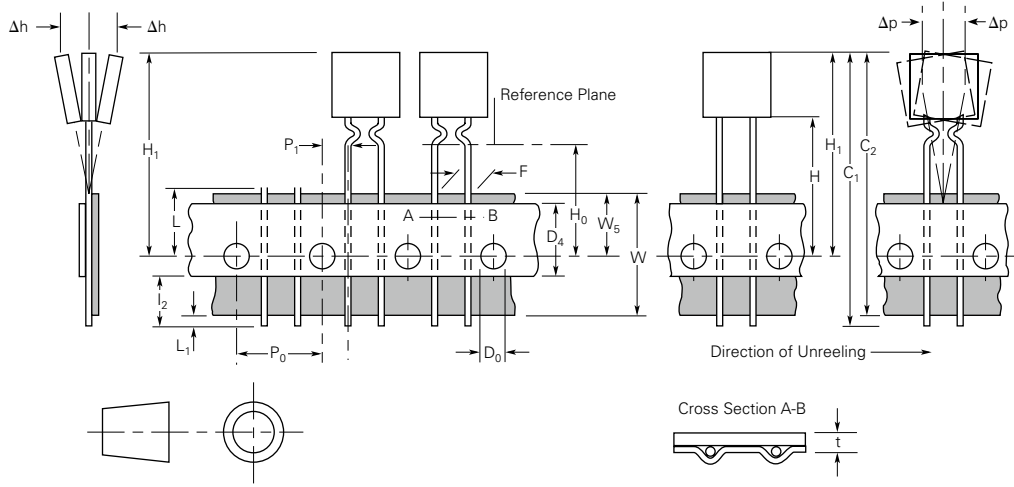
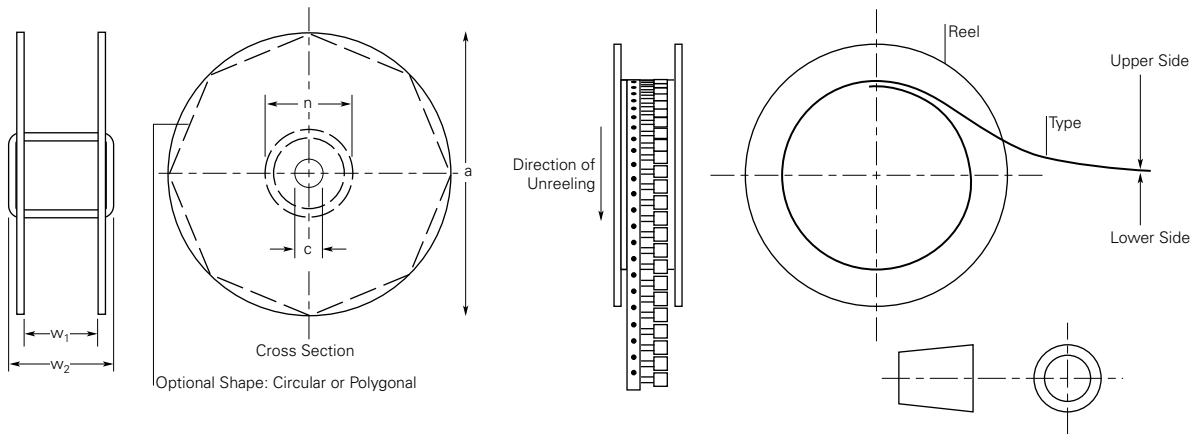

Figure R22 — EIA Referenced Reel Dimensions



# PolySwitch Resettable Devices

## Radial-Leaded Devices

### Part Numbering System

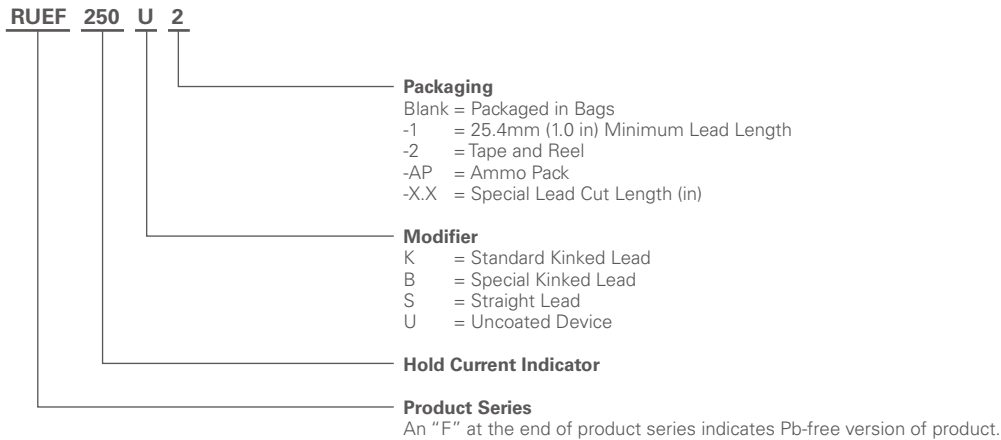

**Note:** Kinked parts are recommended to control the height of the part on the PCB in non-auto PCB applications.



### Warning :

- Users should independently evaluate the suitability of and test each product selected for their own application.
- Operation beyond the maximum ratings or improper use may result in device damage and possible electrical arcing and flame.
- These devices are intended for protection against damage caused by occasional overcurrent or overtemperature fault conditions and should not be used when repeated fault conditions or prolonged trip events are anticipated.
- Contamination of the PPTC material with certain silicone-based oils or some aggressive solvents can adversely impact the performance of the devices.
- Device performance can be impacted negatively if devices are handled in a manner inconsistent with recommended electronic, thermal, and mechanical procedures for electronic components.
- PPTC devices are not recommended for installation in applications where the device is constrained such that its PTC properties are inhibited, for example in rigid potting materials or in rigid housings, which lack adequate clearance to accommodate device expansion.
- Operation in circuits with a large inductance can generate a circuit voltage ( $Ldi/dt$ ) above the rated voltage of the device.

### Notice:

Information furnished is believed to be accurate and reliable. However, users should independently evaluate the suitability of and test each product selected for their own applications. Littelfuse products are not designed for, and shall not be used for, any purpose (including, without limitation, military, aerospace, medical, life-saving, life-sustaining or nuclear facility applications, devices intended for surgical implant into the body, or any other application in which the failure or lack of desired operation of the product may result in personal injury, death, or property damage) other than those expressly set forth in applicable Littelfuse product documentation. Warranties granted by Littelfuse shall be deemed void for products used for any purpose not expressly set forth in applicable Littelfuse documentation. Littelfuse shall not be liable for any claims or damages arising out of products used in applications not expressly intended by Littelfuse as set forth in applicable Littelfuse documentation. The sale and use of Littelfuse products is subject to Littelfuse Terms and Conditions of Sale, unless otherwise agreed by Littelfuse.

## Looking for pricing, stock, or lifecycle information?

Click below to explore more details on WIN SOURCE:

 [View RUEF300K on WIN SOURCE](#)

 [Littelfuse Inc. Information](#)

## Optimize Your Supply Chain with WIN SOURCE Solutions

-  Global Sourcing Solution
-  Obsolete Management
-  Cost Control Management
-  Shortage Management
-  Alternative Solution
-  Excess Inventory Management