



# THE DATASHEET OF CMS2-3-R



# CMS

## Common mode inductors, surface mount



### Product description

- Three sizes of surface mount toroidal common mode inductors that provide 300Vdc isolation
- Inductance range from 5.5uH to 1600uH
- Current range up to 7.0 Amps
- Noise attenuation up to 44 dB
- Frequency range up to 100 MHz
- Meets UL94V-0 flammability standard
- Ferrite core material

### Applications

- EMI filters
- DC-DC brick power supplies
- Discrete output supplies
- Discrete and point-of-use power supplies (PUPS)

### Environmental data

- Storage temperature range: -40°C to +160°C
- Operating ambient temperature range: -40°C to +160°C (range is application specific)
- Solder reflow temperature: J-STD-020D compliant



**Product specifications**

Part number	OCL (uH) minimum (1-2) & (4-3)	I rms. Amperes Max*	DCR (Ω) typ @ 20°C (1-2)	DCR (Ω) typ @ 20°C (4-3)	Leakage Inductance (uH) typ	Interwinding Capacitance (pF) typ
CMS1-1-R	4.5	7.00	0.0027	0.0027	0.05	2.0
CMS1-2-R	8	5.70	0.0040	0.0040	0.09	2.1
CMS1-3-R	12.6	4.10	0.077	0.077	0.14	2.2
CMS1-4-R	18	3.80	0.0089	0.0089	0.20	2.3
CMS1-5-R	25	3.60	0.0100	0.0100	0.28	2.4
CMS1-6-R	32.8	3.10	0.0138	0.0138	0.36	2.5
CMS1-7-R	41.5	2.60	0.019	0.019	0.45	2.6
CMS1-8-R	51.2	2.20	0.026	0.026	0.056	2.7
CMS1-9-R	62	1.90	0.035	0.035	0.68	2.7
CMS1-10-R	73.7	1.65	0.048	0.048	0.81	2.8
CMS1-11-R	100	1.35	0.070	0.070	1.10	3.9
CMS1-12-R	131	1.15	0.100	0.100	1.45	3.0
CMS1-13-R	166	1.00	0.138	0.138	1.83	3.1
CMS1-14-R	205	0.85	0.186	0.186	2.25	3.2
CMS2-0-R	14	6.00	0.004	0.004	0.13	1.7
CMS2-1-R	25	5.35	0.005	0.005	0.22	2.0
CMS2-2-R	40	4.40	0.008	0.008	0.34	2.3
CMS2-3-R	57	3.60	0.012	0.012	0.47	2.5
CMS2-4-R	102	2.80	0.019	0.019	0.80	2.8
CMS2-5-R	160	2.30	0.029	0.029	1.25	3.1
CMS2-6-R	230	1.85	0.044	0.044	1.75	3.4
CMS2-7-R	270	1.60	0.060	0.060	2.00	3.6
CMS2-8-R	360	1.35	0.084	0.084	2.60	3.9
CMS2-9-R	460	1.10	0.120	0.120	3.30	4.3
CMS2-10-R	575	0.94	0.170	0.170	4.00	4.3
CMS2-11-R	700	0.80	0.230	0.230	5.00	4.6
CMS2-12-R	915	0.67	0.330	0.330	6.30	4.9
CMS2-13-R	1070	0.58	0.440	0.440	7.30	5.1
CMS2-14-R	1340	0.50	0.620	0.620	9.00	5.4
CMS3-1-R	28	5.70	0.005	0.005	0.31	2.80
CMS3-2-R	45	5.10	0.006	0.006	0.46	3.05
CMS3-3-R	64	4.75	0.007	0.007	0.64	3.30
CMS3-4-R	88	3.95	0.010	0.010	0.85	3.50
CMS3-5-R	146	3.10	0.017	0.017	1.30	3.70
CMS3-6-R	217	2.85	0.020	0.020	1.90	3.90
CMS3-7-R	258	2.45	0.027	0.027	2.20	4.15
CMS3-8-R	350	2.00	0.040	0.040	3.00	4.40
CMS3-9-R	400	1.70	0.053	0.053	3.30	4.65
CMS3-10-R	518	1.45	0.076	0.076	4.20	4.85
CMS3-11-R	648	1.20	0.107	0.107	5.10	5.10
CMS3-12-R	790	1.05	0.145	0.145	6.10	5.35
CMS3-13-R	1030	0.88	0.210	0.210	7.80	5.55
CMS3-14-R	1310	0.75	0.300	0.300	9.60	5.80

**Definitions:**

OCL = Open Circuit Inductance  
DCR = Direct Current Resistance  
I<sub>rms</sub> = rms current for approx. a 40°C temperature rise at an ambient temperature of 85°C.  
\*Operating Temperature: 160°C Max. Inductance values are sustained up to 160°C.

**Electrical Characteristics:**

OCL (1-2) 0.10V<sub>rms</sub>, 100kHz, 0.0Adc: (See Chart)  
OCL (4-3) 0.10V<sub>rms</sub>, 100kHz, 0.0Adc: (See Chart)  
DCR (1-2) typ @ 20°C: (See Chart)  
DCR (4-3) typ @ 20°C: (See Chart)  
Hipot rating: winding to winding: 300Vdc min. for 1 second.  
Turns Ratio: (1-2):(4-3) 1:1

Dimensions—mm

CMS1

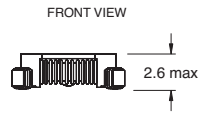
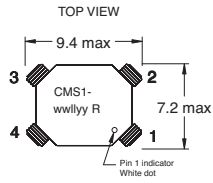

RECOMMENDED PCB LAYOUT

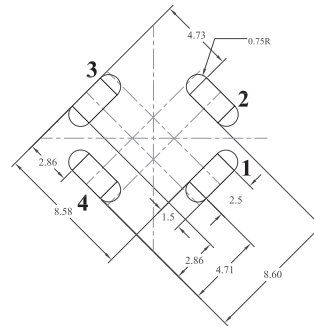

SCHEMATIC

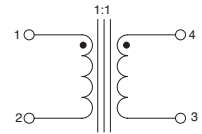

CMS2

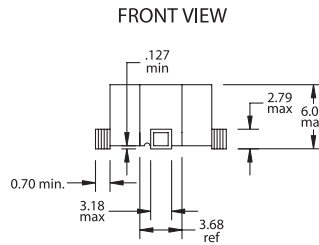
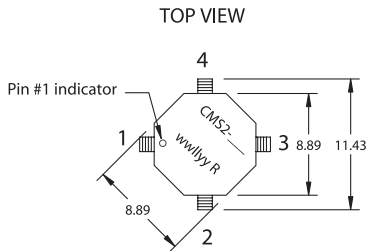

RECOMMENDED PCB LAYOUT

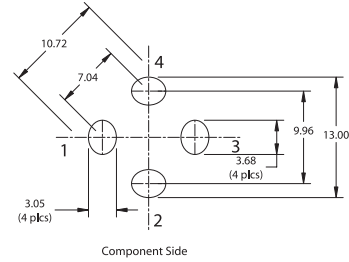

SCHEMATIC

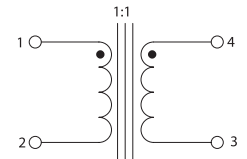

CMS3

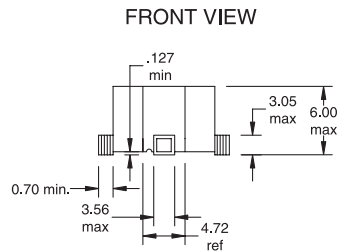
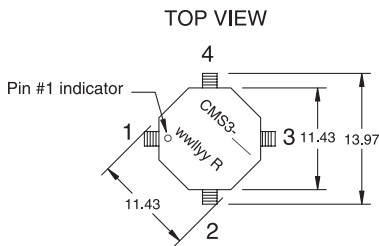

RECOMMENDED PCB LAYOUT

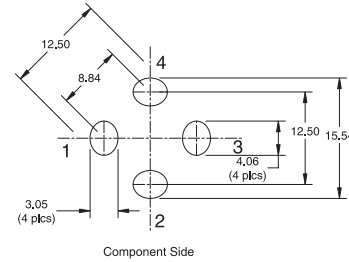

SCHEMATIC

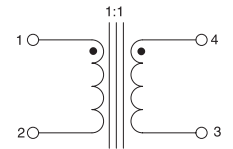

willyy = Date code R = Revision level

**Packaging Information**

**CMS1**

Supplied in tape and reel packaging, 2,000 parts per 13" diameter reel

**CMS2**

Supplied in tape and reel packaging, 800 parts per 13" diameter reel

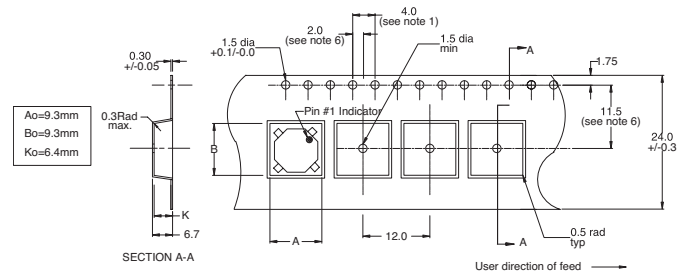
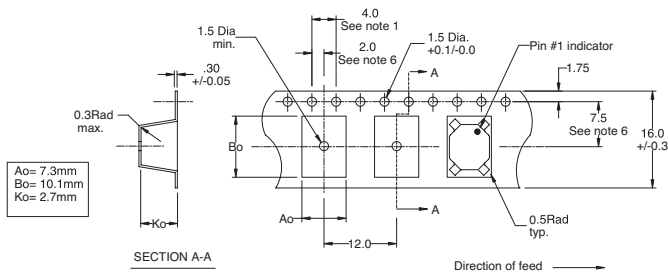

**CMS3**

Supplied in tape and reel packaging, 600 parts per 13" diameter reel

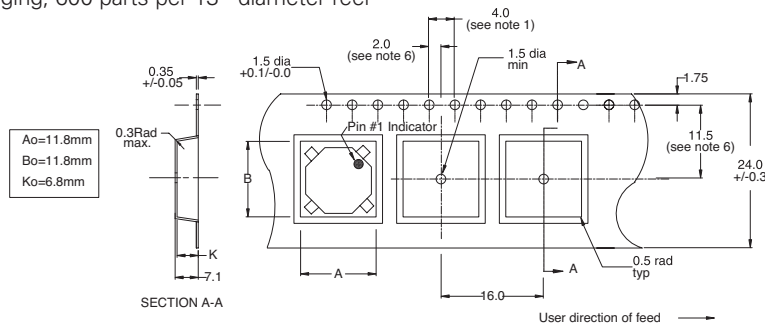

**Attenuation Curves**

**Attenuation CMS 1**

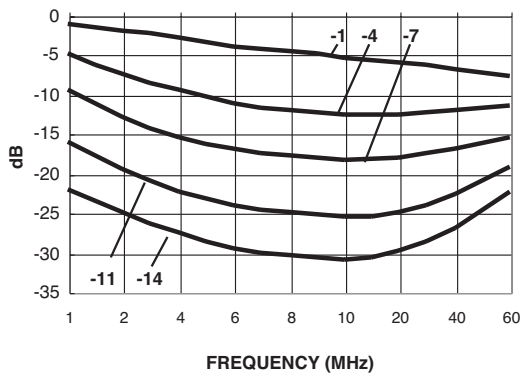

**Attenuation CMS 2**

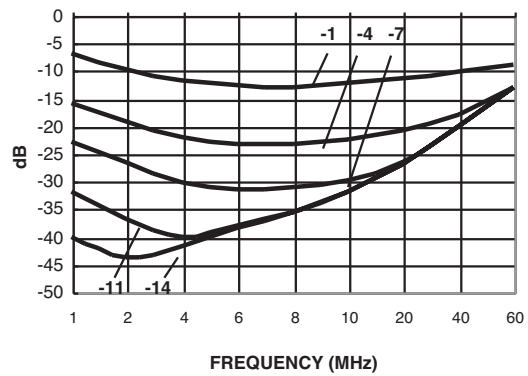

**Attenuation CMS 3**

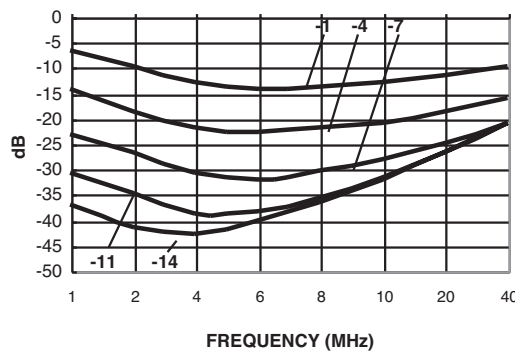

Impedance Curves

Impedance CMS1-1 & 4

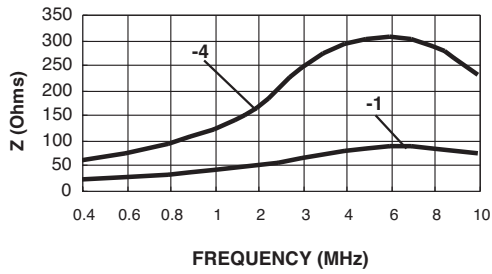

Impedance CMS1 - 7,11, & 14

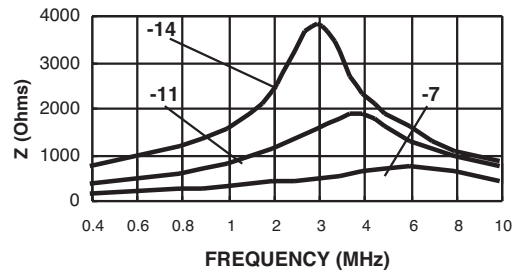

Impedance CMS2 - 1 & 4

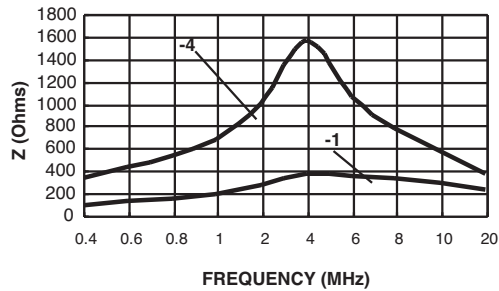

Impedance CMS2 - 7,11, & 14

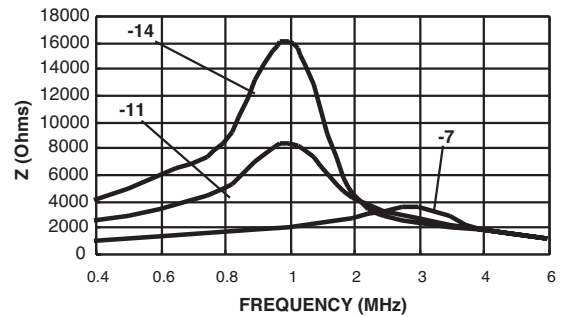

Impedance CMS3 - 1 & 4

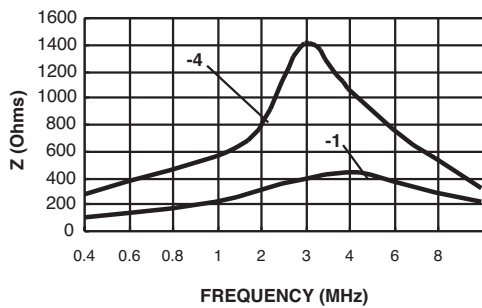

Impedance CMS3 - 7,11, & 14

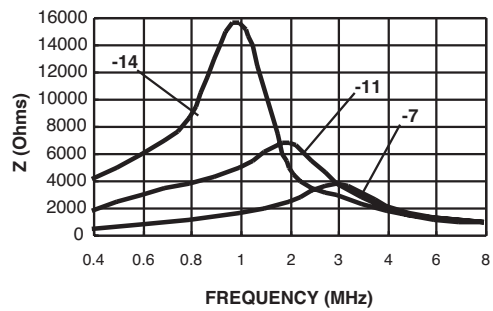

**Solder reflow profile**



**Table 1 - Standard SnPb Solder ( $T_c$ )**

Package Thickness	Volume mm <sup>3</sup> <350	Volume mm <sup>3</sup> ≥350
<2.5mm)	235°C	220°C
≥2.5mm	220°C	220°C

**Table 2 - Lead (Pb) Free Solder ( $T_c$ )**

Package Thickness	Volume mm <sup>3</sup> <350	Volume mm <sup>3</sup> 350 - 2000	Volume mm <sup>3</sup> >2000
<1.6mm	260°C	260°C	260°C
1.6 - 2.5mm	260°C	250°C	245°C
>2.5mm	250°C	245°C	245°C

**Reference JDEC J-STD-020D**

Profile Feature	Standard SnPb Solder	Lead (Pb) Free Solder
Preheat and Soak		
• Temperature min. ( $T_{smin}$ )	100°C	150°C
• Temperature max. ( $T_{smax}$ )	150°C	200°C
• Time ( $T_{smin}$ to $T_{smax}$ ) ( $t_s$ )	60-120 Seconds	60-120 Seconds
Average ramp up rate $T_{smax}$ to $T_p$	3°C/ Second Max.	3°C/ Second Max.
Liquidous temperature ( $T_L$ )	183°C	217°C
Time at liquidous ( $t_L$ )	60-150 Seconds	60-150 Seconds
Peak package body temperature ( $T_p$ )*	Table 1	Table 2
Time ( $t_p$ )** within 5 °C of the specified classification temperature ( $T_c$ )	20 Seconds**	30 Seconds**
Average ramp-down rate ( $T_p$ to $T_{smax}$ )	6°C/ Second Max.	6°C/ Second Max.
Time 25°C to Peak Temperature	6 Minutes Max.	8 Minutes Max.

\* Tolerance for peak profile temperature ( $T_p$ ) is defined as a supplier minimum and a user maximum.

\*\* Tolerance for time at peak profile temperature ( $t_p$ ) is defined as a supplier minimum and a user maximum.

Life Support Policy: Eaton does not authorize the use of any of its products for use in life support devices or systems without the express written approval of an officer of the Company. Life support systems are devices which support or sustain life, and whose failure to perform, when properly used in accordance with instructions for use provided in the labeling, can be reasonably expected to result in significant injury to the user.



Eaton reserves the right, without notice, to change design or construction of any products and to discontinue or limit distribution of any products. Eaton also reserves the right to change or update, without notice, any technical information contained in this bulletin.

**Eaton**  
**Electronics Division**  
1000 Eaton Boulevard  
Cleveland, OH 44122  
United States  
www.eaton.com/elx

© 2015 Eaton  
All Rights Reserved  
Printed in USA  
Publication No. 4313  
October 2015

## Looking for pricing, stock, or lifecycle information?

Click below to explore more details on WIN SOURCE:

-  [View CMS2-3-R on WIN SOURCE](#)
-  [Eaton Bussmann Information](#)

## Optimize Your Supply Chain with WIN SOURCE Solutions

-  Global Sourcing Solution
-  Obsolete Management
-  Cost Control Management
-  Shortage Management
-  Alternative Solution
-  Excess Inventory Management