



THE DATASHEET OF PAM8904EGPR



Description

The PAM8904E is a piezo sounder driver with integrated charge pump boost converter. The PAM8904E is capable of driving a ceramic/piezo sounder with 27V_{PP} from a 4.5V power supply. The charge pump can operate in either 1x, 2x or 3x mode.

The boost converter operates at a fixed frequency of 100kHz and provides a 3X V_{IN} output with a minimum number of external components. The PAM8904E can drive up to 47nF loading. Diodes Incorporated's unique drive technology provides a small inrush current, low EMI and high efficiency.

The PAM8904E includes built-in automatic shutdown and wake-up that guarantees longer battery life. The PAM8904E features thermal shutdown, overcurrent protection, overvoltage protection and undervoltage lockout.

The PAM8904E is available in U-QFN3030-16 (Type B), U-QFN3030-12 (Type A), W-QFN2020-12 (Type US) and U-QFN2020-12 (Type UX) packages.

Features

- Supply Voltage Range from 1.5V to 5.5V
- 18V_{PP} Output from a 3V Supply
- Integrated Boost Converter Generates up to 13.5V Supply
- Input Signal 20Hz to 300kHz
- No Voltage Cross Output in Shutdown Mode
- Low Current Consumption
- Automatic Standby and Wake-up Control
- Available in Space Saving U-QFN3030-16 (Type B), U-QFN3030-12 (Type A), W-QFN2020-12 (Type US) and U-QFN2020-12 (Type UX) Packages
- **Totally Lead-Free & Fully RoHS Compliant (Notes 1 & 2)**
- **Halogen and Antimony Free. "Green" Device (Note 3)**
- **For automotive applications requiring specific change control (i.e. parts qualified to AEC-Q100/101/104/200, PPAP capable, and manufactured in IATF 16949 certified facilities), please [contact us](mailto:contact@diodes.com) or your local Diodes representative. <https://www.diodes.com/quality/product-definitions/>**

Notes: 1. No purposely added lead. Fully EU Directive 2002/95/EC (RoHS), 2011/65/EU (RoHS 2) & 2015/863/EU (RoHS 3) compliant.
2. See <https://www.diodes.com/quality/lead-free/> for more information about Diodes Incorporated's definitions of Halogen- and Antimony-free, "Green" and Lead-free.
3. Halogen- and Antimony-free "Green" products are defined as those which contain <900ppm bromine, <900ppm chlorine (<1500ppm total Br + Cl) and <1000ppm antimony compounds.

Pin Assignments

U-QFN3030-16 (Type B)

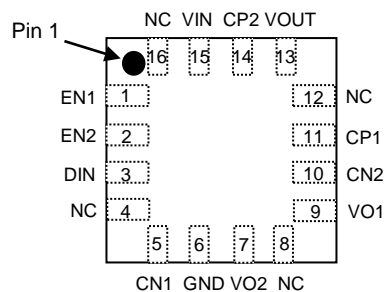

Top View

**U-QFN3030-12 (Type A)/W-QFN2020-12 (Type US)/
U-QFN2020-12 (Type UX)**

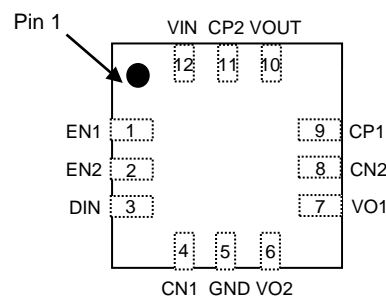

Top View

Applications

- Health care systems
- Alarm clocks
- Security devices
- Home appliances

Typical Applications Circuit

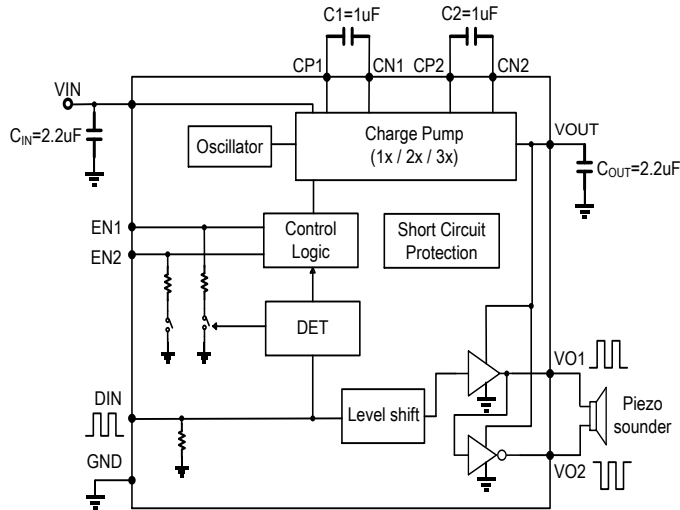

Pin Descriptions

Pin Number		Pin Name	I/O/P	Function
U-QFN3030-16 (Type B)	U-QFN3030-12 (Type A) W-QFN2020-12 (Type US) U-QFN2020-12 (Type UX)			
1	1	EN1	I	Charge Pump Mode Select 1
2	2	EN2	I	Charge Pump Mode Select 2
3	3	DIN	I	Signal Input
4	—	NC	—	No Connection
5	4	CN1	I	Capacitor 1 Negative Terminal
6	5	GND	P	Ground
7	6	VO2	O	Positive Output
8	—	NC	—	No Connection
9	7	VO1	O	Negative Output
10	8	CN2	I	Capacitor 2 Negative Terminal
11	9	CP1	I	Capacitor 1 Positive Terminal
12	—	NC	—	No Connection
13	10	VOUT	O	Boost Output
14	11	CP2	I	Capacitor 2 Positive Terminal
15	12	VIN	P	Power Supply
16	—	NC	—	No Connection

Absolute Maximum Ratings (Note 4) (@ $T_A = +25^\circ\text{C}$, unless otherwise specified.)

Symbol	Characteristics	Value	Unit
V_{IN}	Supply Voltage	-0.3 to 6.0	V
V_{OUT}	Output Voltage	15	V
V_{EN1}, V_{EN2}	EN1, EN2 Voltage	GND -0.3 to $V_{IN} + 0.3$	V
T_A	Operating Free-Air Temperature Range	-40 to +85	$^\circ\text{C}$
T_J	Operating Junction Temperature Range	-40 to +150	$^\circ\text{C}$
T_{STG}	Storage Temperature Range	-65 to +150	$^\circ\text{C}$

Note: 4. Stresses greater than those listed under *Absolute Maximum Ratings* can cause permanent damage to the device. These are stress ratings only, and functional operation of the device at these or any other conditions beyond those indicated under *Recommended Operating Conditions* is not implied. Exposure to *Absolute Maximum Ratings* for extended periods can affect device reliability.

Recommended Operating Conditions (@ $T_A = +25^\circ\text{C}$, unless otherwise specified.)

Symbol	Characteristics		Min	Max	Unit
V_{IN}	Supply Voltage	—	1.5	5.5	V
V_{IH}	High-Level Input Voltage	EN1, EN2	0.5 x V_{IN} to V_{IN}		V
V_{IL}	Low-Level Input Voltage	EN1, EN2	-0.3	0.4	V
T_A	Operating Free-Air Temperature		-40	+85	$^\circ\text{C}$

Thermal Information

Symbol	Parameter	Package	Max	Unit
θ_{JA}	Thermal Resistance (Junction to Ambient)	U-QFN3030-16 (Type B)	35	$^\circ\text{C/W}$
		U-QFN3030-12 (Type A)	35	
		U-QFN2020-12 (Type UX)	68	
		W-QFN2020-12 (Type US)	68	
θ_{JC}	Thermal Resistance (Junction to Case)	U-QFN3030-16 (Type B)	14	$^\circ\text{C/W}$
		U-QFN3030-12 (Type A)	14	
		U-QFN2020-12 (Type UX)	25	
		W-QFN2020-12 (Type US)	25	

Electrical Characteristics (@ $T_A = +25^\circ\text{C}$, $V_{IN} = 3.0\text{V}$, $C_{PIEZO} = 47\text{nF}$, $f_{DIN} = 3.2\text{kHz}$, unless otherwise specified.)

Symbol	Parameter	Conditions	Min	Typ	Max	Unit
V_{OUT}	Output Voltage Range	(Note 5)	1.5	—	13.5	V
V_{OUT1}	Output Voltage	1x Mode	2.8	—	3	V
V_{OUT2}		2x Mode	5.2	—	6	V
V_{OUT3}		3x Mode (Note 6)	7.2	—	9	V
V_{OUT4}		3x Mode ($V_{IN} = 2.7\text{V}$)	6.8	7	8.0	V
I_{DD11}	Operating Current 1	1x Mode, $C_{PIEZO} = \text{No Load}$	—	43	—	μA
I_{DD12}		2x Mode, $C_{PIEZO} = \text{No Load}$	—	118	—	μA
I_{DD13}		3x Mode, $C_{PIEZO} = \text{No Load}$	—	220	—	μA
I_{DD21}	Operating Current 2	1x Mode, Single-Ended Application	—	0.48	—	mA
I_{DD22}		2x Mode, Single-Ended Application	—	1.9	—	mA
I_{DD23}		3x Mode, Single-Ended Application	—	4.3	—	mA
I_{DD31}	Operating Current 3	1x Mode, Differential Application	—	1.7	—	mA
I_{DD32}		2x Mode, Differential Application	—	6.4	—	mA
I_{DD33}		3x Mode, Differential Application	—	14.2	—	mA
I_{SD}	Shutdown Current	$DIN = 0\text{V}$	—	0.008	1	μA
f_{IN}	Input Frequency	Rectangular Pulse	—	3.2	—	kHz
f_{OSC}	Oscillating Frequency	—	70	100	130	kHz
t_{ON1}	V_{OUT} Start Delay Time	1x Mode, from DIN Signal High to 90% V_{OUT} Steady State	—	470	—	μs
t_{ON2}		2x Mode, from DIN Signal High to 90% V_{OUT} Steady State	—	1.76	—	ms
t_{ON3}		3x Mode, from DIN Signal High to 90% V_{OUT} Steady State	—	1.91	—	ms
t_{OFF}	Shutdown Delay Time	$DIN = H \rightarrow L$	—	42	—	ms
I_{SC}	Output Short-Circuit Current	—	—	49	—	mA
V_{IH}	Control Terminal Voltage H	EN1, EN2, DIN Pins	$0.5 \times V_{IN}$	—	V_{IN}	V
V_{IL}	Control Terminal Voltage L	EN1, EN2, DIN Pins	0	—	0.4	V
I_{IH1}	Control Terminal Current 1	$DIN = 3\text{V}$	—	—	5	μA
I_{IH2}	Control Terminal Current 2	$V_{EN1}, V_{EN2} = 3\text{V}, DIN = 3\text{V}$	—	—	5	μA
I_{IH3}	Control Terminal Current 3	$V_{EN1}, V_{EN2} = 3\text{V}, DIN = 0\text{V}$	—	—	1	μA

- Notes:
5. It is possible to drive V_{OUT} , $VO1$ and $VO2$ to $3x V_{DD}$. A supply voltage of 4.5V or more should not be used in 3x mode as this will exceed the maximum output voltage rating.
 6. When designed under 3x mode, it should be carefully noted that the V_{OUT} absolute maximum value should not exceed 13.5V.

Application Information

Charge Pump Mode Setting

The Charge Pump Mode (CPM) pins EN1 and EN2 are used to set the charge pump into mode 1x V_{DD}, 2x V_{DD}, 3x V_{DD} or they can be used to put the PAM8904E into a forced low current shutdown mode.

DIN	EN1	EN2	MODE
0	—	—	Shutdown Mode
1	0	0	Shutdown Mode
1	0	1	1x Mode
1	1	0	2x Mode
1	1	1	3x Mode

V _{DD} Range	Mode
1.5V to 4.5V	1x, 2x and 3x
1.5V to 5.5V	1x, 2x

Timing Chart and Device Operation

When one or both of the EN pins are pulled high, the device enters normal operation mode. Refer to the above table for the mode selection. Once the PAM8904E senses a valid signal on the DIN pin, the charge pump will start and provide the desired voltage on the VOUT pin and the output drive VO1 and VO2 start to function after time t_{ON} which is typically between 470μs and 2s depending on the mode chosen. Once the input signal on DIN is removed, the PAM8904E senses this and waits typically 42ms to ensure the signal has been removed. If there is no further valid signal within the time period t_{OFF}, the PAM8904E enters into a low current standby mode.

Timing Chart

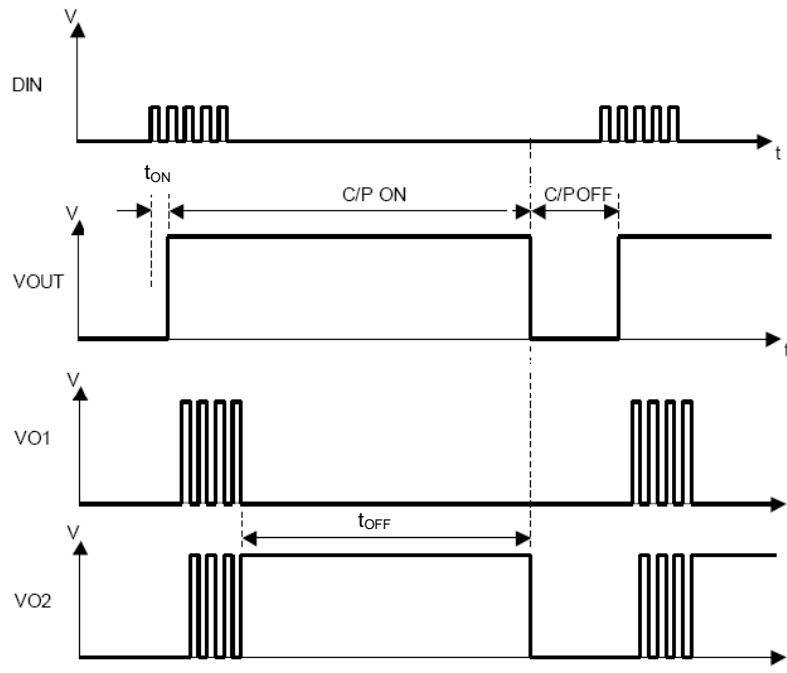

Application Information (continued)

Output Configuration

The PAM8904E is able to be configured either in a differential or a single ended configuration.

Short-Circuit Protection

The PAM8904E has short-circuit protection circuitry on the outputs to prevent damage. Once a short circuit is detected on the outputs, the chip will limit the total current to protect the output device. This is not a latched fault; once the short is removed, the normal operation is restored.

Thermal Protection

If the junction temperature of the PAM8904E exceeds +150°C, the device will enter overtemperature shutdown. The outputs and the charge pump will be switched off. Once the junction temperature cools down to its normal operating condition, the IC will restart automatically.

Ordering Information

PAM8904E XXXX

Package and Packing

- JER : U-QFN3030-16 (Type B) with T/R
- JPR : U-QFN3030-12 (Type A) with T/R
- GPR : W-QFN2020-12 (Type US) with T/R
- GPR-T : U-QFN2020-12 (Type UX) with T/R

Part Number	Package	Status	Packing	
			Qty.	Carrier
PAM8904EJER	U-QFN3030-16 (Type B)	NRND* (CONTACT US)	3,000	Tape & Reel
PAM8904EJPR	U-QFN3030-12 (Type A)	NRND* (CONTACT US)	3,000	Tape & Reel
PAM8904EGPR	W-QFN2020-12 (Type US)	Active	3,000	Tape & Reel
PAM8904EGPR-T	U-QFN2020-12 (Type UX)	Active	3,000	Tape & Reel

*NRND: Not Recommended for New Design.

Marking Information

U-QFN3030-16 (Type B)/U-QFN3030-12 (Type A)

(Top View)

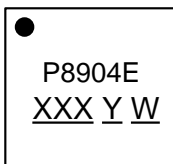

- P8904E : Identification Code
- XXX : Internal Code
- Y : Year : 0 to 9 (ex: 3 = 2023)
- W : Week : A to Z : week 1 to 26;
a to z : week 27 to 52; z represents week 52 and 53

W-QFN2020-12 (Type US)/U-QFN2020-12 (Type UX)

(Top View)

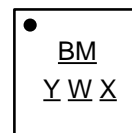

- BM : Identification Code
- Y : Year : 0 to 9 (ex: 3 = 2023)
- W : Week : A to Z : week 1 to 26;
a to z : week 27 to 52; z represents week 52 and 53
- X : Internal Code

Package Outline Dimensions

Please see <http://www.diodes.com/package-outlines.html> for the latest version.

(1) Package Type: U-QFN3030-16 (Type B)

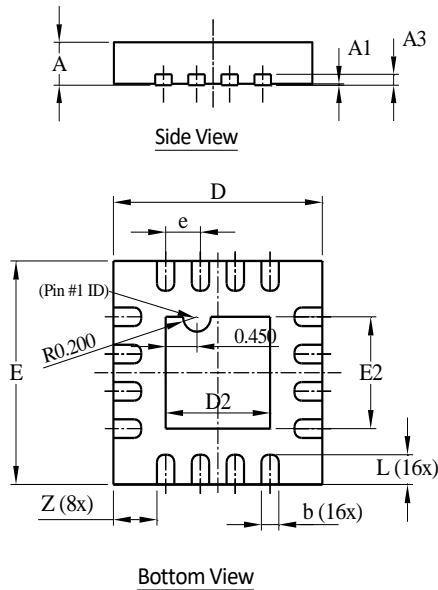

U-QFN3030-16 (Type B)			
Dim	Min	Max	Typ
A	0.55	0.65	0.60
A1	0	0.05	0.02
A3	-	-	0.15
b	0.18	0.28	0.23
D	2.95	3.05	3.00
D2	1.40	1.60	1.50
E	2.95	3.05	3.00
E2	1.40	1.60	1.50
e	-	-	0.50
L	0.35	0.45	0.40
Z	-	-	0.625
All Dimensions in mm			

(2) Package Type: U-QFN3030-12 (Type A)

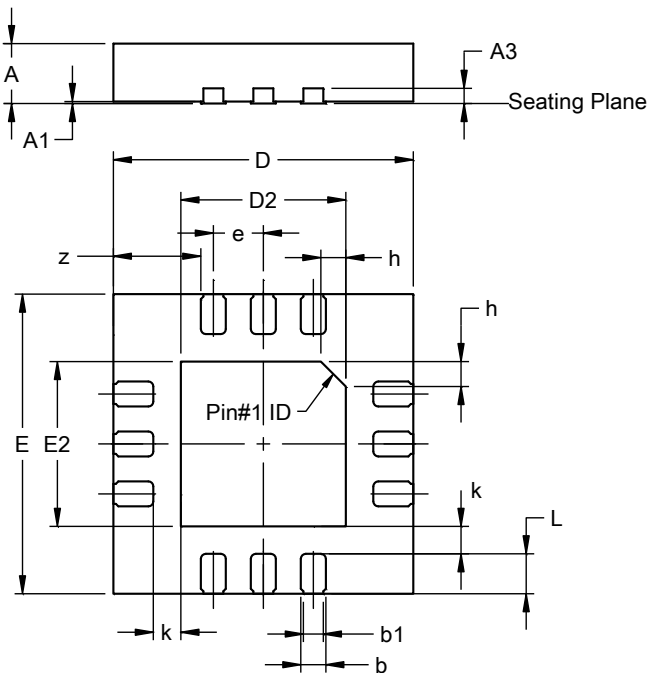

U-QFN3030-12 (Type A)			
Dim	Min	Max	Typ
A	0.55	0.65	0.60
A1	0.00	0.05	0.02
A3	--	--	0.152
b	0.20	0.35	0.25
b1	0.15	0.25	0.20
D	2.95	3.05	3.00
D2	1.55	1.75	1.65
E	2.95	3.05	3.00
E2	1.55	1.75	1.65
e	--	--	0.50
h	--	--	0.25
L	0.35	0.45	0.40
k	--	--	0.275
z	--	--	0.875
All Dimensions in mm			

Package Outline Dimensions (continued)

Please see <http://www.diodes.com/package-outlines.html> for the latest version.

(3) Package Type: W-QFN2020-12 (Type US)

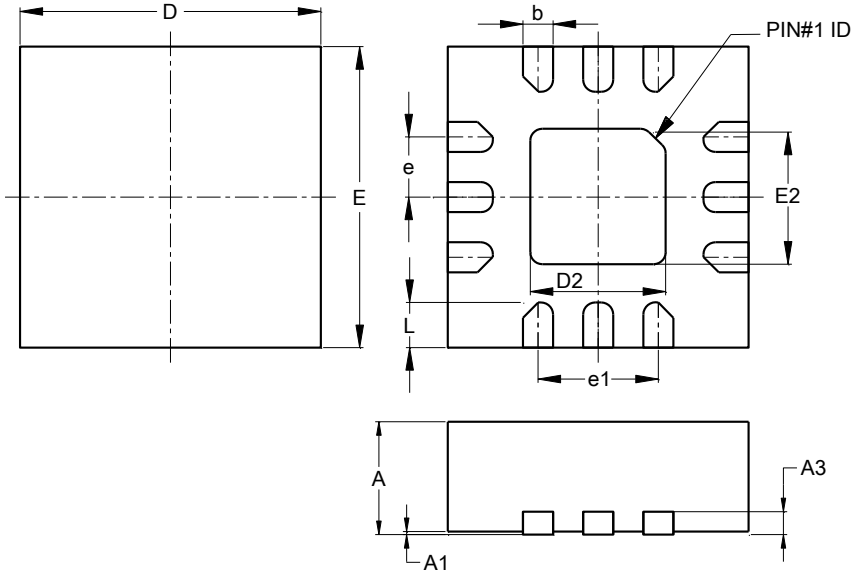

W-QFN2020-12 (Type US)			
Dim	Min	Max	Typ
A	0.700	0.800	0.750
A1	0.00	0.050	--
A3	0.203REF		
b	0.150	0.250	0.200
D	1.950	2.050	2.000
D2	0.850	0.950	0.900
E	1.950	2.050	2.000
E2	0.850	0.950	0.900
e	0.400 BSC		
e1	0.800 REF		
L	0.250	0.350	0.300
All Dimensions in mm			

(4) Package Type: U-QFN2020-12 (Type UX)

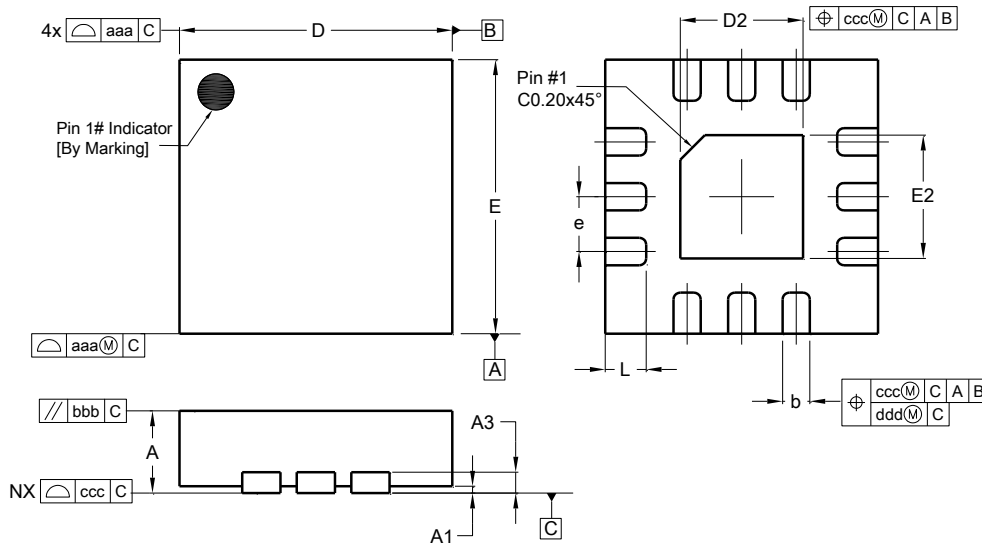

U-QFN2020-12 (Type UX)			
Dim	Min	Max	Typ
A	0.550	0.650	0.600
A1	—	0.05	—
A3	0.127 REF		
b	0.180	0.280	0.230
D	1.950	2.050	2.00
D2	0.850	0.950	0.900
E	1.950	2.050	2.00
E2	0.850	0.950	0.900
e	0.400 BSC		
L	0.250	0.350	0.300
aaa	0.10		
bbb	0.10		
ccc	0.05		
ddd	0.05		
All Dimensions in mm			

Suggested Pad Layout

Please see <http://www.diodes.com/package-outlines.html> for the latest version.

(1) Package Type: U-QFN3030-16 (Type B)

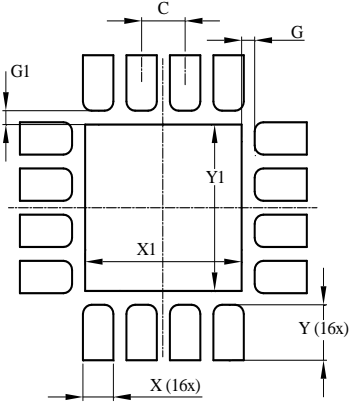

Dimensions	Value (in mm)
C	0.500
G	0.150
G1	0.150
X	0.350
X1	1.800
Y	0.600
Y1	1.800

(2) Package Type: U-QFN3030-12 (Type A)

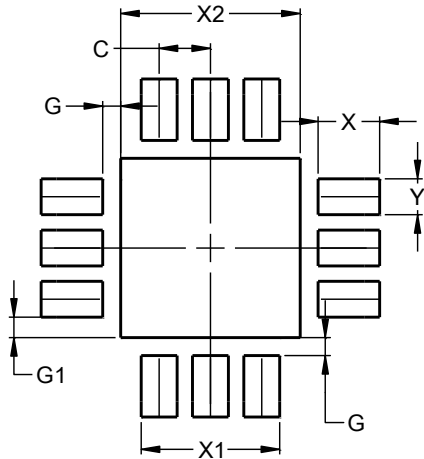

Dimensions	Value (in mm)
C	0.500
G	0.175
G1	0.200
X	0.600
X1	1.350
X2	1.750
Y	0.350
Y1	1.750

(3) Package Type: W-QFN2020-12 (Type US)

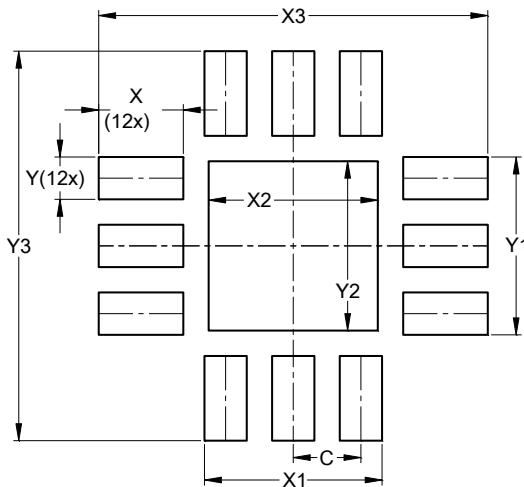

Dimensions	Value (in mm)
C	0.400
X	0.500
X1	1.050
X2	1.000
X3	2.300
Y	0.250
Y1	1.050
Y2	1.000
Y3	2.300

Suggested Pad Layout (continued)

Please see <http://www.diodes.com/package-outlines.html> for the latest version.

(4) Package Type: U-QFN2020-12 (Type UX)

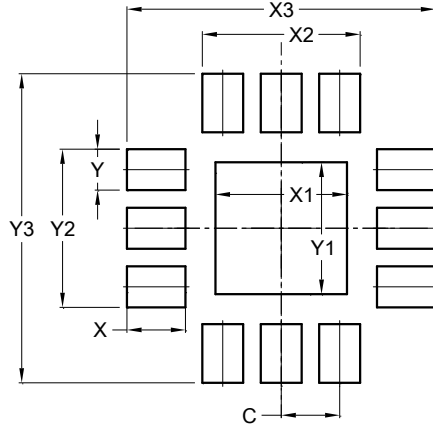

Dimensions	Value (in mm)
C	0.400
X	0.400
X1	0.900
X2	1.080
X3	2.110
Y	0.280
Y1	0.900
Y2	1.080
Y3	2.110

Mechanical Data

U-QFN3030-16 (Type B)/U-QFN3030-12 (Type A)

- Moisture Sensitivity: Level 1 per J-STD-020
- Terminals: Finish—NiPdAu Leads, Solderable per MIL-STD-202, Method 208 (e4)
- Weight: 0.016 grams (Approximate)

W-QFN2020-12 (Type US)

- Moisture Sensitivity: Level 1 per J-STD-020
- Terminals: Finish—Matte Tin Plated Leads, Solderable per MIL-STD-202, Method 208 (e3)
- Weight: 0.009 grams (Approximate)

U-QFN2020-12 (Type UX)

- Moisture Sensitivity: Level 1 per J-STD-020
- Terminals: Finish—NiPdAu Leads, Solderable per MIL-STD-202, Method 208 (e4)
- Weight: 0.0068 grams (Approximate)

IMPORTANT NOTICE



1. DIODES INCORPORATED (Diodes) AND ITS SUBSIDIARIES MAKE NO WARRANTY OF ANY KIND, EXPRESS OR IMPLIED, WITH REGARDS TO ANY INFORMATION CONTAINED IN THIS DOCUMENT, INCLUDING, BUT NOT LIMITED TO, THE IMPLIED WARRANTIES OF MERCHANTABILITY, FITNESS FOR A PARTICULAR PURPOSE OR NON-INFRINGEMENT OF THIRD PARTY INTELLECTUAL PROPERTY RIGHTS (AND THEIR EQUIVALENTS UNDER THE LAWS OF ANY JURISDICTION).
2. The Information contained herein is for informational purpose only and is provided only to illustrate the operation of Diodes' products described herein and application examples. Diodes does not assume any liability arising out of the application or use of this document or any product described herein. This document is intended for skilled and technically trained engineering customers and users who design with Diodes' products. Diodes' products may be used to facilitate safety-related applications; however, in all instances customers and users are responsible for (a) selecting the appropriate Diodes products for their applications, (b) evaluating the suitability of Diodes' products for their intended applications, (c) ensuring their applications, which incorporate Diodes' products, comply the applicable legal and regulatory requirements as well as safety and functional-safety related standards, and (d) ensuring they design with appropriate safeguards (including testing, validation, quality control techniques, redundancy, malfunction prevention, and appropriate treatment for aging degradation) to minimize the risks associated with their applications.
3. Diodes assumes no liability for any application-related information, support, assistance or feedback that may be provided by Diodes from time to time. Any customer or user of this document or products described herein will assume all risks and liabilities associated with such use, and will hold Diodes and all companies whose products are represented herein or on Diodes' websites, harmless against all damages and liabilities.
4. Products described herein may be covered by one or more United States, international or foreign patents and pending patent applications. Product names and markings noted herein may also be covered by one or more United States, international or foreign trademarks and trademark applications. Diodes does not convey any license under any of its intellectual property rights or the rights of any third parties (including third parties whose products and services may be described in this document or on Diodes' website) under this document.
5. Diodes' products are provided subject to Diodes' Standard Terms and Conditions of Sale (<https://www.diodes.com/about/company/terms-and-conditions/terms-and-conditions-of-sales/>) or other applicable terms. This document does not alter or expand the applicable warranties provided by Diodes. Diodes does not warrant or accept any liability whatsoever in respect of any products purchased through unauthorized sales channel.
6. Diodes' products and technology may not be used for or incorporated into any products or systems whose manufacture, use or sale is prohibited under any applicable laws and regulations. Should customers or users use Diodes' products in contravention of any applicable laws or regulations, or for any unintended or unauthorized application, customers and users will (a) be solely responsible for any damages, losses or penalties arising in connection therewith or as a result thereof, and (b) indemnify and hold Diodes and its representatives and agents harmless against any and all claims, damages, expenses, and attorney fees arising out of, directly or indirectly, any claim relating to any noncompliance with the applicable laws and regulations, as well as any unintended or unauthorized application.
7. While efforts have been made to ensure the information contained in this document is accurate, complete and current, it may contain technical inaccuracies, omissions and typographical errors. Diodes does not warrant that information contained in this document is error-free and Diodes is under no obligation to update or otherwise correct this information. Notwithstanding the foregoing, Diodes reserves the right to make modifications, enhancements, improvements, corrections or other changes without further notice to this document and any product described herein. This document is written in English but may be translated into multiple languages for reference. Only the English version of this document is the final and determinative format released by Diodes.
8. Any unauthorized copying, modification, distribution, transmission, display or other use of this document (or any portion hereof) is prohibited. Diodes assumes no responsibility for any losses incurred by the customers or users or any third parties arising from any such unauthorized use.
9. This Notice may be periodically updated with the most recent version available at <https://www.diodes.com/about/company/terms-and-conditions/important-notice>

The Diodes logo is a registered trademark of Diodes Incorporated in the United States and other countries.
All other trademarks are the property of their respective owners.
© 2023 Diodes Incorporated. All Rights Reserved.

www.diodes.com

Looking for pricing, stock, or lifecycle information?

Click below to explore more details on WIN SOURCE:

-  [View PAM8904EGPR on WIN SOURCE](#)
-  [Diodes Incorporated Information](#)

Optimize Your Supply Chain with WIN SOURCE Solutions

-  Global Sourcing Solution
-  Obsolete Management
-  Cost Control Management
-  Shortage Management
-  Alternative Solution
-  Excess Inventory Management