



**THE DATASHEET OF
ISL8203MEVAL2Z**



ISL8203MEVAL2Z

Evaluation Board

AN1941
Rev 1.00
August 29, 2014

The ISL8203M is a complete, dual step-down power module with integrated PWM controller, synchronous switching MOSFETs, inductors, and passives. The ISL8203M is rated for dual 3A output current or 6A current sharing operation with an input range of 2.85V to 6V. The two channels are 180° out-of-phase for input RMS current and EMI reduction.

The simplicity of the ISL8203M is its off the shelf, unassisted implementation. It is easy to apply this complete step-down power module to any low voltage low power application.

The ISL8203MEVAL2Z evaluation board is designed to demonstrate the performance of the ISL8203M. The board is by default set up to demonstrate two 3A outputs independently, and can also be easily set up for current sharing 6A by changing placeholder resistors.

Related Resources

[ISL8203M](#) datasheet

Ordering Information

PART NUMBER	DESCRIPTION
ISL8203MEVAL2Z	ISL8203M Dual 3A/Single 6A Power Module Evaluation Board

Key Features

- V_{IN} range 2.85V to 6V
- V_{OUT} adjustable 0.8V to 5V
- Peak current limiting and hiccup mode short circuit protection
- Over-temperature protection
- Internal digital soft-start
- External synchronization up to 4MHz
- Flexibility to operate in dual output mode or parallel single output mode with simple resistor changes.
- Mechanical switch for enable and power-good LED indicator
- Connectors, test points, and jumpers for easy probing

Recommended Equipment

- 0V to 6V power supply with at least 5A source current capability
- Electronic load capable of sinking current up to 6A
- Digital multimeters (DMMs)
- 100MHz quad-trace oscilloscope

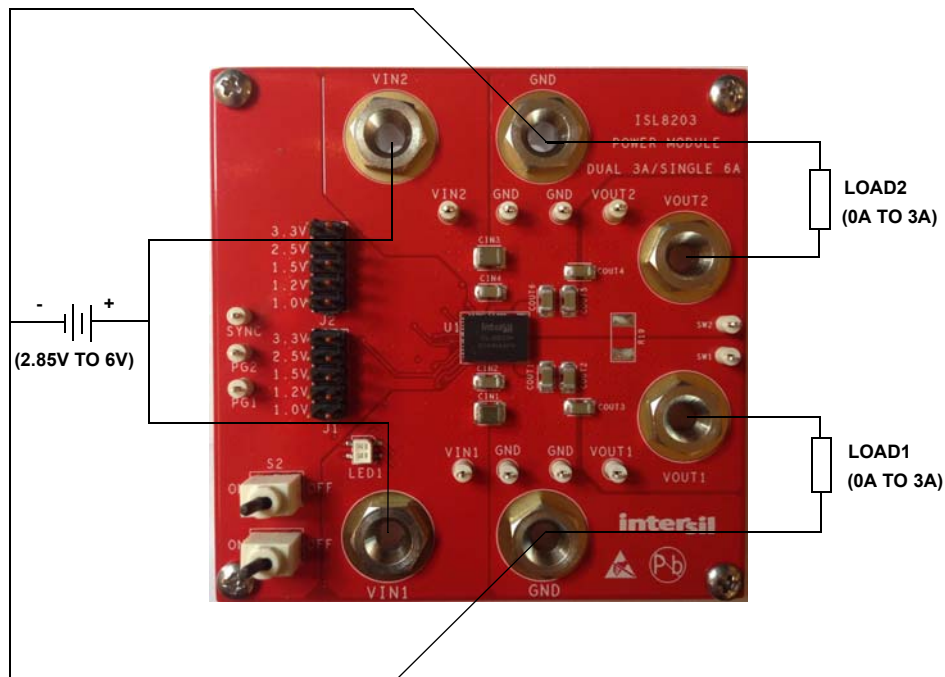

FIGURE 1. ISL8203MEVAL2Z BOARD PHOTO

Functional Description

The ISL8203M's two 3A outputs may be used independently or combined to deliver a single 6A output. Each of the two channels employs the current mode pulse width modulation scheme for fast transient response and pulse-by-pulse current limiting. The two channels each operate at a fixed 1MHz switching frequency, and are 180° out-of-phase, which reduces the input and output noise. The ISL8203M offers internal digital soft-start, external synchronization, overcurrent protection, and over-temperature protection. For further information, please refer to the [ISL8203M datasheet](#).

Quick Start

Dual Output Mode

1. Make sure the placeholder resistors are set for dual output mode according to [Table 1](#) (The ISL8203MEVAL2Z evaluation board is by default set up in dual output mode).
2. Set the ENABLE switches S1 and S2 to "OFF" positions.
3. Select the output voltage for channel 1 by making a selection on jumper J1. Similarly, select the output voltage for channel 2 by making a selection on jumper J2.
4. Connect the positive of a power supply to VIN1 and VIN2 connectors, and the negative of the power supply to one or both of the GND connectors. Make sure the power supply is not enabled when making connections.
5. Turn the power supply on.
6. Turn ENABLE switch S1 to "ON" position to enable channel 1 and switch S2 to "on" position to enable channel 2. Each ENABLE switch can control channel 1 and channel 2 independently.
7. The power-good LED should glow in green if both channel 1 and channel 2 are operating properly. If either one channel is disabled or not operating properly, the LED will glow in red.
8. Measure the channel 1 (or channel 2) output voltage at test points VOUT1 (or VOUT2) test point and adjacent GND test point.

Parallel Single Output Mode

1. Set the placeholder resistors for parallel single output mode according to [Table 1](#).
2. Set the ENABLE switches S1 and S2 to "OFF" positions.
3. Select the output voltage using either one of the jumpers J1 and J2, but do not use both J1 and J2 at the same time.
4. Connect the positive of a power supply to VIN1 and VIN2 connectors, and the negative of the power supply to one or both of the GND connectors. Make sure the power supply is not enabled when making connections.
5. Turn the power supply on.
6. Turn both ENABLE switches S1 and S2 to "on" positions, in any order. Both ENABLE switches need to be in the "on" position in order to enable the output.
7. The power-good LED should glow in green if the output is operating properly. If module is disabled or not operating properly, the LED will glow in red.

8. Measure the output voltage at test points VOUT1 or VOUT2 and GND test point.

Programming the Output Voltage

The ISL8203MEVAL2Z evaluation board has several preset output voltages, 1.0V, 1.2V, 1.5V, 2.5V, and 3.3V, which can be selected in J1 and J2 jumper. To program for other output voltages in the range from 0.8V to 5V, the user can use a feedback resistor divider based on [Equation 1](#).

$$V_{OUT} = \left(1 + \frac{R_{FB-TOP}}{R_{FB-BOTTOM}} \right) \cdot 0.8V \quad (EQ. 1)$$

The top feedback resistor R_{FB-TOP} is typically 100kΩ. In the ISL8203MEVAL2Z evaluation board, the top feedback resistor is R_{12} (for channel 1) and R_{11} (for channel 2).

Setting Parallel Single Output Mode

The ISL8203MEVAL2Z evaluation board is by default set up in dual output mode with two independent outputs, but it can also be easily modified to parallel single output circuit by changing several placeholder resistors. [Table 1](#) shows the placeholder sets to program the default dual output mode and the parallel single output mode.

TABLE 1. PLACEHOLDER SETS TO PROGRAM DUAL OUTPUT MODE AND PARALLEL SINGLE OUTPUT MODE

PLACEHOLDER	DUAL OUTPUT MODE	PARALLEL SINGLE OUTPUT MODE
R ₁₃	Open	0Ω
R ₂₄	0Ω	Open
R ₂₅	0Ω	Open
R ₂₈	Open	0Ω
R ₁₈ , R ₁₉	Open	0Ω (SMD, size 2010) or copper strips

External Synchronization

The frequency of operation can be synchronized up to 4MHz by an external signal applied to the SYNC pin. The switching frequency per channel is half of the external signal's frequency applied to the SYNC pin. The maximum external signal frequency is limited by the SW minimum on time (140ns MAX) requirement, which can be calculated as shown in [Equation 2](#).

$$\frac{1}{2} \cdot f_{SYNC-MAX} = f_{SW-MAX} = \frac{V_{OUT}}{V_{IN}} \cdot \frac{1}{140ns} \quad (EQ. 2)$$

where:

- $f_{SYNC-MAX}$ is the maximum external signal frequency
- f_{SW-MAX} is the maximum switching frequency per channel

Evaluation Board Information

The ISL8203MEVAL2Z evaluation board is a 3X3 in four-layer FR-4 board with 2oz. copper on the top and bottom layers and 1oz. copper on all internal layers. The board can be used as a dual 3A reference design. Refer to “Layout” on [page 6](#). The board is designed with mechanical switches for ENABLE, power-good LED indicators, several connectors, test points, and jumpers, which make testing the board easy.

Thermal Considerations and Current Derating

Board layout is very critical in order to make the module operate safely and deliver maximum allowable power. In order for the board to operate properly in the high ambient temperature environments and carry full load currents, the board layout needs to be carefully designed to maximize thermal performance. To achieve this, select enough trace width, copper weight, and proper connectors.

The ISL8203MEVAL2Z evaluation board is capable of full load current (dual channel 3A or single 6A) at room temperature with plenty of safety margin for junction temperature. However, if the board is to operate at elevated ambient temperatures, then the available output current may need to be derated. Refer to the derated current curves in the [ISL8203M](#) datasheet to determine the maximum output current the evaluation board can supply.

ISL8203MEVAL2Z Schematic

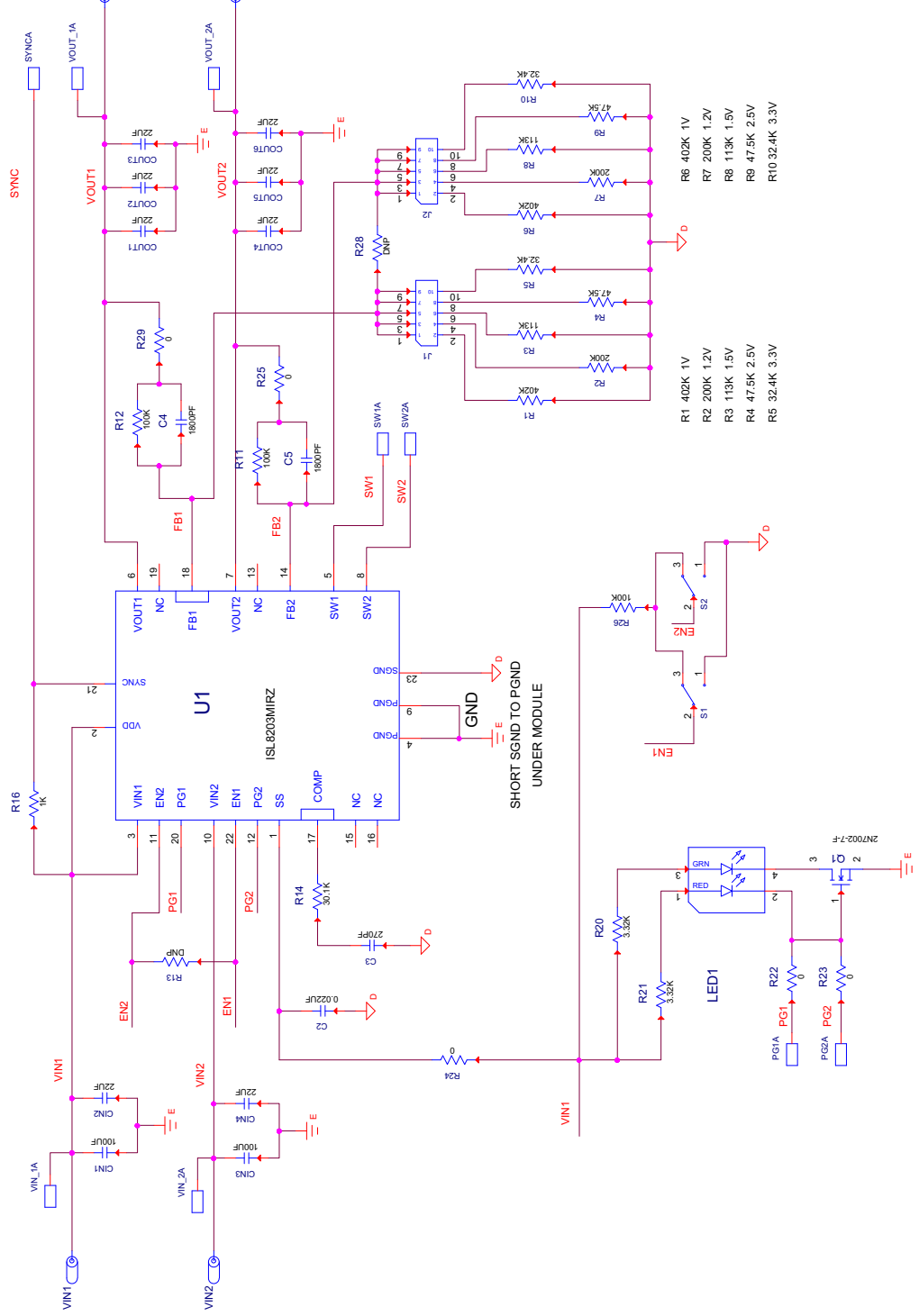

Bill of Materials

MANUFACTURER'S PART NUMBER	REFERENCE DESIGNATOR	QTY	MANUFACTURER	DESCRIPTION
C0603X7R500-223KNE	C2	1	VENKEL	CAP, SMD, 0603, 0.022 μ F, 50V, 10%, X7R, ROHS
C0603C271J5GACTU	C3	1	KEMET	CAP, SMD, 0603, 270pF, 50V, 5%, C0G, ROHS
GRM39X7R182K050AQ	C4, C5	2	MURATA	CAP, SMD, 0603, 1800pF, 50V, 10%, X7R, ROHS
EMK325ABJ107MM-T	CIN1, CIN3	2	TAIYO YUDEN	CAP, SMD, 1210, 100 μ F, 16V, 20%, X5R, ROHS
GRM31CR61C226KE15L	CIN2, CIN4, COUT1-COUT6	8	MURATA	CAP, SMD, 1206, 22 μ F, 16V, 10%, X5R, ROHS
108-0740-001	GND1, GND2, VIN1, VIN2, VOUT1, VOUT2	6	JOHNSON COMPONENTS	CONN-JACK, BANANA-SS-SDRLESS, VERTICAL, ROHS
67996-272HLF	J1, J2	2	BERG/FCI	CONN-HEADER, 2X5, BRKAWY-2X36, 2.54mm, ROHS
SSL-LXA3025IGC-TR	LED1	1	LUMEX	LED, SMD, 3x2.5mm, 4P, RED/GREEN, 12/20MCD, 2V
2N7002-7-F	Q1	1	DIODES, INC.	TRANSISTOR, N-CHANNEL, 3LD, SOT-23, 60V, 115mA, ROHS
ERJ-3EKF4023V	R1, R6	2	PANASONIC	RES, SMD, 0603, 402k, 1/16W, 1%, TF, ROHS
CRCW0603200KFKEA	R2, R7	2	VISHAY/DALE	RES, SMD, 0603, 200k, 1/10W, 1%, TF, ROHS
MCR03EZPFX1133	R3, R8	2	ROHM	RES, SMD, 0603, 113k, 1/10W, 1%, TF, ROHS
CR0603-10W-4752FT	R4, R9	2	VENKEL	RES, SMD, 0603, 47.5k, 1/10W, 1%, TF, ROHS
ERJ-3EKF3242V	R5, R10	2	PANASONIC	RES, SMD, 0603, 32.4k, 1/10W, 1%, TF, ROHS
CR0603-10W-1003FT	R11, R12, R26	3	VENKEL	RES, SMD, 0603, 100k, 1/10W, 1%, TF, ROHS
	R13, R28	0		RESISTOR, SMD, 0603, 0.1%, MF, DNP-PLACE HOLDER
CR0603-10W-3012FT	R14	1	VENKEL	RES, SMD, 0603, 30.1k, 1/10W, 1%, TF, ROHS
ERJ-3EKF1001V	R16	1	PANASONIC	RES, SMD, 0603, 1k, 1/10W, 1%, TF, ROHS
	R18, R19	0		RES, SMD, 2010, DNP, DNP, DNP, TF, ROHS
RC0603FR-073K32L	R20, R21	2	YAGEO	RES, SMD, 0603, 3.32k, 1/10W, 1%, TF, ROHS
CR0603-10W-000T	R22, R23, R24, R25, R27, R29	6	VENKEL	RES, SMD, 0603, 0 Ω , 1/10W, TF, ROHS
GT13MCBE	S1, S2	2	C&K COMPONENTS	SWITCH-TOGGLE, THRU-HOLE, 5PIN, SPDT, 3POS, ON-OFF-ON, ROHS
ISL8203MIRZ	U1		INTERSIL	IC-6A POWER SUPPLY MODULE, 23P, QFN, ROHS

Board Layout

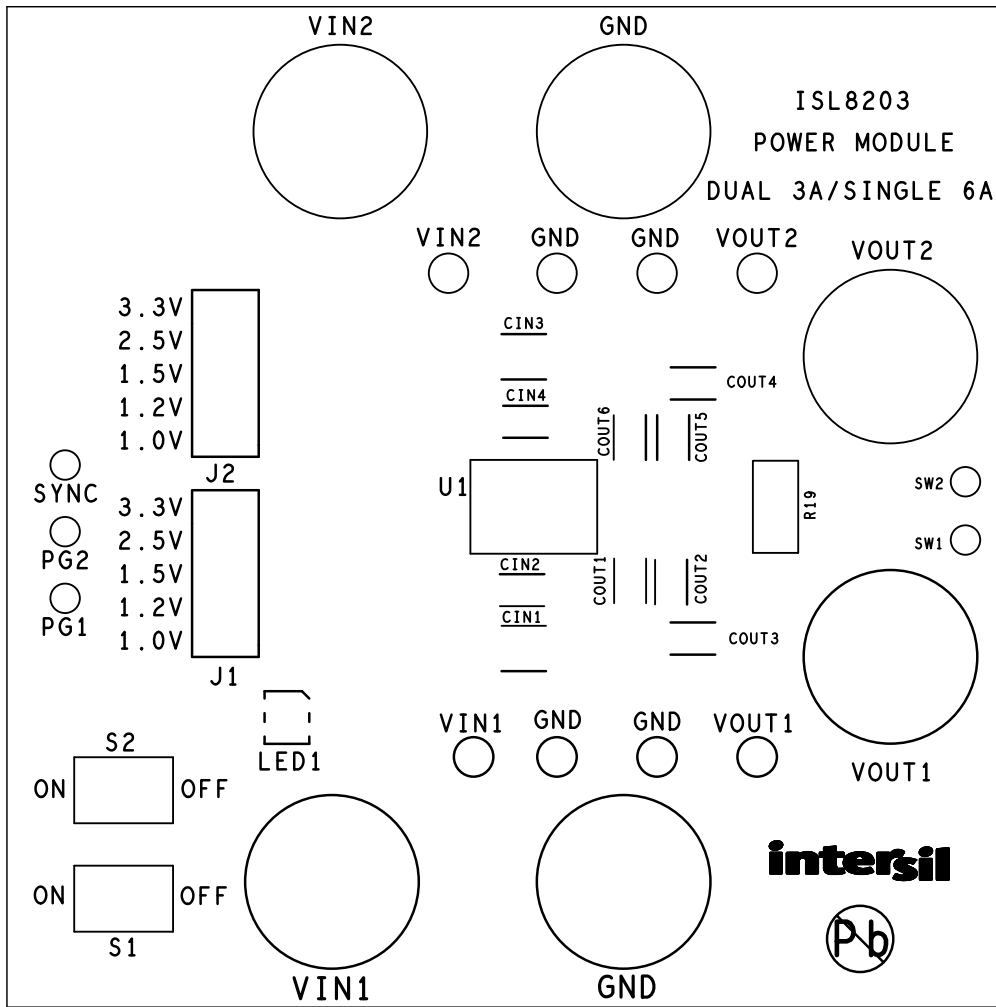

FIGURE 2. SILK SCREEN TOP LAYER

Board Layout

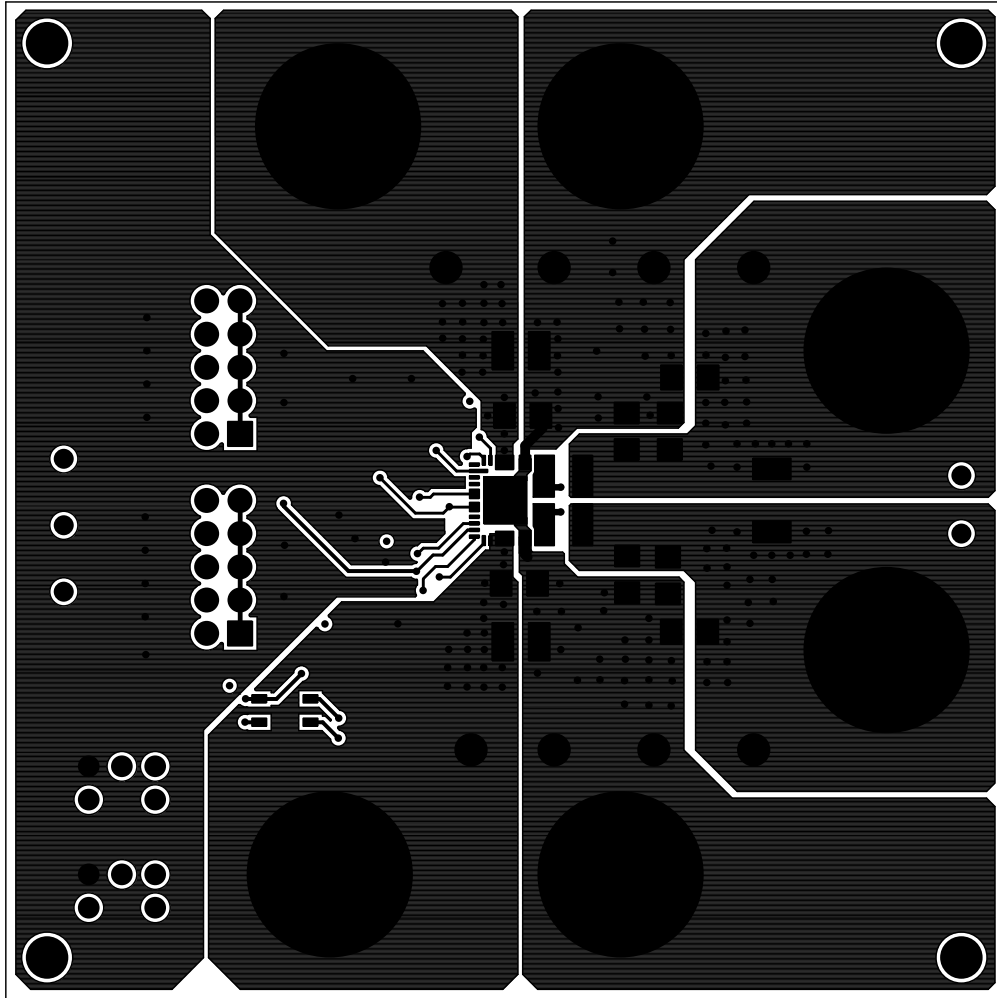

FIGURE 3. TOP LAYER

Board Layout

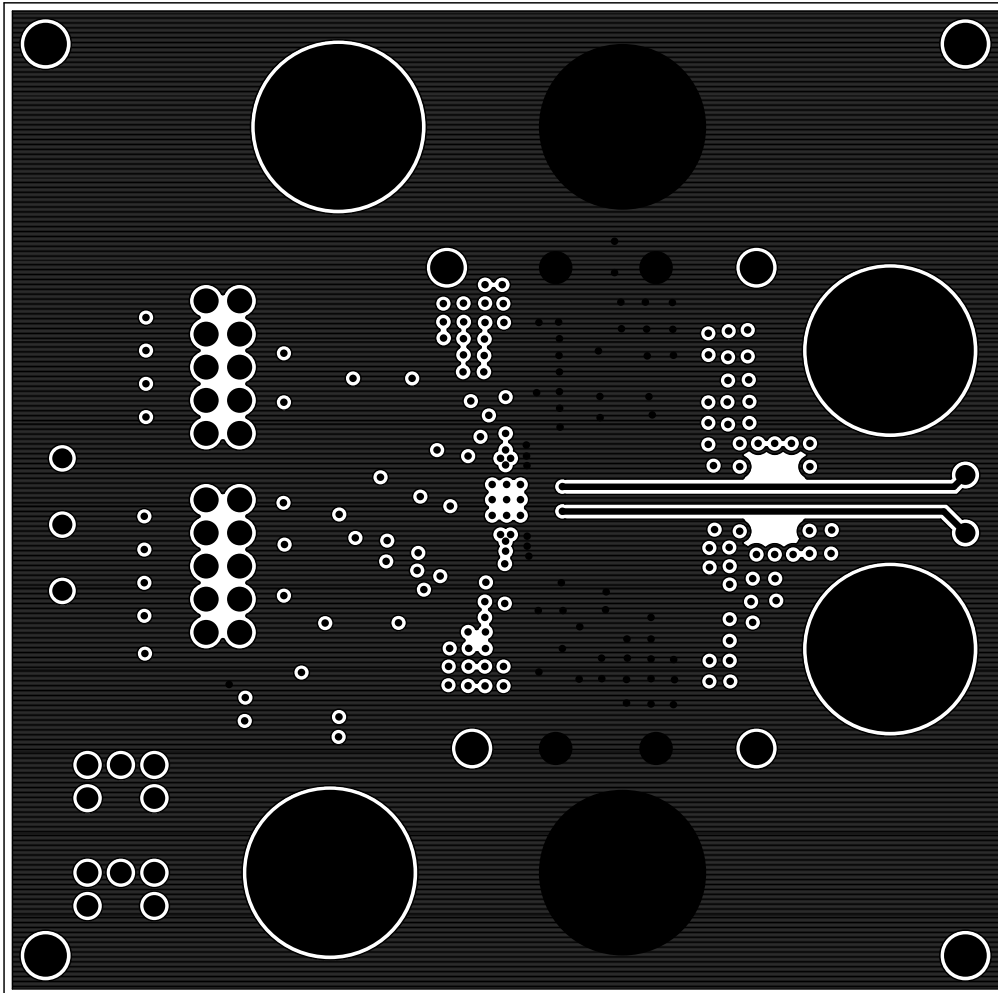

FIGURE 4. LAYER 2

Board Layout

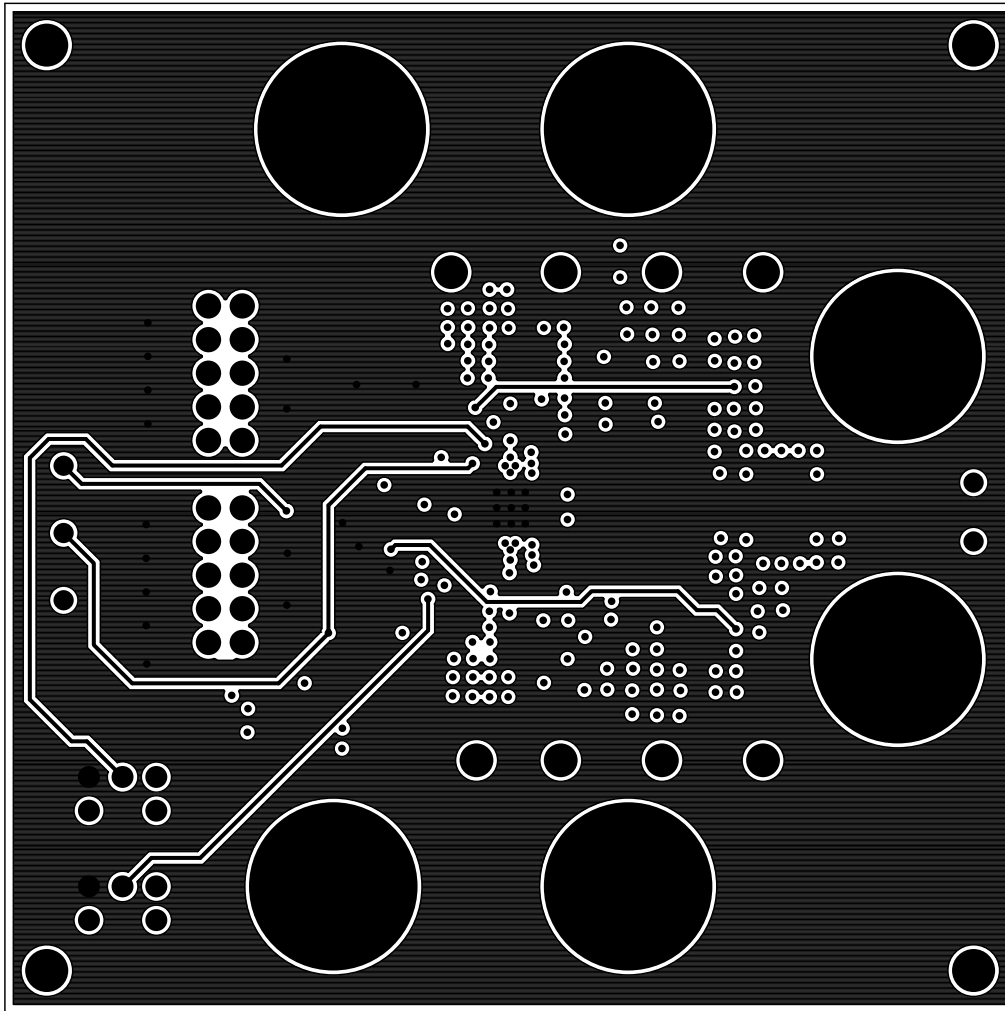

FIGURE 5. LAYER 3

Board Layout

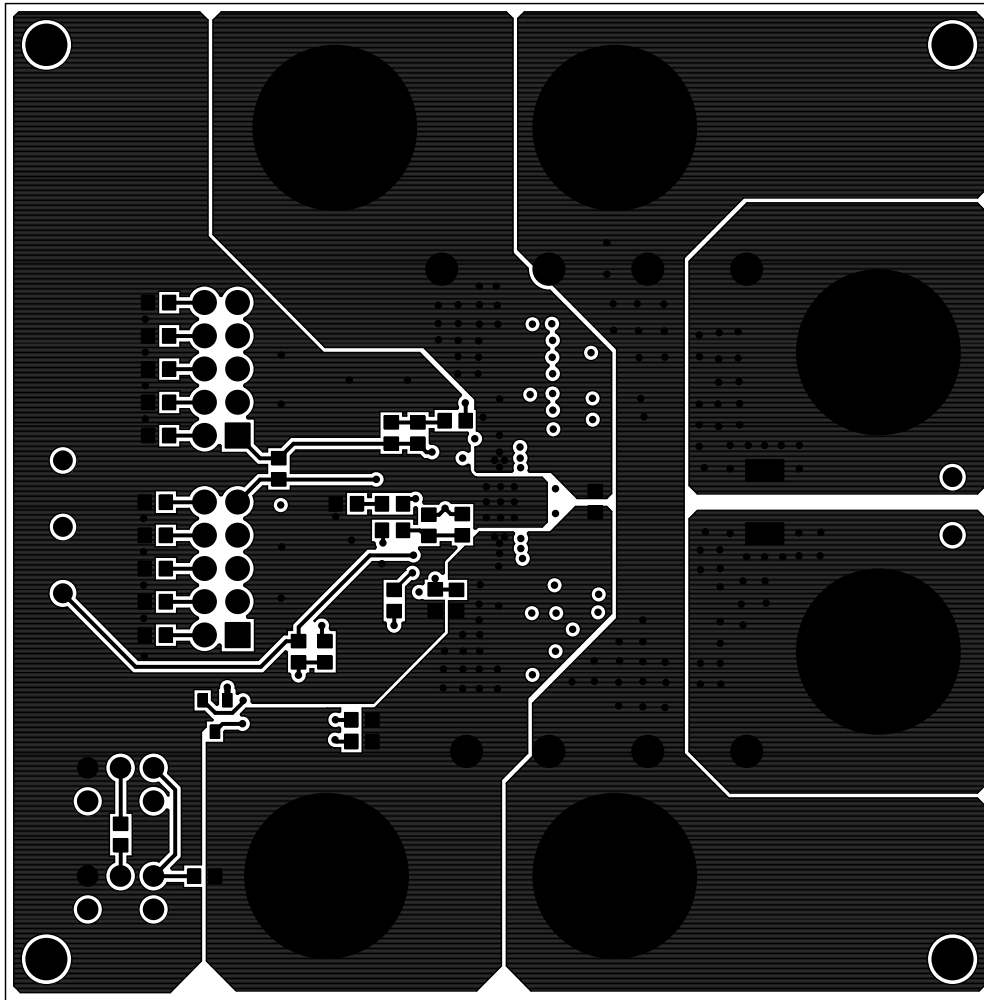

FIGURE 6. BOTTOM LAYER

Board Layout

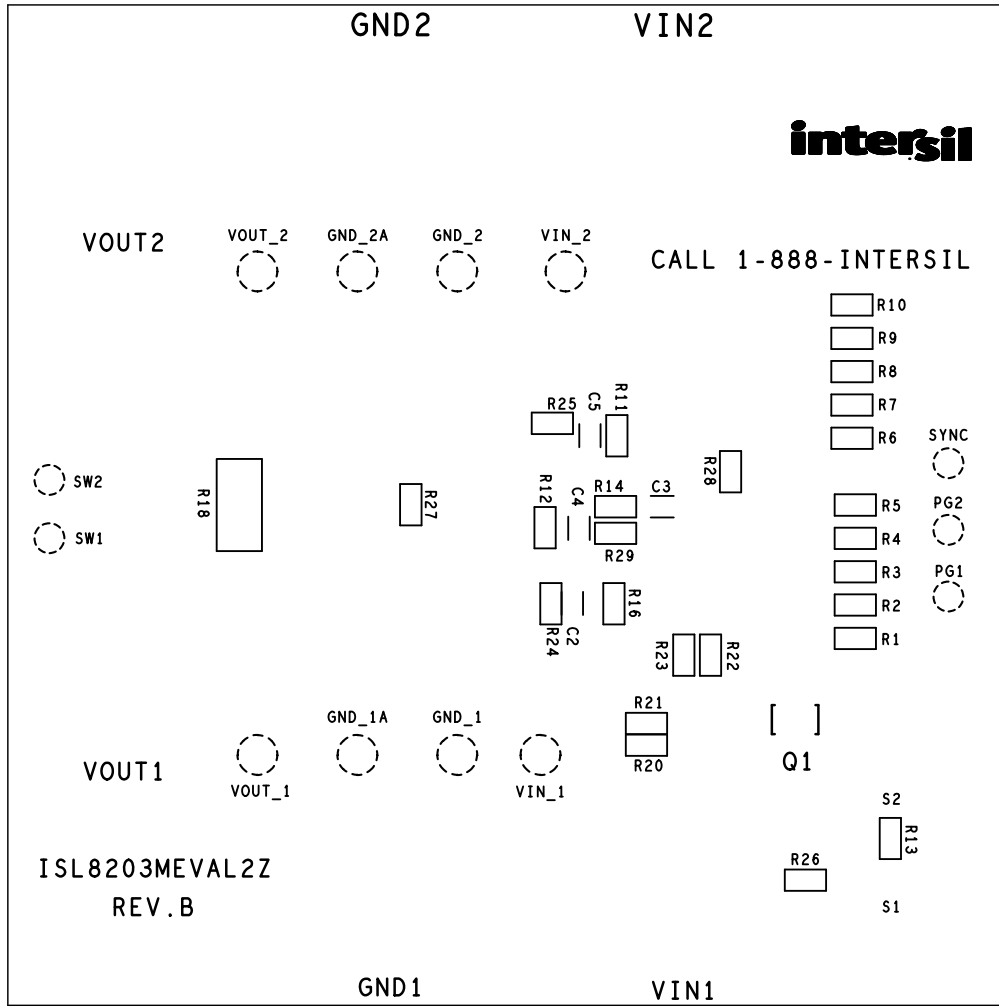

FIGURE 7. SILK SCREEN BOTTOM

ISL8203MEVAL2Z Performance Data

The following data was acquired using a ISL8203MEVAL2Z

evaluation board at +25°C ambient and free air OLFM.

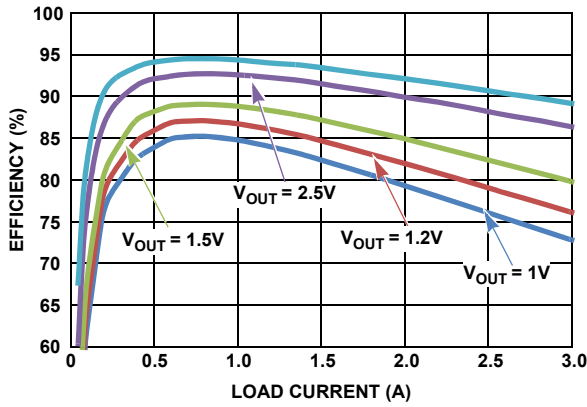

FIGURE 8. EFFICIENCY, SINGLE CHANNEL, $V_{IN} = 5V$

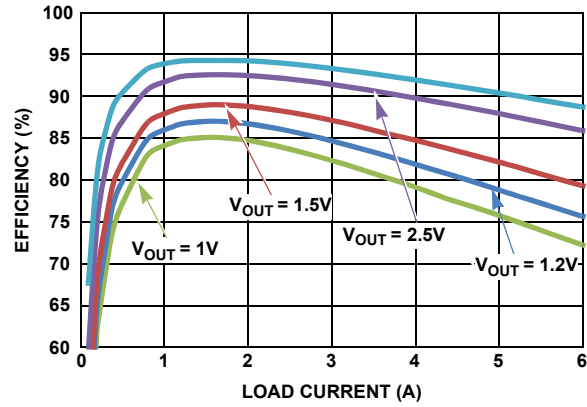

FIGURE 9. EFFICIENCY, PARALLEL SINGLE OUTPUT, $V_{IN} = 5V$

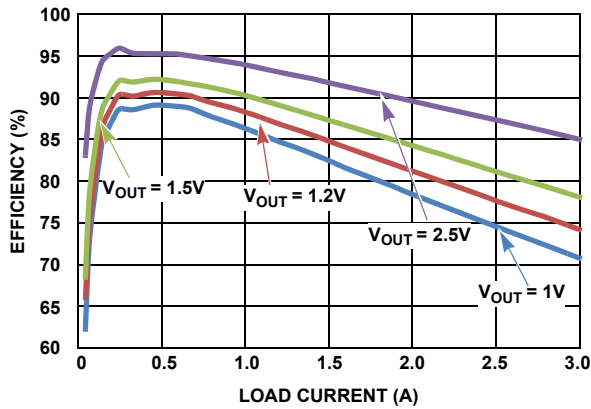

FIGURE 10. EFFICIENCY, SINGLE CHANNEL, $V_{IN} = 3.3V$

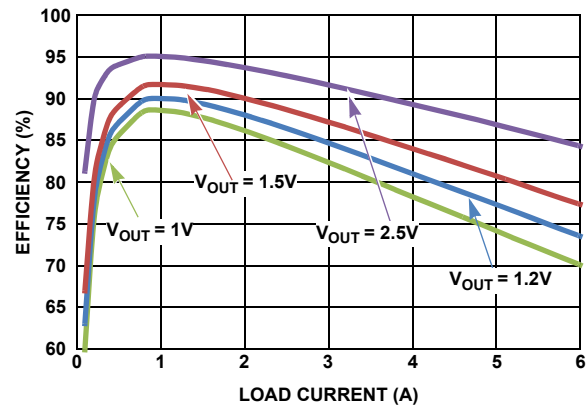

FIGURE 11. EFFICIENCY, PARALLEL SINGLE OUTPUT, $V_{IN} = 3.3V$

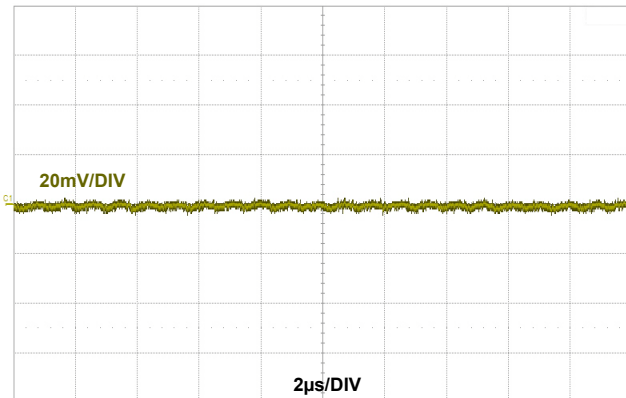

FIGURE 12. OUTPUT VOLTAGE RIPPLE AT $V_{IN} = 5V$, $V_{OUT} = 1.5V$, PARALLEL SINGLE OUTPUT, $I_{OUT} = 6A$, $C_{OUT} = 6 \times 22\mu F$ CERAMIC CAPACITORS

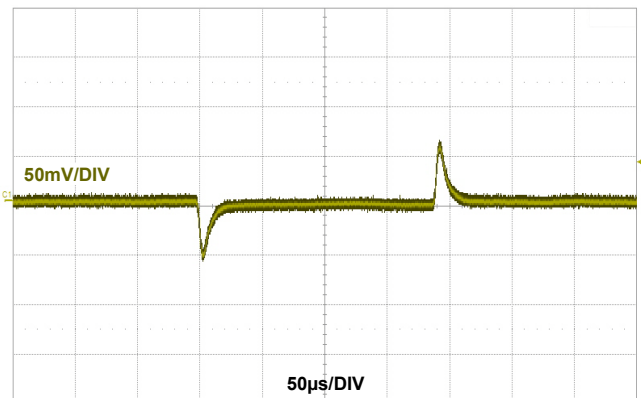

FIGURE 13. LOAD TRANSIENT RESPONSE AT $V_{IN} = 5V$, $V_{OUT} = 1.2V$, PARALLEL SINGLE OUTPUT, 0A TO 3A LOAD STEP, $C_{OUT} = 6 \times 22\mu F$, LOAD CURRENT SLEW RATE: $1A/\mu s$

ISL8203MEVAL2Z Performance Data (Continued)

The following data was acquired using a ISL8203MEVAL2Z evaluation board at +25°C ambient and free air OLFM.

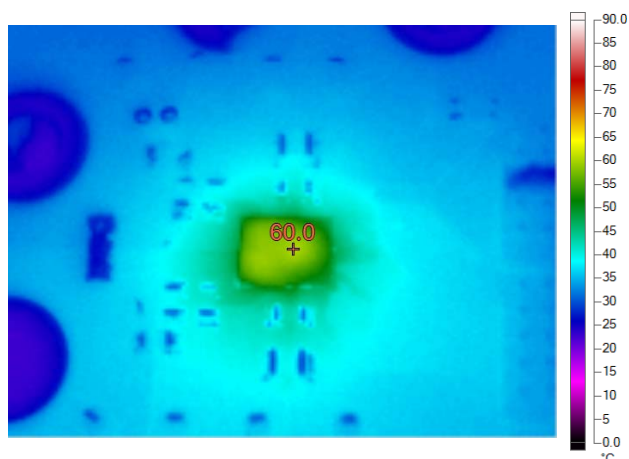

FIGURE 14. THERMAL IMAGE AT $V_{IN} = 5V$, $V_{OUT} = 1.5V$, $I_{OUT} = 6A$, PARALLEL SINGLE OUTPUT, $T_A = +25^\circ C$, FREE AIR OLFM

Notice

1. Descriptions of circuits, software and other related information in this document are provided only to illustrate the operation of semiconductor products and application examples. You are fully responsible for the incorporation or any other use of the circuits, software, and information in the design of your product or system. Renesas Electronics disclaims any and all liability for any losses and damages incurred by you or third parties arising from the use of these circuits, software, or information.
2. Renesas Electronics hereby expressly disclaims any warranties against and liability for infringement or any other claims involving patents, copyrights, or other intellectual property rights of third parties, by or arising from the use of Renesas Electronics products or technical information described in this document, including but not limited to, the product data, drawings, charts, programs, algorithms, and application examples.
3. No license, express, implied or otherwise, is granted hereby under any patents, copyrights or other intellectual property rights of Renesas Electronics or others.
4. You shall not alter, modify, copy, or reverse engineer any Renesas Electronics product, whether in whole or in part. Renesas Electronics disclaims any and all liability for any losses or damages incurred by you or third parties arising from such alteration, modification, copying or reverse engineering.
5. Renesas Electronics products are classified according to the following two quality grades: "Standard" and "High Quality". The intended applications for each Renesas Electronics product depends on the product's quality grade, as indicated below.
"Standard": Computers; office equipment; communications equipment; test and measurement equipment; audio and visual equipment; home electronic appliances; machine tools; personal electronic equipment; industrial robots; etc.
"High Quality": Transportation equipment (automobiles, trains, ships, etc.); traffic control (traffic lights); large-scale communication equipment; key financial terminal systems; safety control equipment; etc.
Unless expressly designated as a high reliability product or a product for harsh environments in a Renesas Electronics data sheet or other Renesas Electronics document, Renesas Electronics products are not intended or authorized for use in products or systems that may pose a direct threat to human life or bodily injury (artificial life support devices or systems; surgical implantations; etc.), or may cause serious property damage (space system; undersea repeaters; nuclear power control systems; aircraft control systems; key plant systems; military equipment; etc.). Renesas Electronics disclaims any and all liability for any damages or losses incurred by you or any third parties arising from the use of any Renesas Electronics product that is inconsistent with any Renesas Electronics data sheet, user's manual or other Renesas Electronics document.
6. When using Renesas Electronics products, refer to the latest product information (data sheets, user's manuals, application notes, "General Notes for Handling and Using Semiconductor Devices" in the reliability handbook, etc.), and ensure that usage conditions are within the ranges specified by Renesas Electronics with respect to maximum ratings, operating power supply voltage range, heat dissipation characteristics, installation, etc. Renesas Electronics disclaims any and all liability for any malfunctions, failure or accident arising out of the use of Renesas Electronics products outside of such specified ranges.
7. Although Renesas Electronics endeavors to improve the quality and reliability of Renesas Electronics products, semiconductor products have specific characteristics, such as the occurrence of failure at a certain rate and malfunctions under certain use conditions. Unless designated as a high reliability product or a product for harsh environments in a Renesas Electronics data sheet or other Renesas Electronics document, Renesas Electronics products are not subject to radiation resistance design. You are responsible for implementing safety measures to guard against the possibility of bodily injury, injury or damage caused by fire, and/or danger to the public in the event of a failure or malfunction of Renesas Electronics products, such as safety design for hardware and software, including but not limited to redundancy, fire control and malfunction prevention, appropriate treatment for aging degradation or any other appropriate measures. Because the evaluation of microcomputer software alone is very difficult and impractical, you are responsible for evaluating the safety of the final products or systems manufactured by you.
8. Please contact a Renesas Electronics sales office for details as to environmental matters such as the environmental compatibility of each Renesas Electronics product. You are responsible for carefully and sufficiently investigating applicable laws and regulations that regulate the inclusion or use of controlled substances, including without limitation, the EU RoHS Directive, and using Renesas Electronics products in compliance with all these applicable laws and regulations. Renesas Electronics disclaims any and all liability for damages or losses occurring as a result of your noncompliance with applicable laws and regulations.
9. Renesas Electronics products and technologies shall not be used for or incorporated into any products or systems whose manufacture, use, or sale is prohibited under any applicable domestic or foreign laws or regulations. You shall comply with any applicable export control laws and regulations promulgated and administered by the governments of any countries asserting jurisdiction over the parties or transactions.
10. It is the responsibility of the buyer or distributor of Renesas Electronics products, or any other party who distributes, disposes of, or otherwise sells or transfers the product to a third party, to notify such third party in advance of the contents and conditions set forth in this document.
11. This document shall not be reprinted, reproduced or duplicated in any form, in whole or in part, without prior written consent of Renesas Electronics.
12. Please contact a Renesas Electronics sales office if you have any questions regarding the information contained in this document or Renesas Electronics products.
(Note 1) "Renesas Electronics" as used in this document means Renesas Electronics Corporation and also includes its directly or indirectly controlled subsidiaries.
(Note 2) "Renesas Electronics product(s)" means any product developed or manufactured by or for Renesas Electronics.

(Rev.4.0-1 November 2017)



SALES OFFICES

Renesas Electronics Corporation

<http://www.renesas.com>

Refer to "<http://www.renesas.com/>" for the latest and detailed information.

Renesas Electronics America Inc.
1001 Murphy Ranch Road, Milpitas, CA 95035, U.S.A.
Tel: +1-408-432-8888, Fax: +1-408-434-5351

Renesas Electronics Canada Limited
9251 Yonge Street, Suite 8309 Richmond Hill, Ontario Canada L4C 9T3
Tel: +1-905-237-2004

Renesas Electronics Europe Limited
Dukes Meadow, Millboard Road, Bourne End, Buckinghamshire, SL8 5FH, U.K
Tel: +44-1628-651-700, Fax: +44-1628-651-804

Renesas Electronics Europe GmbH
Arcadiastrasse 10, 40472 Düsseldorf, Germany
Tel: +49-211-6503-0, Fax: +49-211-6503-1327

Renesas Electronics (China) Co., Ltd.
Room 1709 Quantum Plaza, No.27 ZhichunLu, Haidian District, Beijing, 100191 P. R. China
Tel: +86-10-8235-1155, Fax: +86-10-8235-7679

Renesas Electronics (Shanghai) Co., Ltd.
Unit 301, Tower A, Central Towers, 555 Langao Road, Putuo District, Shanghai, 200333 P. R. China
Tel: +86-21-2226-0888, Fax: +86-21-2226-0999

Renesas Electronics Hong Kong Limited
Unit 1601-1611, 16/F., Tower 2, Grand Century Place, 193 Prince Edward Road West, Mongkok, Kowloon, Hong Kong
Tel: +852-2265-6688, Fax: +852-2886-9022

Renesas Electronics Taiwan Co., Ltd.
13F, No. 363, Fu Shing North Road, Taipei 10543, Taiwan
Tel: +886-2-8175-9600, Fax: +886-2-8175-9670

Renesas Electronics Singapore Pte. Ltd.
80 Bendemeer Road, Unit #06-02 Hyflux Innovation Centre, Singapore 339949
Tel: +65-6213-0200, Fax: +65-6213-0300



Renesas Electronics Malaysia Sdn.Bhd.
Unit 1207, Block B, Menara Amcorp, Amcorp Trade Centre, No. 18, Jln Persiaran Barat, 46050 Petaling Jaya, Selangor Darul Ehsan, Malaysia
Tel: +60-3-7955-9390, Fax: +60-3-7955-9510

Renesas Electronics India Pvt. Ltd.
No.777C, 100 Feet Road, HAL 2nd Stage, Indiranagar, Bangalore 560 038, India
Tel: +91-80-67208700, Fax: +91-80-67208777

Renesas Electronics Korea Co., Ltd.
17F, KAMCO Yangjae Tower, 262, Gangnam-daero, Gangnam-gu, Seoul, 06265 Korea
Tel: +82-2-558-3737, Fax: +82-2-558-5338

Looking for pricing, stock, or lifecycle information?

Click below to explore more details on WIN SOURCE:

-  [View ISL8203MEVAL2Z on WIN SOURCE](#)
-  [Renesas Electronics America](#) Information

Optimize Your Supply Chain with WIN SOURCE Solutions

-  Global Sourcing Solution
-  Obsolete Management
-  Cost Control Management
-  Shortage Management
-  Alternative Solution
-  Excess Inventory Management