



**THE DATASHEET OF
RP10-2415DEW**



Features

- Wide 4:1 input voltage range
- 1.6kVDC isolation
- UL60950-1 certified
- Efficiency up to 84%
- Six-sided continuous shield
- Fixed operating frequency

Regulated Converter



RP10-EW

10 Watt
2" x 1"
Single and Dual Output



Description

The RP10-EW series wide input range DC/DC converters are certified to UL 60950-1 and cUL 60950-1. This makes them ideal for all telecom and industrial applications where approved safety standards are required. The industry standard 2" x 1" package meets military standards for thermal shock and vibration tolerance and is available with an optional remote on/off control pin.

Selection Guide

Part Number	Input Voltage Range [VDC]	Output Voltage [VDC]	Output Current [mA]	Input ⁽¹⁾ Current [mA]	Efficiency ⁽¹⁾ typ. [%]	Max. Capacitive Load ⁽²⁾ [μF]
RP10-243.3SEW ^(3,4)	9-36	3.3	2500	441	78	6800
RP10-2405SEW ^(3,4)	9-36	5	2000	521	80	4700
RP10-2412SEW ^(3,4)	9-36	12	830	494	84	690
RP10-2415SEW ^(3,4)	9-36	15	670	517	81	470
RP10-483.3SEW ^(3,4)	18-75	3.3	2500	226	76	6800
RP10-4805SEW ^(3,4)	18-75	5	2000	322	81	4700
RP10-4812SEW ^(3,4)	18-75	12	830	247	84	690
RP10-4815SEW ^(3,4)	18-75	15	670	249	84	470
RP10-2405DEW ^(3,4)	9-36	±5	±1000	508	82	±680
RP10-2412DEW ^(3,4)	9-36	±12	±416	520	80	±330
RP10-2415DEW ^(3,4)	9-36	±15	±333	520	80	±110
RP10-4805DEW ^(3,4)	18-75	±5	±1000	254	82	±680
RP10-4812DEW ^(3,4)	18-75	±12	±416	267	78	±330
RP10-4815DEW ^(3,4)	18-75	±15	±333	257	81	±110

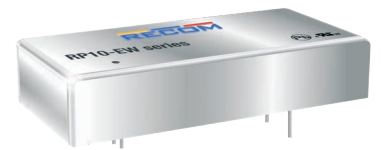

Notes:

- Note1: Maximum values at nominal input voltage and full load
 Note2: Max. Cap load is tested at minimum input and constant resistive load

UL60950-1 certified
EN55032 compliant

Model Numbering

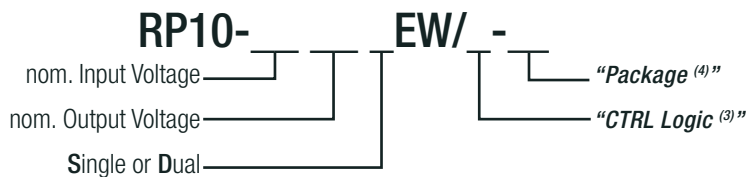

Notes:

- Note3: no suffix for standard part without CTRL pin
 add suffix "P" for CTRL function with positive logic (1=ON, 0=OFF)
 add suffix "N" for CTRL function with negative logic (0=ON, 1=OFF)
 Note4: add suffix "-HC" for premounted Heat-sink with clips

Ordering Examples

RP10-2405SEW/P = 24V input, 5V output, single, positive Logic CTRL pin
 RP10-4805DEW/N-HC = 48V input, ±5V output, dual, negative Logic CTRL pin, Heat-sink premounted

Specifications (measured @ Ta= 25°C, nom. Vin, full load unless otherwise stated)

BASIC CHARACTERISTICS					
Parameter	Condition		Min.	Typ.	Max.
Input Filter					Pi-Type
Input Voltage Range	nom. Vin = 24VDC nom. Vin = 48VDC		9VDC 18VDC	24VDC 48VDC	36VDC 75VDC
Input Surge Voltage	100ms max.	nom. Vin = 24VDC nom. Vin = 48VDC			50VDC 100VDC
Input Reflected Ripple Current ⁽⁵⁾				30mA _{p-p}	
Minimum Load ⁽⁶⁾			10%		
Start-up Time	Power up			20ms	
ON/OFF CTRL ⁽⁷⁾	Positive Logic	DC-DC ON DC-DC OFF	Open or 3.5VDC < V _{CTRL} < 12VDC Short or 0VDC < V _{CTRL} < 1.2VDC		
	Negative Logic	DC-DC ON DC-DC OFF	Short or 0VDC < V _{CTRL} < 1.2VDC Open or 3.5VDC < V _{CTRL} < 12VDC		
Input Current of CTRL pin	DC-DC ON		-0.5mA		+1.0mA
Standby Current	DC-DC OFF			20mA	
Internal Operating Frequency			270kHz	300kHz	330kHz
Ripple and Noise	20MHz BW	Single Dual		50mV _{p-p} 75mV _{p-p}	

Notes:

- Note5: Simulated source impedance of 12μH. 12μH inductor in series with +Vin
- Note6: The RP10-EW series requires a minimum of 10% loading on the output to maintain specified regulation. Operation under no-load condition will not damage these devices, however they may not meet all listed specification
- Note7: If no suffix is specified, pin6 will be absent.
If fitted, the ON/OFF control function can be positive or negative logic. The pin voltage is referenced to -Vin pin

RP10-2405SEW

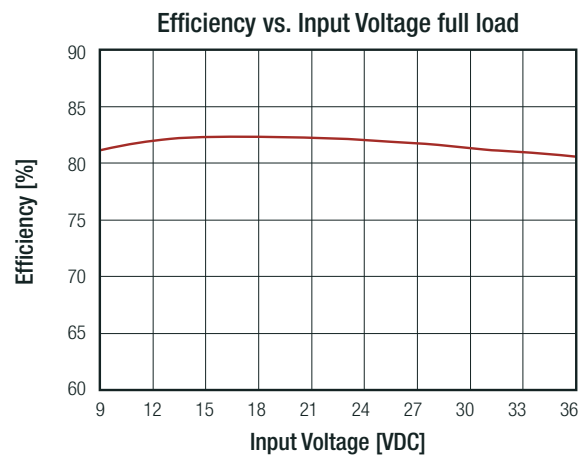
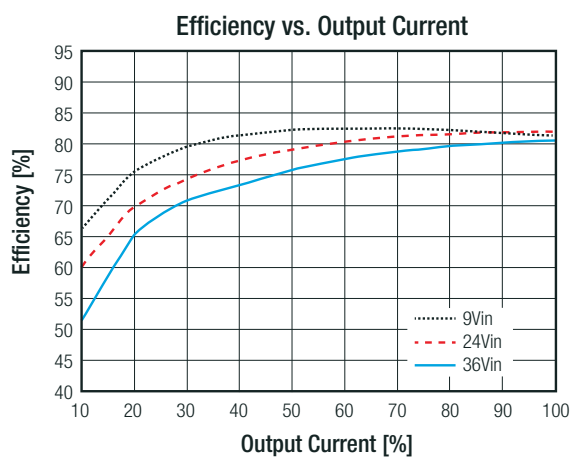

continued on next page

Specifications (measured @ Ta= 25°C, nom. Vin, full load unless otherwise stated)

RP20-4805SFW

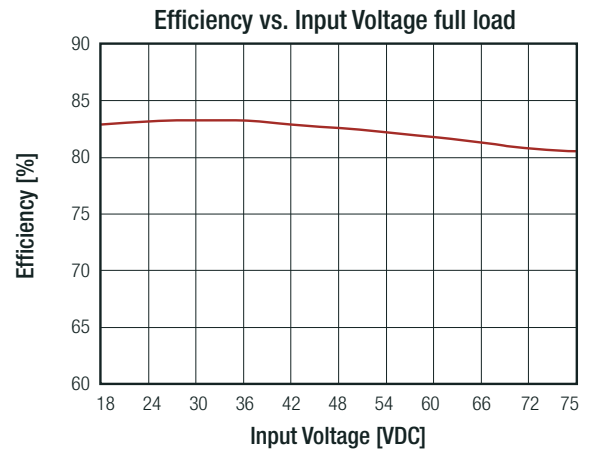
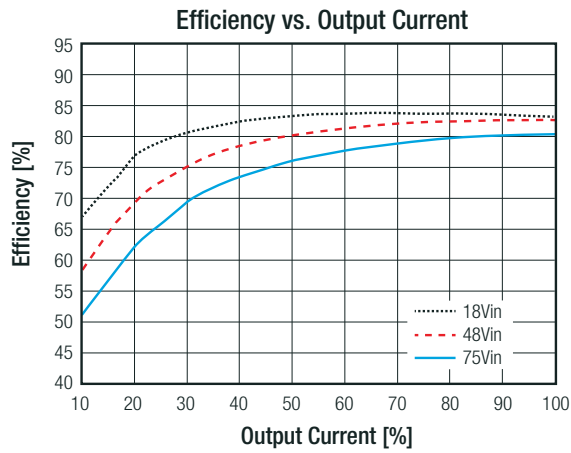

REGULATIONS

Parameter	Condition		Value
Output Accuracy			±1.0%
Line Regulation	low line to high line, full load		±0.2%
Load Regulation	0% to 100% load	Single	±0.5%
		Dual	±1.0%
Cross Regulation	asymmetrical 25%<>100% load		±5.0%
Transient Response Recovery Time	25% load step change		250µs typ.

PROTECTIONS

Parameter	Condition		Value
Short Circuit Protection (SCP)			continuous, automatic recovery
Over Voltage Protection (OVP)	zener diode clamp	3.3Vout	3.9VDC
		5Vout	6.2VDC
		12Vout	15VDC
		15Vout	18VDC
Over Load Protection (OLP)	% Iout rated		150% typ.
Isolation Voltage (8)	I/P to O/P		1.6kVDC/ 1 minute
	I/P to O/P to case		1.6kVDC/ 1 minute
Isolation Resistance	Viso= 500VDC		1GΩ min.
Isolation Capacitance			300pF max.

Notes:

Note8: For repeat Hi-Pot testing, reduce the time and/or the test voltage

Note9: This power module is not internally fused. An input line fuse must always be used

Specifications (measured @ Ta= 25°C, nom. Vin, full load unless otherwise stated)

ENVIRONMENTAL		
Parameter	Condition	Value
Operating Temperature Range	without derating	-40°C to +78°C
	with derating	-40°C to +94°C
Maximum Case Temperature		+105°C
Temperature Coefficient		±0.02%/K max.
Thermal Impedance	@ natural convection 0.1m/s	without heat-sink with heat-sink
		12K/W 10K/W
Operating Humidity	non-condensing	5% - 95% RH
Thermal Shock		according to MIL-STD-810F
Vibration		according to MIL-STD-810F
MTBF	MIL-HDBK-217F, G.B.	3342 x 10 ³ hours
	Bellcore TR-NWT-000332 ⁽¹⁰⁾	1976 x 10 ³ hours

Derating Graph ⁽¹¹⁾

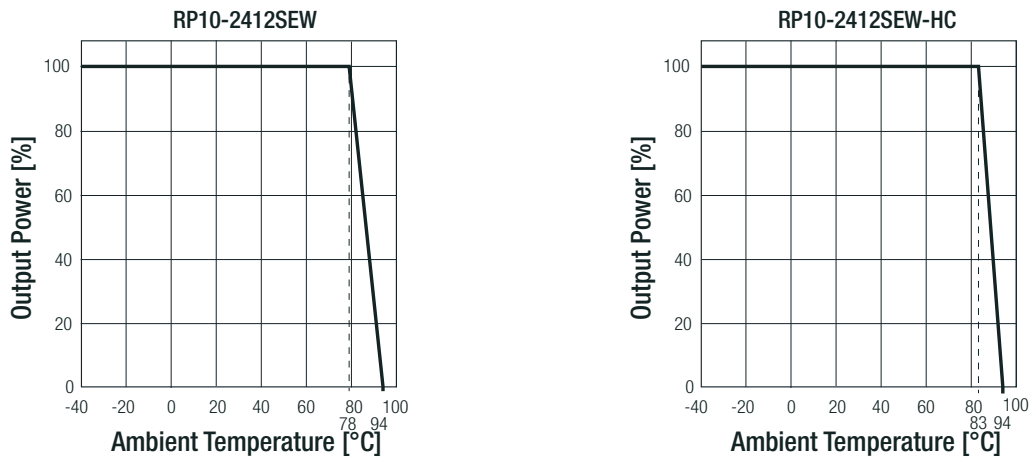

Notes:

- Note10: BELLCORE TR-NWT-000332. Case I: 50% Stress, Temperature at 40°C (Ground fixed and controlled environment)
- Note11: Derating graphs are valid only for the shown part numbers. If you need detailed derating-information about a part-number not shown here please contact RECOM Techsupport for detailed information

SAFETY AND CERTIFICATIONS		
Certificate Type (Safety)	Condition	Standard
Information Technology Equipment, General Requirements for Safety	E196683	UL60950-1, 2nd Edition, 2011 CAN/CSA-C22.2 No. 60950-1-07, 2nd Edition, 2011
EAC	RU-AT.49.09571	TP TC 004/2011
RoHS 2		RoHS-2011/65/EU + AM-2015/863
EMC Compliance	Condition	Standard / Criterion
Electromagnetic compatibility of multimedia equipment - Emission requirements	with external filter refer to <i>"EMC Filtering Suggestions"</i>	EN55032, Class A and B
ESD Electrostatic discharge immunity test	Air ±8kV and Contact ±6kV	EN61000-4-2, Criteria B
Radiated, radio-frequency, electromagnetic field immunity test	10 V/m	EN61000-4-3, Criteria A
Fast Transient and Burst Immunity ⁽¹²⁾	±2kV	EN61000-4-4, Criteria B
Surge Immunity ⁽¹²⁾	±2kV	EN61000-4-5, Criteria B
Immunity to conducted disturbances, induced by radio-frequency fields	10 Vr.m.s	EN61000-4-6, Criteria A
Power Magnetic Field Immunity	100A/m continuous; 1000A/m 1s	EN61000-4-8, Criteria A

continued on next page

Specifications (measured @ Ta= 25°C, nom. Vin, full load unless otherwise stated)

Notes:

Note12: An external input filter capacitor is required if the module has to meet EN61000-4-4, EN61000-4-5
 Recom suggests Nippon chemi-con KY series 220µF/100V

EMC Filtering Suggestions according to EN55032

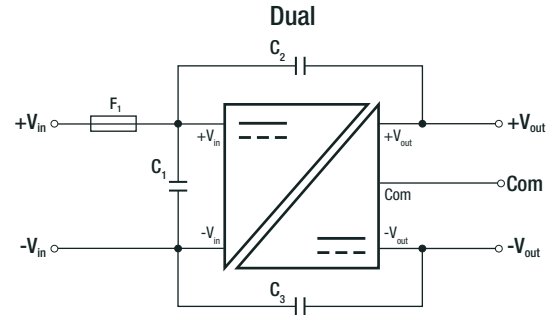
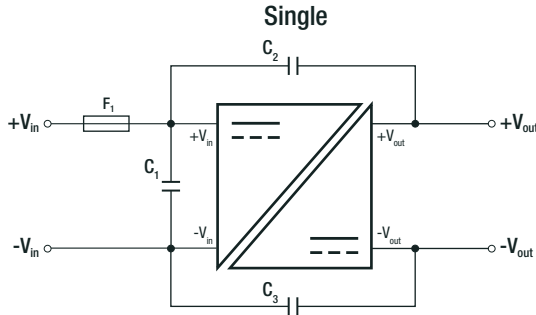

Component List Class A

MODEL	C1	C2	C3
RP10-24xxSEW	1µF/50V	1000pF/2kV	1000pF/2kV
RP10-24xxDEW	1210 MLCC	1808 MLCC	1808 MLCC
RP10-48xxSEW	1.5µF/100V	1000pF/2kV	1000pF/2kV
RP10-48xxDEW	1812 MLCC	1808 MLCC	1808 MLCC

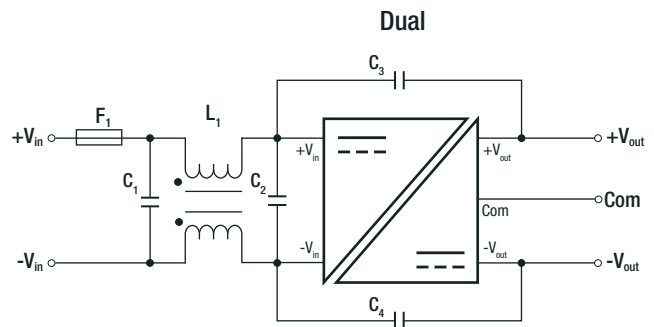
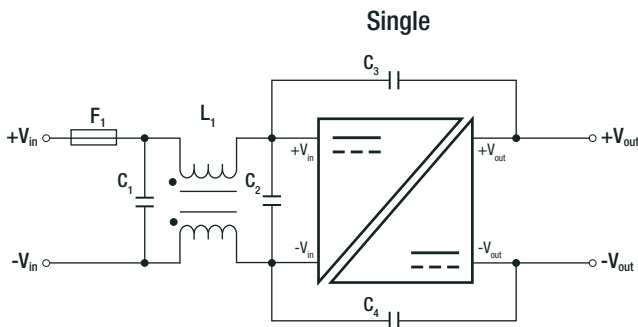

Component List Class B

MODEL	C1	C2	C3/C4	L1
RP10-24xxSEW	2.2µF/50V	N/A	1000pF/2kV	CMC: 325µH
RP10-24xxDEW	1812 MLCC		1808 MLCC	ref: WE 744290321 ref.: CMC-06
RP10-48xxSEW	2.2µF/50V	2.2µF/100V	1000pF/2kV	CMC: 325µH
RP10-48xxDEW	1812 MLCC	1812 MLCC	1808 MLCC	ref: WE 744290321 ref.: CMC-06

DIMENSIONS and PHYSICAL CHARACTERISTICS

Parameter	Type	Value
Material	case	nickel coated copper
	base	non-conductive black plastic
	potting	epoxy (UL94 V-0)
Dimensions (LxWxH)	without Heat-sink	50.8 x 25.4 x 10.2mm
	with Heat-sink	56.8 x 25.4 x 16.8mm
Weight	without Heat-sink	27g
	with Heat-sink	37.89g

continued on next page

Specifications (measured @ Ta= 25°C, nom. Vin, full load unless otherwise stated)

Dimension Drawing (mm)

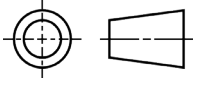
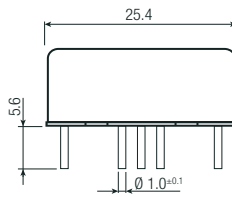
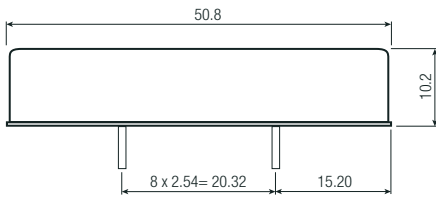

Pinning Information

Pin #	Single	Dual
1	+Vin	+Vin
2	-Vin	-Vin
3	+Vout	+Vout
4	no Pin	Com
5	-Vout	-Vout
6	CTRL ⁽³⁾	CTRL ⁽³⁾

Tolerance: xx.x= ±0.5mm
xx.xx= ±0.25mm

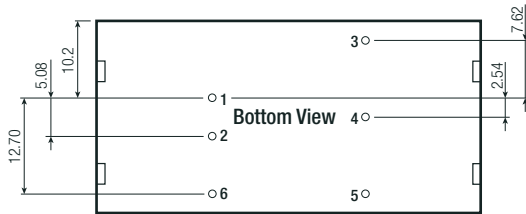

Recommended Footprint Details

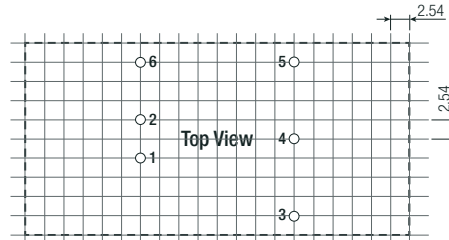

Dimension Drawing with Heat-sink (mm)

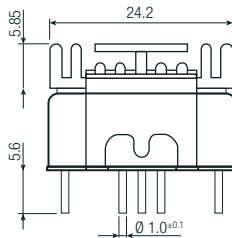
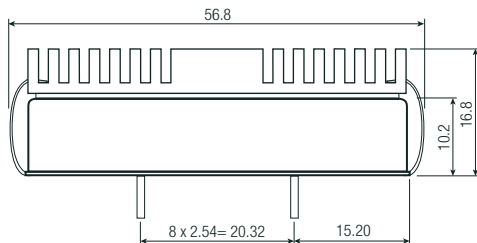
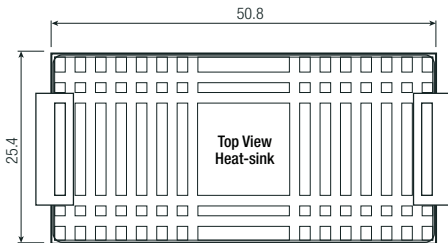

Recommended Footprint Details

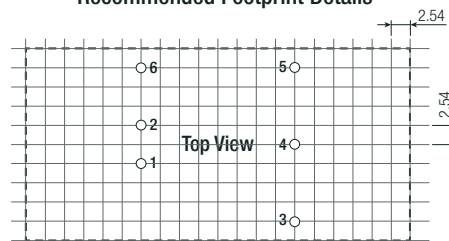
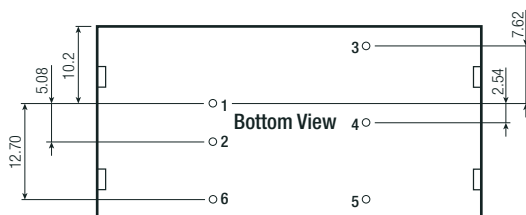



Specifications (measured @ Ta= 25°C, nom. Vin, full load unless otherwise stated)

PACKAGING INFORMATION			
Parameter	Type		Value
Packaging Dimension (LxWxH)	tube	without heat-sink	255.0 x 54.0 x 22.0mm
	tray	with heat-sink	302.5 x 222.0 x 20.0mm
Packaging Quantity	tube	without heat-sink	9pcs
	tray	with heat-sink	20pcs
Storage Temperature Range			-55°C to +125°C
Storage Humidity	non-condensing		5% - 95% RH

The product information and specifications may be subject to changes even without prior written notice. The product has been designed for various applications; its suitability lies in the responsibility of each customer. The products are not authorized for use in safety-critical applications without RECOM's explicit written consent. A safety-critical application is an application where a failure may reasonably be expected to endanger or cause loss of life, inflict bodily harm or damage property. The applicant shall indemnify and hold harmless RECOM, its affiliated companies and its representatives against any damage claims in connection with the unauthorized use of RECOM products in such safety-critical applications.

Looking for pricing, stock, or lifecycle information?

Click below to explore more details on WIN SOURCE:

-  [View RP10-2415DEW](#) on WIN SOURCE
-  [Recom Power](#) Information

Optimize Your Supply Chain with WIN SOURCE Solutions

-  Global Sourcing Solution
-  Obsolete Management
-  Cost Control Management
-  Shortage Management
-  Alternative Solution
-  Excess Inventory Management