



THE DATASHEET OF LXA7-PW57



For NEW designs consider this replacement product:

• LUXEON TX

LUXEON R

High flux for outdoor applications

LUXEON R brings illumination grade LED light sources to outdoor and industrial lighting applications and makes it easier than ever to design LED solutions and bring them to market. With hot testing, every LUXEON R is tested and specified at real world operating conditions — 85°C. *Freedom from Binning* means that every LUXEON R LED falls within a single 5-step MacAdam ellipse centered in ANSI defined standard color spaces and now, luminaire manufacturers can be confident in color consistency from LED to LED. The superior quality of light, volume of lumens, and real world efficacy enable leading performance and efficient solution development in a wide variety of high bay, low bay and outdoor applications.



FEATURES AND BENEFITS

5-step MacAdam color definition: *Freedom from Binning*

Identical footprint to LUXEON Rebel family and ecosystem for compatibility with existing designs

Hot tested at real world conditions which leads to better color accuracy

70CRI minimum and a full range of CCTs

PRIMARY APPLICATIONS

High Bay & Low Bay

Outdoor

Table of Contents

General Information	2
Product Nomenclature	2
Lumen Maintenance	2
Environmental Compliance	2
Product Selection	3
Optical Characteristics	3
Electrical Characteristics	4
Absolute Maximum Ratings	4
JEDEC Moisture Sensitivity	4
Reflow Soldering Characteristics	5
Mechanical Dimensions	6
Pad Configuration	7
Solder Pad Design	7
Typical Light Output Characteristics over Temperature	8
Typical Forward Current Characteristics	9
Current Derating Curves	10
Typical Radiation Patterns	12
Emitter Pocket Tape Packaging	13
Emitter Reel Packaging	14
Product Binning and Labeling	15
Luminous Flux Bins	16
LUXEON R 5-step MacAdam Ellipse Color Definition	17
Forward Voltage Bins	17

General Information

Product Nomenclature

LUXEON R emitters are tested and binned “hot” under conditions comparable to those found in “real-world” lighting products. The test conditions for LUXEON R are 700mA D.C. with junction temperature at 85°C.

The part number designation for the LUXEON R emitters is explained as follows:

L X A 7 - P W x x

Where:

- 7 — designates minimum CRI performance (value 7 = 70 minimum)
- P — designates radiation pattern (value P for Lambertian)
- W — designates color (value W = White)
- xx — designates nominal ANSI CCT (value 30 = 3000K, 40 = 4000K, 50 = 5000K, 57 = 5700K, and 65 = 6500K)

Lumen Maintenance

LUXEON R products are tested in compliance with LM-80. Please visit www.lumileds.com or contact your local Lumileds Technical Solutions Manager for TM-21 extrapolations or other support.

Environmental Compliance

Lumileds is committed to providing environmentally friendly products to the solid-state lighting market. LUXEON R is compliant to the European Union directives on the restriction of hazardous substances in electronic equipment, namely the RoHS and REACH directives. Lumileds will not intentionally add the following restricted materials to the LUXEON R: lead, mercury, cadmium, hexavalent chromium, polybrominated biphenyls (PBB) or polybrominated diphenyl ethers (PBDE).

Product Selection

Product Selection Guide for LUXEON R Emitters Junction Temperature = 85°C

Table 1.

Typical Performance Characteristics at 350mA, 700mA, and 1000mA for LUXEON R, Junction Temperature = 85°C													
Part Number	Nominal ANSI CCT	CRI @ 700mA		Luminous Flux (lm) Min	Typical Luminous Flux (lm)			Typical Forward Voltage (V _f)			Typical Efficacy (lm/W)		
		Min.	Typ.	700mA	350 mA	700 mA	1000 mA	350 mA	700 mA	1000 mA	350 mA	700 mA	1000 mA
LXA7-PW30	3000K	70	75	160	100	180	245	2.72	2.81	2.85	105	92	86
LXA7-PW40	4000K	70	75	200	119	215	292	2.72	2.81	2.85	125	109	103
LXA7-PW50	5000K	70	75	200	122	220	299	2.72	2.81	2.85	128	112	105
LXA7-PW57	5700K	70	75	200	122	220	299	2.72	2.81	2.85	128	112	105
LXA7-PW65	6500K	70	75	200	122	220	299	2.72	2.81	2.85	128	112	105

Notes for Table 1:

1. Minimum luminous flux performance within published operating conditions. Lumileds maintains a tolerance of ± 6.5% on luminous flux measurements.
2. Lumileds maintains a tolerance of ± 0.06V on forward voltage measurements.

Optical Characteristics

LUXEON R at Test Current ^[1] Junction Temperature = 85°C

Table 2.

Nominal ANSI CCT	Part Number	Typical Color Temperature CCT	Typical Total Included Angle ^[2] (degrees) $\theta_{0.90V}$	Typical Viewing Angle ^[3] (degrees) $2\theta_{1/2}$
3000K	LXA7-PW30	3045K	160	120
4000K	LXA7-PW40	3985K		
5000K	LXA7-PW50	5028K		
5700K	LXA7-PW57	5665K		
6500K	LXA7-PW65	6530K		

Notes for Table 2:

1. Test current is 700mA D.C. for all LXA7-PWxx emitters.
2. Total angle at which 90% of total luminous flux is captured.
3. Viewing angle is the off axis angle from lamp centerline where the luminous intensity is 1/2 of the peak value.

Electrical Characteristics

Electrical Characteristics at 700mA for LUXEON R Junction Temperature = 85°C

Table 3.

Nominal ANSI CCT	Forward Voltage V_f (V) ^[1]		Typical Temperature Coefficient of Forward Voltage ^[2] (mV/°C) $\Delta V_f / \Delta T_J$	Typical Thermal Resistance Junction to Thermal Pad $R\theta_{J-C}$ (°C/W)
	Minimum	Maximum		
3000K	2.5	3.25	-1.8 to -2.4	6
4000K	2.5	3.25	-1.8 to -2.4	6
5000K	2.5	3.25	-1.8 to -2.4	6
5700K	2.5	3.25	-1.8 to -2.4	6
6500K	2.5	3.25	-1.8 to -2.4	6

Notes for Table 3:

1. Lumileds maintains a tolerance of $\pm 0.06V$ on forward voltage measurements.
2. Measured between $T_J = 25^\circ C$ and $T_J = 110^\circ C$ at $I_f = 700mA$.

Absolute Maximum Ratings

Table 4.

Parameter	LUXEON R
DC Forward Current (mA)	1000 ^[2]
Peak Pulsed Forward Current (mA)	1200 ^[3]
ESD Sensitivity	< 8000V Human Body Model (HBM) Class 3A JESD22-A114-E
LED Junction Temperature ^[1]	150°C
Operating Case Temperature at 700mA	-40°C - 135°C
Storage Temperature	-40°C - 135°C
Soldering Temperature	JEDEC 020c 260°C
Allowable Reflow Cycles	3
Reverse Voltage (Vr)	LUXEON R LEDs are not designed to be driven in reverse bias

Notes for Table 4:

1. Proper current derating must be observed to maintain junction temperature below the maximum. For additional information on thermal measurement guidelines please refer to Application Brief AB33.
2. Residual periodic variations due to power conversion from alternating current (AC) to direct current (DC), also called 'ripple', with frequencies ≥ 100 Hz and amplitude $\leq 200mA$ are acceptable, assuming the average current throughout each cycle does not exceed 1000mA.
3. Pulsed operation with a peak drive current of 1200mA is acceptable if the pulse on-time is ≤ 5 ms per cycle and the duty cycle is $\leq 50\%$.

JEDEC Moisture Sensitivity

Table 5.

Level	Floor Life		Soak Requirements Standard	
	Time	Conditions	Time	Conditions
1	unlimited	$\leq 30^\circ C$ / 85% RH	168h + 5 / - 0	85°C / 85% RH

Reflow Soldering Characteristics

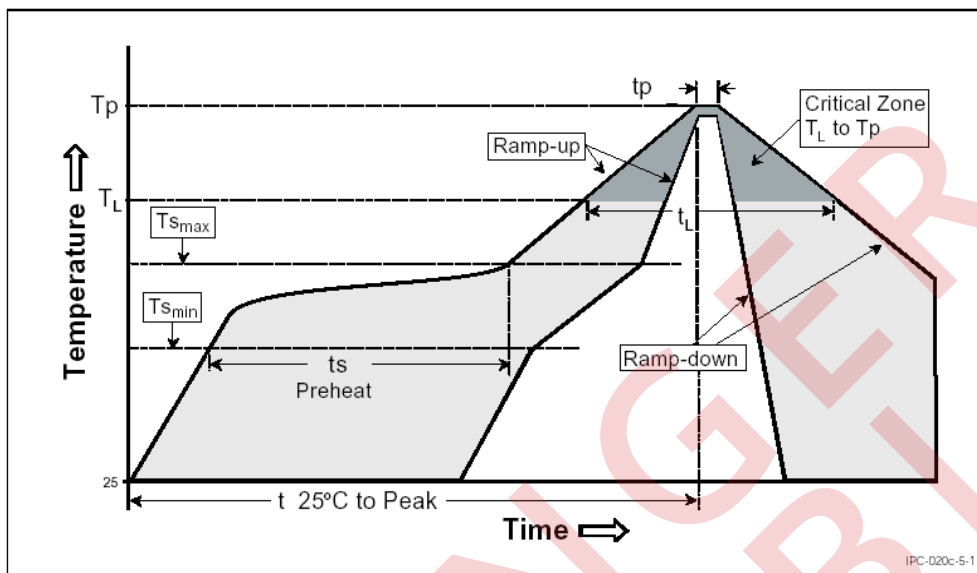

Temperature Profile for Table 6.

Table 6.

Profile Feature	Lead Free Assembly
Average Ramp-Up Rate ($T_{s_{max}}$ to T_p)	3°C / second max
Preheat Temperature Min ($T_{s_{min}}$)	150°C
Preheat Temperature Max ($T_{s_{max}}$)	200°C
Preheat Time ($t_{s_{min}}$ to $t_{s_{max}}$)	60 - 180 seconds
Temperature (T_L)	217°C
Time Maintained Above Temperature (T_L)	60 - 150 seconds
Peak / Classification Temperature (T_p)	260°C
Time Within 5°C of Actual Peak Temperature (t_p)	20 - 40 seconds
Ramp-Down Rate	6°C / second max
Time 25°C to Peak Temperature	8 minutes max

Notes for Table 6:

1. All temperatures refer to the application Printed Circuit Board (PCB), measured on the surface adjacent to the package body.

Mechanical Dimensions

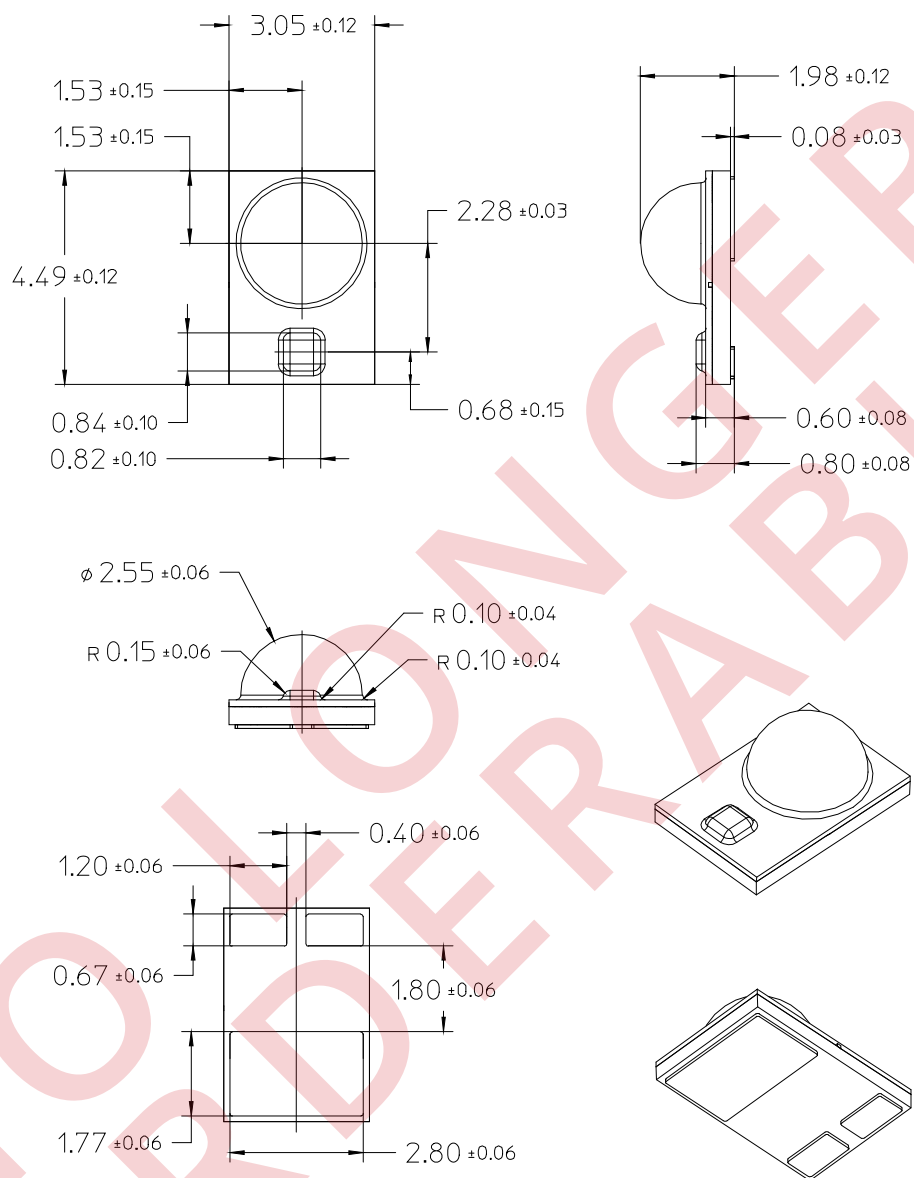

Figure 1. Package outline drawing.

Notes for Figure 2:

1. Do not handle the device by the lens. Care must be taken to avoid damage to the lens or the interior of the device that can be damaged by excessive force to the lens.
2. Drawings not to scale. All dimensions are in millimeters.
3. The thermal pad is electrically isolated from the anode and cathode contact pads.

Pad Configuration

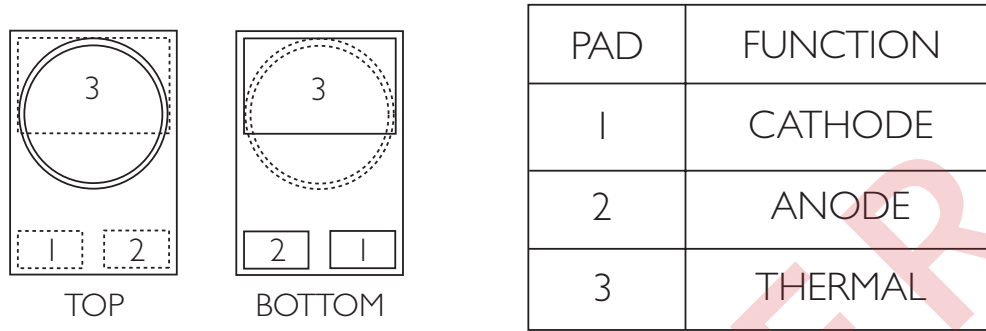

Figure 2. Pad configuration.

Notes for Figure 2:

1. The Thermal Pad is electrically isolated from the Anode and Cathode contact pads.

Solder Pad Design

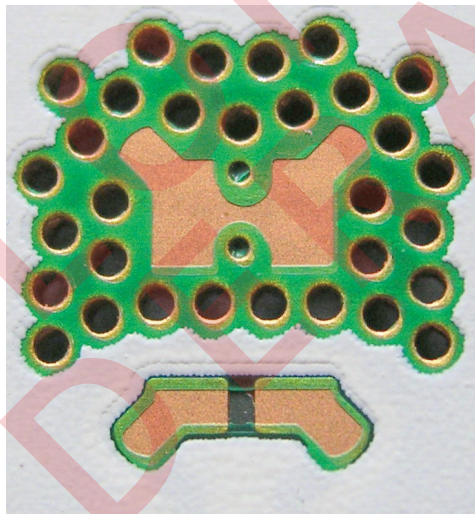

Figure 3. Solder pad layout.

Notes for Figure 2:

1. The photograph shows the recommended LUXEON R layout on Printed Circuit Board (PCB). This design easily achieves a thermal resistance of 7K/W.
2. Application Brief AB32 provides extensive details for this layout. Printed Circuit Board layout files (.dwg) are available at www.lumileds.com.

Typical Light Output Characteristics over Temperature

All LUXEON R Emitters at Test Current

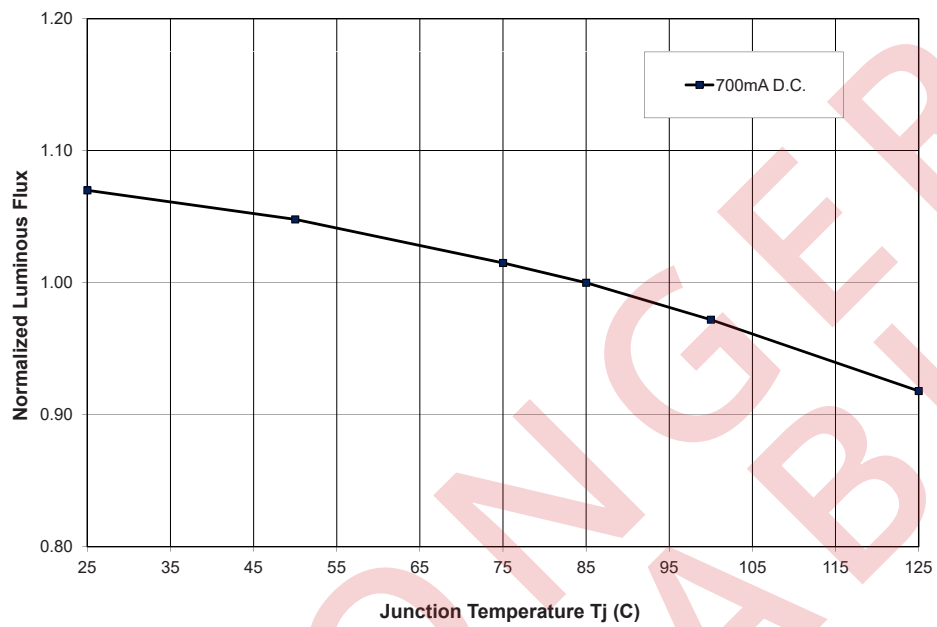

Figure 4. Relative light output vs. junction temperature.

Typical Forward Current Characteristics

All LUXEON R Emitters, Junction Temperature = 85°C

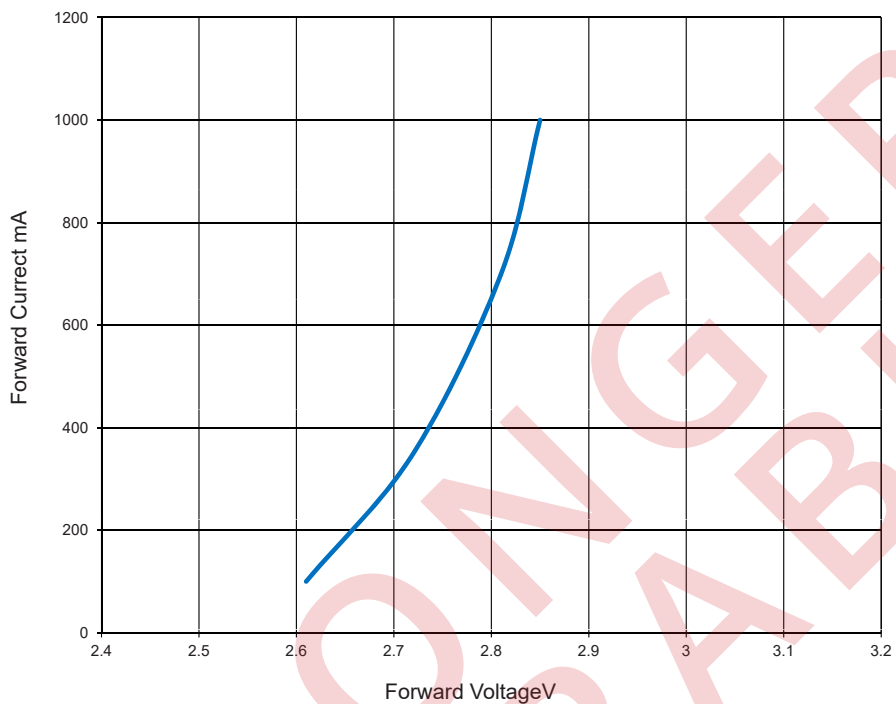

Figure 5. Forward current vs. forward voltage.

Typical Relative Luminous Flux vs. Forward Current for All LUXEON R Emitters, Junction Temperature = 85°C

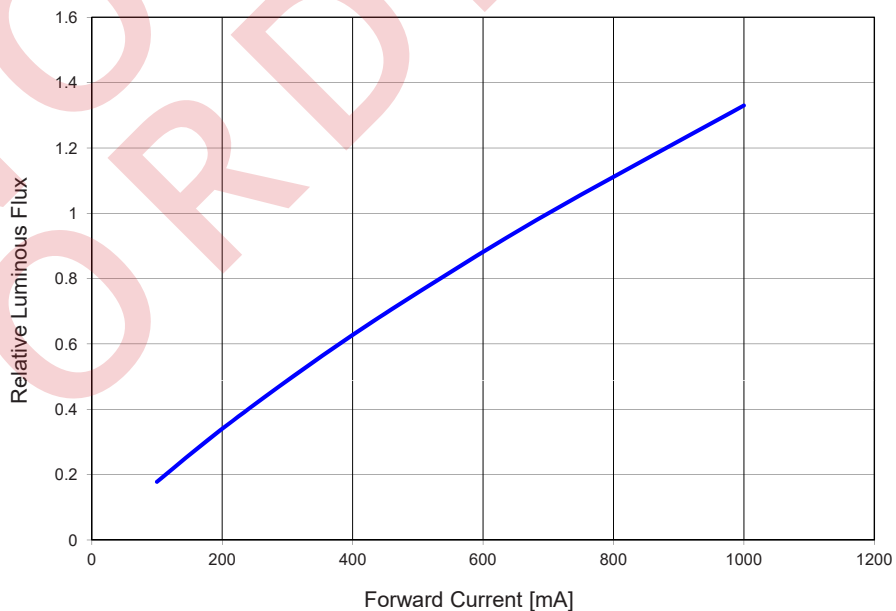

Figure 6. Typical relative luminous flux vs. forward current, junction temperature = 85°C.

Current Derating Curves

Current Derating Curve for 350mA Drive Current, All LUXEON R Emitters

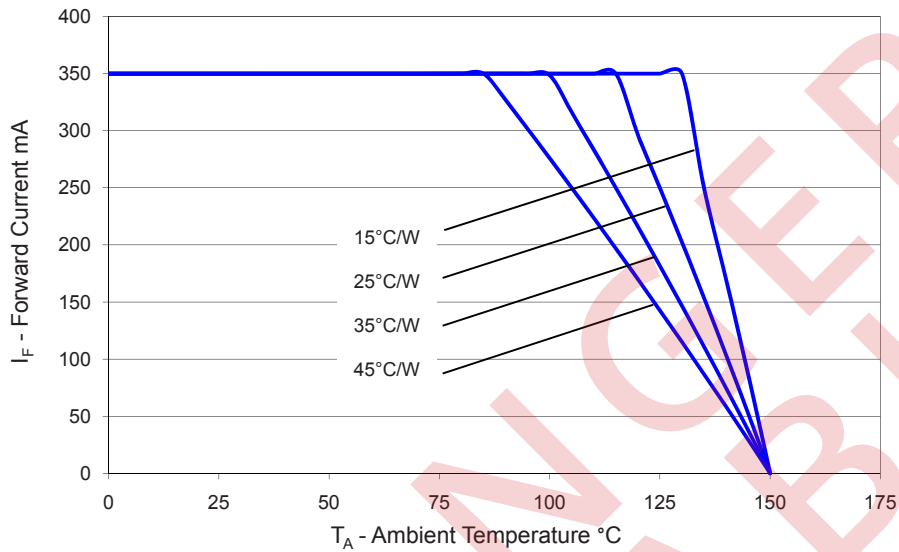

Figure 7. Maximum forward current vs. ambient temperature, based on $T_{JMAX} = 150^\circ\text{C}$.

Current Derating Curve for 700mA Drive Current, All LUXEON R Emitters

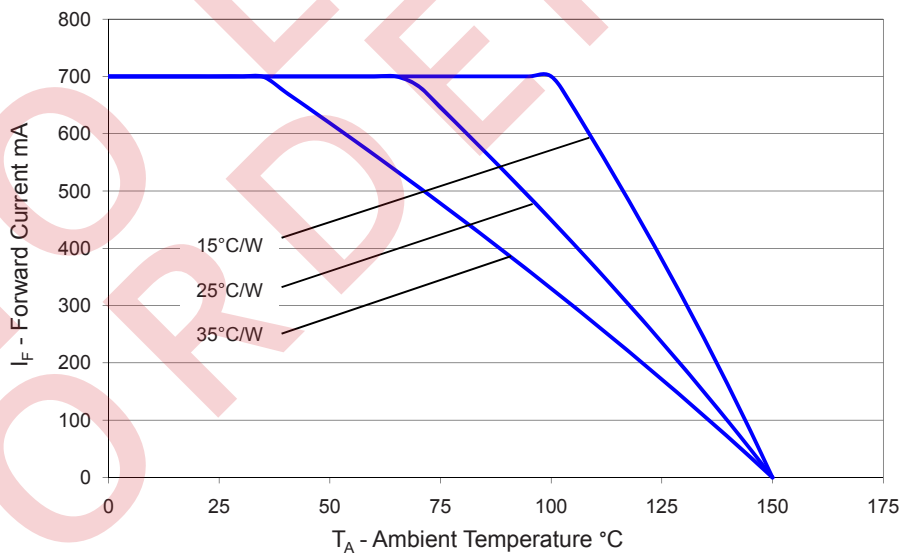

Figure 8. Maximum forward current vs. ambient temperature, based on $T_{JMAX} = 150^\circ\text{C}$.

Current Derating Curve for 1000mA Drive Current, All LUXEON R Emitters

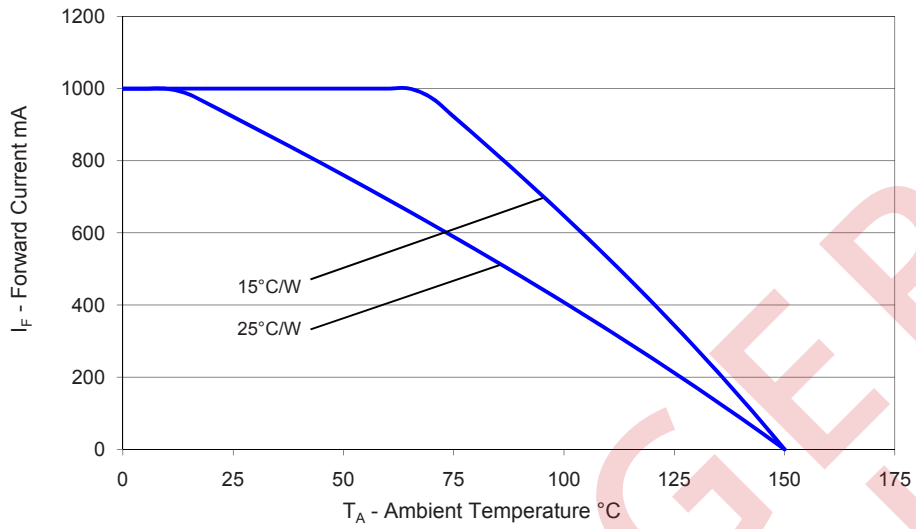

Figure 9. Maximum forward current vs. ambient temperature, based on $T_{JMAX} = 150^\circ\text{C}$.

Typical Radiation Patterns

Typical Luminous Intensity Distribution Pattern for LUXEON R Emitters

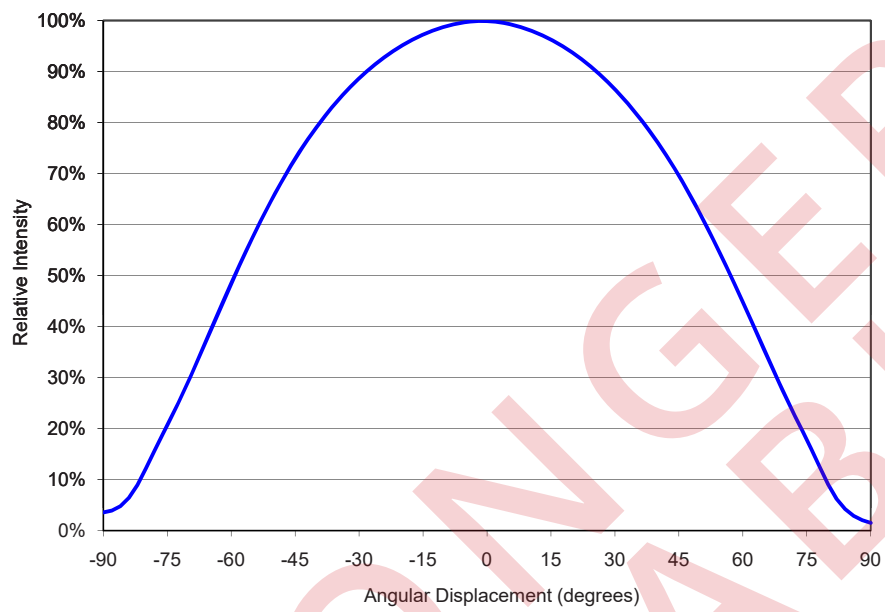
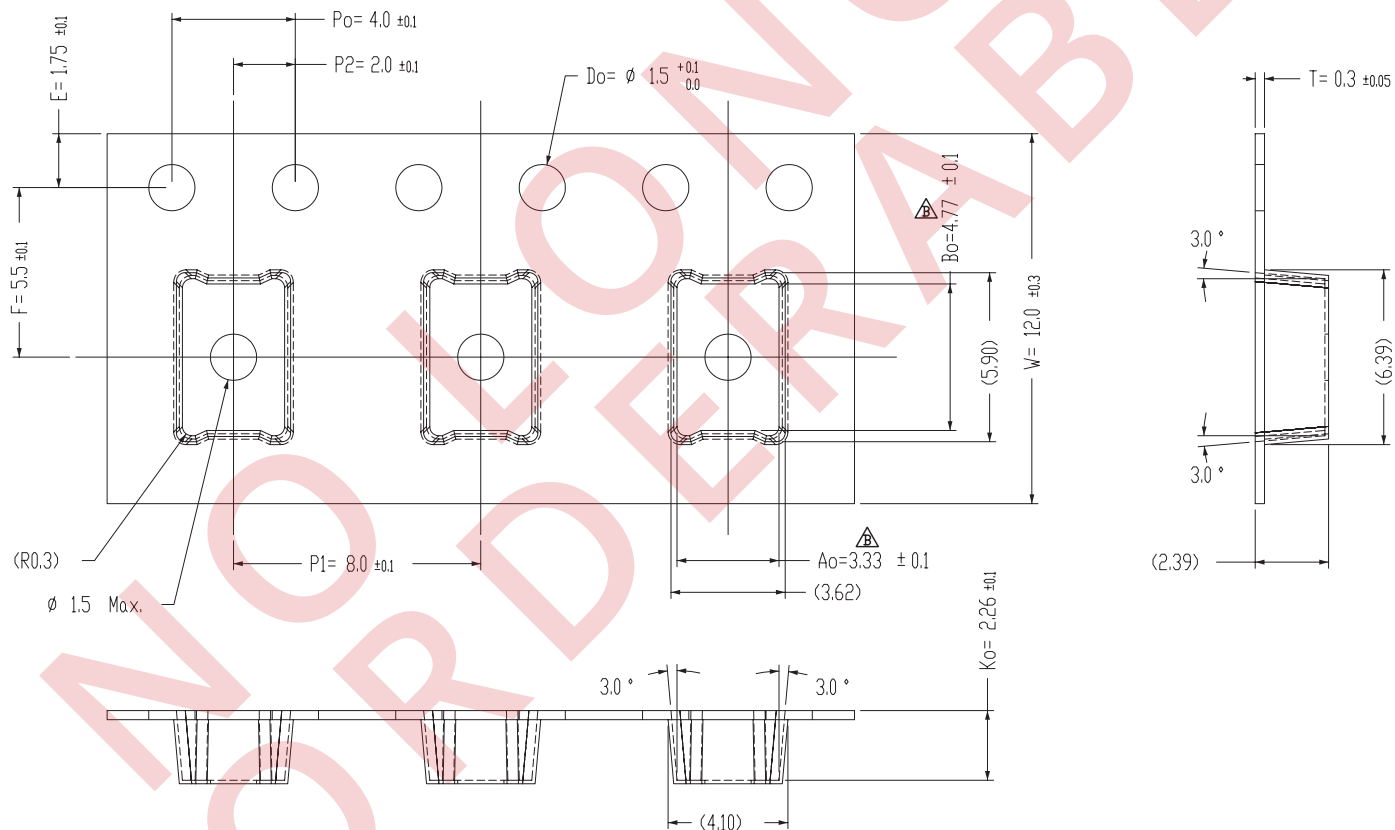
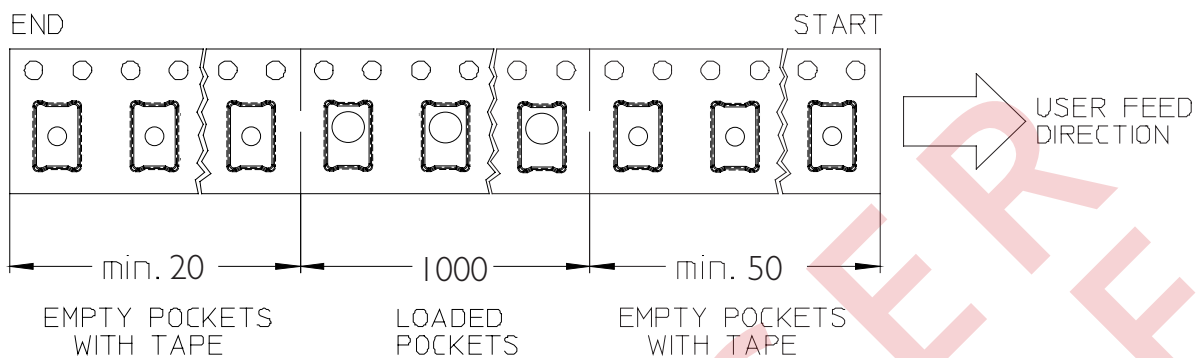
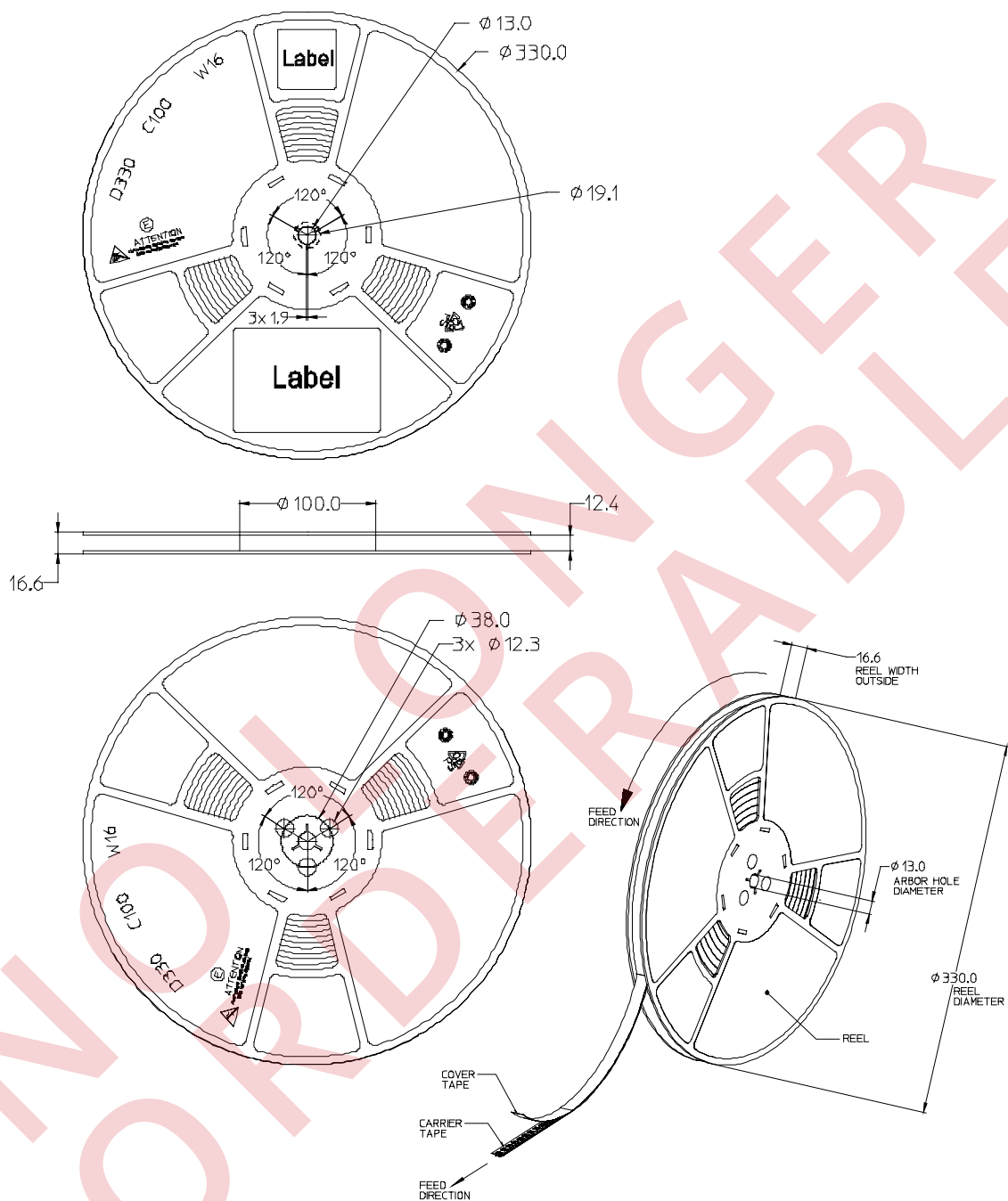

Figure 10. Cartesian plot of typical luminous intensity.

Emitter Pocket Tape Packaging



Emitter Reel Packaging



Product Binning and Labeling

Purpose of Product Binning

In the manufacturing of semiconductor products, there is a variation of performance around the average values given in the technical data sheets. For this reason, Lumileds bins the LED components for luminous flux and forward voltage (V_f). Color is offered in a single 5-step MacAdam ellipse color space centered on the ANSI CCT color bins. For additional information please review the MacAdam ellipse technical definition section.

Decoding Product Bin Labeling

LUXEON R emitters are labeled using a two digit alphanumeric code (CAT code) depicting the bin values for emitters packaged on a single reel. All emitters packaged within a reel are of the same 2-variable bin combination. Using these codes, it is possible to determine optimum mixing and matching of products for consistency in a given application.

Reels of LUXEON R emitters are labeled with a two digit alphanumeric CAT code following the format below.

AB

A = Flux bin (J, K, L, M, N, P and Q)

B = V_f bin (P, R, and S)

Luminous Flux Bins

Table 7 lists the standard photometric luminous flux bins for LUXEON R emitters (tested and binned at 700mA D.C., Junction Temperature = 85°C. Minimum luminous flux performance within published operating conditions. Lumileds maintains a tolerance of $\pm 6.5\%$ on luminous flux measurements.

Although several bins are outlined, product availability in a particular bin varies by production run and by product performance. Not all bins are available in all CCT's.

Table 7. Flux Bins

Bin Code	Minimum Photometric Flux (lm)	Maximum Photometric Flux (lm)
G	160	170
H	170	180
J	180	190
K	190	200
L	200	210
M	210	220
N	220	230
P	230	240
Q	240	250
R	250	260
S	260	270
T	270	280
U	280	290
V	290	300
W	300	310

Notes for Table 7:

1. Minimum luminous flux performance within published operating conditions. Lumileds maintains a tolerance of $\pm 6.5\%$ on luminous flux measurements.

LUXEON R 5-step MacAdam Ellipse Color Definition

Tested at 700mA D.C. & Junction Temperature = 85°C

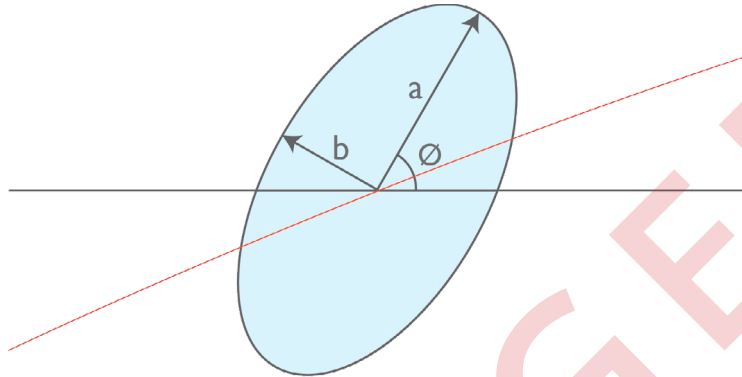

Table 8. LUXEON R Product Characteristics

Part Number	Nominal ANSI CCT	Color Space	Center Point (cx, cy)	Major Axis, a	Minor Axis, b	Ellipse Rotation Angle
LXA7-PW30	3000K	Single 5-step MacAdam ellipse	(0.4338, 0.4030)	0.01390	0.00680	53.22
LXA7-PW40	4000K	Single 5-step MacAdam ellipse	(0.3818, 0.3797)	0.01565	0.00670	53.72
LXA7-PW50	5000K	Single 5-step MacAdam ellipse	(0.3447, 0.3553)	0.01370	0.00590	59.62
LXA7-PW57	5700K	Single 5-step MacAdam ellipse	(0.3287, 0.3417)	0.01243	0.00533	59.09
LXA7-PW65	6500K	Single 5-step MacAdam ellipse	(0.3123, 0.3282)	0.01115	0.00475	58.57

Notes for Table 8:

1. Lumileds maintains a tester tolerance of ± 0.005 on x, y color coordinates.

Forward Voltage Bins

Table 9 lists minimum and maximum V_f bin values per emitter (tested and binned at 700mA). Although several bins are outlined, product availability in a particular bin varies by production run and by product performance.

Table 9. V_f Bins

Bin Code	Minimum Forward Voltage (V)	Maximum Forward Voltage (V)
P	2.50	2.75
R	2.75	3.00
S	3.00	3.25

Notes for Table 9:

1. Minimum luminous flux performance within published operating conditions. Lumileds maintains a tolerance of $\pm 6.5\%$ on luminous flux measurements.

About Lumileds

Companies developing automotive, mobile, IoT and illumination lighting applications need a partner who can collaborate with them to push the boundaries of light. With over 100 years of inventions and industry firsts, Lumileds is a global lighting solutions company that helps customers around the world deliver differentiated solutions to gain and maintain a competitive edge. As the inventor of Xenon technology, a pioneer in halogen lighting and the leader in high performance LEDs, Lumileds builds innovation, quality and reliability into its technology, products and every customer engagement. Together with its customers, Lumileds is making the world safer, better and more beautiful—with light.

To learn more about our lighting solutions, visit lumileds.com.

NO LONGER AVAILABLE



©2018 Lumileds Holding B.V. All rights reserved. LUXEON is a registered trademark of the Lumileds Holding B.V. in the United States and other countries.

lumileds.com

Neither Lumileds Holding B.V. nor its affiliates shall be liable for any kind of loss of data or any other damages, direct, indirect or consequential, resulting from the use of the provided information and data. Although Lumileds Holding B.V. and/or its affiliates have attempted to provide the most accurate information and data, the materials and services information and data are provided "as is," and neither Lumileds Holding B.V. nor its affiliates warrants or guarantees the contents and correctness of the provided information and data. Lumileds Holding B.V. and its affiliates reserve the right to make changes without notice. You as user agree to this disclaimer and user agreement with the download or use of the provided materials, information and data. A listing of Lumileds product/patent coverage may be accessed at lumileds.com/patents.

Looking for pricing, stock, or lifecycle information?

Click below to explore more details on WIN SOURCE:

 [View LXA7-PW57](#) on WIN SOURCE

 [Lumileds](#) Information

Optimize Your Supply Chain with WIN SOURCE Solutions

-  Global Sourcing Solution
-  Obsolete Management
-  Cost Control Management
-  Shortage Management
-  Alternative Solution
-  Excess Inventory Management