



**THE DATASHEET OF
CP12944_LARISA-W-CLIP8**



LARISA-W-CLIP8

~50° wide beam. Clip fastening for 0.8 mm thick PCB

SPECIFICATION:

Dimensions	9.9 x 9.9 mm
Height	7.5 mm
Fastening	glue, clips
ROHS compliant	yes ⓘ



MATERIALS:

Component	Type	Material	Colour	Finish	Length
LARISA-W	Single lens	PMMA	clear		8.9
LARISA-HOLDER-CLIP8	Holder	PC	black		9.9

ORDERING INFORMATION:

Component		Qty in box	MOQ	MPQ	Box weight (kg)
CP12944_LARISA-W-CLIP8	Single lens	10000	300	100	6.6
» Box size: 300 x 250 x 250 mm					

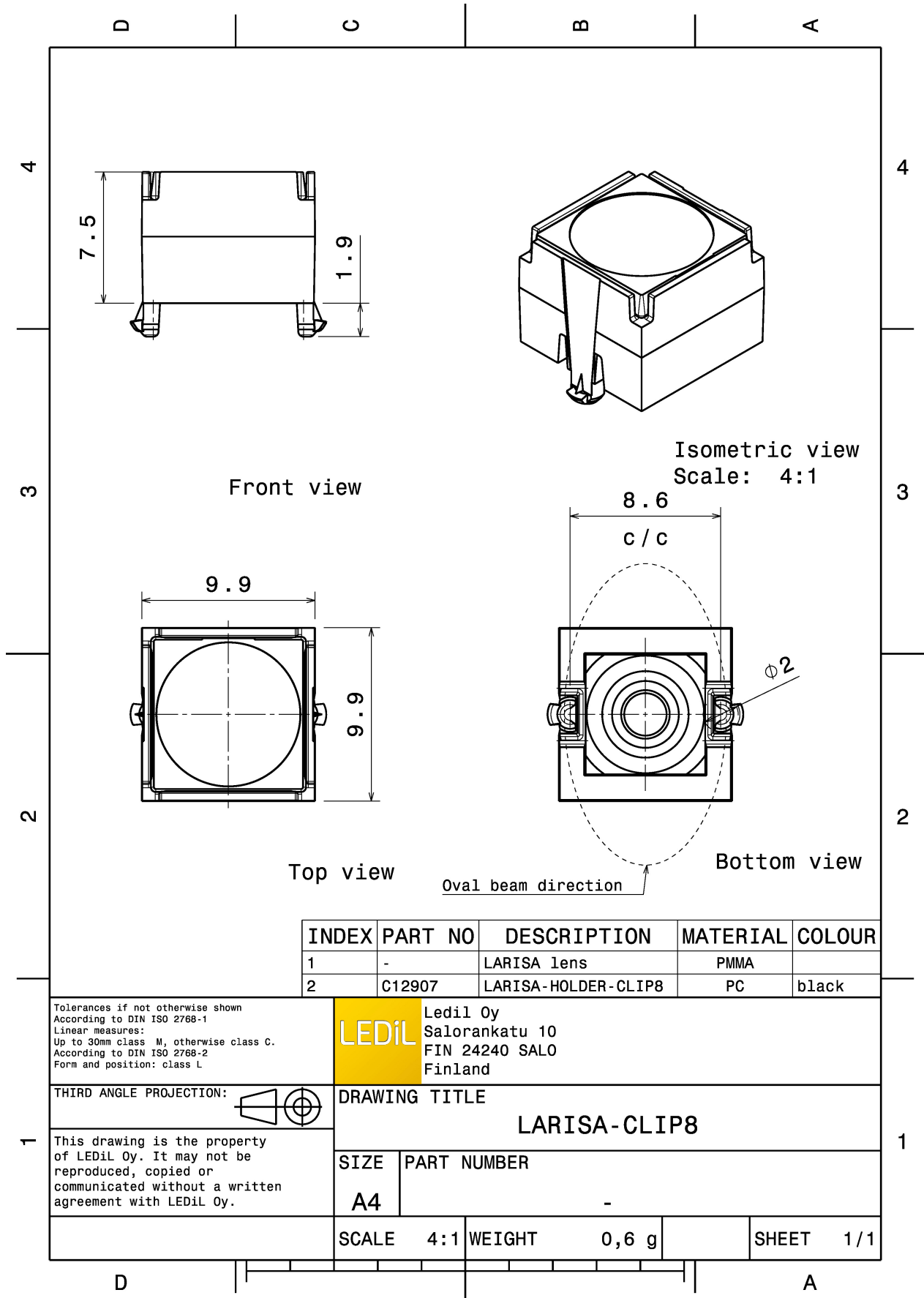

See also our general installation guide: www.ledil.com/installation_guide

OPTICAL RESULTS (MEASURED):



LED XB-D
FWHM / FWTM 45.0° / 78.0°
Efficiency 84 %
Peak intensity 1.3 cd/lm
LEDs/each optic 1
Light colour/type White
Required components:

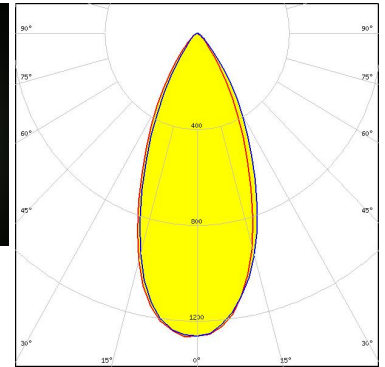
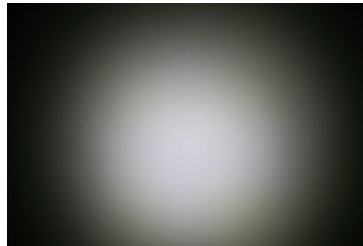

Light distribution files



LED XD16
FWHM / FWTM 56.0° / 86.0°
Efficiency 80 %
Peak intensity 0.9 cd/lm
LEDs/each optic 1
Light colour/type White
Required components:

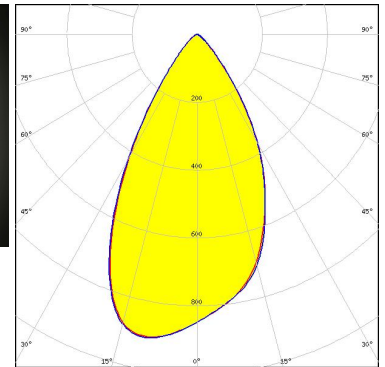
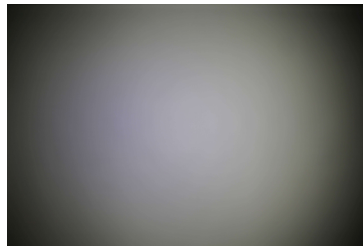

Light distribution files



LED XQ-E HD
FWHM / FWTM 46.0° / 80.0°
Efficiency 84 %
Peak intensity 1.2 cd/lm
LEDs/each optic 1
Light colour/type White
Required components:

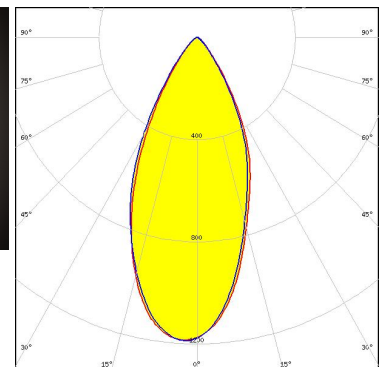
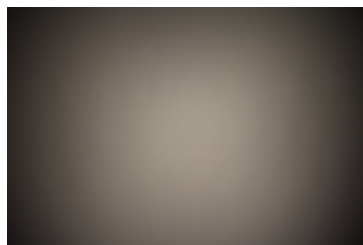

Light distribution files

OPTICAL RESULTS (MEASURED):



LED LUXEON A
FWHM / FWTM 63.0° / 91.0°
Efficiency 86 %
Peak intensity 0.8 cd/lm
LEDs/each optic 1
Light colour/type White
Required components:

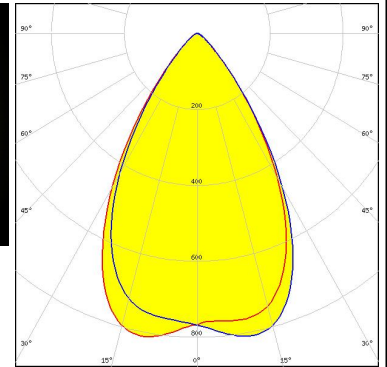
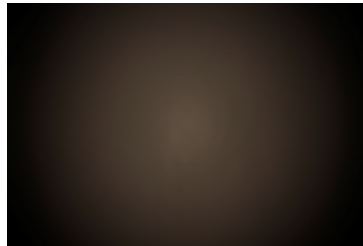

Light distribution files



LED LUXEON Rebel
FWHM / FWTM 47.0° / 78.0°
Efficiency 88 %
Peak intensity 1.3 cd/lm
LEDs/each optic 1
Light colour/type White
Required components:

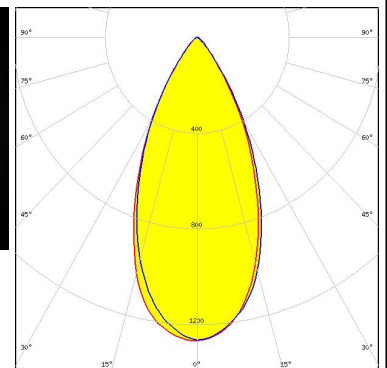
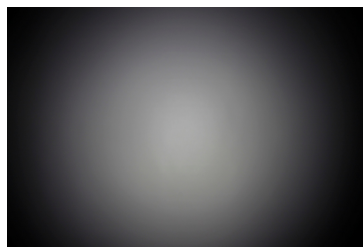

Light distribution files



LED LUXEON Rebel ES
FWHM / FWTM 52.0° / 85.0°
Efficiency 87 %
Peak intensity 1.1 cd/lm
LEDs/each optic 1
Light colour/type White
Required components:

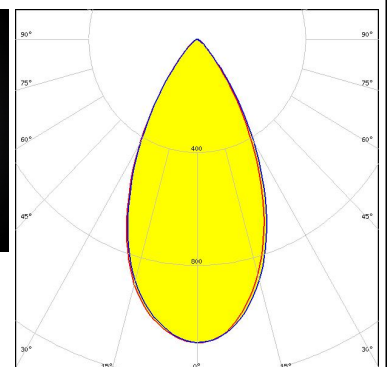
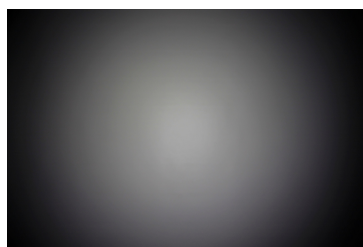

Light distribution files

OPTICAL RESULTS (MEASURED):



LED LUXEON Z
 FWHM / FWTM 32.0° / 68.0°
 Efficiency 85 %
 Peak intensity 2.1 cd/lm
 LEDs/each optic 1
 Light colour/type White
 Required components:

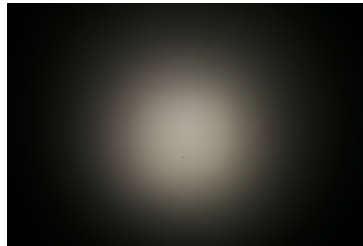

[Light distribution files](#)



LED LUXEON Z ES
 FWHM / FWTM 37.0° / 69.0°
 Efficiency 88 %
 Peak intensity 1.7 cd/lm
 LEDs/each optic 1
 Light colour/type White
 Required components:

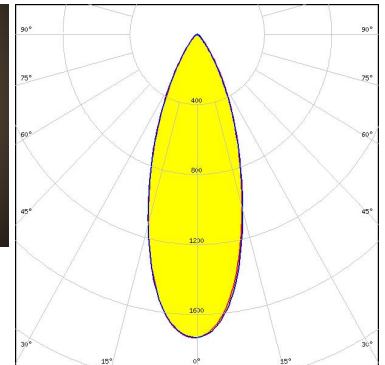
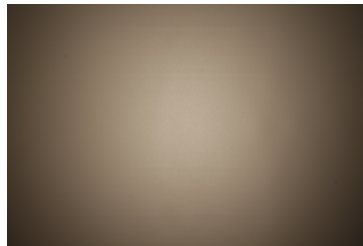

[Light distribution files](#)



LED NCSxx19A
 FWHM / FWTM 39.0° / 73.0°
 Efficiency 85 %
 Peak intensity 1.5 cd/lm
 LEDs/each optic 1
 Light colour/type White
 Required components:

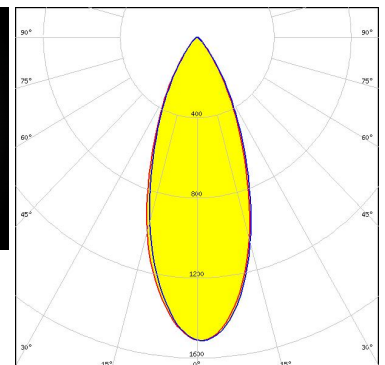
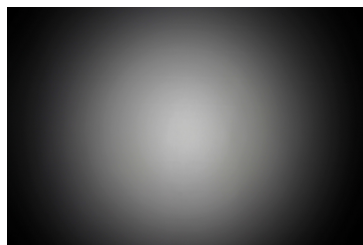

[Light distribution files](#)

OPTICAL RESULTS (MEASURED):



LED NF2x757A
FWHM / FWTM 37.0° / 72.0°
Efficiency 84 %
Peak intensity 1.7 cd/lm
LEDs/each optic 1
Light colour/type White
Required components:

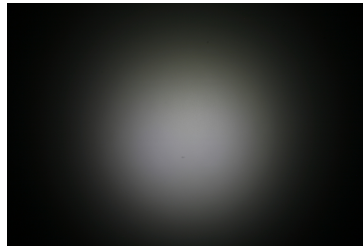

Light distribution files



LED NF2x757G
FWHM / FWTM 40.0° / 75.0°
Efficiency 83 %
Peak intensity 1.4 cd/lm
LEDs/each optic 1
Light colour/type White
Required components:

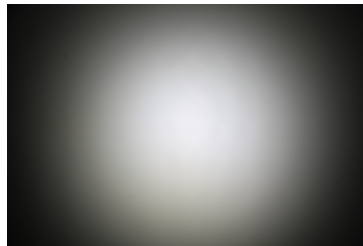

Light distribution files



LED NVSxx19A
FWHM / FWTM 45.0° / 80.0°
Efficiency 84 %
Peak intensity 1.2 cd/lm
LEDs/each optic 1
Light colour/type White
Required components:

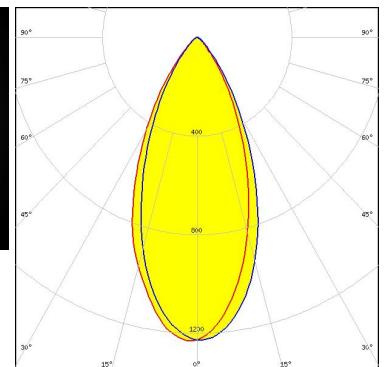
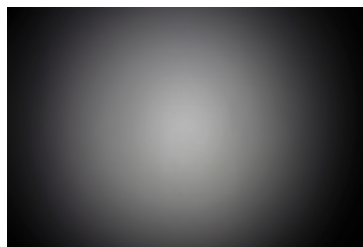

Light distribution files

OPTICAL RESULTS (MEASURED):

OSRAM
Opto Semiconductors

LED Duris S5 (2 chip)
FWHM / FWTM 41.0° / 76.0°
Efficiency 85 %
Peak intensity 1.5 cd/lm
LEDs/each optic 1
Light colour/type White
Required components:

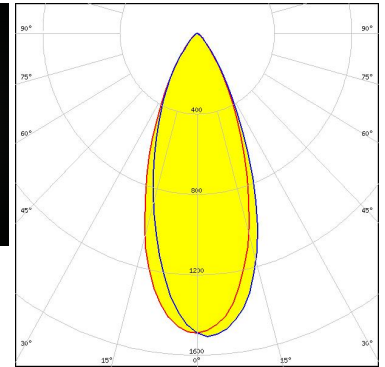
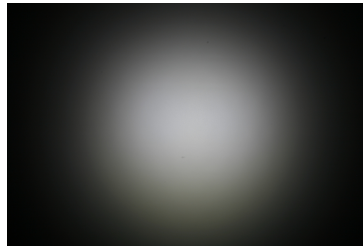

Light distribution files

OSRAM
Opto Semiconductors

LED OSLOM Square EC
FWHM / FWTM 46.0° / 83.0°
Efficiency 82 %
Peak intensity 1.1 cd/lm
LEDs/each optic 1
Light colour/type White
Required components:

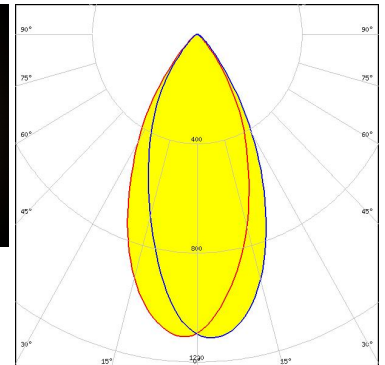
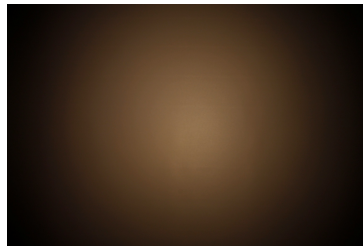

Light distribution files

OSRAM
Opto Semiconductors

LED OSLOM SSL 150
FWHM / FWTM 55.0° / 81.0°
Efficiency 86 %
Peak intensity 1.2 cd/lm
LEDs/each optic 1
Light colour/type White
Required components:

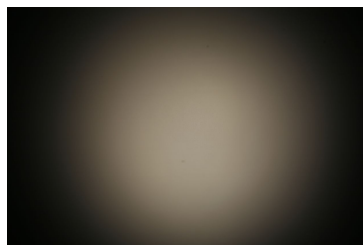

Light distribution files

OPTICAL RESULTS (SIMULATED):



LED XQ-E HI
FWHM / FWTM 47.0° / 73.0°
Efficiency 94 %
Peak intensity 1.5 cd/lm
LEDs/each optic 1
Light colour/type White
Required components:

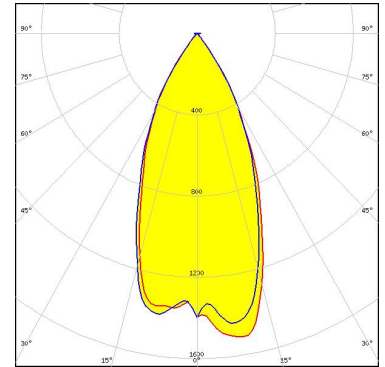

Light distribution files



LED NCSxE17A
FWHM / FWTM 30.0° / 60.0°
Efficiency 88 %
Peak intensity 2.5 cd/lm
LEDs/each optic 1
Light colour/type White
Required components:

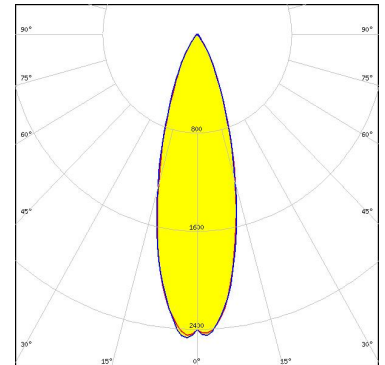

Light distribution files



LED OSOLON SSL 80
FWHM / FWTM 49.0° / 80.0°
Efficiency 83 %
Peak intensity 1.2 cd/lm
LEDs/each optic 1
Light colour/type White
Required components:

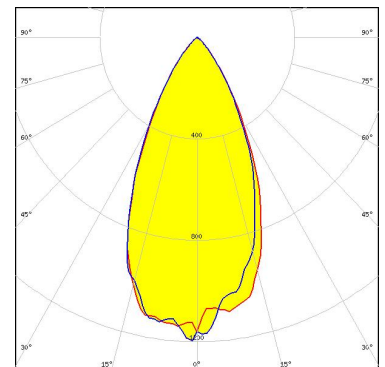

Light distribution files

GENERAL INFORMATION:

NOTE: The typical beam angle will be changed by different color, chip size and chip position tolerance. The typical total beam angle is the full angle measured where the luminous intensity is half of the peak value.

MATERIALS:

As part of our continuous research and improvement processes, and to ensure the best possible quality and availability of our products, LEDiL reserves the right to change material grades without notice.

PRODUCT DATA USER AGREEMENT AND DISCLAIMER:

The measured data in the provided downloadable LEDiL Product Datasheets and Mechanical 2D-Drawings is rounded and provided as reference for planning. LEDiL Oy's optical specifications have been verified by conducting performance testing of the products in accordance with the company's quality system. The reported data are averaged results of multiple measurements with typical variation. LEDiL Oy reserves the right to without prior notification make changes and improvements to its products.

LEDiL Oy assumes neither warranty, nor guarantee nor any other liability of any kind for the contents and correctness of the provided data. The provided data has been generated with highest diligence but the provided data may in reality not represent the complete possible variation range of all intrinsic parameters. Therefore, in certain cases a deviation from the provided data could occur.

LEDiL Oy reserves the right to undertake technical changes of its products without further notification which could lead to changes in the provided data. LEDiL Oy assumes no liability of any kind for the possible deviation from any provided data or any other damage resulting from the usage of the provided data.

The user agrees to this disclaimer and user agreement with the download or usage of the provided files.

LEDiL Oy

Joensuunkatu 13
FI-24240 SALO
Finland

LEDiL Inc.

228 West Page Street
Suite D
Sycamore IL 60178
USA

Ledil Optics Technology (Shenzhen) Co., Ltd.

405 , Block B
Casic Motor Building
Shenzhen 518057
P.R.CHINA

Local sales and technical support

[www.ledil.com/
where_to_buy](http://www.ledil.com/where_to_buy)

Shipping locations

Poznan, Poland
Hong Kong, China

Distribution Partners

[www.ledil.com/
where_to_buy](http://www.ledil.com/where_to_buy)

Looking for pricing, stock, or lifecycle information?

Click below to explore more details on WIN SOURCE:

-  [View CP12944_LARISA-W-CLIP8 on WIN SOURCE](#)
-  [Ledil Information](#)

Optimize Your Supply Chain with WIN SOURCE Solutions

-  Global Sourcing Solution
-  Obsolete Management
-  Cost Control Management
-  Shortage Management
-  Alternative Solution
-  Excess Inventory Management