



**THE DATASHEET OF  
TCU10204**



## MODEL TCU - TEMPERATURE CONTROL UNIT



- 100 msec SAMPLING PERIOD WITH 0.15% ACCURACY
- ON DEMAND AUTO-TUNING OF PID CONTROL SETTINGS
- DUAL LED DISPLAYS FOR SIMULTANEOUS INDICATION OF TEMPERATURE AND SETPOINT, SECOND ANALOG INPUT OR HEATER CURRENT
- ACCEPTS 10 DIFFERENT TYPES OF SENSOR INPUTS (Thermocouple or RTD)

- SELF-DIAGNOSTICS
- FULL PID CONTROL WITH REDUCED OVERSHOOT
- OPTIONAL RS485 SERIAL COMMUNICATIONS INTERFACE
- OPTIONAL DUAL ALARM OUTPUTS (USES OUTPUT MODULES)
- OPTIONAL COOLING OUTPUT (USES OUTPUT MODULE)
- OPTIONAL LINEAR 4 to 20 mA or 0 to 10 VDC OUTPUT FOR CONTROL OR TEMPERATURE RE-TRANSMISSION
- OPTIONAL HEATER CURRENT MONITOR AND BREAK ALARM
- OPTIONAL MOTORIZED VALVE POSITION CONTROL AND VALVE FAIL ALARM
- OPTIONAL SECOND ANALOG INPUT FOR REMOTE SETPOINT AND CASCADE CONTROL
- OPTIONAL TYPE 4X/IP65 SEALED FRONT BEZEL
- STATUS INDICATORS FOR OUTPUTS AND CONTROL MODES
- PROGRAMMABLE USER INPUT (DIGITAL) FOR ADDED FLEXIBILITY
- SENSOR ERROR COMPENSATION (Slope and Offset) AND BREAK DETECTION
- MANUAL/AUTOMATIC AND LOCAL/REMOTE SETPOINT CONTROL MODES
- SETPOINT RAMPING FOR PROCESS STARTUP
- PARAMETER SECURITY VIA PROGRAMMABLE LOCKOUTS
- FIELD REPLACEABLE AND INTERCHANGEABLE OUTPUT MODULES (Relay, Logic/SSR Drive and Triac)

### DESCRIPTION

The TCU Controller accepts signals from a variety of temperature sensors (*thermocouple or RTD elements*), precisely displays the process temperature, and provides an accurate output control signal (*time proportional or linear*) to maintain a process at the desired control point. A comprehensive set of easy to use steps allows the controller to solve various application requirements.

The controller can operate in the PID control mode for both heating and cooling, with on-demand auto-tune, which will establish the tuning constants. The PID tuning constants may be fine-tuned by the operator at any time and then locked out from further modification. The controller employs a unique overshoot suppression feature, which allows the quickest response without excessive overshoot. The unit can be transferred to operate in the manual mode, providing the operator with direct control of the output. The controller may also be programmed to operate in the ON/OFF control mode with adjustable hysteresis.

Dual 4-digit displays allow viewing of the process temperature and setpoint simultaneously. Front panel indicators inform the operator of the controller and output status. Replaceable and interchangeable output modules (*relay, SSR drive, or triac*) can be installed for the main control output, alarm output(s) and cooling output.

Optional dual alarms can be configured to activate according to a variety of actions (Absolute HI or LO, Deviation HI or LO, Band IN or OUT, Heater Break and Valve Fail Detect) with adjustable hysteresis. A standby feature suppresses the output during power-up until the temperature stabilizes outside the alarm region. An optional secondary output is available (*for processes that require cooling*) which provides increased control accuracy and response.

### DIMENSIONS In inches (mm)

Note: Recommended minimum clearance (behind the panel) for mounting clip installation is 5.5" (140) H x 2.1" (53.4) W.

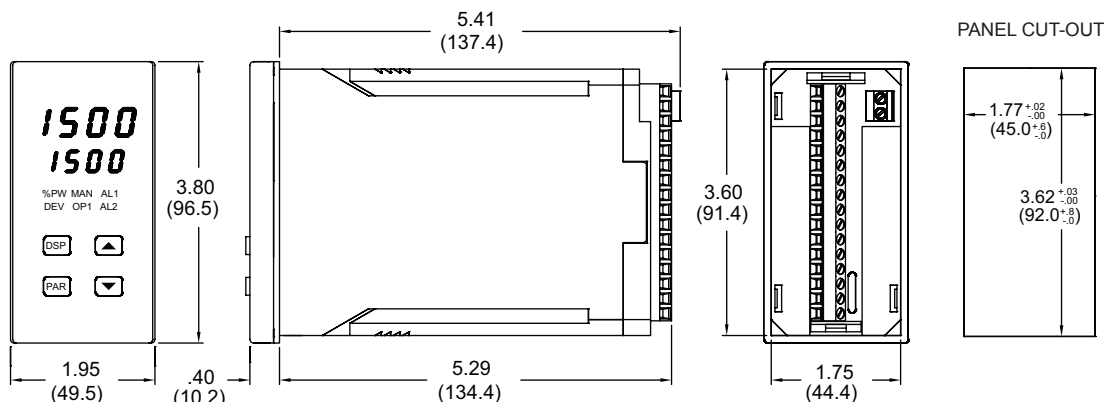

## DESCRIPTION (Cont'd)

### OPTIONS

A linear 4 to 20 mA or 0 to 10 VDC output signal is available to interface with actuators, chart recorders, indicators, or other controllers. The output signal can be digitally scaled and selected to transmit one of the following: % output power, process temperature value, process temperature value deviation or setpoint value. For Linear DC control applications, the adjustable output demand dampening, output deadband and output update time parameters expand the versatility of the TCU with final control devices.

The optional Heater Current Monitor serves as a digital ammeter for heater current monitoring. Current transformer accessory (CT005001), is required. An alarm event output can be programmed to signal when the heater or heater control devices have failed, before damage to process material occurs. The Heater Break alarm triggers under two conditions:

- 1) The main output (OP1) is "on" and the heater current is below the heater current alarm value, indicating an aged or failed heater.
- 2) Output (OP1) is "off" and the heater current is more than 10% of the alarm value, indicating a shorted heater control device or other problem.

The optional Motorized Valve Positioner directly controls the position of a valve by the use of twin outputs (*open and close*) to control the direction of motor rotation. The motor position defines the opening position of the valve. Two control modes are possible: position control, which makes use of the slidewire feedback signal supplied with the positioner and velocity control, in which no slidewire feedback signal is used. Parameters are provided to adjust the operation of the valve. These include:

- Valve activity hysteresis
- Valve update time
- Variable control dampening
- Slidewire signal fail action
- Adjustable valve position limits.

The valve positioner TCU achieves tight process control, yet minimizes unnecessary valve activity. An alarm event output or display alarm can be programmed under loss of slidewire feedback or under valve fail detection.

The optional Second Analog Input (0-20 mA DC) can be configured as a remote setpoint signal or as a secondary process signal. Configuration of the second analog input as a remote setpoint signal allows ratio control, master setpoint/multiple slave operation, and the ability to cascade the TCU with another controller (external cascade). Configuration of the second input as a secondary process signal allows operation as a two-process cascade controller within a single unit (internal cascade). In either control mode, parameters are provided to scale, configure, communicate and monitor the activity of both analog inputs. A square law linearizer function can be used to linearize signals derived from flow transmitters.

The optional RS485 multidrop serial communication interface provides two-way communication between a TCU unit and other compatible equipment such as a printer, a programmable controller, or a host computer. In multipoint applications the address number of each unit on the line can be programmed from 0-99. Up to thirty-two units can be installed on a single pair of wires. The Setpoint value, % Output Power, Setpoint Ramp Rate, etc. can be interrogated or changed by sending the proper command code via serial communications. Alarm output(s) may also be reset via the serial communications interface option.

An optional Type 4X/IP65 rated bezel is available for wash down and/or dirty environments, when properly installed. Modern surface-mount technology, extensive testing, plus high immunity to noise interference makes the controller extremely reliable in industrial environments.

## SAFETY SUMMARY

All safety related regulations, local codes and instructions that appear in the manual or on equipment must be observed to ensure personal safety and to prevent damage to either the instrument or equipment connected to it. If equipment is used in a manner not specified by the manufacturer, the protection provided by the equipment may be impaired.

Do not use the TCU to directly command motors, valves, or other actuators not equipped with safeguards. To do so, can be potentially harmful to persons or equipment in the event of a fault to the unit. An independent and redundant temperature limit indicator with alarm outputs is strongly recommended. The indicators should have input sensors and AC power feeds independent from other equipment.

## SPECIFICATIONS

### 1. DISPLAY: Dual 4-digit

**Upper Temperature Display:** 0.4" (10.2 mm) high red LED

**Lower Auxiliary Display:** 0.3" (7.6 mm) high green LED

**Display Messages (Model dependent):**

- "OLOL" - Appears when measurement exceeds + sensor range.
- "ULUL" - Appears when measurement exceeds - sensor range.
- "OPEN" - Appears when open sensor is detected.
- "SHrt" - Appears when shorted sensor is detected (*RTD only*)
- "..." - Appears when display values exceed + display range.
- "-..." - Appears when display values exceed - display range.

"SLid" - Appears when loss of slidewire signal is detected.

"VALV" - Appears when valve actuator error is detected.

2. **POWER:** Switch selectable for 115/230 VAC (+10%, -15%) no observable line variation effect, 48 to 62 Hz, 10 VA

### 3. ANNUNCIATORS:

**LED Backlight Status Indicators (Model dependent):**

%PW - Lower auxiliary display shows power output in (%).  
DEV - Lower auxiliary display shows deviation (*error*) from temperature setpoint.

OP1 - Main control output is active.

AL1 - Alarm #1 is active.

AL2 - Alarm #2 is active (*for Dual Alarm Option*).

OP2 - Cooling output is active (*for Cooling Option*).

OPN - Valve positioner OPEN output is active (*for Valve Positioner option*).

CLS - Valve positioner CLOSE output is active (*for Valve Positioner option*).

CUR - Lower auxiliary display shows heater current (*for Heater Current Monitor option*).

SEC - Lower auxiliary display shows second analog input (*For Second Analog Input option*).

MAN - Flashing: Controller is in manual mode.

REM - ON: controller is in remote setpoint mode (*Second Analog Input option*).

- OFF: controller is in local setpoint mode (*Second Analog Input option*).

- Flashing: controller is in Manual control mode (*Second Analog Input optional*).

4. **CONTROLS:** Four front panel push buttons for modifying and setup of controller functions and one external input for parameter lockout or other functions.

### 5. MAIN SENSOR INPUT:

**Sample Period:** 100 msec

**Response Time:** 300 msec (*to within 99% of final value w/step input; typically, response is limited to response time of probe*)

**Failed Sensor Response:**

**Main Control Output(s):** Programmable preset output

**Display:** "OPEN"

**Alarms:** Upscale drive

**DC Linear:** Programmable preset output

**Normal Mode Rejection:** 40 dB @ 50/60 Hz (*improves with increased digital filtering*).

**Common Mode Rejection:** 100 dB, DC to 60 Hz

**Protection:** Input overload 120 VAC for 30 seconds.

### 6. THERMOCOUPLE:

**Types:** T, E, J, K, R, S, B, N, Linear mV

**Input Impedance:** 20 M  $\Omega$  all types

**Lead resistance effect:** 20  $\mu$ V/350  $\Omega$

**Cold junction compensation:** Less than  $\pm 1^\circ$ C error over 0 - 50 $^\circ$ C ambient temperature range. Disabled for Linear mV type.

**Resolution:** 1 $^\circ$ C/F all types, or 0.1 $^\circ$ C/F for T, E, J, K, and N only.

7. **RTD:** 2, 3 or 4 wire, 100  $\Omega$  platinum, alpha = 0.00385 (DIN 43760), alpha = 0.003916

**Excitation:** 0.175 mA

**Resolution:** 1 or 0.1 degree

**Lead Resistance:** 7  $\Omega$  maximum

### 8. RANGE AND ACCURACY:

Errors include NIST conformity and A/D conversion errors at 23 $^\circ$ C after 20 min. warm-up. Thermocouple errors include cold junction effect. Errors are expressed as  $\pm$ percent of reading and  $\pm 3/4$  LSD unless otherwise noted.

TC TYPE	RANGE	ACCURACY	WIRE COLOR (ANSI)
T	-200 to +400 $^\circ$ C -328 to +752 $^\circ$ F	0.20% + 1.5 $^\circ$ C 0.20% + 2.7 $^\circ$ F	blue
E	-200 to 750 $^\circ$ C -328 to +1382 $^\circ$ F	0.20% + 1.5 $^\circ$ C 0.20% + 2.7 $^\circ$ F	violet
J	-200 to +760 $^\circ$ C -328 to +1400 $^\circ$ F	0.15% + 1.5 $^\circ$ C 0.15% + 2.7 $^\circ$ F	white
K	-200 to +1250 $^\circ$ C -328 to +2282 $^\circ$ F	0.20% + 1.5 $^\circ$ C 0.20% + 2.7 $^\circ$ F	yellow
R	0 to +1768 $^\circ$ C +32 to +3214 $^\circ$ F	0.15% + 2.5 $^\circ$ C 0.15% + 4.5 $^\circ$ F	black
S	0 to +1768 $^\circ$ C +32 to +3214 $^\circ$ F	0.15% + 2.5 $^\circ$ C 0.15% + 4.5 $^\circ$ F	black
B	+200 to +1820 $^\circ$ C +300 to +3308 $^\circ$ F	0.15% + 2.5 $^\circ$ C 0.15% + 4.5 $^\circ$ F	grey
N	-200 to +1300 $^\circ$ C -328 to +2372 $^\circ$ F	0.20% + 1.5 $^\circ$ C 0.20% + 2.5 $^\circ$ F	orange
mV	-5.00 to 56.00	0.15% + 1 LSD	—
RTD (385)	-200 to +600 $^\circ$ C -328 to +1100 $^\circ$ F	0.10% + 0.5 $^\circ$ C 0.10% + 0.9 $^\circ$ F	—
RTD (392)	-160 to +600 $^\circ$ C -256 to +1100 $^\circ$ F	0.10% + 0.5 $^\circ$ C 0.10% + 0.9 $^\circ$ F	—
OHMS	1.0 to 320.0	0.15% + 1 LSD	—

## 9. OUTPUT MODULES [Optional] (For All Output Channels):

### Relay:

**Type:** Form-C (*Form-A with some models. See Ordering Information.*)

**Rating:** 5 Amps @ 120/240 VAC or 28 VDC (*resistive load*), 1/8 HP @ 120 VAC (*inductive load*)

**Life Expectancy:** 100,000 cycles at max. load rating. (*Decreasing load and/or increasing cycle time, increases life expectancy.*)

**Logic/SSR Drive:** Can drive multiple SSR Power Units.

**Type:** Non-isolated switched DC, 12 VDC typical

**Drive:** 45 mA max.

### Triac:

**Type:** Isolated, Zero Crossing Detection

### Rating:

**Voltage:** 120/240 VAC

**Max. Load Current:** 1 Amp @ 35°C  
0.75 Amp @ 50°C

**Min. Load Current:** 10 mA max.

**Offstate Leakage Current:** 7mA max. @ 60 Hz

**Operating Frequency:** 20 to 400 Hz

**Protection:** Internal Transient Snubber, Fused

## 10. MAIN CONTROL OUTPUT (Heating or Cooling):

**Control:** PID or ON/OFF

**Output:** Time proportioning or linear DC

**Hardware:** Plug-in, replaceable output modules

**Cycle time:** Programmable

**Auto-tune:** When selected, sets proportional band, integral time, and derivative time values.

**Probe Break Action:** Programmable

## 11. COOLING OUTPUT (Optional):

**Control:** PID or ON/OFF

**Output:** Time proportioning or linear DC

**Hardware:** Plug-in, replaceable output modules

**Cycle time:** Programmable

**Proportional Gain Adjust:** Programmable

**Heat/Cool Deadband Overlap:** Programmable

## 12. LINEAR DC OUTPUT (Optional): With digital scale and offset, programmable deadband and update time.

### 4 to 20 mA:

**Resolution:** 1 part in 3500 typ.

**Accuracy:**  $\pm(0.1\% \text{ of reading} + 25 \mu\text{A})$

**Compliance:** 10 V (*500  $\Omega$  max. loop impedance*)

### 0 to 10 VDC:

**Resolution:** 1 part in 3500 typ.

**Accuracy:**  $\pm(0.1\% \text{ of reading} + 35 \text{ mV})$

**Min. Load Resistance:** 10 K $\Omega$  (*1 mA max.*)

**Source:** % output power, setpoint, deviation, or temperature (*Available for heat or cool, but not both.*)

## 13. HEATER CURRENT MONITOR (Optional):

**Type:** Single phase, full wave monitoring of load currents controlled by main output (OP1)

**Input:** 100 mA AC output from current transformer RLC part number CT005001 or any current transformer with 100 mA AC output

**Display Scale Range:** 1.0 to 999.9 amperes or 100.0%

**Input resistance:** 5  $\Omega$

**Accuracy:** 1% of full scale  $\pm 1$  LSD (10 to 100% of range)

**Frequency:** 50 to 400 Hz

**Alarm mode:** Dual acting; heater element fail detect and control device fail detect

**Overload:** 200 mA (*steady state*)

**Min. output “on” time for Heater break alarm detect:** 400 msec

## 14. MOTORIZED VALVE POSITIONER (Optional):

**Two Outputs:** Valve open and valve close or Linear DC (*optional*)

**Hardware:** Plug-in, replaceable output modules

**Three Inputs:** Slidewire feedback, signal fail detect (*Isolated from main input*)

**Slidewire Resistance:** 100 to 100 K $\Omega$

**Slidewire Exciting Voltage:** 0.9 VDC

**Slidewire Fail Action:** programmable

**Control Mode:** Position mode (*with slidewire*) and velocity mode (*w/o slidewire*).

**Control Deadband:** 1% to 25.0% (*position mode*)

0.1 to 25.0 seconds (*velocity mode*)

**Update Time:** 1 to 250 seconds

**Motor Time (open, close):** 1 to 9999 seconds

**Position Limits:** Adjustable 0.0 to 100.0% of valve stroke

**Valve Fail Time:** Off to 9999 seconds

**Alarm mode:** Dual acting; loss of slidewire feedback signal and valve fail detection

## 15. SECOND ANALOG INPUT:

**Range:** 0 to 20 mA (*Isolated from main input*)

**Overload:** 100 mA (*steady state*)

**Input Resistance:** 10  $\Omega$

**Voltage Drop (@ 20 mA):** 0.2 V

**Accuracy:** 0.15% of reading  $\pm 10 \mu\text{A} \pm 1$  LSD

**Scale Range:** -999 to 9999

## 16. SERIAL COMMUNICATION:

**Type:** RS485 Multi-point, Balanced Interface

### Communication Format:

**Baud Rate:** Programmable from 300 to 9600

**Parity:** Programmable for odd, even, or no parity

**Frame:** 1 start bit, 7 data bits, 1 or no parity bit, 1 stop bit

**Unit Address:** Programmable from 0 to 99, max. of 32 units per line

**Transmit Delay:** 100 msec min., 200 msec max.

**RS485 Common:** Isolated from signal input common

**Auto Print Time:** Off to 9999 seconds between print-outs

## 17. USER INPUT (Optional): Internally pulled up to +5 VDC.

$V_{IN\ MAX} = 5.25$  VDC,  $V_{IL} = 0.85 V_{MAX}$ ;  $V_{IH} = 3.0 V_{MIN}$ , Available on all second input (HCM, MVP & ANA) models, and on models with RS485.

**Response Time:** 100 msec max.

**Functions:** Program Lock

Integral Action Lock

Auto/Manual Mode Select

Setpoint Ramp Select

Reset Alarms

Print Request

Local/Remote Setpoint Select

## 18. ALARMS (Optional):

**Hardware:** Plug-in, replaceable output module

**Modes:** Absolute high acting

Absolute low acting

Deviation high acting

Deviation low acting

Inside band acting

Heater break

Valve fail

Second Analog Input monitoring

**Reset Action:** Programmable; automatic or latched

**Standby Mode:** Programmable; enable or disable

**Hysteresis:** Programmable

**Probe Break Action:** Upscale

**Annunciator:** LED backlight for “AL1”, “AL2”, (*Alarm #2 not available with cooling output or motorized valve position option.*)

## 19. ENVIRONMENTAL CONDITIONS:

**Operating Temperature Range:** 0 to 50°C

**Storage Temperature Range:** -40 to 80°C

**Vibration to IEC 68-2-6:** Operational 5-150 Hz, 1 g

**Shock to IEC 68-2-27:** Operational 5 g

**Span Drift (maximum):** 100 ppm/°C, main input; 150 ppm/°C, second input

**Operating and Storage Humidity:**

85% max. (non-condensing) from 0 to 50°C

**Zero Drift (maximum):** 1  $\mu\text{V}/^\circ\text{C}$ , main input; 2  $\mu\text{A}/^\circ\text{C}$ , second input

**Altitude:** Up to 2000 meters

## 20. ISOLATION BREAKDOWN RATINGS:

**All inputs and outputs with respect to AC line:** 2300 V

**Analog Outputs, Second Analog Input, Heater Current Input or**

**Slidewire Input with respect to main input:** 500 V

## 21. CERTIFICATIONS AND COMPLIANCES:

### CE Approved

EN 61326-1 Immunity to Industrial Locations

Emission CISPR 11 Class A

EN 61010-1

RoHS Compliant

UL Recognized Component: File #E156876

UL Listed: File #E137808

Type 2 Enclosure rating (Face only) for TCU0

Type 4X/IP65 Enclosure rating (Face only) for TCU1

*Refer to EMC Installation Guidelines section of the manual for additional information.*

## 22. CONNECTION: Jaw-type terminal block

**Wire Range:** 12-30 AWG copper wire

**Torque:** 5-7 inch-lbs (56-79 N-cm)

### 23. CONSTRUCTION:

**Front Panel:** Flame and scratch resistant tinted plastic

**Case:** High impact black plastic. (Mounting collar included)

**Type 4X/IP65 model only:** Sealed bezel utilizing two captive mounting screws (panel gasket included). This unit is rated for Type 4X/IP65 indoor use. Installation Category II, Pollution Degree 2

### 24. WEIGHT: 1.3 lbs (0.6 kgs)

### ACCESSORIES:

#### External SSR Power Unit:

**Switched Voltage Range:** 50 to 280 VAC (*Nominal: 240 VAC*)

**Load Current:** 45 Amps @ 25°C ambient temperature  
35 Amps @ 50°C ambient temperature

**On State Input:** 3 to 32 VDC @ 1500 Ω impedance. (*isolated*)  
(*Use Logic/SSR drive output module.*)

**Off State Input:** 0.0 to 1.0 VDC

**Size:** 5.5" (14 cm) L x 4.75" (12 cm) W x 2.62" (6.6 cm) H

#### Current Transformer:

**Current Ratio:** 50:0.1 (Amperes)

**Accuracy:** ±5.0%

**Operating Frequency:** 50 to 400 Hz

**Insulation Class:** 0.6 Kv BIL 10 Kv full wave

**Terminals:** Brass studs No. 8-36, (flat washer, washer, nut)

**Weight:** 8.0 oz (226 g)

**Approvals:** UL recognized component

## BASIC OPERATION

The TCU controls a process temperature by measuring the temperature via an input probe, then calculating a control output power value by use of a modified PID control algorithm. The unit controls the system with the new output power value to keep the process temperature at setpoint. The PID control algorithm incorporates features which provide for high control accuracy and low temperature overshoot from process disturbances.

## FRONT PANEL FEATURES

In the normal operating mode, the unit will display the process temperature in the upper display. One of six other parameters can be viewed in the lower display:

- Setpoint
- % Power Output
- Temperature Deviation
- Heater Current
- Second Input Process Value
- Temperature Symbol (F or C)

The six parameters can be scrolled through by pressing the DSP button. If enabled, the control setpoint or power output (manual mode only) can be directly modified in this mode.

In the normal operating mode, parameters are selected by use of the PAR button and modified by use of the UP and DOWN buttons. Parameters are then entered by the PAR button, which advances the user to the next parameter. Pressing the DSP button immediately returns the controller to the normal operating mode when making a parameter change. The controller's configuration and parameter settings are stored in an internal E<sup>2</sup>PROM device.

## HARDWARE FEATURES

The fast 100 msec input sampling rate provides quick controller response to a process disturbance, thus providing excellent temperature control. Measurement accuracy of 0.15% or better, provides closer process control conforming to the desired control setpoint value. One model accepts a variety of both thermocouple or RTD temperature probes. The AC input power is switch selectable, allowing the unit to operate from either 115 VAC or 230 VAC. Since the controller is serviceable from the front of the panel, the output modules may be easily changed or replaced without disturbing the wiring behind the panel. No re-programming is required when changing or replacing modules.

The optional Type 4X/IP65 rated model utilizes two bezel securing screws and a neoprene gasket to guarantee a water tight seal, when properly installed. The standard model simply requires pressing a latch to remove the unit.

Low-drift, highly stable circuitry ensures years of reliable and accurate temperature control. The recommended two-year re-calibration interval is easily accomplished via the programming menu.

## SETPOINT FEATURES

The controller setpoint can be protected from out of range values by programming the setpoint range limit values. Additionally, safeguards from inadvertent data entry can be programmed.

The setpoint ramp feature ramps the setpoint value at start-up or any time a setpoint change is made, at a user programmable rate. This feature reduces thermal shock to the process and helps to minimize temperature overshoot. The setpoint may also be transmitted by the optional linear DC output for slave control loops.

The second analog input may be configured as a remote setpoint. As such, the controller is easily switched from local/remote setpoint operation via the front panel or user input. Ratio and bias parameters provide on-line scaling of the remote setpoint. Absolute limit values and maximum rate of change of the remote setpoint further enhance controller flexibility.

## INPUT FEATURES

A programmable input filter can be used to stabilize readings from a process with varying or oscillating temperature characteristics, helping to provide better temperature control. A programmable temperature shift and slope function can be used to compensate for probe errors or to have multiple TCU units indicate the same nominal temperature.

The programmable User Input can be used to control a variety of functions, such as auto/manual transfer of the controller, reset alarm output(s), etc.

The second analog input has independent scaling parameters to match the units of other processes or transmitters, or to match the controller's range.

## OUTPUT FEATURES

Programmable output power limits provide protection for processes where excessive power can cause damage. Automatic sensor probe break detection, for fail-safe operation, causes the controller to default to a programmed output power (upscale or downscale burnout). With adjustable time proportioning-cycle time, and programmable DC linear output, the controller can satisfy a wide variety of output requirements.

Programmable dampening output hysteresis and output update time parameters can dramatically reduce actuator activity without degrading control accuracy.

The RS485 Communication option allows the user to access various controller parameters such as the setpoint, % output power, % proportional band, etc. The controller may be setup to transmit various parameters at a programmable automatic print rate.

## AUTO-TUNE

The TCU has an auto-tune feature which, on demand, automatically determines the PID control parameters for a particular thermal process. After completion of auto-tune, the PID parameters are automatically optimized for that process and loaded into nonvolatile memory. The operator may view and modify the parameters as desired.

Auto-tune may be invoked either at start-up or at setpoint, depending on the process requirements. An auto-tune programmable dampening factor produces various levels of process control and response characteristics.

## OPTIONS HEATING AND COOLING CONTROL

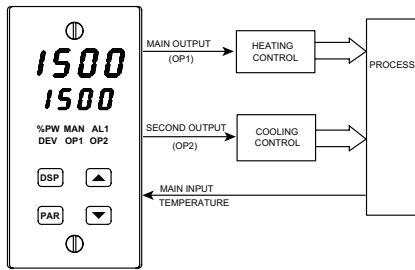

The TCU has dual outputs for providing heating and cooling to those processes that require them. Many extruder applications require both heating and cooling to maintain accurate extruder barrel and die temperatures. The TCU is easily configured for these applications.

### Cooling Configuration Parameters

- "CYC2" - Enter cooling time proportioning cycle time
- "GAN2" - Enter cooling relative gain
- "db-2" - Enter heat/cool deadband or overlap

## HEATER CURRENT MONITOR

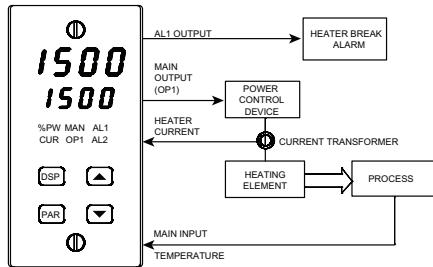

The Heater Current Monitor serves as a heater element fail sentry, so operators can take corrective action before significant process errors occur in the event of a failure. The actual heater current can be viewed in the secondary display and/or a heater break alarm output can be programmed.

### Heater Current Monitor Configuration Parameters

- "HCur" - Enter full scale current of current transformer
- ACT1", "ACT2" - Program alarm(s) as heater break alarm

## MOTORIZED VALVE POSITIONER

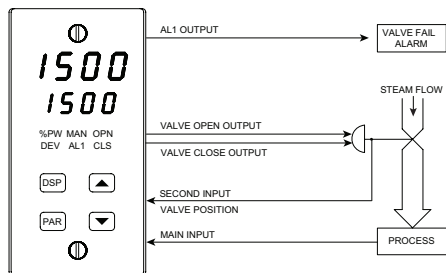

The motorized valve positioner controls the position of a valve directly, by use of "open" and "close" control outputs. The slidewire feedback signals of the valve may optionally be connected to the controller. Alternatively, the controller may be configured for linear input valve control using the 4 to 20 mA DC output.

### Motorized Valve Positioner Configuration Parameters

- Position mode:
  - "VPS1" - Enter or measure valve closed position
  - "VPS2" - Enter or measure valve open position
  - "VUdt" - Enter Valve update time
  - "VPdb" - Enter valve control deadband
  - "VFAL" - Enter valve fail detect time
  - "Act1" - Program alarm as valve fail output
- Velocity mode:
  - "VUdt" - Enter Valve update time
  - "VOpt" - Enter valve open time
  - "VCLt" - Enter valve close time
  - "VONT" - Enter valve control deadband (minimum on time)

## INTERNAL CASCADE

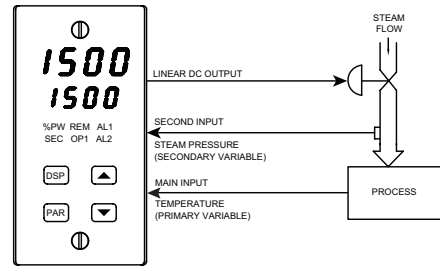

Cascade control allows the process to be divided into two control loops: the primary control loop and the secondary control loop. The secondary loop receives its setpoint from the primary loop to control an intermediate variable (steam pressure). The control level of the intermediate variable is the input to the primary process. The primary loop (temperature) controller maintains loop regulation by manipulating the setpoint of the secondary controller. The setpoint of the secondary controller, in turn, changes the intermediate variable. The secondary loop can react faster to disturbances of the intermediate variable, thereby minimizing the effects to the primary control loop. Control loops cascaded in such a manner provide greater control quality than would be possible with single loop control. A single TCU can accomplish two-process cascade control.

### Internal Cascade Configuration Parameters

- "OPer" - Select cascade mode
- "root" - Select second input square root linearization
- "dPt2" - Select second input decimal point
- "dSP1" - Enter scaling units of second input
- "INP1" - Enter scaling units of second input
- "dSP2" - Enter scaling units of second input
- "INP2" - Enter scaling units of second input
- "OPd2" - Output dampening of secondary

### Internal Cascade Operational Parameters

- "SP-2" - View secondary setpoint value
- "Pb-2" - Enter secondary proportional band
- "It-2" - Enter secondary integral time
- "dt-2" - Enter secondary derivative time

## EXTERNAL CASCADE

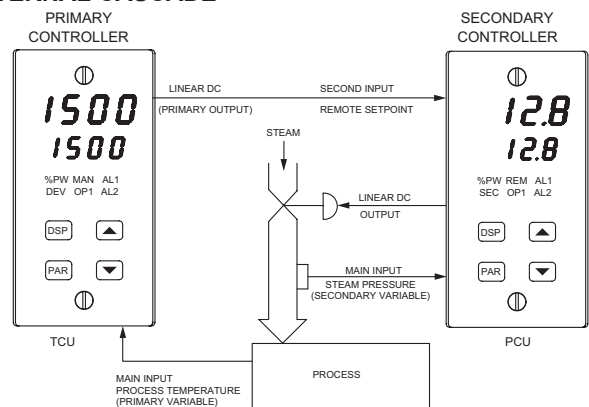

Similar to internal cascade control, external cascade control differs by the employment of two controllers, one of which is equipped with a second analog input configured as a remote setpoint. A PCU controls the secondary loop, while a TCU controls the primary loop.

### External Cascade Configuration Parameters

- "OPer" - Select ratio mode
- "root" - Select second input square root linearization
- "dPt2" - Select second input decimal point
- "dSP1" - Enter scaling units of second input
- "INP1" - Enter scaling units of second input
- "dSP2" - Enter scaling units of second input
- "INP2" - Enter scaling units of second input
- "SPtr" - Local/Remote select options

### External Cascade Operational Parameters

- "rtio" - Remote setpoint ratio
- "bIAS" - Remote setpoint bias

## SETPOINT MASTER CONTROL

Setpoint Master Control allows automatic setpoint changes to slave controller units (up to 50 units total) from a master TCU controller. The linear DC output of the master is looped with the second analog input of the slave TCU controllers. Each slave unit can have unique remote setpoint ratio and bias values.

### Setpoint Slave Configuration Parameters

- "OPE" - Select remote setpoint mode
- "root" - Select second input square root Linearization
- "dPI2" - Select second input decimal point
- "dSP1" - Enter scaling units of second input
- "INP1" - Enter scaling units of second input
- "dSP2" - Enter scaling units of second input
- "INP2" - Enter scaling units of second input
- "SPLO" - Limit range of remote setpoint
- "SPHI" - Limit rate of change of remote setpoint

### Setpoint Slave Operational Parameters

- "rtio" - Second input ratio
- "BIAS" - Second input bias

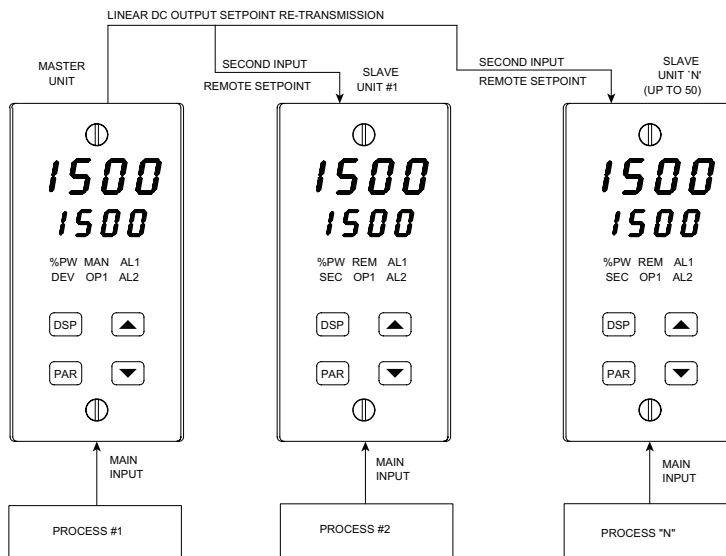

## CONTROLLER PROGRAMMING

The TCU has been designed to reduce the operator interaction with the controller while still maintaining a high degree of control accuracy and user flexibility. Front Panel Program Disable allows all of the controller's set-ups to be locked-out from further operator intervention after the initial parameter set-up.

The programming of the controller is divided into four sections:

- Unprotected Parameter Mode
- Configuration Parameter Mode
- Protected Parameter Mode
- Hidden Function Mode

These four programming modes allow the controller to adapt to any required user-interface level.

### UNPROTECTED PARAMETER MODE \*

The unprotected parameter mode is accessible when program disable is inactive or when the proper access code number from the protected mode is entered. The configuration parameter modes can be accessed only from this mode.

- "SP" - Enter Setpoint
- "OP" - Enter output power
- "ProP" - Enter proportional band
- "Intt" - Enter integral time
- "dErt" - Enter derivative time
- "rtio" - Enter Remote Setpoint ratio value
- "BIAS" - Enter Remote Setpoint bias value
- "SP-2" - View internal cascade secondary setpoint demand
- "Pb-2" - Enter internal cascade, secondary proportional band
- "It-2" - Enter internal cascade, secondary integral time
- "dt-2" - Enter internal cascade, secondary derivative time
- "AL-1" - Enter value for alarm #1
- "AL-2" - Enter value for alarm #2
- "CNFP" - Select basic configuration mode
- "End" - Return to normal display mode

\* These parameters may not appear due to option configuration or other programming.

### CONFIGURATION PARAMETER MODE

The configuration parameter mode allows the operator to set-up the basic requirements of the controller. It is divided into sections which group together related programming steps, such as inputs, outputs, alarms, etc. Upon completion of each section, the program returns to the configuration selection stage allowing the user to return to the normal display mode.

### Configuration 1, Inputs

- "tYPE" - Select input probe type
- "SCAL" - Select temperature scale
- "dCpt" - Select temperature resolution
- "FLtr" - Select level of input filtering
- "SPAN" - Enter input correction span (slope)
- "SHft" - Enter input correction shift (offset)
- "SPLO" - Enter setpoint lower limit
- "SPHI" - Enter setpoint higher limit
- "SPrP" - Enter setpoint ramp rate
- "InPt" - Select user input function \*
- "HCur" - Enter full scale heater current \*

### Configuration 2, Outputs

- "CYCt" - Enter time proportioning cycle time
- "OPAC" - Select control action
- "OPLO" - Enter output power low limit
- "OPHI" - Enter output power high limit
- "OPFL" - Enter probe fail power preset
- "OPdP" - Enter output control dampening
- "CHYS" - Enter ON/OFF control hysteresis
- "tcod" - Select auto-tuning dampening
- "ANAS" - Select linear DC output assignment \*
- "ANLO" - Enter linear DC output low scaling value \*
- "ANHl" - Enter linear DC output high scaling value \*
- "ANdb" - Enter linear DC output control deadband \*
- "ANUt" - Enter linear DC output update time \*

### Configuration 3, Parameter lock-outs

- "SP" - Select degree of setpoint access
- "OP" - Select degree of power access
- "dEv" - Enable deviation display \*
- "IN-2" - Enable second input display \*
- "HCur" - Enable heater current display
- "UdSP" - Enable temperature scale display
- "CodE" - Enter parameter access code
- "PId" - Select degree of PID access
- "PId2" - Select degree of secondary PID access \*
- "rtbS" - Select degree of ratio/bias access \*
- "AL" - Select degree of alarm access \*
- "ALrS" - Enable alarm reset access \*
- "SPSL" - Enable local/remote setpoint selection \*
- "trnF" - Enable auto/manual mode selection
- "tUNE" - Enable auto-tune invocation

### Configuration 4, Alarms \*

- "Act1" - Select operation mode of alarm #1
- "rSt1" - Select reset mode of alarm #1
- "Stb1" - Enable activation delay of alarm #1
- "AL-1" - Enter value for alarm #1
- "Act2" - Select operation mode of alarm #2
- "rSt2" - Select reset mode of alarm #2
- "Stb2" - Enable activation delay of alarm #2
- "AL-2" - Enter value for alarm #2
- "AHYS" - Enter hysteresis value for both alarms

### Configuration 5, Cooling \*

- "CYC2" - Enter cooling time proportioning cycle time
- "GAN2" - Enter cooling relative gain
- "db-2" - Enter heat/cool deadband or overlap

**Configuration 6, Serial Communications \***

- "bAUd" - Select baud rate
- "PArb" - Select parity bit
- "Addr" - Enter unit address number
- "Abrv" - Select abbreviated or full mnemonic transmissions
- "PrAt" - Enter automatic print rate
- "PoPt" - Select parameters to be included in print-out

**Configuration 7, Second Input \***

- "OPEr" - Select remote setpoint or internal cascade mode
- "root" - Select second input square root linearization
- "dPT2" - Select second input decimal point
- "dSP1" - Enter scaling parameters of second input
- "INP1" - Enter scaling parameters of second input
- "dSP2" - Enter scaling parameters of second input
- "INP2" - Enter scaling parameters of second input
- "SPt" - Enter local/remote select options
- "OPd2" - Enter Secondary output control dampening

**Configuration 8, Motorized Valve Positioner \***

- Position mode:
- "VPS1" - Enter or measure valve closed position
  - "VPS2" - Enter or measure valve open position
  - "VUdt" - Enter valve update time
  - "VPdb" - Enter valve control deadband
  - "VFAL" - Enter valve fail detect time
- Velocity mode:
- "VUdt" - Enter valve update time
  - "VOPT" - Enter valve open time
  - "VCLT" - Enter valve close time
  - "VONT" - Enter valve control deadband (minimum on time)

**HIDDEN FUNCTION MODE \***

The hidden function mode is accessible from the normal operating mode. The four functions in this mode may be locked-out individually in configuration 3 parameter lock-out section.

- "SPSL" - Select Local/Remote Setpoint
- "trnF" - Transfer between automatic (PID) control and manual control
- "tUNE" - Invoke/cancel PID Auto-tune
- "ALrS" - Reset latched alarms

**PROTECTED PARAMETERS MODE \***

The protected parameters mode is enabled when program disable is active. This mode prevents access to the configuration modes without the proper access code number. Only the parameters that are selected in the configuration 3 parameter lock-out section can be accessed.

- "ProP" - Enter Proportional band
- "Intt" - Enter integral time
- "dErT" - Enter derivative time
- "rtio" - Enter remote setpoint ratio value
- "bIAS" - Enter remote setpoint bias value
- "SP-2" - Enter internal cascade, secondary setpoint
- "Pb-2" - Enter internal cascade, secondary proportional band
- "It-2" - Enter internal cascade, secondary integral time
- "dt-2" - Enter internal cascade, secondary derivative time
- "AL-1" - Enter value for alarm #1
- "AL-2" - Enter value for alarm #2
- "CodE" - Enter access value to unprotected parameters & configuration parameters

\* These parameters may not appear due to option configuration or other programming.

**ACCESSORY - EXTERNAL RLY50000 SSR POWER UNIT SHOWN**  
(External DIN Rail mount SSR power units available)

The external SSR Power Unit is used with the Logic/SSR Drive Module (OMD00003) to switch loads up to 240 VAC @ 45 amps, 25°C ambient. The unit is operated by applying a low level DC control signal to the isolated input. The unit features zero cross detection circuits which reduces radiated RFI when switching load currents. With no contacts to wear out, the SSR Power Unit provides virtually limitless operational life. The unit is supplied with an integral heat sink for immediate installation.

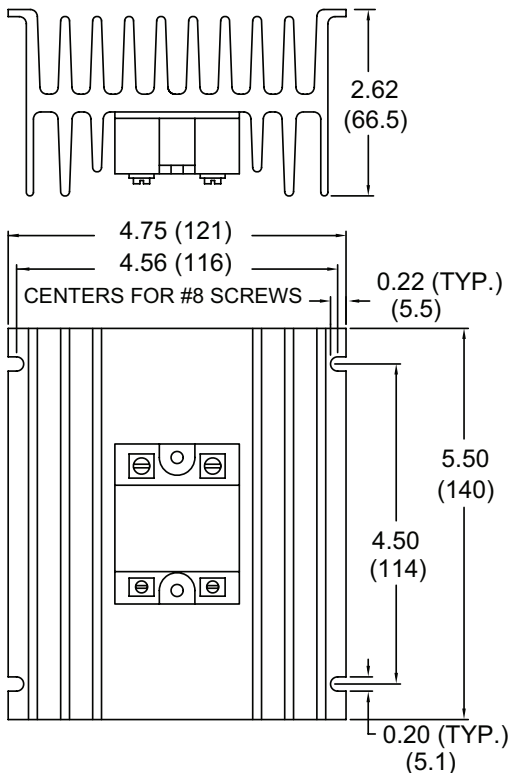

**ACCESSORY - CT005001 CURRENT TRANSFORMER SHOWN**  
(Lower current CT available)

The external Current Transformer is used when specifying TCUs equipped with the Heater Current Monitor. The primary current rating is 50 amperes.

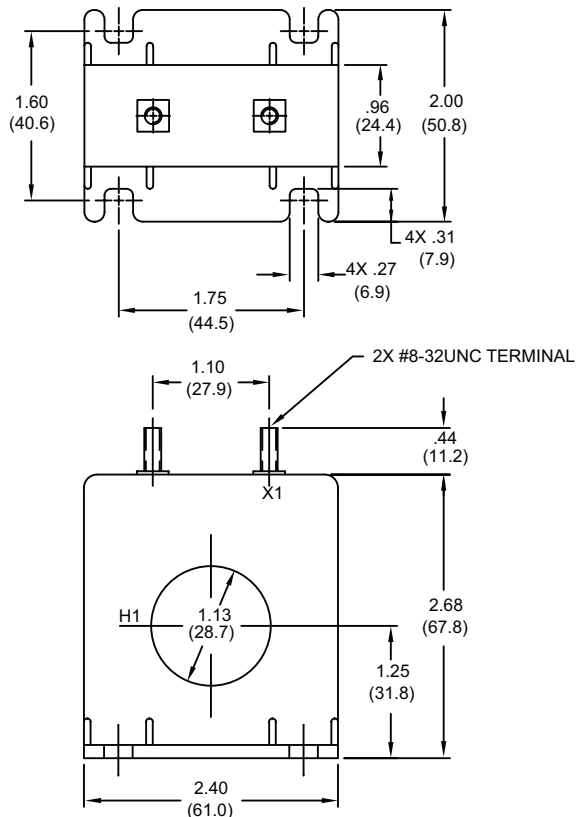

# OUTPUT MODULES

## TYPICAL CONNECTIONS

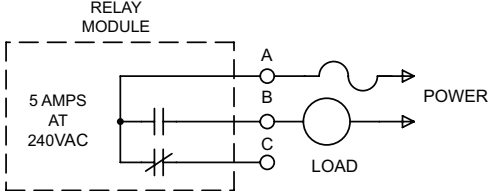

**Relay:**  
**Type:** Form-C (Form-A with some models. See ordering information.)  
**Rating:** 5 amps @ 120/240 VAC or 28 VDC (resistive load), 1/8 HP @ 120 VAC (inductive).  
**Life Expectancy:** 100,000 cycles at maximum load rating.

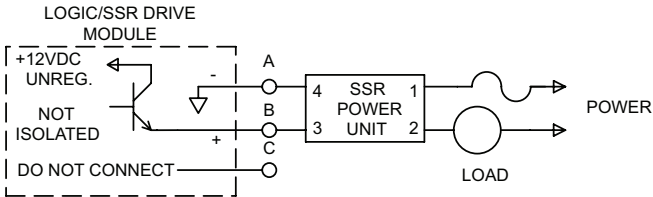

(Decreasing load and/or increasing cycle time, increases life expectancy).  
**Logic/SSR Drive:** Can drive multiple SSR Power Units.  
**Type:** Non-isolated switched DC, 12 VDC typical

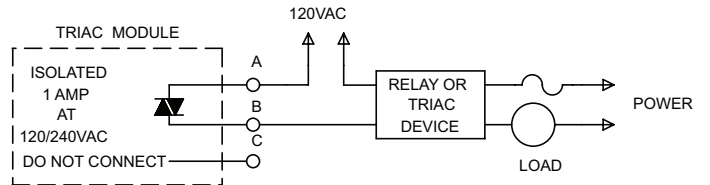

**Drive:** 45 mA maximum.  
**Triac:**  
**Type:** Isolated, Zero Crossing Detection  
**Rating:**  
**Voltage:** 120/240 VAC  
**Max. Load Current:** 1 ampere @ 35°C  
 0.75 ampere @ 50°C  
**Min. Load Current:** 10 mA  
**Off State Leakage Current:** 7 mA max. @ 60 Hz  
**Operating Frequency:** 20 to 400 Hz  
**Protection:** Internal Transient Snubber, Fused

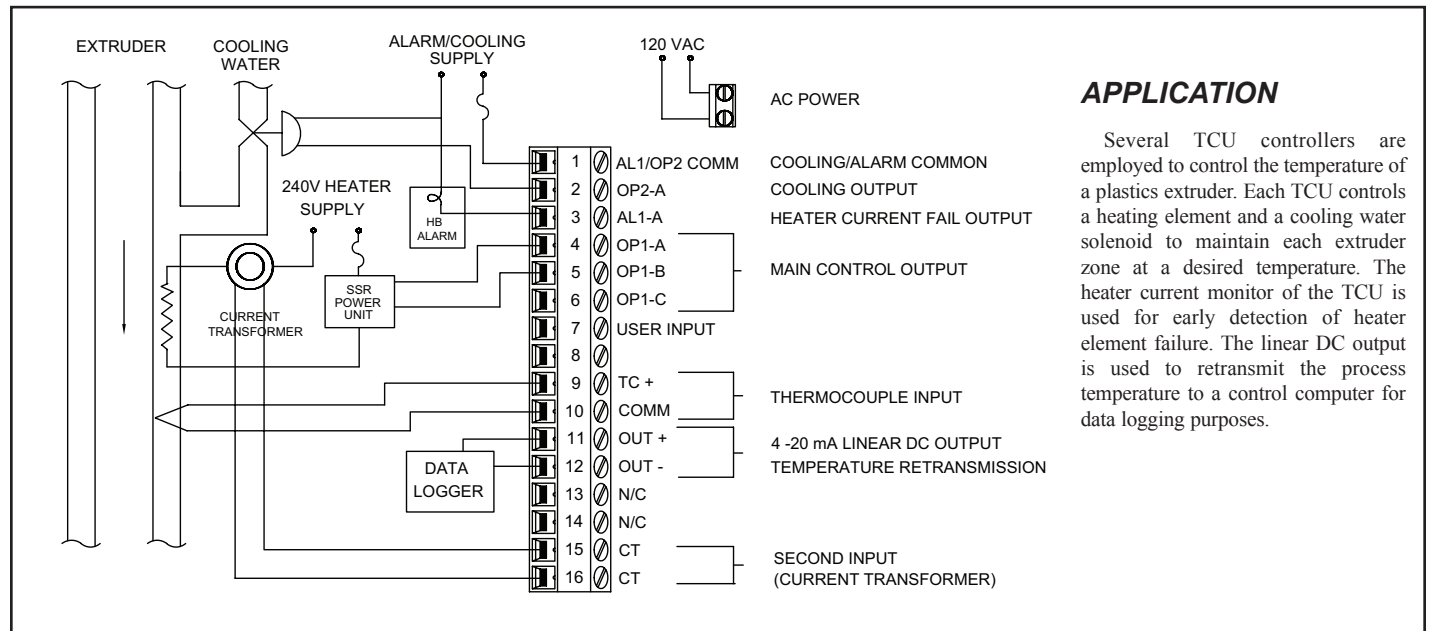

## APPLICATION

Several TCU controllers are employed to control the temperature of a plastics extruder. Each TCU controls a heating element and a cooling water solenoid to maintain each extruder zone at a desired temperature. The heater current monitor of the TCU is used for early detection of heater element failure. The linear DC output is used to retransmit the process temperature to a control computer for data logging purposes.

## ORDERING INFORMATION

### MODELS WITHOUT SECOND INPUT OPTIONS

Type 4X/IP65 BEZEL	4 to 20 mA ANALOG OUTPUT	0 to 10 VDC ANALOG OUTPUT	ALARM OUTPUTS	COOLING OUTPUT	RS485 COM	PART NUMBER 115/230 VAC
NO	NO	NO	NO	NO	NO	TCU00000
NO	NO	NO	2	NO	NO	TCU00001
NO	NO	NO	1	YES	NO	TCU00002
NO	YES	NO	2	NO	NO	TCU01001
NO	YES	NO	2	NO	YES	TCU01004
NO	YES	NO	1	YES	YES	TCU01005
YES	NO	NO	NO	NO	NO	TCU10000
YES	NO	NO	2	NO	NO	TCU10001
YES	NO	NO	1	YES	NO	TCU10002
YES	YES	NO	2	NO	NO	TCU11001
YES	YES	NO	1	YES	NO	TCU11002
YES	YES	NO	2	NO	YES	TCU11004
YES	YES	NO	1	YES	YES	TCU11005
YES	NO	YES	2	NO	NO	TCU12001
YES	NO	YES	2	NO	YES	TCU12004
YES	NO	YES	1	YES	YES	TCU12005

These models have dual alarm outputs, or single alarm with cooling outputs, with shared common terminals (Form A Type). As a result, these outputs should be fitted with the same type of output module. The main output (OP1) may be fitted with any type of output module.

### HEATER CURRENT MONITOR MODELS (HCM)

Type 4X/IP65 BEZEL	4 to 20 mA ANALOG OUTPUT	0 to 10 VDC ANALOG OUTPUT	ALARM OUTPUTS	COOLING OUTPUT	RS485 COM	PART NUMBER
YES	NO	NO	2	NO	YES	TCU10204
YES	YES	NO	2	NO	NO	TCU11208

These models have dual alarm outputs, or single alarm with cooling outputs, with shared common terminals (Form A Type). As a result, these outputs should be fitted with the same type of output module. The main output (OP1) may be fitted with any type of output module.

### SECOND ANALOG INPUT MODELS (ANA)

Type 4X/IP65 BEZEL	4 to 20 mA ANALOG OUTPUT	0 to 10 VDC ANALOG OUTPUT	ALARM OUTPUTS	COOLING OUTPUT	RS485 COM	PART NUMBER
YES	NO	NO	2	NO	YES	TCU10104
YES	YES	NO	2	NO	NO	TCU11108
YES	NO	YES	2	NO	NO	TCU12108

These models have dual alarm outputs, or single alarm with cooling outputs, with shared common terminals (Form A Type). As a result, these outputs should be fitted with the same type of output module. The main output (OP1) may be fitted with any type of output module.

### MOTORIZED VALVE POSITIONER MODELS (MVP)

Type 4X/IP65 BEZEL	4 to 20 mA ANALOG OUTPUT	0 to 10 VDC ANALOG OUTPUT	ALARM OUTPUTS	COOLING OUTPUT	RS485 COM	PART NUMBER
YES	NO	NO	1	NO	YES	TCU10307
YES	YES	NO	1	NO	NO	TCU11306
YES	NO	YES	1	NO	NO	TCU12306

### ACCESSORIES

DESCRIPTION	PART NUMBER
Relay Module	OMD00000
Triac Module	OMD00001
Logic/SSR Drive Module	OMD00003
45 A Single Phase Panel Mount SSR	RLY50000
25 A Single Phase DIN Rail Mount SSR	RLY60000
40 A Single Phase DIN Rail Mount SSR	RLY6A000
25 A Three Phase DIN Rail Mount SSR	RLY70000
50:0.1 Ampere Current Transformer	CT005001
40:0.1 Ampere Current Transformer	CT004001

Note: Output Modules are NOT supplied with the controller. When specifying the controller, be sure to purchase the appropriate output module for the Main Control Output and if necessary, the alarm output(s), the cooling output, and valve positioner outputs. The controller can be fitted with any combination of output modules.

The Logic/SSR Drive Module is a switched DC source, intended to drive the DC input of an SSR power unit. It should never be connected to line voltage.

All output modules are packaged separately and must be installed by the user.

### **LIMITED WARRANTY**

The Company warrants the products it manufactures against defects in materials and workmanship for a period limited to two years from the date of shipment, provided the products have been stored, handled, installed, and used under proper conditions. The Company's liability under this limited warranty shall extend only to the repair or replacement of a defective product, at The Company's option. The Company disclaims all liability for any affirmation, promise or representation with respect to the products.

The customer agrees to hold Red Lion Controls harmless from, defend, and indemnify RLC against damages, claims, and expenses arising out of subsequent sales of RLC products or products containing components manufactured by RLC and based upon personal injuries, deaths, property damage, lost profits, and other matters which Buyer, its employees, or sub-contractors are or may be to any extent liable, including without limitation penalties imposed by the Consumer Product Safety Act (P.L. 92-573) and liability imposed upon any person pursuant to the Magnuson-Moss Warranty Act (P.L. 93-637), as now in effect or as amended hereafter.

No warranties expressed or implied are created with respect to The Company's products except those expressly contained herein. The Customer acknowledges the disclaimers and limitations contained herein and relies on no other warranties or affirmations.

Red Lion Controls  
Headquarters  
20 Willow Springs Circle  
York PA 17406  
Tel +1 (717) 767-6511  
Fax +1 (717) 764-0839



Red Lion Controls  
Europe  
Softwareweg 9  
NL - 3821 BN Amersfoort  
Tel +31 (0) 334 723 225  
Fax +31 (0) 334 893 793

Red Lion Controls  
India  
201-B, 2nd Floor, Park Centra  
Opp 32 Mile Stone, Sector-30  
Gurgaon-122002 Haryana, India  
Tel +91 984 487 0503

Red Lion Controls  
China  
Unit 302, XinAn Plaza  
Building 13, No.99 Tianzhou Road  
ShangHai, P.R. China 200223  
Tel +86 21 6113 3688  
Fax +86 21 6113 3683

## Looking for pricing, stock, or lifecycle information?

Click below to explore more details on WIN SOURCE:

-  [View TCU10204 on WIN SOURCE](#)
-  [Red Lion Controls Information](#)

## Optimize Your Supply Chain with WIN SOURCE Solutions

-  Global Sourcing Solution
-  Obsolete Management
-  Cost Control Management
-  Shortage Management
-  Alternative Solution
-  Excess Inventory Management