



**THE DATASHEET OF
CKR06BX105KPVTR2**





Multilayer Ceramic Leaded Capacitors

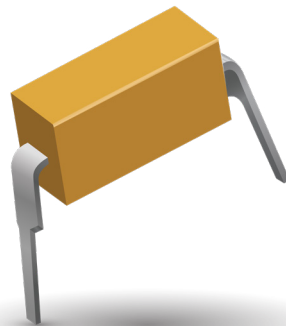
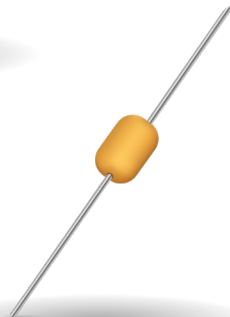
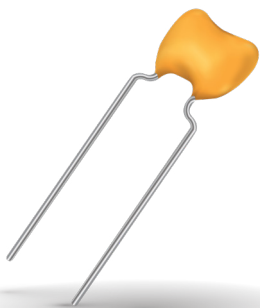

IMPORTANT INFORMATION/DISCLAIMER

All product specifications, statements, information and data (collectively, the “Information”) in this datasheet or made available on the website are subject to change. The customer is responsible for checking and verifying the extent to which the Information contained in this publication is applicable to an order at the time the order is placed. All Information given herein is believed to be accurate and reliable, but it is presented without guarantee, warranty, or responsibility of any kind, expressed or implied.

Statements of suitability for certain applications are based on KYOCERA AVX’s knowledge of typical operating conditions for such applications, but are not intended to constitute and KYOCERA AVX specifically disclaims any warranty concerning suitability for a specific customer application or use.

ANY USE OF PRODUCT OUTSIDE OF SPECIFICATIONS OR ANY STORAGE OR INSTALLATION INCONSISTENT WITH PRODUCT GUIDANCE VOIDS ANY WARRANTY.

The Information is intended for use only by customers who have the requisite experience and capability to determine the correct products for their application. Any technical advice inferred from this Information or otherwise provided by KYOCERA AVX with reference to the use of KYOCERA AVX’s products is given without regard, and KYOCERA AVX assumes no obligation or liability for the advice given or results obtained.

Although KYOCERA AVX designs and manufactures its products to the most stringent quality and safety standards, given the current state of the art, isolated component failures may still occur. Accordingly, customer applications which require a high degree of reliability or safety should employ suitable designs or other safeguards (such as installation of protective circuitry or redundancies) in order to ensure that the failure of an electrical component does not result in a risk of personal injury or property damage.

Unless specifically agreed to in writing, KYOCERA AVX has not tested or certified its products, services or deliverables for use in high risk applications including medical life support, medical device, direct physical patient contact, water treatment, nuclear facilities, weapon systems, mass and air transportation control, flammable environments, or any other potentially life critical uses. Customer understands and agrees that KYOCERA AVX makes no assurances that the products, services or deliverables are suitable for any high-risk uses. Under no circumstances does KYOCERA AVX warrant or guarantee suitability for any customer design or manufacturing process.

Although all product-related warnings, cautions and notes must be observed, the customer should not assume that all safety measures are indicated or that other measures may not be required.

MULTILAYER CERAMIC LEADED CAPACITORS



Table of Contents

THE CAPACITOR	1
DIELECTRICS	
C0G (NP0) Dielectric “A”	9
X7R Dielectric “C”.....	10
X5R Dielectric “D”.....	11
X8R Dielectric “F”.....	12
Z5U Dielectric “E”.....	13
RADIAL LEADS	
SkyCap®/SR Series	14
SkyCap®/SL Series.....	18
SkyCap®/AR Series – Automotive	22
SkyCap® Configurations	29
Ceramam®	31
Packaging.....	35
TWO PIN DIP	
DIPGuard®	37
AXIAL LEADS	
SpinGuard®/SA Series	39
SpinGuard® - AA Series	44
Ceramam®	47
Packaging.....	51
MILITARY	
MIL-PRF-39014	
Radial Leads.....	52
Axial Leads.....	56
2Pin DIP.....	60
MIL-C-11015	
Radial Leads.....	66
Axial Leads.....	68
MIL-PRF-20	
Radial Leads.....	70
Axial Leads.....	72
Marking	75
MIL-PRF-123	
How to Order / Cross Reference.....	76
Radial Leads.....	77
Axial Leads.....	78
2 Pin DIP	81
Marking	82
EUROPEAN CECC	
Detail Specifications	83

NOTICE: Specifications are subject to change without notice. Contact your nearest KYOCERA AVX Sales Office for the latest specifications. All statements, information and data given herein are believed to be accurate and reliable, but are presented without guarantee, warranty, or responsibility of any kind, expressed or implied. Statements or suggestions concerning possible use of our products are made without representation or warranty that any such use is free of patent infringement and are not recommendations to infringe any patent. The user should not assume that all safety measures are indicated or that other measures may not be required. Specifications are typical and may not apply to all applications.

© AVX Corporation

GENERAL DESCRIPTION

A capacitor is a component which is capable of storing electrical energy. It consists of two conductive plates (electrodes) separated by insulating material which is called the dielectric. A typical formula for determining capacitance is:

$$C = \frac{.224 KA}{t}$$

- C** = capacitance (picofarads)
- K** = dielectric constant (Vacuum = 1)
- A** = area in square inches
- t** = separation between the plates in inches (thickness of dielectric)
- .224** = conversion constant (.0884 for metric system in cm)

Capacitance – The standard unit of capacitance is the farad. A capacitor has a capacitance of 1 farad when 1 coulomb charges it to 1 volt. One farad is a very large unit and most capacitors have values in the micro (10^{-6}), nano (10^{-9}) or pico (10^{-12}) farad level.

Dielectric Constant – In the formula for capacitance given above the dielectric constant of a vacuum is arbitrarily chosen as the number 1. Dielectric constants of other materials are then compared to the dielectric constant of a vacuum.

Dielectric Thickness – Capacitance is indirectly proportional to the separation between electrodes. Lower voltage requirements mean thinner dielectrics and greater capacitance per volume.

Area – Capacitance is directly proportional to the area of the electrodes. Since the other variables in the equation are usually set by the performance desired, area is the easiest parameter to modify to obtain a specific capacitance within a material group.

Energy Stored – The energy which can be stored in a capacitor is given by the formula:

$$E = \frac{1}{2}CV^2$$

- E** = energy in joules (watts-sec)
- V** = applied voltage
- C** = capacitance in farads

Potential Change – A capacitor is a reactive component which reacts against a change in potential across it. This is shown by the equation for the linear charge of a capacitor:

$$I_{ideal} = C \frac{dV}{dt}$$

where

- I** = Current
- C** = Capacitance
- dV/dt** = Slope of voltage transition across capacitor

Thus an infinite current would be required to instantly change the potential across a capacitor. The amount of current a capacitor can “sink” is determined by the above equation.

Equivalent Circuit – A capacitor, as a practical device, exhibits not only capacitance but also resistance and inductance. A simplified schematic for the equivalent circuit is:

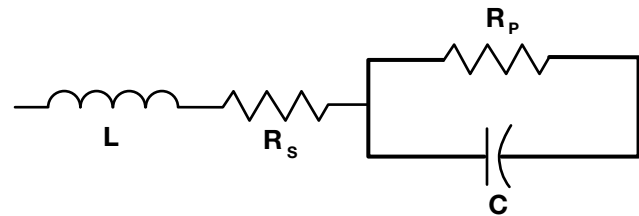

- C** = Capacitance
- L** = Inductance
- Rs** = Series Resistance
- Rp** = Parallel Resistance

Reactance – Since the insulation resistance (R_p) is normally very high, the total impedance of a capacitor is:

$$Z = \sqrt{R_s^2 + (X_C - X_L)^2}$$

where

- Z** = Total Impedance
- Rs** = Series Resistance
- X_C** = Capacitive Reactance = $\frac{1}{2 \pi fC}$
- X_L** = Inductive Reactance = $2 \pi fL$

The variation of a capacitor's impedance with frequency determines its effectiveness in many applications.

Phase Angle – Power Factor and Dissipation Factor are often confused since they are both measures of the loss in a capacitor under AC application and are often almost identical in value. In a “perfect” capacitor the current in the capacitor will lead the voltage by 90° .

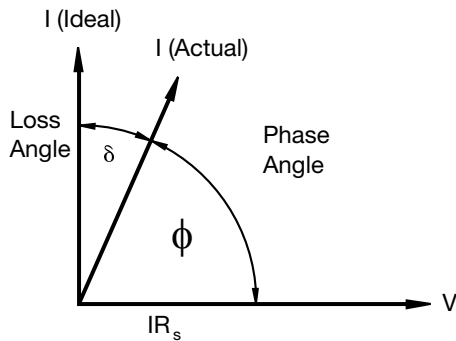

In practice the current leads the voltage by some other phase angle due to the series resistance R_s . The complement of this angle is called the loss angle and:

$$\text{Power Factor (P.F.)} = \cos \phi \text{ or Sine } \delta$$

$$\text{Dissipation Factor (D.F.)} = \tan \delta$$

for small values of the tan and sine are essentially equal which has led to the common interchangeability of the two terms in the industry.

Equivalent Series Resistance – The term E.S.R. or Equivalent Series Resistance combines all losses both series and parallel in a capacitor at a given frequency so that the equivalent circuit is reduced to a simple R-C series connection.

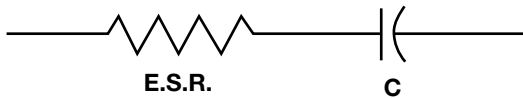

Dissipation Factor

The DF/PF of a capacitor tells what percent of the apparent power input will turn to heat in the capacitor.

$$\text{Dissipation Factor} = \frac{\text{E.S.R.}}{X_c} = (2 \pi fC) (\text{E.S.R.})$$

The watts loss are:

$$\text{Watts loss} = (2 \pi fCV^2) (\text{D.F.})$$

Very low values of dissipation factor are expressed as their reciprocal for convenience. These are called the “Q” or Quality factor of capacitors.

Insulation Resistance – Insulation Resistance is the resistance

measured across the terminals of a capacitor and consists principally of the parallel resistance R_p shown in the equivalent circuit. As capacitance values and hence the area of dielectric increases, the I.R. decreases and hence the product ($C \times IR$ or RC) is often specified in ohm farads or more commonly megohm microfarads. Leakage current is determined by dividing the rated voltage by IR (Ohm’s Law).

Dielectric Strength – Dielectric Strength is an expression of the ability of a material to withstand an electrical stress. Although dielectric strength is ordinarily expressed in volts, it is actually dependent on the thickness of the dielectric and thus is also more generically a function of volts/mil.

Dielectric Absorption – A capacitor does not discharge instantaneously upon application of a short circuit, but drains gradually after the capacitance proper has been discharged. It is common practice to measure the dielectric absorption by determining the “reappearing voltage” which appears across a capacitor at some point in time after it has been fully discharged under short circuit conditions.

Corona – Corona is the ionization of air or other vapors which causes them to conduct current. It is especially prevalent in high voltage units but can occur with low voltages as well where high voltage gradients occur. The energy discharged degrades the performance of the capacitor and can in time cause catastrophic failures.

CERAMIC CAPACITORS

Multilayer ceramic capacitors are manufactured by mixing the ceramic powder in an organic binder (slurry) and casting it by one technique or another into thin layers typically ranging from about 3 mils in thickness down to 1 mil or thinner.

Metal electrodes are deposited onto the green ceramic layers which are then stacked to form a laminated structure. The metal electrodes are arranged so that their terminations alternate from one edge of the capacitor to another. Upon sintering at high temperature the part becomes a monolithic block which can provide extremely high capacitance values in small mechanical volumes. Figure 1 shows a pictorial view of a multilayer ceramic capacitor.

Multilayer ceramic capacitors are available in a wide range of characteristics, Electronic Industries Association (EIA) and the military have established categories to help divide the basic characteristics into more easily specified classes. The basic industry specification for ceramic capacitors is EIA specification RS-198 and as noted in the general section it specifies temperature compensating

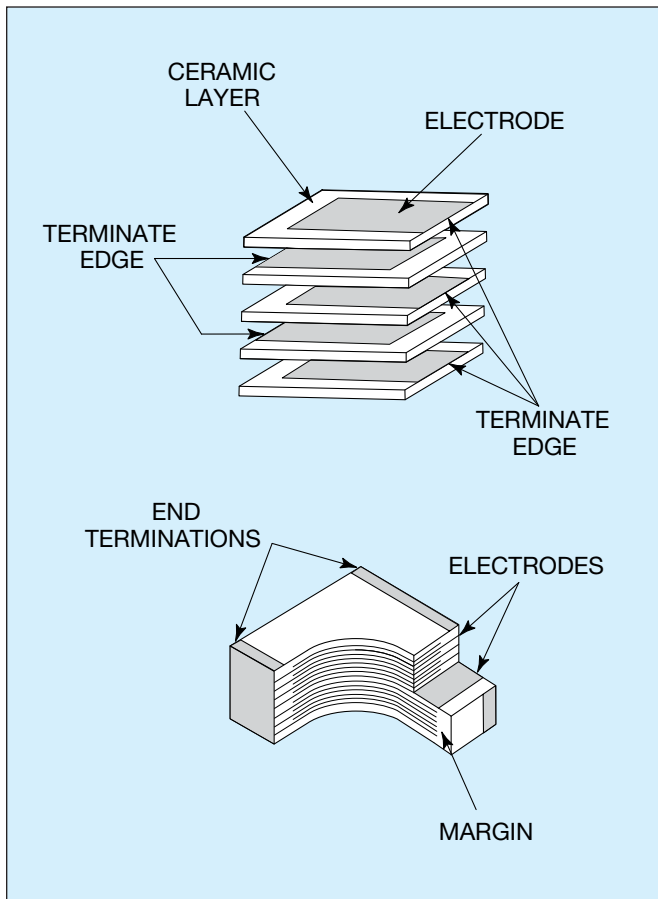

Figure 1

EIA Temperature Compensating Ceramic temperature characteristics in accordance with EIA-198.

capacitors as Class 1 capacitors. These are specified by the military under specification MIL-PRF-20. General purpose capacitors with non-linear temperature coefficients are called Class 2 capacitors by EIA and are specified by the military under MIL-C-11015 and MIL-PRF-39014. The new high reliability military specification, MIL-PRF-123 covers both Class 1 and Class 2 dielectrics.

Class 1 – Class 1 capacitors or temperature compensating capacitors are usually made from mixtures of titanates where barium titanate is normally not a major part of the mix. They have predictable temperature coefficients and in general, do not have an aging characteristic. Thus they are the most stable capacitor available. Normally the T.C.s of Class 1 temperature compensating capacitors are COG (NPO) (negative-positive 0 ppm/°C). Class 1 extended temperature compensating capacitors are also manufactured in T.C.s from P100 through N2200.

Class 2 – General purpose ceramic capacitors are called Class 2 capacitors and have become extremely popular because of the high capacitance values available in very small size. Class 2 capacitors are “ferro electric” and vary in capacitance value under the influence of the environmental and electrical operating conditions. Class 2 capacitors are affected by temperature, voltage (both AC and DC), frequency and time. Temperature effects for Class 2 ceramic capacitors are exhibited as non-linear capacitance changes with temperature.

Table 2: MIL and EIA Temperature Stable and General Application Codes

MIL CODE		
Symbol	Temperature Range	
A	-55°C to +85°C	
B	-55°C to +125°C	
C	-55°C to +150°C	
Symbol	Cap. Change Zero Volts	Cap. Change Rated Volts
R	+15%, -15%	+15%, -40%
W	+22%, -56%	+22%, -66%
X	+15%, -15%	+15%, -25%
Y	+30%, -70%	+30%, -80%
Z	+20%, -20%	+20%, -30%

Temperature characteristic is specified by combining range and change symbols, for example BR or AW. Specification slash sheets indicate the characteristic applicable to a given style of capacitor.

EIA CODE	
Percent Capacity Change Over Temperature Range	
RS198	Temperature Range
X7	-55°C to +125°C
X5	-55°C to +85°C
Y5	-30°C to +85°C
Z5	+10°C to +85°C
Code	Percent Capacity Change
D	±3.3%
E	±4.7%
F	±7.5%
P	±10%
R	±15%
S	±22%
T	+22%, -33%
U	+22%, -56%
V	+22%, -82%

EXAMPLE – A capacitor is desired with the capacitance value at 25°C to increase no more than 7.5% or decrease no more than 7.5% from -30°C to +85°C. EIA Code will be Y5F.

In specifying capacitance change with temperature for Class 2 materials, EIA expresses the capacitance change over an operating temperature range by a 3 symbol code. The first symbol represents the cold temperature end of the temperature range, the second represents the upper limit of the operating temperature range and the third symbol represents the capacitance change allowed over the operating temperature range. Table 2 provides a detailed explanation of the EIA system.

Effects of Voltage – Variations in voltage affects only the capacitance and dissipation factor. The application of DC voltage reduces both the capacitance and dissipation factor

while the application of an AC voltage within a reasonable range tends to increase both capacitance and dissipation factor readings. If a high enough AC voltage is applied, eventually it will reduce capacitance just as a DC voltage will. Figure 2 shows the effects of AC voltage.

Capacitor specifications specify the AC voltage at which to measure (normally 0.5 or 1 VAC) and application of the wrong voltage can cause spurious readings. Figure 3 gives the voltage coefficient of dissipation factor for various AC voltages at 1 kilohertz. Applications of different frequencies will affect the percentage changes versus voltages.

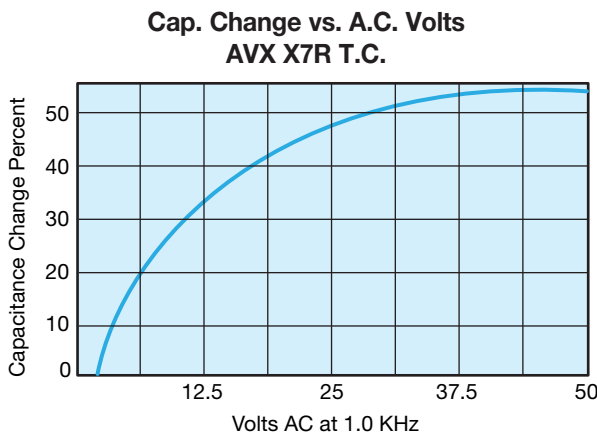

Figure 2

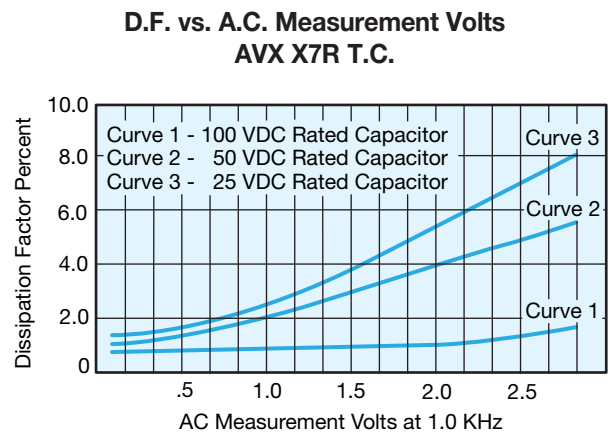

Figure 3

The effect of the application of DC voltage is shown in Figure 4. The voltage coefficient is more pronounced for higher K dielectrics. These figures are shown for room temperature conditions. The combination characteristic known as voltage temperature limits which shows the effects of rated voltage over the operating temperature range is shown in Figure 5 for the military BX characteristic.

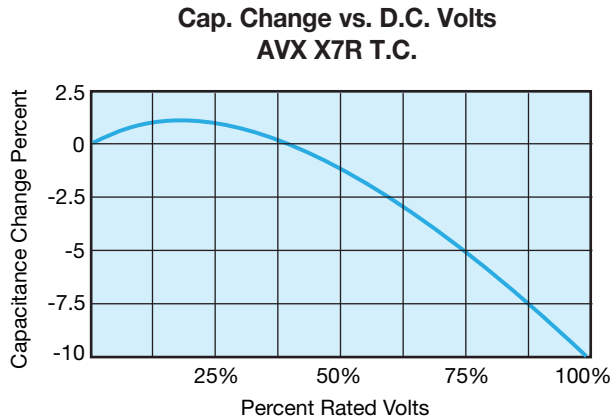

Figure 4

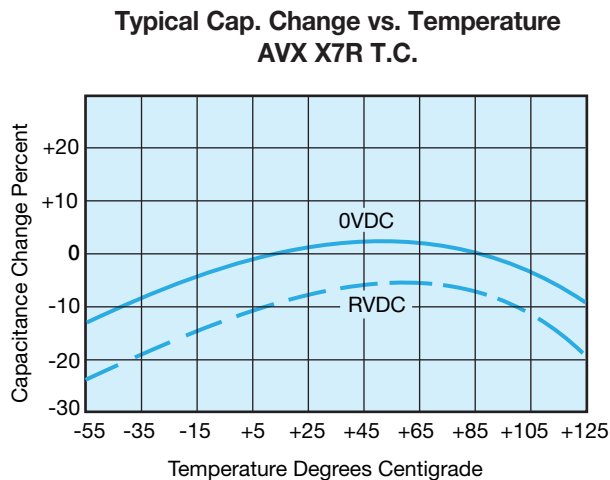

Figure 5

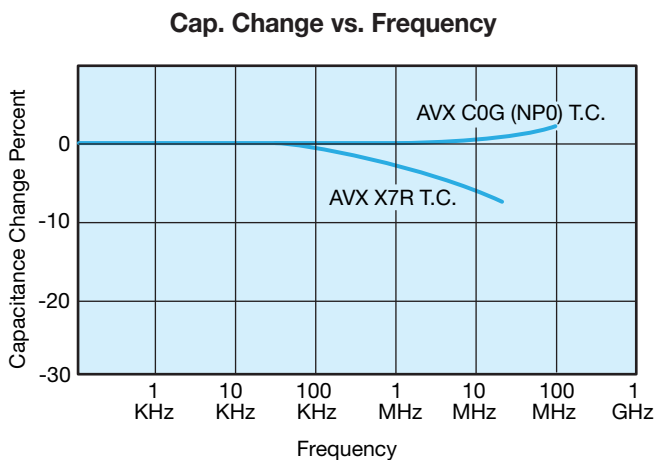

Figure 6

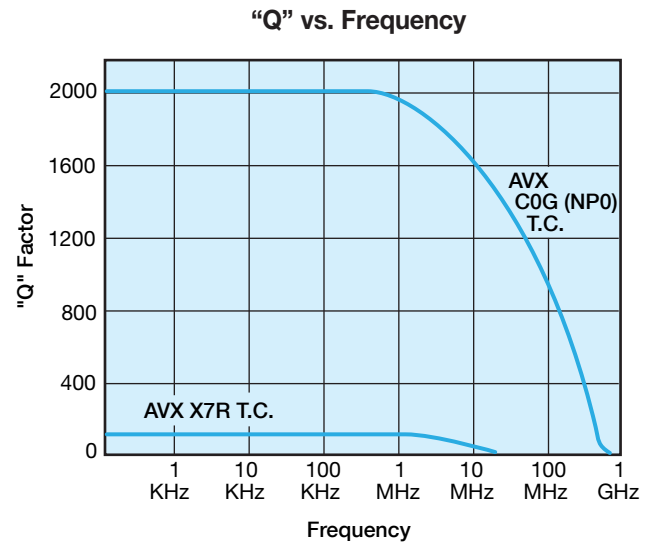

Figure 7

Effects of Frequency – Frequency affects capacitance and dissipation factor as shown in Figures 6 and 7.

Variation of impedance with frequency is an important consideration for decoupling capacitor applications. Lead length, lead configuration and body size all affect the impedance level over more than ceramic formulation variations. (Figure 8)

Effects of Time – Class 2 ceramic capacitors change capacitance and dissipation factor with time as well as temperature, voltage and frequency. This change with time is known as aging. Aging is caused by a gradual re-alignment of the crystalline structure of the ceramic and produces an exponential loss in capacitance and decrease in dissipation factor versus time. A typical curve of aging rate for semistable ceramics is shown in Figure 9 and a table is given showing the aging rates of various dielectrics.

If a ceramic capacitor that has been sitting on the shelf for a period of time, is heated above its curie point, (125°C for 4 hours or 150°C for 1/2 hour will suffice) the part will de-age and return to its initial capacitance and dissipation factor readings. Because the capacitance changes rapidly, immediately after de-aging, the basic capacitance measurements are normally referred to a time period sometime after the de-aging process. Various manufacturers use different time bases but the most popular one is one day or twenty-four hours after “last heat.” Change in the aging curve can be caused by the application of voltage and other stresses. The possible changes in capacitance due to de-aging by heating the unit explain why capacitance changes are allowed after test, such as temperature cycling, moisture resistance, etc., in MIL specs. The application of high voltages such as dielectric withstanding voltages also tends to de-age capacitors and is why re-reading of capacitance after 12 or 24 hours is allowed in military specifications after dielectric strength tests have been performed.

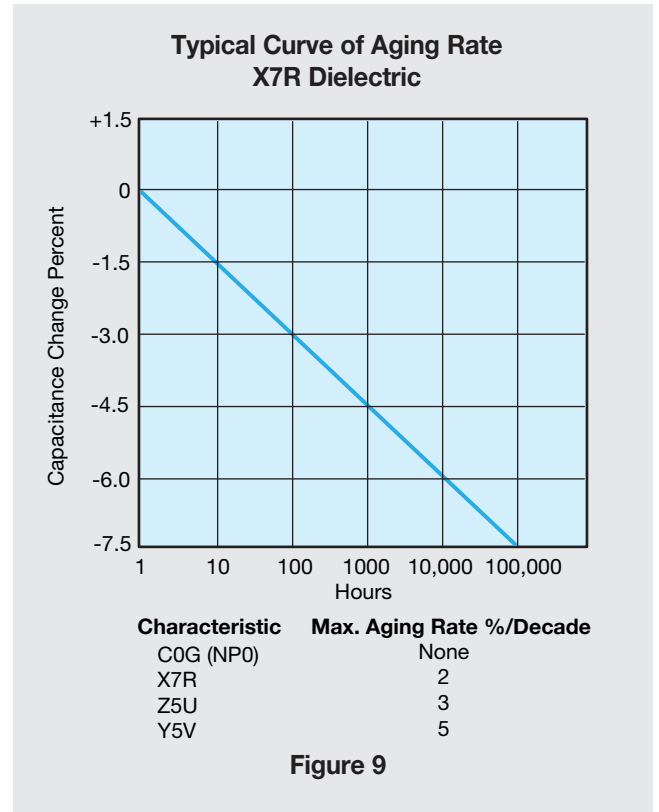
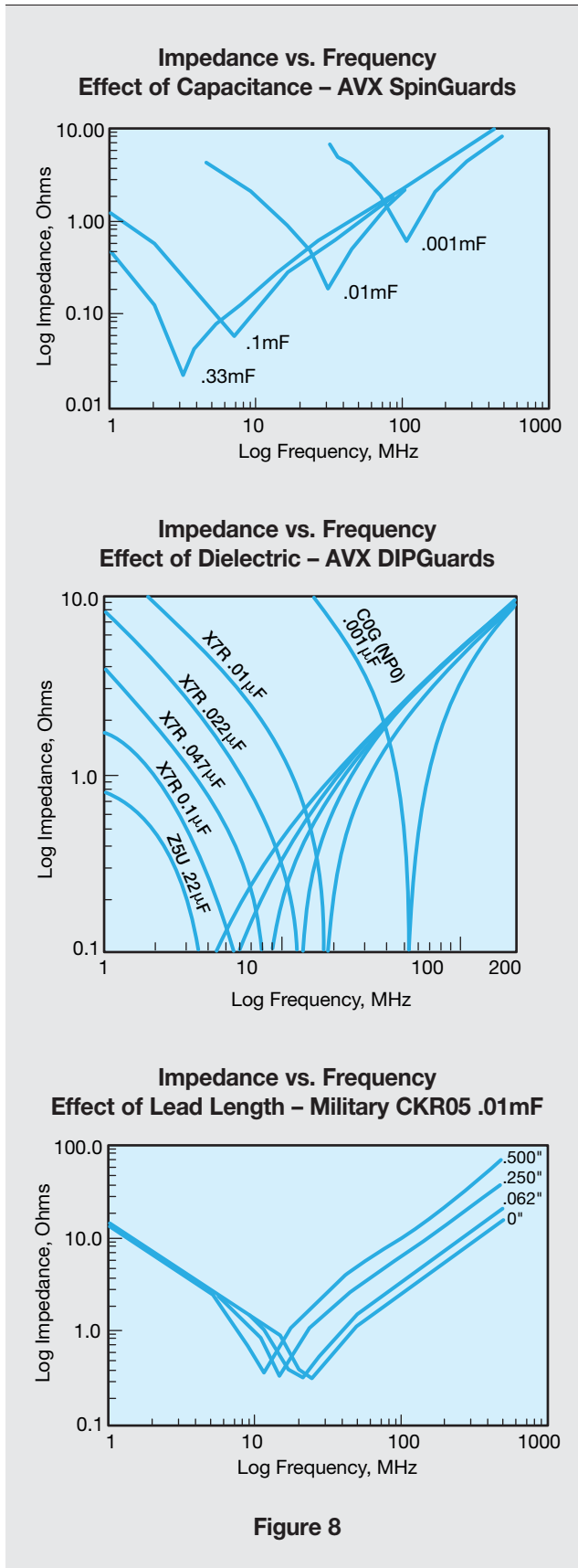

Effects of Mechanical Stress – High “K” dielectric ceramic capacitors exhibit some low level piezoelectric reactions under mechanical stress. As a general statement, the piezoelectric output is higher, the higher the dielectric constant of the ceramic. It is desirable to investigate this effect before using high “K” dielectrics as coupling capacitors in extremely low level applications.

Reliability – Historically ceramic capacitors have been one of the most reliable types of capacitors in use today. The approximate formula for the reliability of a ceramic capacitor is:

$$\frac{L_o}{L_t} = \left(\frac{V_t}{V_o}\right)^X \times \left(\frac{T_t}{T_o}\right)^Y$$

where

- L_o = operating life
- L_t = test life
- V_t = test voltage
- V_o = operating voltage
- T_t = test temperature and
- T_o = operating temperature in °C
- X, Y = see text

Historically for ceramic capacitors exponent X has been considered as 3. The exponent Y for temperature effects typically tends to run about 8.

THE CAPACITOR

General Electrical and Environmental Specifications

Many KYOCERA AVX ceramic capacitors are purchased in accordance with Military Specifications, MIL-PRF-39014, MIL-C-11015, MIL-PRF-20, MIL-PRF-55681, and MIL-PRF-123 or according to individual customer specification. When ordered to these specifications, the parts will meet the requirements set forth in these documents. The General Electrical and Environmental Specifications listed below detail test conditions which are common to the foregoing and to most ceramic capacitor specifications. If additional information is needed, KYOCERA AVX Application Engineers are ready to assist you.

Capacitance – Capacitance shall be tested in accordance with Method 305 of MIL-STD-202.

Class 1 dielectric to 1000 pF measured at 1 MHz, ± 100 KHz, > 1000 pF measured at 1 KHz ± 100 Hz both at 1.0 ± 0.2 VAC.

Class 2 dielectrics (except High K) to 100 pF shall be measured at 1 MHz ± 100 KHz, > 100 pF measured at 1 KHz ± 100 Hz both at 1.0 ± 0.2 VAC.

High K dielectrics measured at 1 KHz ± 100 Hz with less than 1.5 VAC or less applied.

Dissipation Factor – D.F. shall be measured at the same frequency and voltage as specified for capacitance.

Dielectric Strength – The dielectric strength shall be measured in accordance with Method 301 of MIL-STD-202 with a suitable resistor in series with the power supply to limit the charging current to 50 ma. max.

Insulation Resistance – Insulation Resistance shall be measured in accordance with Method 302 of MIL-STD-202 with rated voltage or 200 VDC whichever is less applied. The current shall be limited to 50 ma. max. and the charging time shall be 2.0 minutes maximum.

Burn-In – (Where specified.) 100% of the parts shall be subjected to 5 cycles of Thermal Shock per Method 107 Test Condition A of MIL-STD-202 followed by voltage conditioning at twice rated voltage and maximum rated temperature for 100 hours or as specified. After Burn-In, parts shall meet all initial requirements.

Barometric Pressure – Capacitors shall be tested in accordance with Method 105 of MIL-STD-202 Test Condition D (100,000 ft.) with 100% rated voltage applied for 5 seconds with current limited to 50 ma. No evidence of flashover or damage is permitted.

Solderability – Capacitors shall be tested in accordance with Method 208 of MIL-STD-202 with 95% coverage of new solder.

Vibration – Capacitors shall be tested in accordance with Method 208 Test Condition D of MIL-STD-202 with the bodies rigidly clamped. The specimens shall be tested in 3 mutually perpendicular planes for a total of 8 hours with 125% rated DC voltage applied. No evidence of opens, intermittents or shorts

is permitted.

Shock – Capacitors shall be tested in accordance with Method 213 Condition 1 (100 Gs) of MIL-STD-202 with the bodies rigidly clamped. No evidence of opens, intermittents or shorts is permitted.

Thermal Shock and Immersion – Capacitors shall be tested in accordance with Method 107 Condition A of MIL-STD-202 with high test temperature (maximum rated operating temperature) followed by Method 104 of MIL-STD-202 Test Condition B.

Moisture Resistance – Capacitors shall be tested in accordance with Method 106 of MIL-STD-202 with rated voltage or 100 VDC whichever is less applied for the first 10 cycles.

Resistance to Solder Heat – Capacitors shall be tested in accordance with Method 210 of MIL-STD-202 with immersion to .050 of body. KYOCERA AVX Ceralam capacitors are manufactured with solder which melts at a temperature greater than 450°F.

General Considerations – The application of voltage or temperature usually causes temporary changes in the capacitance of Class 2 ceramic capacitors. These changes are normally in the positive direction and may cause out-of-tolerance capacitance readings. If a capacitance reading is made immediately after a dielectric strength or insulation resistance test and parts are high capacitance, they should be re-read after a minimum wait of 12 hours.

BASIC CAPACITOR FORMULAS

I. Capacitance (farads)

$$\text{English: } C = \frac{.224 \text{ K A}}{T_o}$$

$$\text{Metric: } C = \frac{.0884 \text{ K A}}{T_o}$$

II. Energy stored in capacitors (Joules, watt - sec)

$$E = \frac{1}{2} CV^2$$

III. Linear charge of a capacitor (Amperes)

$$I = C \frac{dV}{dt}$$

IV. Total Impedance of a capacitor (ohms)

$$Z = \sqrt{R_s^2 + (X_C - X_L)^2}$$

V. Capacitive Reactance (ohms)

$$X_C = \frac{1}{2 \pi fC}$$

VI. Inductive Reactance (ohms)

$$X_L = 2 \pi fL$$

VII. Phase Angles:

Ideal Capacitors: Current leads voltage 90°

Ideal Inductors: Current lags voltage 90°

Ideal Resistors: Current in phase with voltage

VIII. Dissipation Factor (%)

$$D.F. = \tan \delta \text{ (loss angle)} = \frac{E.S.R.}{X_C} = (2 \pi fC) (E.S.R.)$$

IX. Power Factor (%)

P.F. = Sine (loss angle) = Cos ϕ (phase angle)

P.F. = (when less than 10%) = DF

X. Quality Factor (dimensionless)

$$Q = \text{Cotan (loss angle)} = \frac{1}{D.F.}$$

XI. Equivalent Series Resistance (ohms)

$$E.S.R. = (D.F.) (X_C) = (D.F.) / (2 \pi fC)$$

XII. Power Loss (watts)

$$\text{Power Loss} = (2 \pi fCV^2) (D.F.)$$

XIII. KVA (Kilowatts)

$$KVA = 2 \pi fCV^2 \times 10^{-3}$$

XIV. Temperature Characteristic (ppm/°C)

$$T.C. = \frac{C_t - C_{25}}{C_{25} (T_t - 25)} \times 10^6$$

XV. Cap Drift (%)

$$C.D. = \frac{C_1 - C_2}{C_1} \times 100$$

XVI. Reliability of Ceramic Capacitors

$$\frac{L_o}{L_t} = \left(\frac{V_t}{V_o} \right) \times \left(\frac{T_t}{T_o} \right)^Y$$

XVII. Capacitors in Series (current the same)

$$\text{Any Number: } \frac{1}{C_T} = \frac{1}{C_1} + \frac{1}{C_2} \dots \frac{1}{C_N}$$

$$\text{Two: } C_T = \frac{C_1 C_2}{C_1 + C_2}$$

XVIII. Capacitors in Parallel (voltage the same)

$$C_T = C_1 + C_2 \dots + C_N$$

XIX. Aging Rate

$$A.R. = \% \Delta C / \text{decade of time}$$

XX. Decibels

$$db = 20 \log \frac{V_1}{V_2}$$

METRIC PREFIXES - SYMBOLS

Pico	X 10 ⁻¹²	K	= Dielectric Constant	f	= frequency	L _t	= Test life
Nano	X 10 ⁻⁹	A	= Area	L	= Inductance	V _t	= Test voltage
Micro	X 10 ⁻⁶	T _D	= Dielectric thickness	δ	= Loss angle	V _o	= Operating voltage
Milli	X 10 ⁻³	V	= Voltage	φ	= Phase angle	T _t	= Test temperature
Deci	X 10 ⁻¹	t	= time	X & Y	= exponent effect of voltage and temp.	T _o	= Operating temperature
Deca	X 10 ⁺¹	R _s	= Series Resistance	L _o	= Operating life		
Kilo	X 10 ⁺³						
Mega	X 10 ⁺⁶						
Giga	X 10 ⁺⁹						
Tera	X 10 ⁺¹²						

DIELECTRICS

C0G (NP0) Dielectric "A"

GENERAL SPECIFICATIONS

Capacitance Range

See Individual Parts Specifications

Capacitance Test at 25°C

Measured at 1 VRMS max. at 1 KHz
(1 MHz for 1,000 pF or less)

Capacitance Tolerances

C = ± 0.25 pF, D = ± 0.50 pF, E = $\pm 0.5\%$, F = $\pm 1.0\%$, G = $\pm 2\%$, H = $\pm 3\%$, J = $\pm 5\%$, K = $\pm 10\%$, M = $\pm 20\%$ For values less than 10 pF tightest tolerance available is ± 0.25 pF

Operating Temperature Range

-55°C to +125°C

Temperature Characteristic

0 \pm 30 ppm/°C

Voltage Ratings

500, 200, 100 & 50 Vdc

Dissipation Factor

.15% max. (+25°C and +125°C) for values greater than 30 pF or Q = 20 x C + 400 for values of 30 pF and below. 1.0 VRMS, 1 MHz for values $<?>$ 1,000 pF, and 1 KHz for values > 1,000 pF

Insulation Resistance 25°C (MIL-STD-202-Method 302)

100 K megohms or 1000 megohms - μ F minimum, whichever is less

Dielectric Strength

250% of rated Vdc

Life Test (1,000 hours)

200% rated voltage at +125°C

Moisture Resistance (MIL-STD-202-Method 106)

Thermal Shock (MIL-STD-202-Method 107, condition A, at rated elevated temperature)

-55°C to +125°C

Immersion Cycling (MIL-STD-202-Method 104, condition B)

For current reliability information, consult factory.

TYPICAL CHARACTERISTICS

Temperature Coefficient

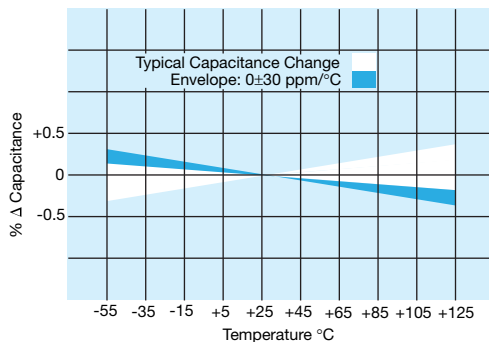

Voltage Coefficient

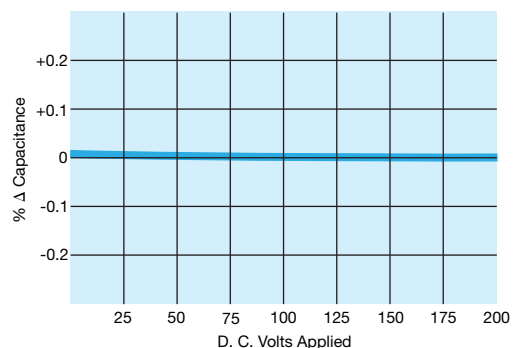

Aging Rate

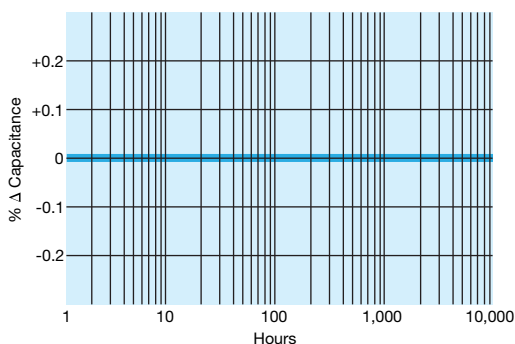

Insulation Resistance vs. Temp.

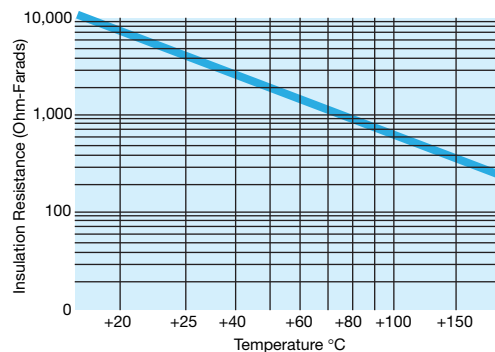

DIELECTRICS

X7R Dielectric "C"

GENERAL SPECIFICATIONS

Capacitance Range

See Individual Parts Specifications

Capacitance Test at 25°C

Measured at 1 VRMS max. at 1 KHz

Capacitance Tolerances

J = ±5%, K = ±10%, M = ±20%

Operating Temperature Range

-55°C to +125°C

Temperature Characteristic

± 15% (0 Vdc)

Voltage Ratings

500, 200, 100 & 50 Vdc

Dissipation Factor

2.5% max. at 1 KHz, 1 VRMS max.

Insulation Resistance 25°C (MIL-STD-202-Method 302)

100 K megohms or 1000 megohms - μ F minimum, whichever is less

Dielectric Strength

250% of rated Vdc

Life Test (1,000 hours)

200% rated voltage at +125°C

Moisture Resistance (MIL-STD-202-Method 106)

Thermal Shock (MIL-STD-202-Method 107, condition A, at rated elevated temperature)

-55°C to +125°C

Immersion Cycling (MIL-STD-202-Method 104, condition B)

For current reliability information, consult factory.

TYPICAL CHARACTERISTICS

Temperature Coefficient

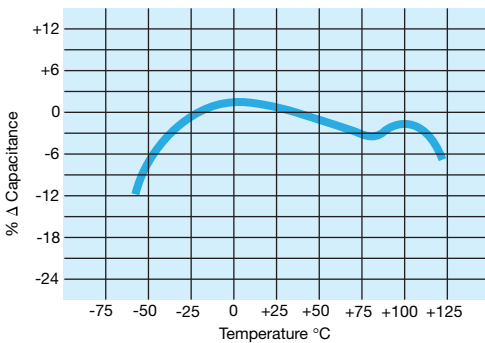

Voltage Coefficient

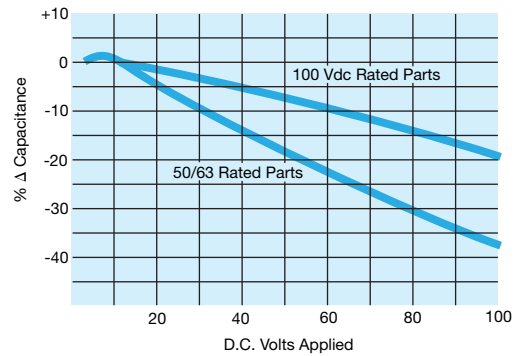

Δ Capacitance vs. Frequency

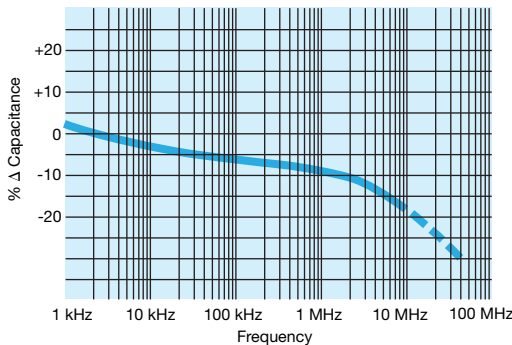

Insulation Resistance vs. Temp.

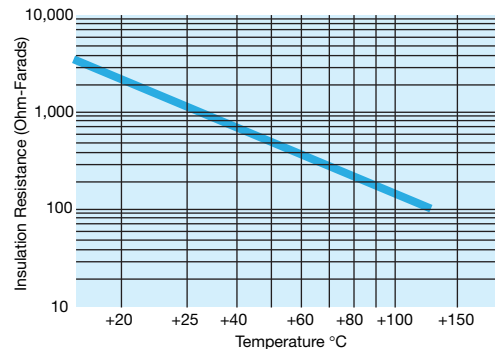

DIELECTRICS

X5R Dielectric "D"

GENERAL DESCRIPTION

- General Purpose Dielectric for Ceramic Capacitors
- EIA Class II Dielectric
- Temperature variation of capacitance is within $\pm 15\%$ from -55°C to $+85^{\circ}\text{C}$
- Well suited for decoupling and filtering applications
- Available in High Capacitance values (up to $100\mu\text{F}$)

TYPICAL ELECTRICAL CHARACTERISTICS

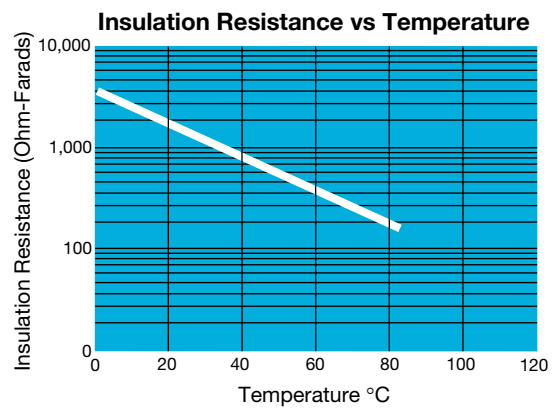
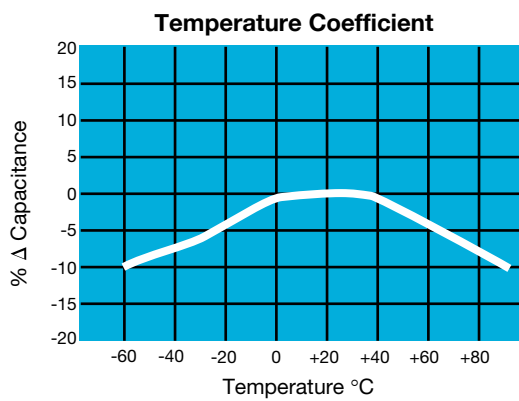

DIELECTRICS

X8R Dielectric "F"



GENERAL SPECIFICATIONS

Capacitance Range

See Individual Parts Specifications

Capacitance Test at 25°C

Measured at 1 VRMS max. at 1 KHz

Capacitance Tolerances

J = ±5%, K = ±10%, M = ±20%

Operating Temperature Range

-55°C to +125°C

Temperature Characteristic

± 15% (0 Vdc)

Voltage Ratings

50 Vdc

Dissipation Factor

2.5% max. at 1 KHz, 1 VRMS max.

Insulation Resistance 25°C (MIL-STD-202-Method 302)

100 K megohms or 1000 megohms - μ F minimum, whichever is less

Dielectric Strength

250% of rated Vdc

Life Test (1,000 hours)

200% rated voltage at +125°C

Moisture Resistance (MIL-STD-202-Method 106)**Thermal Shock (MIL-STD-202-Method 107, condition A, at rated elevated temperature)**

-55°C to +125°C

Immersion Cycling (MIL-STD-202-Method 104, condition B)

For current reliability information, consult factory.

TYPICAL CHARACTERISTICS

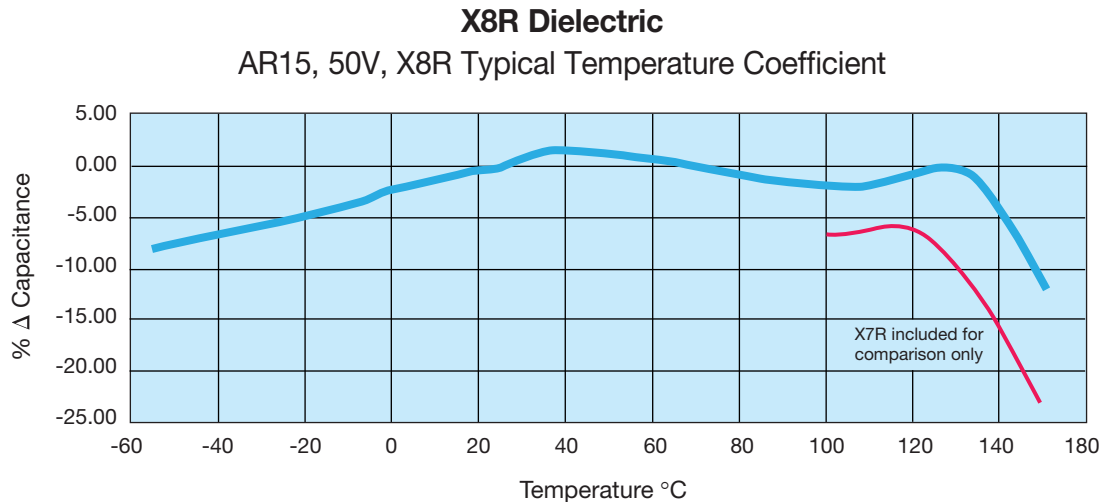

DIELECTRICS

Z5U Dielectric "E"

GENERAL SPECIFICATIONS

Capacitance Range

See Individual Parts Specifications

Capacitance Test at 25°C

Measured at 0.5 VRMS max. at 1 KHz

Capacitance Tolerances

M = $\pm 20\%$, Z = +80%, -20%, P = GMV*

Operating Temperature Range

+10°C to +85°C

Temperature Characteristic

+22%, -56%

Voltage Ratings

100 & 50 Vdc

Dissipation Factor

4.0% max. at 1 KHz, .5 VRMS max.

Insulation Resistance 25°C (MIL-STD-202-Method 302)

10 K megohms or 100 megohms - μF minimum, whichever is less

Dielectric Strength

200% of rated Vdc

Life Test (1,000 hours)

150% rated voltage at +85°C

Moisture Resistance (MIL-STD-202-Method 106)

Immersion Cycling (MIL-STD-202-Method 104, condition B)

For current reliability information, consult factory.

*Guaranteed Minimum Value

TYPICAL CHARACTERISTICS

Temperature Coefficient

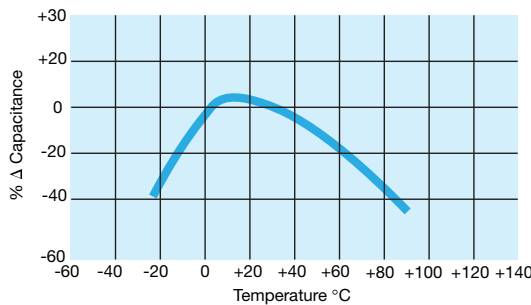

Insulation Resistance vs. Temp.

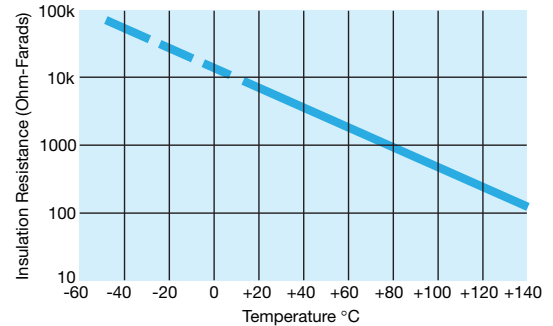

Δ Capacitance vs. Frequency

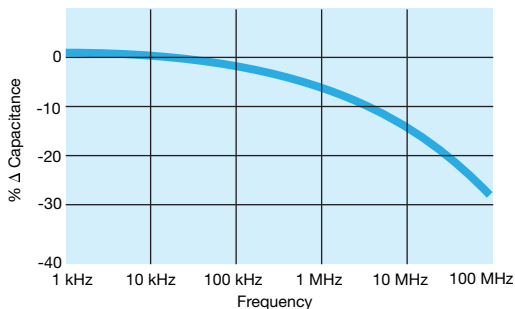

Voltage Coefficient

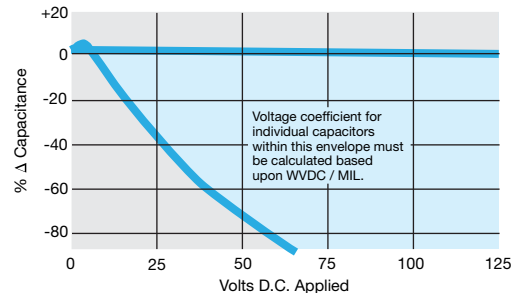

RADIAL LEADS

SkyCap®/SR Series

GENERAL INFORMATION

SR Series

Conformally Coated Radial Leaded MLC

Temperature Coefficients: COG (NP0), X7R, Z5U

200, 100, 50 Volts (300V, 400V & 500V also available)

Case Material: Epoxy

Lead Material: RoHS Compliant, 100% Tin

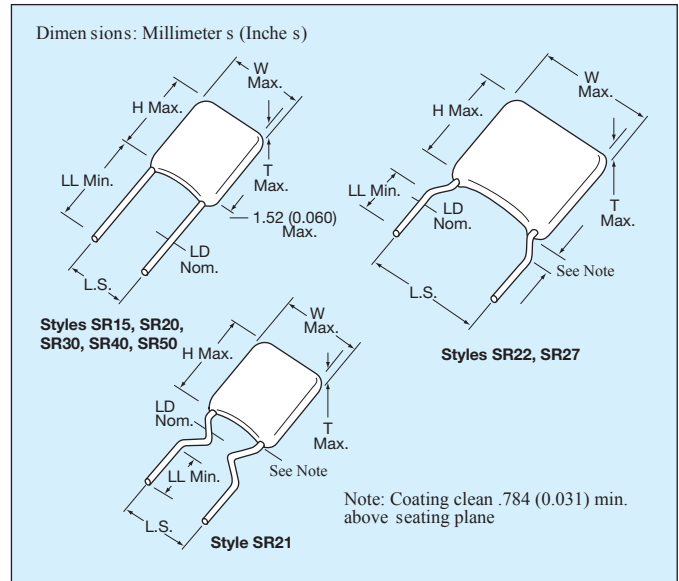

Drawings are for illustrative purposes only. Actual lead form shape could vary within stated tolerances based on body size.

HOW TO ORDER

SR21

5

E

104

M

A

R

TR1

Style

SR15
SR20
SR21
SR22
SR27
SR30
SR40
SR50

Voltage

5 = 50V
1 = 100V
2 = 200V
9 = 300V
8 = 400V
7 = 500V

Temperature Coefficient

A = COG (NP0)
C = X7R
E = Z5U

Capacitance

First two digits are the significant figures of capacitance. Third digit indicates the additional number of zeros. For example, order 100,000 pF as 104. (For values below 10pF use "R" in place of decimal point, e.g., 1R4 = 1.4pF)

Capacitance Tolerance

COG (NP0):
C = ±.25pF
D = ±.5pF
F = ±1% (>50pF only)
G = ±2% (>25pF only)
J = ±5%
K = ±10%

X7R:
J = ±5%
K = ±10%
M = ±20%

Z5U:
M = ±20%
Z = +80%
-20%

Failure Rate

A = Not Applicable

Leads

R = RoHS

Packaging

Blank: Bulk Packaging 1.0" minimum of lead length
T: Trimmed leads .230" ± .030"
Bulk packaging
TR1: Tape and Reel Packaging
AP1: Ammopack packaging

See packaging specification pages 33-34



MARKING

FRONT

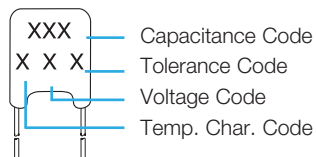

BACK

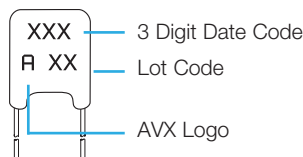

PACKAGING REQUIREMENTS

	Quantity per Bag
SR15, 20, 21, 22, 27, 30	1000 Pieces
SR40, 50	500 Pieces

Note: SR15, SR20, SR21, SR30, and SR40 available on tape and reel per EIA specifications RS-468. See Pages 33 and 34.

RADIAL LEADS

COG (NP0) Dielectric



SIZE AND CAPACITANCE SPECIFICATIONS

EIA Characteristic

Dimensions: Millimeters (Inches)

Style	SR15	SR20	SR21	SR22	SR27	SR30	SR40	SR50													
"Insertable"	SR07	SR29	SR59	N/A	N/A	SR65	SR75	N/A													
Width (W)	3.81 (.150)	5.08 (.200)	5.08 (.200)	5.08 (.200)	6.604 (.260)	7.62 (.300)	10.16 (.400)	12.70 (.500)													
Height (H)	3.81 (.150)	5.08 (.200)	5.08 (.200)	5.08 (.200)	6.35 (.250)	7.62 (.300)	10.16 (.400)	12.70 (.500)													
Thickness (T)	2.54 (.100)	3.175 (.125)	3.175 (.125)	3.175 (.125)	4.06 (.160)	3.81 (.150)	3.81 (.150)	5.08 (.200)													
Lead Spacing (L.S.)	2.54 (.100)	2.54 (.100)	5.08 (.200)	6.35 (.250)	7.62 (.300)	5.08 (.200)	5.08 (.200)	10.16 (.400)													
Lead Diameter (L.D.)	.508 (.020)	.508 (.020)	.508 (.020)	.508 (.020)	.508 (.020)	.508 (.020)	.508 (.020)	.635 (.025)													
Cap. in.* pF	Industry Preferred Values in Blue	WVDC			WVDC			WVDC			WVDC			WVDC		WVDC		WVDC			
		200	100	50	200	100	50	200	100	50	200	100	50	200	100	50	100	50	100	50	
1.0-9.9	SR151A1R0DAR																				
10	SR151A100KAR																				
15	SR.....A150KAR																				
22	SR.....A220KAR																				
33	SR.....A330KAR																				
39	SR.....A390KAR																				
47	SR.....A470KAR																				
68	SR.....A680KAR																				
100	SR151A101KAR																				
150	SR.....A151KAR																				
220	SR.....A221KAR																				
330	SR.....A331KAR																				
390	SR.....A391KAR																				
470	SR.....A471KAR																				
680	SR.....A681KAR																				
1000	SR211A102KAR																				
1500	SR.....A152KAR																				
2200	SR.....A222KAR																				
3900	SR.....A392KAR																				
4700	SR.....A472KAR																				
6800	SR.....A682KAR																				
8200	SR.....A822KAR																				
10,000	SR.....A103KAR																				
15,000	SR.....A153KAR																				
22,000	SR.....A223KAR																				
33,000	SR.....A333KAR																				
39,000	SR.....A393KAR																				
47,000	SR.....A473KAR																				
68,000	SR.....A683KAR																				
100,000	SR.....A104KAR																				

For other styles, voltages, tolerances and lead lengths see Part No. Codes or contact factory.

*Other capacitance values available upon special request.

- = Industry preferred values
- = SR20 only

Capacitance ranges available for SR12 and SR07 same as SR15
 SR62 and SR59 same as SR21
 SR64 and SR65 same as SR30
 SR75 same as SR40
 SR13 same as SR21

NOTE: For others voltages, tolerances, electrical specifications and NPO typical characteristics, see the KYOCERA AVX Multilayer Ceramic Leaded Capacitors Catalog.

RADIAL LEADS

X7R Dielectric



SIZE AND CAPACITANCE SPECIFICATIONS

EIA Characteristic

Dimensions: Millimeters (Inches)

	Style	SR15			SR20			SR21			SR22			SR27			SR30			SR40			SR50			
		SR07	SR07	SR07	SR29	SR29	SR29	SR59	SR59	SR59	N/A	N/A	N/A	N/A	N/A	N/A	N/A	SR65	SR65	SR65	SR75	SR75	SR75	N/A	N/A	N/A
	Width (W)	3.81 (.150)	3.81 (.150)	3.81 (.150)	5.08 (.200)	5.08 (.200)	5.08 (.200)	5.08 (.200)	5.08 (.200)	5.08 (.200)	5.08 (.200)	5.08 (.200)	6.604 (.260)	6.604 (.260)	6.604 (.260)	6.604 (.260)	7.62 (.300)	7.62 (.300)	7.62 (.300)	10.16 (.400)	10.16 (.400)	10.16 (.400)	12.70 (.500)	12.70 (.500)	12.70 (.500)	
	Height (H)	3.81 (.150)	3.81 (.150)	3.81 (.150)	5.08 (.200)	5.08 (.200)	5.08 (.200)	5.08 (.200)	5.08 (.200)	5.08 (.200)	5.08 (.200)	5.08 (.200)	6.35 (.250)	6.35 (.250)	6.35 (.250)	6.35 (.250)	7.62 (.300)	7.62 (.300)	7.62 (.300)	10.16 (.400)	10.16 (.400)	10.16 (.400)	12.70 (.500)	12.70 (.500)	12.70 (.500)	
	Thickness (T)	2.54 (.100)	2.54 (.100)	2.54 (.100)	3.175 (.125)	3.175 (.125)	3.175 (.125)	3.175 (.125)	3.175 (.125)	3.175 (.125)	3.175 (.125)	3.175 (.125)	4.06 (.160)	4.06 (.160)	4.06 (.160)	4.06 (.160)	3.81 (.150)	3.81 (.150)	3.81 (.150)	3.81 (.150)	3.81 (.150)	3.81 (.150)	5.08 (.200)	5.08 (.200)	5.08 (.200)	
	Lead Spacing (L.S.)	2.54 (.100)	2.54 (.100)	2.54 (.100)	2.54 (.100)	2.54 (.100)	2.54 (.100)	5.08 (.200)	5.08 (.200)	5.08 (.200)	5.08 (.200)	5.08 (.200)	6.35 (.250)	6.35 (.250)	6.35 (.250)	6.35 (.250)	5.08 (.200)	5.08 (.200)	5.08 (.200)	5.08 (.200)	5.08 (.200)	5.08 (.200)	10.16 (.400)	10.16 (.400)	10.16 (.400)	
	Lead Diameter (L.D.)	.508 (.020)	.508 (.020)	.508 (.020)	.508 (.020)	.508 (.020)	.508 (.020)	.508 (.020)	.508 (.020)	.508 (.020)	.508 (.020)	.508 (.020)	.508 (.020)	.508 (.020)	.508 (.020)	.508 (.020)	.508 (.020)	.508 (.020)	.508 (.020)	.508 (.020)	.508 (.020)	.508 (.020)	.508 (.020)	.635 (.025)	.635 (.025)	
Cap. in.* pF	Industry Preferred Values in Blue	WVDC			WVDC			WVDC			WVDC			WVDC			WVDC			WVDC			WVDC			
		200	100	50	200	100	50	200	100	50	200	100	50	200	100	50	200	100	50	200	100	50	200	100	50	
470	SR...C471KAR																									
1000	SR155C102KAR																									
1500	SR...C152KAR																									
2200	SR...C222KAR																									
3300	SR...C332KAR																									
4700	SR...C472KAR																									
6800	SR...C682KAR																									
10,000	SR215C103KAR																									
15,000	SR...C153KAR																									
22,000	SR...C223KAR																									
33,000	SR...C333KAR																									
47,000	SR...C473KAR																									
68,000	SR...C683KAR																									
100,000	SR215C104KAR																									
150,000	SR...C154KAR																									
220,000	SR215C224KAR																									
330,000	SR...C334KAR																									
390,000	SR...C394KAR																									
470,000	SR305C474KAR																									
1.0 uF	SR305C105KAR																									
2.2 uF	SR405C225KAR																									
2.7 uF	SR505C275KAR																									
4.7 uF	SR505C475KAR																									
10.0 uF	SR655C106KAR																									

For other styles, voltages, tolerances and lead lengths see Part No. Codes or contact factory.

- = Industry preferred values
- = Extended range
- = Extended range with 0.150" thickness maximum

RADIAL LEADS

Z5U Dielectric



SIZE AND CAPACITANCE SPECIFICATIONS

EIA Characteristic

Dimensions: Millimeters (Inches)

Style	SR15	SR20	SR21	SR22	SR27	SR30	SR40	SR50							
"Insertable"	SR07	SR29	SR59	N/A	N/A	SR65	SR75	N/A							
Width (W)	3.81 (.150)	5.08 (.200)	5.08 (.200)	5.08 (.200)	6.604 (.260)	7.62 (.300)	10.16 (.400)	12.70 (.500)							
Height (H)	3.81 (.150)	5.08 (.200)	5.08 (.200)	5.08 (.200)	6.35 (.250)	7.62 (.300)	10.16 (.400)	12.70 (.500)							
Thickness (T)	2.54 (.100)	3.175 (.125)	3.175 (.125)	3.175 (.125)	4.06 (.160)	3.81 (.150)	3.81 (.150)	5.08 (.200)							
Lead Spacing (L.S.)	2.54 (.100)	2.54 (.100)	5.08 (.200)	6.35 (.250)	7.62 (.300)	5.08 (.200)	5.08 (.200)	10.16 (.400)							
Lead Diameter (L.D.)	.508 (.020)	.508 (.020)	.508 (.020)	.508 (.020)	.508 (.020)	.508 (.020)	.508 (.020)	.635 (.025)							
Cap. in.* pF	Industry Preferred Values in Blue	WVDC		WVDC		WVDC		WVDC		WVDC		WVDC		WVDC	
		100	50	100	50	100	50	100	50	100	50	100	50	100	50
10,000	SR155E103ZAR														
47,000	SR.....E473ZAR														
100,000	SR215E104ZAR														
150,000	SR.....E154ZAR														
220,000	SR215E224ZAR														
330,000	SR215E334ZAR														
470,000	SR215E474ZAR														
680,000	SR.....E684ZAR														
1.0 µF	SR.....105ZAR														
1.5 µF	SR30E155ZAR														
2.2 µF	SR30E225ZAR														
3.3 µF	SR30E335ZAR														
4.7 µF	SR30E475ZAR														

For other styles, voltages, tolerances and lead lengths see Part No. Codes or contact factory.

*Other capacitance values available upon special request.

- = Industry preferred values
- = SR20 only

Capacitance ranges available for SR12 and SR07 same as SR15
 SR62 and SR59 same as SR21
 SR64 and SR65 same as SR30
 SR75 same as SR40
 SR13 same as SR21

NOTE: For others voltages, tolerances, electrical specifications and NPO typical characteristics, see the KYOCERA AVX Multilayer Ceramic Leaded Capacitors Catalog.

500 VOLT SKYCAPS**

STYLE*	MAXIMUM CAPACITANCE VALUE	
	C0G (NPO)	X7R
SR29	900 pF	.015 µF
SR20	1800 pF	.033 µF
SR28 SR59	900 pF	.015 µF
SR13 SR21	1800 pF	.033 µF
SR30 SR61 SR65	7200 pF	.12 µF
SR40 SR75	.015 µF	.27 µF
SR22	1800 pF	.033 µF
SR27	1800 pF	.033 µF
SR76	.015 µF	.27 µF

*Consult pages 27 and 28 for style sizes.

**Voltage rating based on DWV of 150% of rated voltage.

RADIAL LEADS

SkyCap®/SL Series

GENERAL INFORMATION

SL Series

Conformally Coated Radial Leaded MLC

Temperature Coefficients: COG (NP0), X7R, Z5U

200, 100, 50 Volts (300V, 400V & 500V also available)

Case Material: Epoxy

Lead Material: Solderable Sn/Pb

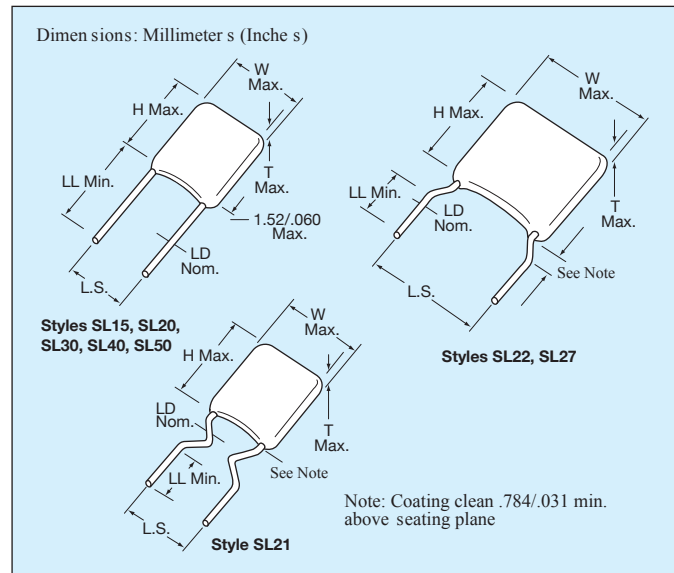

Drawings are for illustrative purposes only. Actual lead form shape could vary within stated tolerances based on body size.

HOW TO ORDER

SL21

5

E

104

M

A

B

TR1

Style

SL15
SL20
SL21
SL22
SL27
SL30
SL40
SL50

Voltage

5 = 50V
1 = 100V
2 = 200V
9 = 300V
8 = 400V
7 = 500V

Temperature Coefficient

A = COG (NP0)
C = X7R
E = Z5U

Capacitance

First two digits are the significant figures of capacitance. Third digit indicates the additional number of zeros. For example, order 100,000 pF as 104. (For values below 10pF use "R" in place of decimal point, e.g., 1R4 = 1.4pF.)

Capacitance Tolerance

COG (NP0):
C = ±.25pF
D = ±.5pF
F = ±1% (>50pF only)
G = ±2% (>25pF only)
J = ±5%
K = ±10%

X7R:
J = ±5%
K = ±10%
M = ±20%

Z5U:
M = ±20%
Z = +80%
-20%

Failure Rate

A = Not Applicable

Leads

B = Leads Sn/Pb Blank: (Tin lead product)

Packaging

Bulk Packaging 1.0" minimum of lead length
T: Trimmed leads .230" ± .030"
Bulk packaging
TR1: Tape and Reel Packaging
AP1: Ammopack packaging

See packaging specification pages 33-34

Not RoHS Compliant

MARKING

FRONT

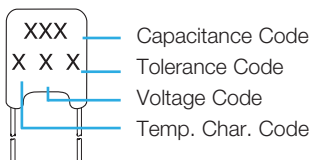

BACK

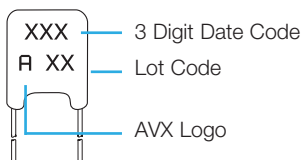

PACKAGING REQUIREMENTS

	Quantity per Bag
SL15, 20, 21, 22, 27, 30	1000 Pieces
SL40, 50	500 Pieces

Note: SL15, SL20, SL21, SL30, and SL40 available on tape and reel per EIA specifications RS-468. See Pages 33 and 34.

RADIAL LEADS

COG (NP0) Dielectric



SIZE AND CAPACITANCE SPECIFICATIONS

EIA Characteristic

Dimensions: Millimeters (Inches)

Style	SL15	SL20	SL21	SL22	SL27	SL30	SL40	SL50
"Insertable"	SL07	SL29	SL59	N/A	N/A	SL65	SL75	N/A
Width (W)	3.81 (.150)	5.08 (.200)	5.08 (.200)	5.08 (.200)	6.604 (.260)	7.62 (.300)	10.16 (.400)	12.70 (.500)
Height (H)	3.81 (.150)	5.08 (.200)	5.08 (.200)	5.08 (.200)	6.35 (.250)	7.62 (.300)	10.16 (.400)	12.70 (.500)
Thickness (T)	2.54 (.100)	3.175 (.125)	3.175 (.125)	3.175 (.125)	4.06 (.160)	3.81 (.150)	3.81 (.150)	5.08 (.200)
Lead Spacing (L.S.)	2.54 (.100)	2.54 (.100)	5.08 (.200)	6.35 (.250)	7.62 (.300)	5.08 (.200)	5.08 (.200)	10.16 (.400)
Lead Diameter (L.D.)	.508 (.020)	.508 (.020)	.508 (.020)	.508 (.020)	.508 (.020)	.508 (.020)	.508 (.020)	.635 (.025)
Cap. in.* pF	Industry Preferred Values in Blue	WVDC	WVDC	WVDC	WVDC	WVDC	WVDC	WVDC
		200 100 50	200 100 50	200 100 50	200 100 50	200 100 50	200 100 50	200 100 50
1.0-9.9	SL151A1R0DAB 10 SL151A100KAB 15 SI.....A150KAB							
22	SL.....A220KAB							
33	SL.....A330KAB							
39	SL.....A390KAB							
47	SL.....A470KAB							
68	SL.....A680KAB							
100 SL151A101KAB								
150	SI.....A151KAB							
220	SI.....A221KAB							
330	SI.....A331KAB							
390	SI.....A391KAB							
470	SI.....A471KAB							
680	SI.....A681KAB							
1000 SL211A102KAB								
1500	SI.....A152KAB							
2200	SI.....A222KAB							
3900	SI.....A392KAB							
4700	SI.....A472KAB							
6800	SI.....A682KAB							
8200	SI.....A822KAB							
10,000 SL305A103KAB								
15,000	SI.....A153KAB							
22,000	SI.....A223KAB							
33,000	SI.....A333KAB							
39,000	SI.....A393KAB							
47,000	SI.....A473KAB							
68,000	SI.....A683KAB							
100,000	SI.....A104KAB							

For other styles, voltages, tolerances and lead lengths see Part No. Codes or contact factory.

*Other capacitance values available upon special request.

- = Industry preferred values
- = SL20 only

NOTE: Capacitance ranges available for
 SL12 same as SL15
 SL62 same as SL21
 SL64 same as SL30
 SL89 same as SL21

RADIAL LEADS

X7R Dielectric





SIZE AND CAPACITANCE SPECIFICATIONS

EIA Characteristic

Dimensions: Millimeters (Inches)

Style	SL15	SL20	SL21	SL22	SL27	SL30	SL40	SL50														
"Insertable"	SL07	SL29	SL59	N/A	N/A	SL65	SL75	N/A														
Width (W)	3.81 (.150)	5.08 (.200)	5.08 (.200)	5.08 (.200)	6.604 (.260)	7.62 (.300)	10.16 (.400)	12.70 (.500)														
Height (H)	3.81 (.150)	5.08 (.200)	5.08 (.200)	5.08 (.200)	6.35 (.250)	7.62 (.300)	10.16 (.400)	12.70 (.500)														
Thickness (T)	2.54 (.100)	3.175 (.125)	3.175 (.125)	3.175 (.125)	4.06 (.160)	3.81 (.150)	3.81 (.150)	5.08 (.200)														
Lead Spacing (L.S.)	2.54 (.100)	2.54 (.100)	5.08 (.200)	6.35 (.250)	7.62 (.300)	5.08 (.200)	5.08 (.200)	10.16 (.400)														
Lead Diameter (L.D.)	.508 (.020)	.508 (.020)	.508 (.020)	.508 (.020)	.508 (.020)	.508 (.020)	.508 (.020)	.635 (.025)														
Cap. in.* Industry Preferred Values in Blue	WVDC			WVDC			WVDC			WVDC			WVDC			WVDC			WVDC			
	200	100	50	200	100	50	200	100	50	200	100	50	200	100	50	200	100	50	200	100	50	
470 SL.....C471KAB																						
1000 SL155C102KAB																						
1500 SL.....C152KAB																						
2200 SL.....C222KAB																						
3300 SL.....C332KAB																						
4700 SL.....C472KAB																						
6800 SL.....C682KAB																						
10,000 SL215C103KAB																						
15,000 SL.....C153KAB																						
22,000 SL.....C223KAB																						
33,000 SL.....C333KAB																						
47,000 SL.....C473KAB																						
68,000 SL.....C683KAB																						
100,000 SL215C104KAB																						
150,000 SL.....C154KAB																						
220,000 SL215C224KAB																						
330,000 SL.....C334KAB																						
390,000 SL.....C394KAB																						
470,000 SL305C474KAB																						
1.0 uF SL305C105KAB																						
2.2 uF SL405C225KAB																						
2.7 uF SL505C275KAB																						
4.7 uF SL505C475KAB																						
10.0 uF SL655C106KAB																						

For other styles, voltages, tolerances and lead lengths see Part No. Codes or contact factory.

-  = Industry preferred values
-  = Extended range
-  = Extended range with 0.150" thickness maximum

RADIAL LEADS

Z5U Dielectric



SIZE AND CAPACITANCE SPECIFICATIONS

EIA Characteristic

Dimensions: Millimeters (Inches)

Style	SL15	SL20	SL21	SL22	SL27	SL30	SL40	SL50							
"Insertable"	SL07	SL29	SL59	N/A	N/A	SL65	SL75	N/A							
Width (W)	3.81 (.150)	5.08 (.200)	5.08 (.200)	5.08 (.200)	6.604 (.260)	7.62 (.300)	10.16 (.400)	12.70 (.500)							
Height (H)	3.81 (.150)	5.08 (.200)	5.08 (.200)	5.08 (.200)	6.35 (.250)	7.62 (.300)	10.16 (.400)	12.70 (.500)							
Thickness (T)	2.54 (.100)	3.175 (.125)	3.175 (.125)	3.175 (.125)	4.06 (.160)	3.81 (.150)	3.81 (.150)	5.08 (.200)							
Lead Spacing (L.S.)	2.54 (.100)	2.54 (.100)	5.08 (.200)	6.35 (.250)	7.62 (.300)	5.08 (.200)	5.08 (.200)	10.16 (.400)							
Lead Diameter (L.D.)	.508 (.020)	.508 (.020)	.508 (.020)	.508 (.020)	.508 (.020)	.508 (.020)	.508 (.020)	.635 (.025)							
Cap. in.*	Industry Preferred Values in Blue	WVDC		WVDC		WVDC		WVDC		WVDC		WVDC		WVDC	
pF		100	50	100	50	100	50	100	50	100	50	100	50	100	50
10,000	SL155E103ZAB														
47,000	SL.....E473ZAB														
100,000	SL215E104ZAB														
150,000	SL.....E154ZAB														
220,000	SL215E224ZAB														
330,000	SL215E334ZAB														
470,000	SL215E474ZAB														
680,000	SL.....E684ZAB														
1.0 µF	SL.....105ZAB														
1.5 µF	SL30E155ZAB														
2.2 µF	SL30E225ZAB														
3.3 µF	SL30E335ZAB														
4.7 µF	SL30E475ZAB														

For other styles, voltages, tolerances and lead lengths see Part No. Codes or contact factory.

*Other capacitance values available upon special request.

- = Industry preferred values
- = SL20 only

500 VOLT SKYCAPS**

STYLE*	MAXIMUM CAPACITANCE VALUE	
	COG (NP0)	X7R
SL29	900 pF	.015 µF
SL20	1800 pF	.033 µF
SL28	900 pF	.015 µF
SL59		
SL13	1800 pF	.033 µF
SL21		
SL30	7200 pF	.12 µF
SL61		
SL65		
SL40	.015 µF	.27 µF
SL75		
SL22	1800 pF	.033 µF
SL27	1800 pF	.033 µF
SL76	.015 µF	.27 µF
SL50	.036 µF	.59 µF

*Consult pages 27 and 28 for style sizes.

**Voltage rating based on DWV of 150% of rated voltage.



The Important Information/Disclaimer is incorporated in the catalog where these specifications came from or available online at www.avx.com/disclaimer/ by reference and should be reviewed in full before placing any order.

RADIAL LEADS

SkyCap®/AR Series – Automotive

GENERAL INFORMATION

AR Series

Conformally Coated Radial Leaded MLC

Temperature Coefficients: C0G (NP0), X7R, X8R

3000, 2000, 1000, 200, 100, 50 Volts

Case Material: Epoxy

Lead Material: RoHS Compliant, 100% Tin

Qualified: to AEC-Q200, PPAP Available

Temperature Range: up to 150°C

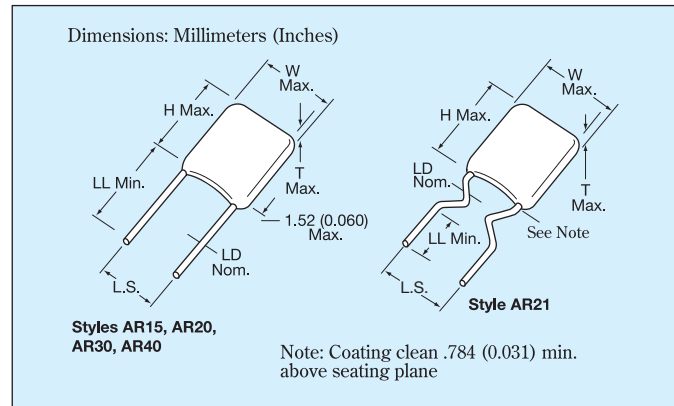

Drawings are for illustrative purposes only.
Actual lead form shape could vary within stated tolerances based on body size.

HOW TO ORDER

AR21

Style

5

Voltage
5 = 50V
1 = 100V
2 = 200V
A = 1000V
G = 2000V
H = 3000V

F

Temperature Coefficient
A = C0G (NP0)
C = X7R
F = X8R
L = X8L

104

Capacitance
First two digits are the significant figures of capacitance. Third digit indicates the additional number of zeros. For example, order 100,000 pF as 104. (For values below 10pF use "R" in place of decimal point, e.g., 1R4 = 1.4pF.)

M

Capacitance Tolerance

C0G (NP0):
C = ±.25pF
D = ±.5pF
F = ±1% (>50pF only)
G = ±2% (>25pF only)
J = ±5%
K = ±10%

X7R:
J = ±5%
K = ±10%
M = ±20%

X8R:
J = ±5%
K = ±10%
M = ±20%

4

Failure Rate
4 = AEC-Q200

R

Leads
R = RoHS

TR1

Packaging

Blank: Bulk Packaging 1.0" minimum of lead length
T: Trimmed leads .230" ± .030"
Bulk packaging
TR1: Tape and Reel Packaging
AP1: Ammopack packaging

See packaging specification pages 33-34



MARKING

FRONT

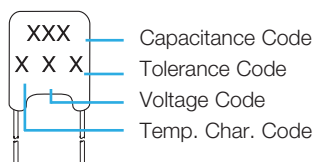

BACK

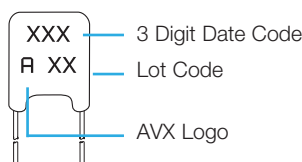

PACKAGING REQUIREMENTS

	Quantity per Bag
AR15, 20, 21, 30	1000 Pieces
AR40	500 Pieces

Note: AR15, AR20, AR21, AR30, and AR40 available on tape and reel per EIA specifications RS-468. See pages 33 and 34.

RADIAL LEADS

COG (NP0) Dielectric

SIZE AND CAPACITANCE SPECIFICATIONS

EIA Characteristic

Dimensions: Millimeters (Inches)

Style		AR15	AR20	AR21						
"Insertable"		AR07	AR29	AR59						
Width (W)		3.81 (.150)	5.08 (.200)	5.08 (.200)						
Height (H)		3.81 (.150)	5.08 (.200)	5.08 (.200)						
Thickness (T)		2.54 (.100)	3.175 (.125)	3.175 (.125)						
Lead Spacing (L.S.)		2.54 (.100)	2.54 (.100)	5.08 (.200)						
Lead Diameter (L.D.)		.508 (.020)	.508 (.020)	.508 (.020)						
Cap. in. pF	Industry Preferred Values in Blue	WVDC			WVDC			WVDC		
		200	100	50	200	100	50	200	100	50
1	AR----A1R0D4R									
10	AR----A100K4R									
15	AR----A150K4R									
22	AR----A220K4R									
33	AR----A330K4R									
39	AR----A390K4R									
47	AR----A470K4R									
68	AR----A680K4R									
100	AR----A101K4R									
150	AR----A151K4R									
220	AR----A221K4R									
330	AR----A331K4R									
390	AR----A391K4R									
470	AR----A471K4R									
680	AR----A681K4R									
1,000	AR----A102K4R									
1,500	AR----A152K4R									
2,200	AR----A222K4R									
3,900	AR----A392K4R									
4,700	AR----A472K4R									
6800	AR----A682K4R									
8200	AR----A822K4R									

Notes:

"Insertable" make reference to alternative KYOCERA AVX style using the same range of capacitance available on the matrix.

For others Styles, voltages, tolerance and lead lengths see Skycap catalog or contact factory.

Others capacitance values available upon special request.

Others styles available: AR12, AR14, AR62, AR89.

RADIAL LEADS

X7R Dielectric



SIZE AND CAPACITANCE SPECIFICATIONS

EIA Characteristic

Dimensions: Millimeters (Inches)

Style		AR15	AR20	AR21	AR30	AR40	
"Insertable"		AR07	AR29	AR59	AR65	AR75	
Width (W)		3.81 (.150)	5.08 (.200)	5.08 (.200)	7.62 (.300)	10.16 (.400)	
Height (H)		3.81 (.150)	5.08 (.200)	5.08 (.200)	7.62 (.300)	10.16 (.400)	
Thickness (T)		2.54 (.100)	3.175 (.125)	3.175 (.125)	3.81 (.150)	3.81 (.150)	
Lead Spacing (L.S.)		2.54 (.100)	2.54 (.100)	5.08 (.200)	5.08 (.200)	5.08 (.200)	
Lead Diameter (L.D.)		.508 (.020)	.508 (.020)	.508 (.020)	.508 (.020)	.508 (.020)	
Cap. in. pF	Industry Preferred Values in Blue	WVDC		WVDC		WVDC	
		100	50	100	50	100	50
470	AR----C471K4R						
1000	AR----C102K4R						
1500	AR----C152K4R						
2200	AR----C222K4R						
3300	AR----C332K4R						
4700	AR----C472K4R						
6800	AR----C682K4R						
10,000	AR----C103K4R						
15,000	AR----C153K4R						
22,000	AR----C223K4R						
33,000	AR----C333K4R						
47,000	AR----C473K4R						
68,000	AR----C683K4R						
100,000	AR----C104K4R						
150,000	AR----C154K4R						
220,000	AR----C224K4R						
330,000	AR----C334K4R						
390,000	AR----C394K4R						
470,000	AR----C474K4R						
680,000	AR----C684K4R						
1.0 uF	AR----C105K4R						
4,700,000	AR----C475K4R						
6,800,000	AR----C685K4R						
10.0 uF	AR----C106K4R						

= Extended range with 0.150" thickness maximum

Notes:

"Insertable" make reference to alternative KYOCERA AVX style using the same range of capacitance available on the matrix.

For others Styles, voltages, tolerance and lead lengths see Skycap catalog or contact factory.

Others capacitance values available upon special request.

Others styles available: AR12, AR14, AR62, AR89, AR32, AR38.

RADIAL LEADS

X8R Dielectric "F"

GENERAL INFORMATION

AR Series

Conformally Coated Radial Leaded MLC

Temperature Coefficients: C0G (NP0), X7R, X8R

200, 100, 50 Volts

Case Material: Epoxy

Lead Material: Solderable

Qualified: to AEC-Q200

Temperature Range: up to 150°C

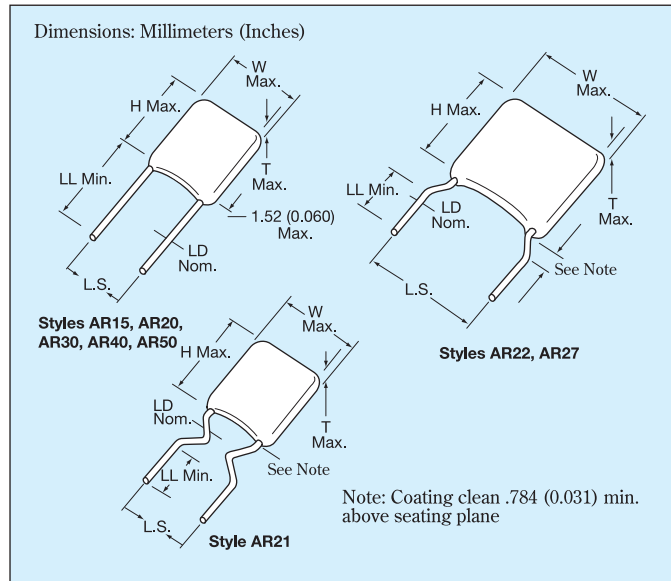

Drawings are for illustrative purposes only. Actual lead form shape could vary within stated tolerances based on body size.

HOW TO ORDER

AR21

5

F

104

M

4

R

TR1

Style

Voltage

5 = 50V
1 = 100V
2 = 200V

Temperature Coefficient

F = X8R

Capacitance

First two digits are the significant figures of capacitance. Third digit indicates the additional number of zeros. For example, order 100,000 pF as 104. (For values below 10pF use "R" in place of decimal point, e.g., 1R4 = 1.4pF.)

Capacitance Tolerance

X8R:
J = ±5%
K = ±10%
M = ±20%

Failure Rate

4 = AEC-Q200

Leads

R = RoHS

Packaging

Blank: Bulk Packaging 1.0" minimum of lead length
T: Trimmed leads .230" ± .030"
Bulk packaging
TR1: Tape and Reel Packaging
AP1: Ammopack packaging

See packaging specification pages 33-34

MARKING

FRONT

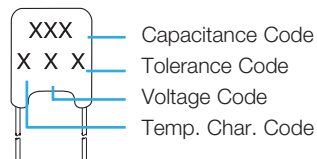

BACK

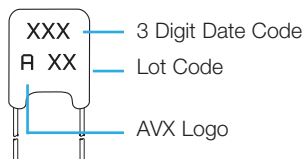

PACKAGING REQUIREMENTS

	Quantity per Bag
AR15, 20, 21, 30	1000 Pieces
AR40	500 Pieces

Note: AR15, AR20, AR21, AR30, and AR40 available on tape and reel per EIA specifications RS-468. See pages 33 and 34.



RADIAL LEADS

X8R Dielectric

SIZE AND CAPACITANCE SPECIFICATIONS

EIA Characteristic Dimensions: Millimeters (Inches)

Style		AR20			AR21		
"Insertable"		AR29			AR59		
Width (W)		5.08 (.200)			5.08 (.200)		
Height (H)		5.08 (.200)			5.08 (.200)		
Thickness (T)		3.175 (.125)			3.175 (.125)		
Lead Spacing (L.S.)		2.54 (.100)			5.08 (.200)		
Lead Diameter (L.D.)		.508 (.020)			.508 (.020)		
Cap. in. pF	Industry Preferred Values in Blue	WVDC			WVDC		
		200	100	50	200	100	50
1,000	AR----F102K4R						
10,000	AR----F103K4R						
100,000	AR----F104K4R						
330,000	AR----F334K4R						

Notes:

"Insertable" make reference to alternative KYOCERA AVX style using the same range of capacitance available on the matrix. For others Styles, voltages, tolerance and lead lengths see Skycap catalog or contact factory. Others capacitance values available upon special request. Others styles available: AR14, AR62, AR89.

RADIAL LEADS

X8L Dielectric



STYLES AND CAPACITANCE SPECIFICATIONS

EIA Characteristics

Style		AR15		AR20		AR21	
"Insertable"		AR07		AR29		AR59	
Cap. in pF	Industry Preferred Values	WVDC		WVDC		WVDC	
		100	50	100	50	100	50
470	AR____L471K4R						
1,000	AR____L102K4R						
1,500	AR____L152K4R						
2,200	AR____L222K4R						
3,300	AR____L332K4R						
4,700	AR____L472K4R						
6,800	AR____L682K4R						
10,000	AR____L103K4R						
15,000	AR____L153K4R						
22,000	AR____L223K4R						
33,000	AR____L333K4R						
47,000	AR____L473K4R						
68,000	AR____L683K4R						
100,000	AR____L104K4R						
150,000	AR____L154K4R						
220,000	AR____L224K4R						
330,000	AR____L334K4R						
390,000	AR____L394K4R						
470,000	AR____L474K4R						
680,000	AR____L684K4R						
1.0 uF	AR____L105K4R						
4700,000	AR____L475K4R						
6800,000	AR____L685K4R						
10.0 uF	AR____L106K4R						

RADIAL LEADS

High Voltage Automotive Product SkyCap Capacitors - X7R Dielectric

SIZE AND CAPACITANCE SPECIFICATIONS

EIA Characteristic Dimensions: Millimeters (Inches)

Cap. in. pF	Style	AR20	AR21	AR22	AR27	AR30	
	"Insertable"	AR29	AR59	N/A	N/A	AR65	
Industry Preferred Values in Blue	WVDC 1000	WVDC 1000	WVDC 1000	WVDC 1000	WVDC 1000	WVDC	
						2000	3000
470	AR____C471K4R						
1000	AR____C102K4R						
1500	AR____C152K4R						
2200	AR____C222K4R						
3300	AR____C332K4R						
4700	AR____C472K4R						
6800	AR____C682K4R						
10,000	AR____C103K4R						
15,000	AR____C153K4R						
22,000	AR____C223K4R						
47,000	AR____C473K4R						
68,000	AR____C683K4R						

For others Styles, voltages, tolerance and lead lengths see Skycap catalog or contact factory.

RADIAL LEADS

SkyCap® Configurations by Lead Spacing

LEAD SPACING .100 ±.030				Dimensions: Inches (Millimeters)			
<p>AR07/SR07* (T=.100)</p> <p>.150 (3.81) Max. .250 (6.35) Max. .050 (1.27) Clean Above Seating Plane 1.0 (25.4) Min. .100 (2.54) .030</p>	<p>AR14/SR14 (T=.100)</p> <p>.200 (5.08) Max. .300 (7.62) Max. Meniscus Free .031 (.787) Above Seating Plane .230 (5.84) .030 .100 (2.54) .030</p>	<p>AR15/SR15* (T=.100)</p> <p>.150 (3.81) Max. .150 (3.81) Max. 1.0 (25.4) Min. .060 (1.52) Max. .100 (2.54) .030</p>	<p>AR20/SR20* (T=.125)</p> <p>.200 (5.08) Max. .200 (5.08) Max. 1.0 (25.4) Min. .060 (1.52) Max. .100 (2.54) .030</p>	<p>AR29/SR29* (T=.125)</p> <p>.200 (5.08) Max. .250 (6.35) Max. Meniscus Free .031 (.787) Above Seating Plane 1.0 (25.4) Min. .100 (2.54) .030</p>	<p>AR62/SR62* (T=.125)</p> <p>.210 (5.33) Max. .358 (9.09) Max. 0.008 0.002 (.203 .051) 0.040 (1.016) Min. 0.100 .031 (2.54 .787)</p> <p>Leads = #22 AWG</p>	<p>SR62-LP* (T=.100)</p> <p>.170 (4.32) Max. 0.04 (1.02) .271 (6.88) Max. 1.0 (25.4) Min. .100 (2.54) .030</p> <p>Leads = #22 AWG</p>	

LEAD SPACING .200 ±.030					Dimensions: Inches (Millimeters)									
<p>AR12/SR12* (T=.100)</p> <p>.150 (3.81) Max. .230 (5.84) Max. 1.0 (25.4) Min. .200 (5.08) .030</p>	<p>SR13* (T=.125)</p> <p>.200 (5.08) Max. .350 (8.89) Max. Meniscus Free .031 (.787) Above Seating Plane 1.0 (25.4) Min. .200 (5.08) .030</p>	<p>AR21/SR21* (T=.125)</p> <p>.200 (5.08) Max. .300 (7.62) Max. .031 (.787) Clean Above Seat 1.0 (25.4) Min. .200 (5.08) .030</p>	<p>SR21-85* (T=.125)</p> <p>.200 (5.08) Max. .300 (7.62) Max. Meniscus Free .031 (.787) Above Seating Plane 1.0 (25.4) Min. .200 (5.08) .030</p>	<p>SR28* (T=.125)</p> <p>.200 (5.08) Max. .250 (6.35) Max. Meniscus Free .031 (.787) Above Seating Plane 1.0 (25.4) Min. .200 (5.08) .030</p>	<p>AR30/SR30* (T=.150)</p> <p>.300 (7.62) Max. .300 (7.62) Max. .060 (1.52) Max. 1.0 (25.4) Min. .200 (5.08) .030</p>	<p>SR30-LP* (T=.150)</p> <p>.300 (7.62) Max. .225 (5.71) Max. .059 (1.5) Max. 1.0 (25.4) Min. .200 (5.08) .030</p>	<p>AR32/SR32* (T=.150)</p> <p>.300 (7.62) Max. .390 (9.91) Max. Meniscus Free .031 (.787) Above Seating Plane 1.0 (25.4) Min. .200 (5.08) .030</p>	<p>AR40/SR40* (T=.150)</p> <p>.400 (10.16) Max. .400 (10.16) Max. .060 (1.52) Max. 1.0 (25.4) Min. .200 (5.08) .030</p>	<p>AR59/SR59* (T=.125)</p> <p>.200 (5.08) Max. .300 (7.62) Max. .031 (.787) Clean Above Seat 1.0 (25.4) Min. .200 (5.08) .030</p>	<p>SR61 (T=.150)</p> <p>.300 (7.62) Max. .500 (12.7) Max. Meniscus Free .031 (.787) Above Seating Plane .230 (5.84) .030 .200 (5.08) .030</p>	<p>SR63* (T=.150)</p> <p>.300 (7.62) Max. .500 (12.7) Max. .137, .196 (3.48/4.98) 1.0 (25.4) Min. .200 (5.08) .030</p>	<p>SR64* (T=.150)</p> <p>.300 (7.62) Max. .500 (12.7) Max. 0.040 (1.02) Min. 1.0 (25.4) Min. .200 (5.08) .030 a = .009 .002 (.229 .051)</p> <p>Leads = #22 AWG</p>	<p>SR64-LP* (T=.150)</p> <p>.268 (6.81) Max. .330 (8.38) Max. 0.04 (1.02) 1.0 (25.4) Min. .200 (5.08) .030</p> <p>Leads = #22 AWG</p>	<p>AR65/SR65* (T=.150)</p> <p>.300 (7.62) Max. .400 (10.16) Max. .300 (7.62) Max. 1.0 (25.4) Min. .200 (5.08) .030</p>

*SL style available in all SR configurations.

RADIAL LEADS

SkyCap® Configurations by Lead Spacing

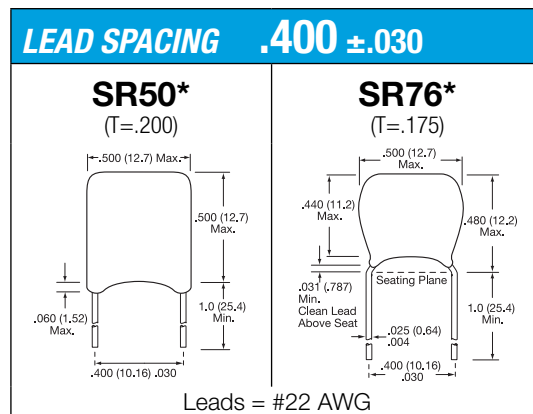
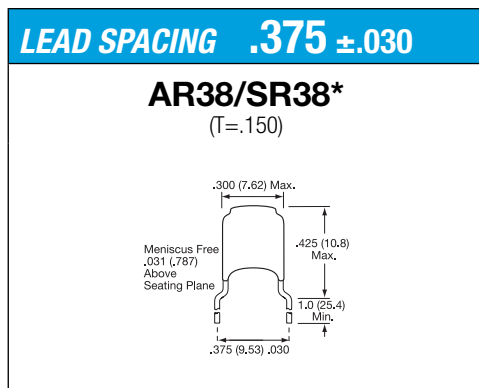
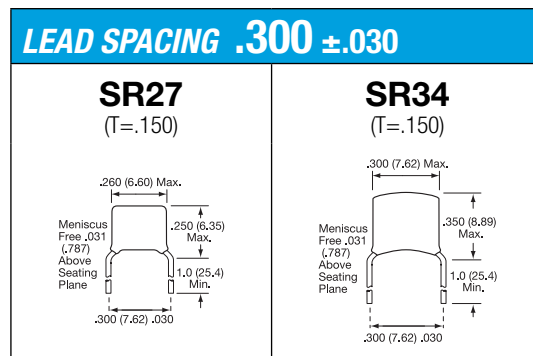
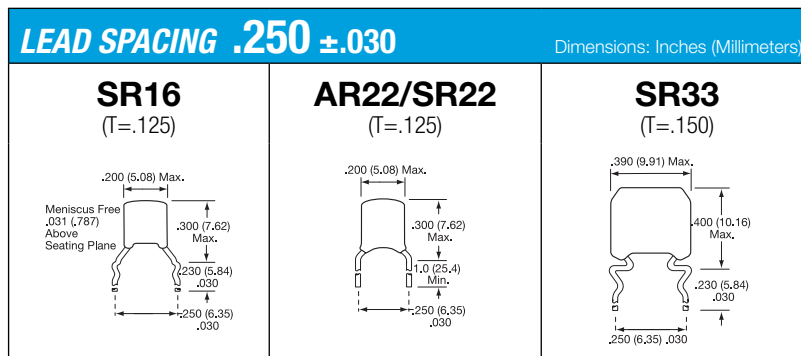
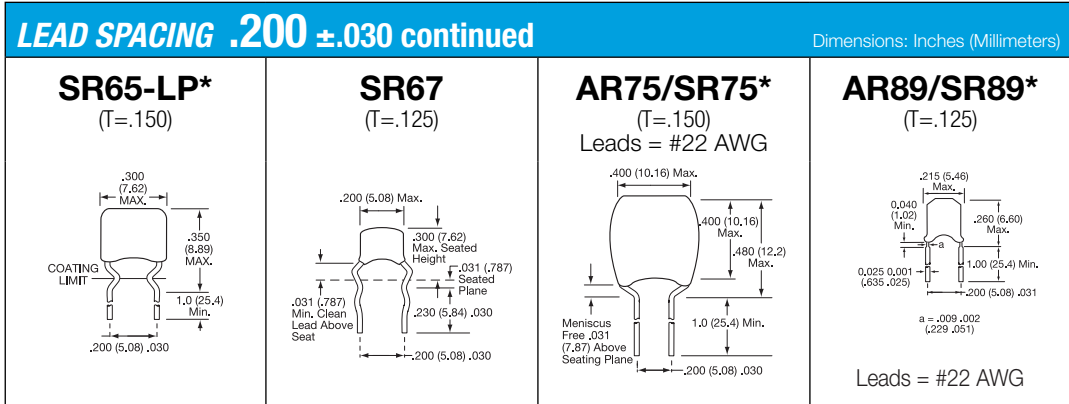

- NOTES:**
1. All leads are #24 AWG unless otherwise noted.
 2. Available in tape and reel packaging(*).
 3. Other styles are also available, contact factory.
 4. (T = XXX) under type designation is maximum thickness in inches.

Drawings are for illustrative purposes only.
Actual lead form shape could vary within stated tolerances based on body size.

*SL style available in all SR configurations.

RADIAL LEADS

Ceramam®

GENERAL INFORMATION

MR Series

Molded Radial Leaded MLC

Temperature Coefficients: COG (NP0), X7R, Z5U
50, 100, 200 Volts

Case Material: Molded Epoxy

Lead Material: Solderable

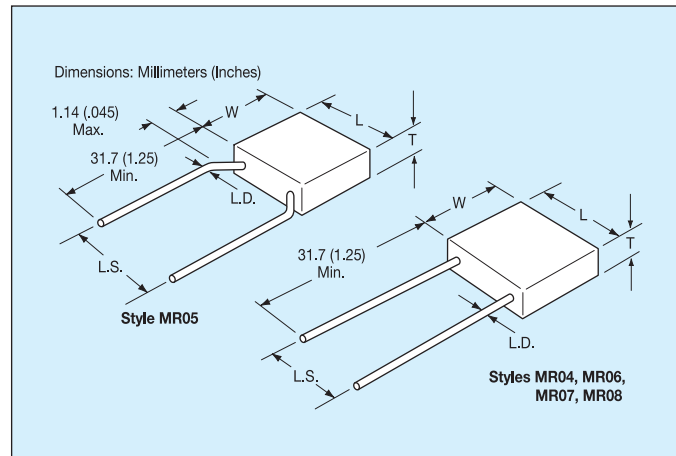

HOW TO ORDER

MR05

1

A

561

J

A

R

Style

MR04
MR05
MR06
MR07
MR08

Voltage

5 = 50V
1 = 100V
2 = 200V

Dielectric

A = COG (NP0)
C = X7R
E = Z5U

Capacitance

First two digits are the significant figures of capacitance. Third digit indicates the additional number of zeros. For example, order 100,000 pF as 104. (For values below 10pF use "R" in place of decimal point, e.g., 1R4 = 1.4pF.)

Capacitance Tolerance

COG (NP0):
D = ±.5pF
(>10pF only)
F = ±1%
(>50pF only)
G = ±2%
(>25pF only)
J = ±5%
K = ±10%

X7R:
J = ±5%
K = ±10%
M = ±20%

Z5U:
M = ±20%
Z = +80%
-20%

Failure Rate

A = Not Applicable
T = CECC

Leads

A = Standard Solderable (SnPb)
T¹ = Trimmed Leads
.230" ± .030"

Not RoHS Compliant

¹ Trimmed lead length for the MR05 style will be measured from the bend in the lead (seating plane).

MARKING

Marking is as size permits.
(For code identification, see HOW TO ORDER section.)

- KYOCERA AVX
- Capacitance Tolerance
- Voltage Rating
- Temperature Coefficient
- Date Code
- Lot Code

PACKAGING REQUIREMENTS

Bulk Packaging: 1000 pcs. per sealed package except MR07/MR08 (300 pcs.).

Tape and Reel: Available on MR04, MR05, and MR06 only (2500 pcs./reel).

Ammo Packaging: Available on special request.

RADIAL LEADS

Ceramam® - COG (NP0)



SIZE AND CAPACITANCE SPECIFICATIONS

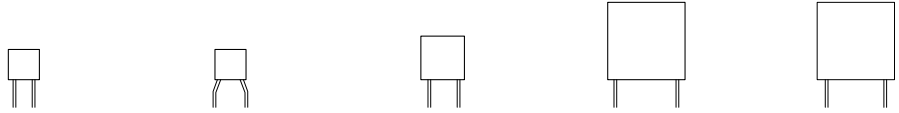

Dimensions: Millimeters (Inches)

Style		MR04			MR05			MR06			MR07			MR08		
Length		4.83 (.190")			4.83 (.190")			7.36 (.290")			12.44 (.490")			12.44 (.490")		
Width		4.83 (.190")			4.83 (.190")			7.36 (.290")			12.44 (.490")			12.44 (.490")		
Thickness		2.28 (.090")			2.28 (.090")			2.28 (.090")			3.55 (.140")			6.09 (.240")		
Lead Spacing		2.54 (.100")			5.08 (.200")			5.08 (.200")			10.16 (.400")			10.16 (.400")		
Lead Diameter		.635 (.025")			.635 (.025")			.635 (.025")			.635 (.025")			.635 (.025")		
Cap.in. pF	Typical Part Nos.	WVDC			WVDC			WVDC			WVDC			WVDC		
		200	100	50	200	100	50	200	100	50	200	100	50	200	100	50
1.0	MR.....5A1R0DAA															
to																
9.1	MR.....5A9R1DAA															
10	MR.....5A100KAA															
12	MR.....5A120KAA															
15	MR.....5A150KAA															
18	MR.....5A180KAA															
22	MR.....5A220KAA															
27	MR.....5A270KAA															
33	MR.....5A330KAA															
39	MR.....5A390KAA															
47	MR.....5A470KAA															
56	MR.....5A560KAA															
68	MR.....5A680KAA															
82	MR.....5A820KAA															
100	MR.....5A101KAA															
120	MR.....5A121KAA															
150	MR.....5A151KAA															
180	MR.....5A181KAA															
220	MR.....5A221KAA															
270	MR.....5A271KAA															
330	MR.....5A331KAA															
390	MR.....5A391KAA															
470	MR.....5A471KAA															
560	MR.....5A561KAA															
680	MR.....5A681KAA															
820	MR.....5A821KAA															
1000	MR.....5A102KAA															
1200	MR.....5A122KAA															
1500	MR.....5A152KAA															
1800	MR.....5A182KAA															
2200	MR.....5A222KAA															
2700	MR.....5A272KAA															
3300	MR.....5A332KAA															
3900	MR.....5A392KAA															
4700	MR.....5A472KAA															
5600	MR.....5A562KAA															
6800	MR.....5A682KAA															
8200	MR.....5A822KAA															
10,000	MR.....5A103KAA															
12,000	MR.....5A123KAA															
15,000	MR.....5A153KAA															
18,000	MR.....5A183KAA															
22,000	MR.....5A223KAA															
27,000	MR.....5A273KAA															
33,000	MR.....5A333KAA															
39,000	MR.....5A393KAA															
47,000	MR.....5A473KAA															
56,000	MR.....5A563KAA															
68,000	MR.....5A683KAA															
82,000	MR.....5A823KAA															
100,000	MR.....5A104KAA															
120,000	MR.....5A124KAA															
150,000	MR.....5A154KAA															

For trimmed leads see "How To Order".
 For other tolerances see "How To Order".
 For other voltages see "How To Order".

= Industry preferred values

*Length, width and thickness dimensions are ±.254 mm (±.010"). Lead diameter is ±.05 mm (±.002"). Lead spacing is ±.381 mm (±.015").

RADIAL LEADS

Ceramam® - X7R



SIZE AND CAPACITANCE SPECIFICATIONS

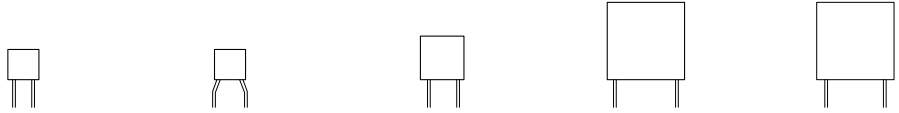

Dimensions: Millimeters (Inches)

Style		MR04	MR05	MR06	MR07	MR08							
Length		4.83 (.190")	4.83 (.190")	7.36 (.290")	12.44 (.490")	12.44 (.490")							
Width		4.83 (.190")	4.83 (.190")	7.36 (.290")	12.44 (.490")	12.44 (.490")							
Thickness		2.28 (.090")	2.28 (.090")	2.28 (.090")	3.55 (.140")	6.09 (.240")							
Lead Spacing		2.54 (.100")	5.08 (.200")	5.08 (.200")	10.16 (.400")	10.16 (.400")							
Lead Diameter		.635 (.025")	.635 (.025")	.635 (.025")	.635 (.025")	.635 (.025")							
Cap. in. pF	Typical Part Nos.	WVDC			WVDC			WVDC			WVDC		
		200	100	50	200	100	50	200	100	50	200	100	50
100	MR.....5C101KAA												
120	MR.....5C121KAA												
150	MR.....5C151KAA												
180	MR.....5C181KAA												
220	MR.....5C221KAA												
270	MR.....5C271KAA												
330	MR.....5C331KAA												
390	MR.....5C391KAA												
470	MR.....5C471KAA												
560	MR.....5C561KAA												
680	MR.....5C681KAA												
820	MR.....5C821KAA												
1000	MR.....5C102KAA												
1200	MR.....5C122KAA												
1500	MR.....5C152KAA												
1800	MR.....5C182KAA												
2200	MR.....5C222KAA												
2700	MR.....5C272KAA												
3300	MR.....5C332KAA												
3900	MR.....5C392KAA												
4700	MR.....5C472KAA												
5600	MR.....5C562KAA												
6800	MR.....5C682KAA												
8200	MR.....5C822KAA												
10,000	MR.....5C103KAA												
12,000	MR.....5C123KAA												
15,000	MR.....5C153KAA												
18,000	MR.....5C183KAA												
22,000	MR.....5C223KAA												
27,000	MR.....5C273KAA												
33,000	MR.....5C333KAA												
39,000	MR.....5C393KAA												
47,000	MR.....5C473KAA												
56,000	MR.....5C563KAA												
68,000	MR.....5C683KAA												
82,000	MR.....5C823KAA												
100,000	MR.....5C104KAA												
120,000	MR.....5C124KAA												
150,000	MR.....5C154KAA												
180,000	MR.....5C184KAA												
220,000	MR.....5C224KAA												
270,000	MR.....5C274KAA												
330,000	MR.....5C334KAA												
390,000	MR.....5C394KAA												
470,000	MR.....5C474KAA												
560,000	MR.....5C564KAA												
680,000	MR.....5C684KAA												
820,000	MR.....5C824KAA												
1.0 pF	MR.....5C105KAA												
1.2 pF	MR.....5C125KAA												
1.5 pF	MR.....5C155KAA												
1.8 pF	MR.....5C185KAA												
2.0 pF	MR.....5C205KAA												
2.2 pF	MR.....5C225KAA												
2.7 pF	MR.....5C275KAA												
3.3 pF	MR.....5C335KAA												
3.9 pF	MR.....5C395KAA												
4.7 pF	MR.....5C475KAA												

For trimmed leads see "How To Order".
For other tolerances see "How To Order".
For other voltages see "How To Order".

= Industry preferred values

*Length, width and thickness dimensions are ±.254 mm (±.010"). Lead diameter is ±.05 mm (±.002"). Lead spacing is ±.381 mm (±.015").



The Important Information/Disclaimer is incorporated in the catalog where these specifications came from or available online at www.avx.com/disclaimer/ by reference and should be reviewed in full before placing any order.

RADIAL LEADS

Ceramam® - Z5U



SIZE AND CAPACITANCE SPECIFICATIONS

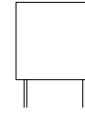
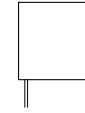

Dimensions: Millimeters (Inches)

Style		MR04		MR05		MR06		MR07		MR08	
		100	50	100	50	100	50	100	50	100	50
Length*		4.83 (.190")		4.83 (.190")		7.36 (.290")		12.44 (.490")		12.44 (.490")	
Width*		4.83 (.190")		4.83 (.190")		7.36 (.290")		12.44 (.490")		12.44 (.490")	
Thickness*		2.28 (.090")		2.28 (.090")		2.28 (.090")		3.55 (.140")		6.09 (.240")	
Lead* Spacing		2.54 (.100")		5.08 (.200")		5.08 (.200")		10.16 (.400")		10.16 (.400")	
Lead* Diameter		.635 (.025")		.635 (.025")		.635 (.025")		.635 (.025")		.635 (.025")	
Cap. in. pF	Typical Part Nos.	WVDC		WVDC		WVDC		WVDC		WVDC	
10,000	MR-----5E103ZAA										
12,000	MR-----5F1237AA										
15,000	MR-----5F1537AA										
18,000	MR-----5F1837AA										
22,000	MR-----5F2237AA										
27,000	MR-----5F2737AA										
33,000	MR-----5F3337AA										
39,000	MR-----5F3937AA										
47,000	MR-----5F4737AA										
56,000	MR-----5F5637AA										
68,000	MR-----5F6837AA										
82,000	MR-----5F8237AA										
100,000	MR-----5E104ZAA										
120,000	MR-----5F1247AA										
150,000	MR-----5F1547AA										
180,000	MR-----5F1847AA										
220,000	MR-----5F2247AA										
270,000	MR-----5F2747AA										
330,000	MR-----5F3347AA										
390,000	MR-----5F3947AA										
470,000	MR-----5E474ZAA										
560,000	MR-----5F5647AA										
680,000	MR-----5F6847AA										
820,000	MR-----5F8247AA										
1.0 µF	MR-----5E105ZAA										
1.2 µF	MR-----5F1257AA										
1.5 µF	MR-----5F1557AA										
1.8 µF	MR-----5F1857AA										
2.2 µF	MR-----5F2257AA										
2.7 µF	MR-----5F2757AA										
3.3 µF	MR-----5F3357AA										
3.9 µF	MR-----5F3957AA										
4.7 µF	MR-----5E475ZAA										
5.6 µF	MR-----5F5657AA										
6.8 µF	MR-----5F6857AA										
8.2 µF	MR-----5F8257AA										
10.0 µF	MR-----5E106ZAA										

For trimmed leads see "How To Order".
 For other tolerances see "How To Order".
 For other voltages see "How To Order".

= Industry preferred values

*Length, width and thickness dimensions are ±.254 mm (±.010"). Lead diameter is ±.05 mm (±.002"). Lead spacing is ±.381 mm (±.015).

RADIAL LEADS

Packaging - Tape and Reel

GENERAL INFORMATION

- Standard reel diameter is 355 millimeters (14 inches) maximum.
- Reeling standard (#1 or #2) should be specified when ordering.

HOW TO ORDER

To specify tape and reel packaging, add TR1, TR2 or TRX to the end of the KYOCERA AVX 12 digit part number.

Examples:

SR215C104KARTR1
SR305E105MARTR2
SR215C103JARTRX

THE INSERTABLES

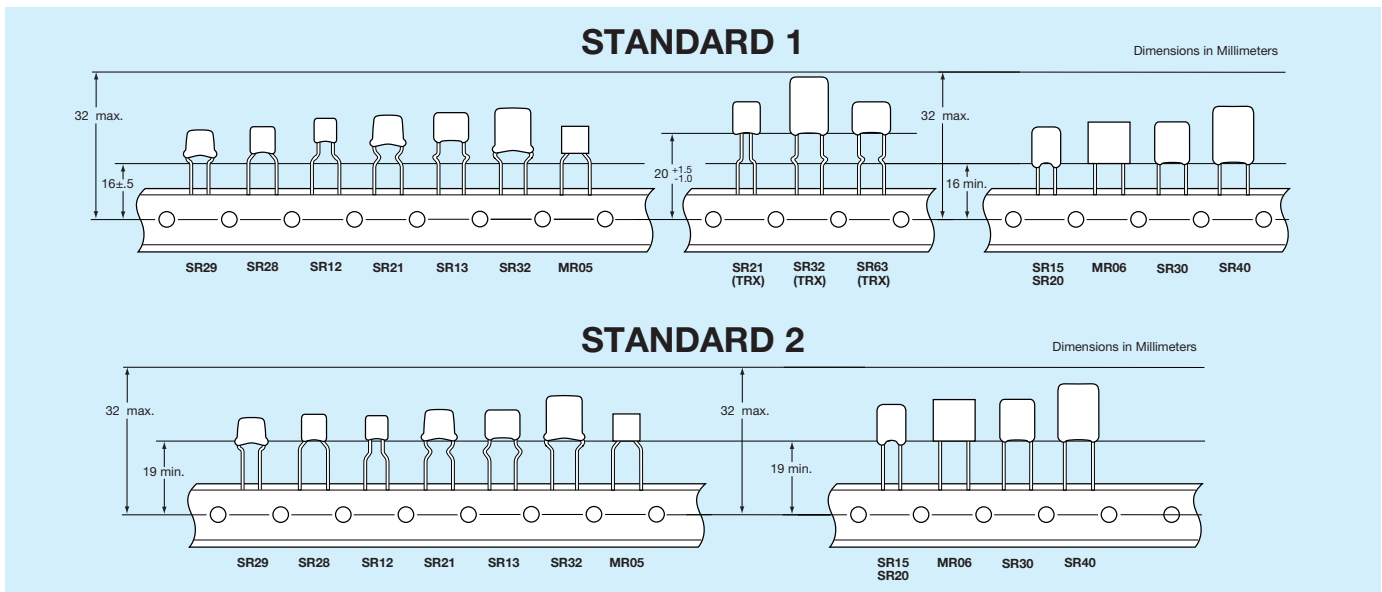
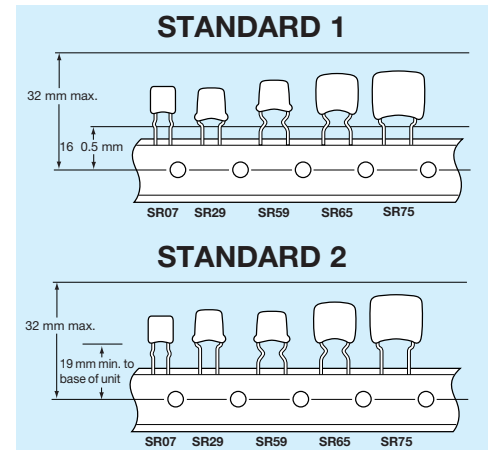

DESCRIPTION

DIMENSIONS (MM)

A. Feed Hole Pitch	12.70 ± .20
B. Feed Hole Diameter	3.99 ± .20
C. Feed Hole Location	9.02 ± .51
D. Component Lead Spacing	5.00 ^{+0.79} _{-.20} or 2.54 ^{+0.79} _{-.20}
E. Component Lead Location	3.81 ± .51 or 5.00 ± .51 for 2.54 lead spacing
F. Component Lead Protrusion (The lead wire could end in the edge of carrier tape or before of it, inclusive under adhesive tape)	2.00 maximum
K. Component Body Location	6.35 ± .41
L. Carrier Tape Width	18.01 ^{+1.02} _{-.51}
M. Carrier Tape Assembly Thickness	.71 ± .20
N. Carrier Tape Spliced Thickness	1.42 maximum
O. Carrier Tape Spliced Length	50.80 - 88.90
Q. Adhesive Tape Border	3.00 maximum
R. Component Bent Leads (either direction)	.79 maximum .99 maximum
S. Component Misalignment	12.70 ± .99
T. Component Pitch	5.00 minimum
W. Adhesive Tape Width	.51 ± .10
X. Carrier Tape Thickness	254 ± 2.00
Y. Cumulative Pitch over 20 Pitches	

RADIAL LEADS

Packaging

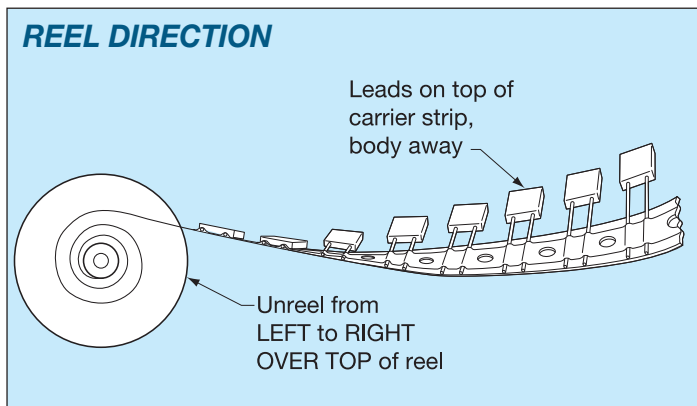

QUANTITY PER REEL SR/AR	
PART	PCS
SR15, 07, 12	3500
SR20, 21, 23, 28 13, 29, 59, 62, 89	3000
SR30, 32, 40, 63, 64 65, 75	2000
MR05, 06	2500

*SL style available in all SR configurations.

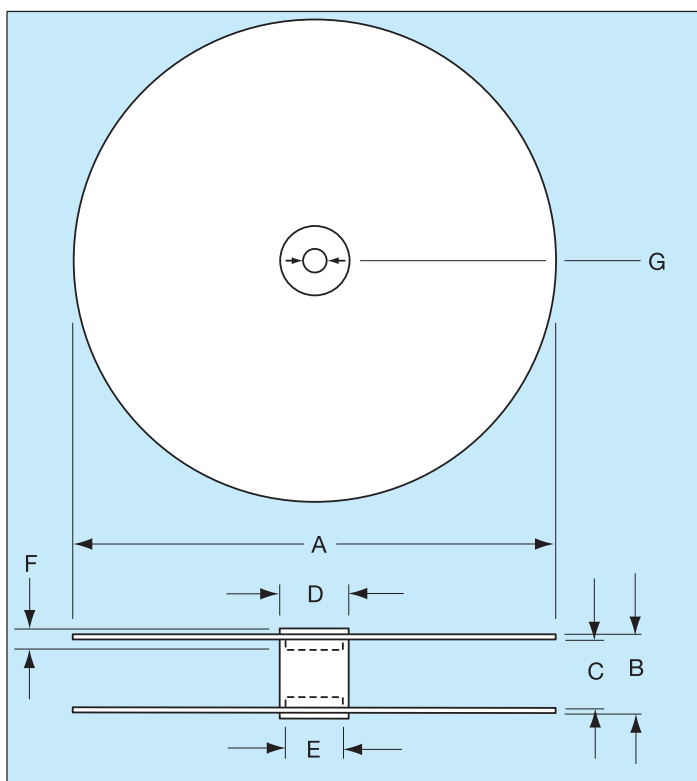

DESCRIPTION	DIMENSIONS (MM)
A - Reel Diameter	304.80 - 355
B - Reel Outside Width	50.80 maximum
C - Reel Inside Width	38.10 - 46.02
D - Core Diameter (O.D.)	102.01 maximum
E - Hub Recess Diameter	86.36 maximum
F - Hub Recess Depth	9.50 minimum
G - Arbor Hole Diameter	25.40 - 30.48

CONVERSION TABLE

MM	IN	MM	IN	MM	IN	MM	IN	MM	IN
.10	.004	1.52	.060	5.00	.197	9.91	.390	32.00	1.260
.20	.007	2.00	.079	5.08	.200	10.03	.395	38.10	1.500
.38	.015	2.54	.100	6.22	.245	10.16	.400	46.02	1.812
.41	.016	3.00	.118	6.35	.250	11.68	.460	50.80	2.000
.51	.020	3.18	.125	6.60	.260	12.50	.492	86.36	3.400
.71	.028	3.48	.137	6.99	.275	12.70	.500	88.90	3.500
.79	.031	3.81	.150	7.62	.300	16.00	.630	102.01	4.016
.99	.039	3.99	.157	8.89	.350	18.01	.709	254.00	10.000
1.02	.040	4.45	.175	9.02	.355	25.40	1.000	304.80	12.000
1.42	.056	4.98	.196	9.50	.374	30.48	1.200	355.00	14.000

TWO PIN DIP

DIPGuard®

GENERAL INFORMATION

MD Series

Temperature Coefficients: COG (NP0), X7R, Z5U, 50, 100 Volts

For established reliability DIPGuards see MIL-PRF-39014 section on pages 60 to 65.

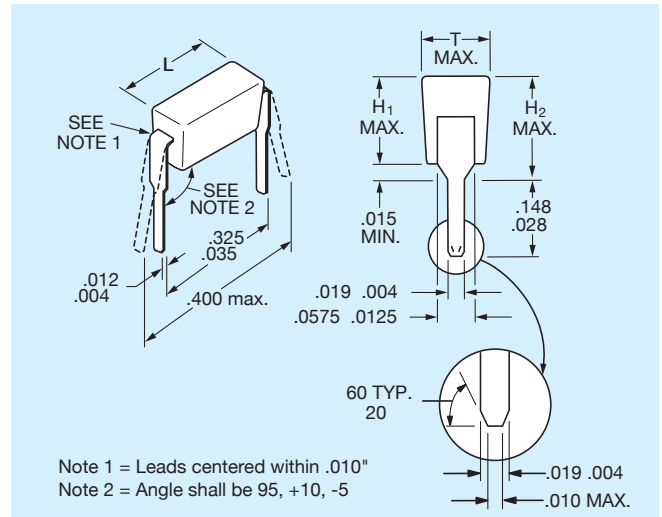

HOW TO ORDER

MD01

Style
MD01
CKR22*
CKS22**
MD02
CKR23*
CKS23*
MD03
CKR24*
CKS24**

5

Voltage
5 = 50V
1 = 100V

E

Temperature Coefficient
A = COG (NP0)
C = X7R
E = Z5U

104

Capacitance
First two digits are the significant figures of capacitance. Third digit indicates the additional number of zeros. For example, order 100,000 pF as 104.

M

Capacitance Tolerance
COG (NP0): F = ±1% J = ±5% K = ±10%
X7R: J = ±5% K = ±10% M = ±20%
Z5U: M = ±20% Z = +80% -20%

A

Failure Rate
A = Not Applicable

B

Assembly Method
A = Hand Assembled
B = Automated Assembly

* Reference pages 58 to 63.

** Reference page 79.

Not RoHS Compliant

MARKING

Part Number Example

MD015 E 104MAB

Top of Unit:

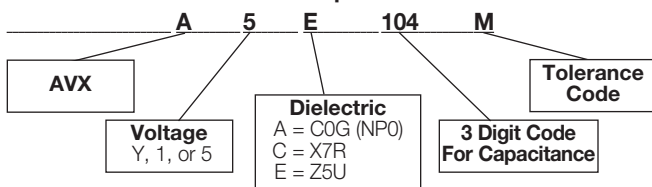

PACKAGING REQUIREMENTS

Standard Packaging: MD01/MD02: 200 pieces per slide pack.
MD03: 200 pieces per vial.

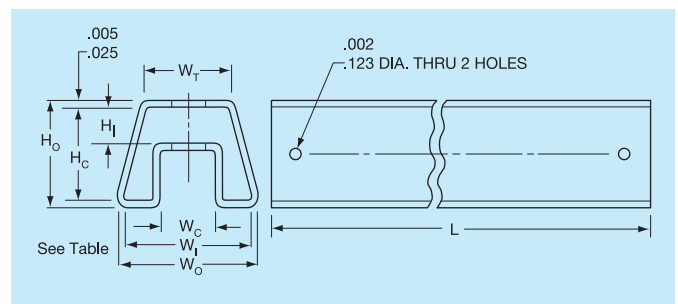

Slide Package Dimensions

	MD01	MD02	MD03*
(HO) Overall Height	.400 ref.	.430 ref.	.545 ref.
(HC) Channel Height	.141 ± .006	.171 ± .006	.295 ± .010
(HI) Inside Height	.350	.380	.495
(WO) Overall Width	.540 ref.	.540 ref.	.600 ref.
(WI) Inside Width	.490	.490	.550
(WC) Channel Width	.210	.210	.170
(WT) Top Width	.350	.310	.300
(L) Length	20.073 ± .06	20.073 ± .06	20.073 ± .06

*Optional

TWO PIN DIP

DIPGuard®



SIZE SPECIFICATIONS

Dimensions: Millimeters (Inches)

Style	Length (L)	Height (H ₁)	Height (H ₂)	Thickness
MD01	6.60 (.260 ± .020)	3.43 (.135 max.)	4.45 (.175 max.)	2.54 (.098 max.)
MD02	6.60 (.260 ± .020)	4.19 (.162 max.)	5.08 (.195 max.)	2.54 (.098 max.)
MD03	6.60 (.260 ± .020)	7.37 (.290 max.)	8.13 (.320 max.)	2.54 (.098 max.)

MILITARY CROSS REFERENCE GUIDE

Note: For CKR22/23/24, see MIL-PRF-39014 section in the Military Section pages 58 thru 63.
For CKS22/23/24 see MIL-PRF-123 section in the Military Section page 79.

Dimensions: Millimeters (Inches)

Style	MIL-PRF-39014	MIL-PRF-123	Length (L)	Height (H ₁)	Height (H ₂)	Thickness
MD01	CKR22	CKS22	6.60 (.260 ± .020)	3.43 (.135 max.)	4.45 (.175 max.)	2.54 (.092 ± .006)
MD02	CKR23	CKS23	6.60 (.260 ± .020)	4.19 (.162 max.)	5.08 (.195 max.)	2.54 (.092 ± .006)
MD03	CKR24	CKS24	6.60 (.260 ± .020)	7.37 (.290 max.)	8.13 (.320 max.)	2.54 (.092 ± .006)

CAPACITANCE SPECIFICATIONS

COG (NP0)

EIA Characteristic		COG (NP0)	
Style		MD01	
Cap. in. pF		WVDC	
		100	50
10	MD015A100KAB		
15	MD015A150KAB		
22	MD015A220KAB		
33	MD015A330KAB		
47	MD015A470KAB		
68	MD015A680KAB		
100	MD015A101KAB		
150	MD015A151KAB		
220	MD015A221KAB		
330	MD015A331KAB		
470	MD015A471KAB		
680	MD015A681KAB		
1000	MD015A102KAB		
1500	MD015A152KAB		
2200	MD015A222KAB		
3300	MD015A332KAB		
Style		MD02	
Cap. in. pF		WVDC	
		100	50
4700	MD025A472KAB		
6800	MD025A682KAB		
10000	MD025A103KAB		

For other voltages and tolerances see Part No. Codes.

X7R

EIA Characteristic		X7R	
Style		MD01	
Cap. in. pF		WVDC	
		100	50
220	MD015C221KAB		
330	MD015C331KAB		
470	MD015C471KAB		
680	MD015C681KAB		
1000	MD015C102KAB		
1500	MD015C152KAB		
2200	MD015C222KAB		
3300	MD015C332KAB		
4700	MD015C472KAB		
6800	MD015C682KAB		
10,000	MD011C103KAB		
15,000	MD015C153KAB		
22,000	MD015C223KAB		
33,000	MD015C333KAB		
47,000	MD015C473KAB		
68,000	MD015C683KAB		
100,000	MD015C104KAB		
Style		MD02	
Cap. in. pF		WVDC	
		100	50
150,000	MD025C154KAB		
220,000	MD025C224KAB		
Style		MD03	
Cap. in. pF		WVDC	
		100	50
330,000	MD035C334KAA		
470,000	MD035C474KAA		
680,000	MD035C684KAA		
1,000,000	MD035C105KAA		
1,500,000	MD035C155KAA		
2,000,000	MD035C205KAA		

For other voltages and tolerances see Part No. Codes.

Z5U

EIA Characteristic		Z5U	
Style		MD01	
Cap. in. pF		WVDC	
		100	50
10,000	MD015E103ZAB		
15,000	MD015E153ZAB		
22,000	MD015E223ZAB		
33,000	MD015E333ZAB		
47,000	MD015E473ZAB		
68,000	MD015E683ZAB		
100,000	MD015E104ZAB		
150,000	MD015E154ZAB		
220,000	MD015E224ZAB		
330,000	MD015E334ZAB		
Style		MD02	
Cap. in. pF		WVDC	
		100	50
470,000	MD025E474ZAB		
Style		MD03	
Cap. in. pF		WVDC	
		100	50
680,000	MD035E684ZAA		
1,000,000	MD035E105ZAA		

For other voltages and tolerances see Part No. Codes.

*Other capacitance values available upon special request.

= Industry preferred values

AXIAL LEADS

SpinGuard®/SA Series

GENERAL INFORMATION

SA Series

Conformally Coated Axial Leaded MLC

Temperature Coefficients: COG (NP0), X7R, X5R, Z5U
10, 50, 100, 200 Volts

Case Material: Epoxy (Flame Retardant to UL Bulletin 492, Par. 280)

Lead Material: Solderable

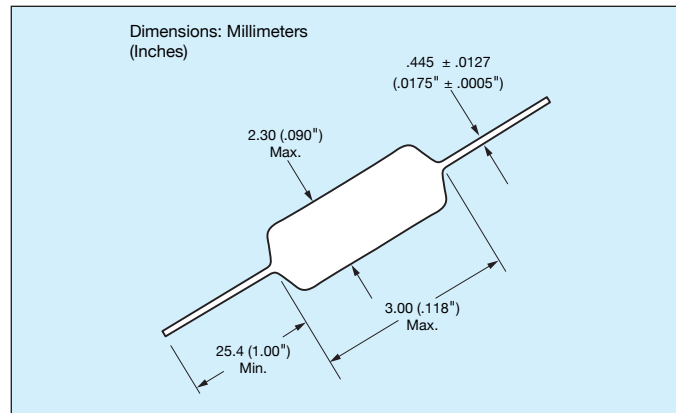

HOW TO ORDER

SA10	5	E	104	Z	A	R
Conformal Axial Size	Voltage	Dielectric	Capacitance	Capacitance Tolerance	Failure Rate	Leads
SA05 SA10 SA11 SA20 SA30 SA40	Z = 10V 5 = 50V 1 = 100V 2 = 200V	A = COG (NP0) C = X7R D = X5R E = Z5U	First two digits are the significant figures of capacitance. Third digit indicates the additional number of zeros. For example, order 100,000 pF as 104. (For values below 10pF use "R" in place of decimal point, e.g., 1R4 = 1.4pF.)	COG (NP0): C = ±.25pF D = ±.5pF F = ±1% G = ±2% J = ±5% K = ±10%	X7R: J = ±5% K = ±10% M = ±20% X5R: K = ±10% M = ±20% Z5U: M = ±20% Z = +80% -20%	A = Not Applicable Standard (Solderable) R = RoHS Compliant A = Standard Solderable (Also RoHS Compliant)

RoHS COMPLIANT

Please select correct termination style.

MARKING (EXAMPLE)

SpinGuard marking includes full date code/lot code identification. A first in the industry, this format provides complete traceability to all manufacturing processes involving the basic chip and final assembly. Total Shipment traceability is also provided.

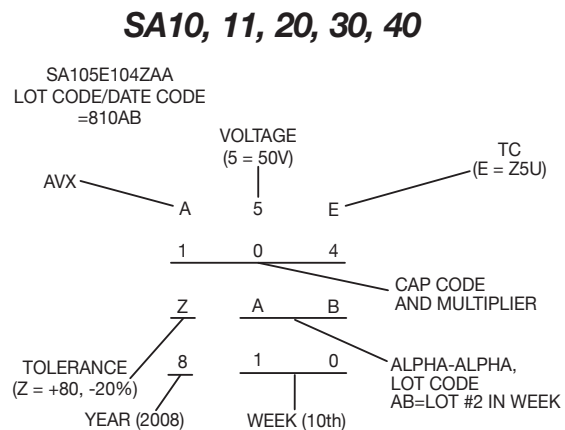
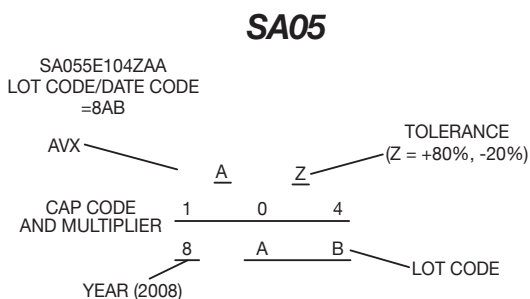

PACKAGING REQUIREMENTS

- A = Standard Reels (see Page 49)
- B = 1000 piece reels (distributors only, tight tolerance only)
- C = Ammo Pack (see Page 49)
- D thru J = See Special Lead Configurations (Page 41)
- M = 26mm tape and reel
- N = 26mm ammo pack
- R = RoHS, Standard reels (See page 49)

AXIAL LEADS

SpinGuard® - SA Series - COG (NP0) Dielectric

SIZE AND CAPACITANCE SPECIFICATIONS

Dimensions: Millimeters (Inches)

Style		SA05		SA10		SA11		SA20		SA30		SA40	
Length (L)		3.00 (.118")		4.32 (.170")		4.32 (.170")		6.60 (.260")		7.37 (.290")		10.16 (.400")	
Diameter (D)		2.30 (.090")		2.54 (.100")		3.05 (.120")		2.54 (.100")		3.81 (.150")		3.81 (.150")	
Lead Diameter		.445 (.0175")		.445 (.0175")		.445 (.0175")		.445 (.0175")		.445 (.0175")		.445 (.0175")	
Lead Length		25.4 (1.00")		25.4 (1.00")		25.4 (1.00")		25.4 (1.00")		25.4 (1.00")		25.4 (1.00")	
Cap. in. pF	Typical Part Nos.	WVDC		WVDC		WVDC		WVDC		WVDC		WVDC	
		100	50	200	100	50	100	50	100	50	100	50	100
1.0*	SA102A1R0DAR												
9.1*	SA102A9R1DAR												
10	SA102A100JAR												
12	SA102A120JAR												
15	SA102A150JAR												
18	SA102A180JAR												
22	SA102A220JAR												
27	SA102A270JAR												
33	SA102A330JAR												
39	SA102A390JAR												
47	SA102A470JAR												
56	SA102A560JAR												
68	SA102A680JAR												
82	SA102A820JAR												
100	SA102A101JAR												
120	SA102A121JAR												
150	SA101A151JAR												
180	SA101A181JAR												
220	SA101A221JAR												
270	SA101A271JAR												
330	SA101A331JAR												
390	SA101A391JAR												
470	SA101A471JAR												
560	SA101A561JAR												
680	SA101A681JAR												
820	SA101A821JAR												
1000	SA105A102JAR												
1200	SA201A122JAR												
1500	SA201A152JAR												
1800	SA205A182JAR												
2200	SA301A222JAR												
2700	SA301A272JAR												
3300	SA301A332JAR												
3900	SA301A392JAR												
4700	SA305A472JAR												
5600	SA401A562JAR												
6800	SA401A682JAR												
8200	SA405A822JAR												
10,000	SA405A103JAR												
12,000	SA405A123JAR												

For other tolerances see Part No. Codes
 For other voltages see Part No. Codes
 KYOCERA AVX Style

= Industry preferred values

**C&D" Tolerance Only

AXIAL LEADS/

SpinGuard® - SA Series - X7R Dielectric

SIZE AND CAPACITANCE SPECIFICATIONS

Dimensions: Millimeters (Inches)



Style	SA05	SA10			SA11		SA20		SA30		SA40	
		Length (L)	Diameter (D)	Lead Diameter	Lead Length	Length (L)	Diameter (D)	Lead Diameter	Lead Length	Length (L)	Diameter (D)	Lead Diameter
220	SA102C221KAR											
270	SA102C271KAR											
330	SA102C331KAR											
390	SA102C391KAR											
470	SA102C471KAR											
560	SA101C561KAR											
680	SA101C681KAR											
820	SA101C821KAR											
1000	SA101C102KAR											
1200	SA101C122KAR											
1500	SA101C152KAR											
1800	SA101C182KAR											
2200	SA101C222KAR											
2700	SA101C272KAR											
3300	SA101C332KAR											
3900	SA101C392KAR											
4700	SA101C472KAR											
5600	SA101C562KAR											
6800	SA101C682KAR											
8200	SA105C822KAR											
10,000	SA105C103KAR											
12,000	SA105C123KAR											
15,000	SA105C153KAR											
18,000	SA105C183KAR											
22,000	SA105C223KAR											
27,000	SA105C273KAR											
33,000	SA105C333KAR											
39,000	SA105C393KAR											
47,000	SA105C473KAR											
56,000	SA115C563KAR											
68,000	SA115C683KAR											
82,000	SA115C823KAR											
100,000	SA115C104KAR											
120,000	SA305C124KAR											
150,000	SA305C154KAR											
180,000	SA305C184KAR											
220,000	SA305C224KAR											
270,000	SA305C274KAR											
330,000	SA305C334KAR											
470,000	SA405C474KAR											
1,000,000	SA305C105KAR											

For other tolerances see Part No. Codes
 For other voltages see Part No. Codes
 Style

= Industry preferred values

AXIAL LEADS/SPINGUARD®

SpinGuard® - SA Series - Z5U Dielectric



SIZE AND CAPACITANCE SPECIFICATIONS

Dimensions: Millimeters (Inches)

Style	SA05	SA10	SA11	SA20	SA30	SA40					
Length (L)	3.00 (.118")	4.32 (.170")	4.32 (.170")	6.60 (.260")	7.37 (.290")	10.16 (.400")					
Diameter (D)	2.30 (.090")	2.54 (.100")	3.05 (.120")	2.54 (.100")	3.81 (.150")	3.81 (.150")					
Lead Diameter	.445 (.0175")	.445 (.0175")	.445 (.0175")	.445 (.0175")	.445 (.0175")	.445 (.0175")					
Lead Length	25.4 (1.00")	25.4 (1.00")	25.4 (1.00")	25.4 (1.00")	25.4 (1.00")	25.4 (1.00")					
Cap. in. pF	Typical Part Nos.	WVDC		WVDC		WVDC		WVDC		WVDC	
		50	100	50	100	50	100	50	100	50	100
10,000	SA105E103ZAR										
15,000	SA105E153ZAR										
22,000	SA105E223ZAR										
33,000	SA105E333ZAR										
47,000	SA105E473ZAR										
68,000	SA105E683ZAR										
*100,000	SA105E104ZAR										
150,000	SA105E154ZAR										
220,000	SA105E224ZAR										
330,000	SA115E334ZAR										
470,000	SA305E474ZAR										
680,000	SA305E684ZAR										
820,000	SA305E824ZAR										
1,000,000	SA305E105ZAR										

For other tolerances see Part No. Codes
 For other voltages see Part No. Codes
 Style

= Industry preferred values

*Preferred Industry Decoupling Capacitor — Insertable on .300" centers.
SA105E104ZAA

AXIAL LEADS

SpinGuard® - SA Series - X7R Dielectric

SIZE AND CAPACITANCE SPECIFICATIONS

Dimensions: Millimeters (Inches)



Style		SA10
Length (L)		4.32 (.170")
Diameter (D)		2.54 (.100")
Lead Diameter		.445 (.0175")
Lead Length		25.4 (1.00")
Cap. in. μ F	Typical Part Nos.	WVDC
1.8	SA10ZD185KAR	10
2.7	SA10ZD275KAR	
3.3	SA10ZD335KAR	
4.7	SA10ZD475KAR	

For other tolerances see Part No. Codes
For other voltages see Part No. Codes
Style

 = Industry preferred values

AXIAL LEADS

SpinGuard® - AA Series - Automotive

GENERAL INFORMATION

AA Series

Electrical Characteristics: AA101C103K4R

Capacitance @ 25°C, 1kHz, 1Vrms	0.0100µF
Capacitance Tolerance	±10 %
Dissipation Factor @ 25°C	2.5% Max
Rated Voltage	100Vdc
Dielectric Withstand Voltage	250Vdc
Insulation Resistance @ 25°C @ Rated Voltage	100000 Mohms

Temperature Characteristics:

X7R (-55 to + 125°C ± 15% @ 0Vdc)

Lead Material:

RoHS Compliant 100% Tin

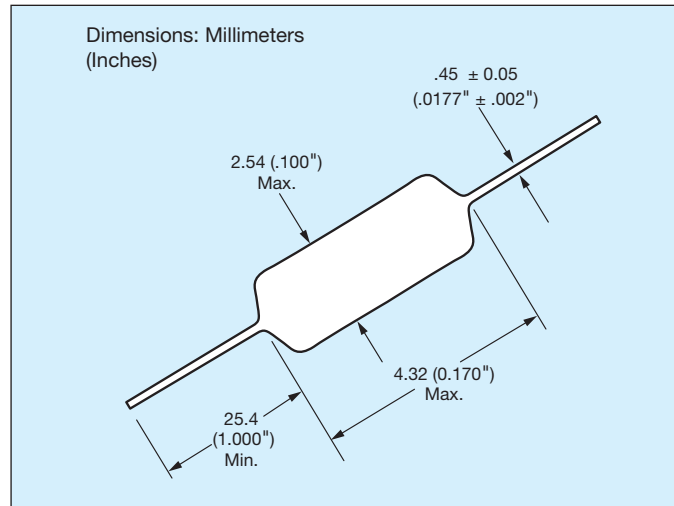

HOW TO ORDER

AA10	1	C	103	K	4	R	
Component Size	Voltage Rating	Dielectric	Capacitance Code	Capacitance Tolerance Code	Failure Rate	RoHS Compliant	
AA10 AA13	Z = 10V 5 = 50V 1 = 100V 2 = 200V	A = COG (NP0) C = X7R	First two digits are the significant figures of capacitance. Third digit indicates the additional number of zeros. For example, order 100,000 pF as 104. (For values below 10pF use "R" in place of decimal point, e.g., 1R4 = 1.4pF.)	COG (NP0): C = ± .25pF D = ± .5pF F = ±1% G = ±2% J = ±5% K = ±10%	X7R: J = ±5% K = ±10% M = ±20%	R = RoHS Compliant	
					4 = Automotive		

MARKING (EXAMPLE)

SpinGuard marking includes full date code/lot code identification. A first in the industry, this format provides complete traceability to all manufacturing processes involving the basic chip and final assembly. Total Shipment traceability is also provided.

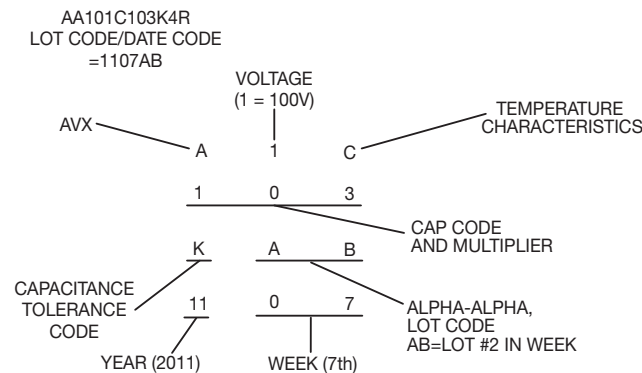

PACKAGING REQUIREMENTS

Tape and Reel Ø 14": 7500 pieces

AXIAL LEADS

SpinGuard® – AA Series – Automotive – COG (NP0) Dielectric



SIZE AND CAPACITANCE SPECIFICATIONS

Dimensions: Millimeters (Inches)



Style		AA10			AA30	
Length (L)		4.32 (.170")			7.37 (.290")	
Diameter (D)		2.54 (.100")			3.81 (.150")	
Lead Diameter		.445 (.0175")			.445 (.0175")	
Lead Length		25.4 (1.00")			25.4 (1.00")	
Cap. in. pF	Typical Part Nos.	WVDC			WVDC	
		200	100	50	100	50
100	AA.....A101K4R					
120	AA.....A121K4R					
150	AA.....A151K4R					
180	AA.....A181K4R					
220	AA.....A221K4R					
270	AA.....A271K4R					
330	AA.....A331K4R					
390	AA.....A391K4R					
470	AA.....A471K4R					
560	AA.....A561K4R					
680	AA.....A681K4R					
820	AA.....A821K4R					
1,000	AA.....A102K4R					
1,200	AA.....A122K4R					
1,500	AA.....A152K4R					
1,800	AA.....A182K4R					
2,200	AA.....A222K4R					
2,700	AA.....A272K4R					
3,300	AA.....A332K4R					
3,900	AA.....A392K4R					
4,700	AA.....A472K4R					
5,600	AA.....A562K4R					
6,800	AA.....A682K4R					
8,200	AA.....A822K4R					
10,000	AA.....A103K4R					

For other voltage and tolerances contact factory.

*Other capacitance values available upon special request.

AXIAL LEADS

SpinGuard® – AA Series – Automotive – X7R Dielectric



SIZE AND CAPACITANCE SPECIFICATIONS

Dimensions: Millimeters (Inches)

Style		AA10		AA30	
		Length (L)		Diameter (D)	
		4.32 (.170")		7.37 (.290")	
		2.54 (.100")		3.81 (.150")	
		.445 (.0175")		.445 (.0175")	
		25.4 (1.00")		25.4 (1.00")	
Cap. in. pF	Typical Part Nos.	WVDC		WVDC	
		100	50	100	50
220	AA__C221K4R				
270	AA__C271K4R				
330	AA__C331K4R				
390	AA__C391K4R				
470	AA__C471K4R				
560	AA__C561K4R				
680	AA__C681K4R				
820	AA__C821K4R				
1,000	AA__C102K4R				
1,200	AA__C122K4R				
1,500	AA__C152K4R				
1,800	AA__C182K4R				
2,200	AA__C222K4R				
2,700	AA__C272K4R				
3,300	AA__C332K4R				
3,900	AA__C392K4R				
4,700	AA__C472K4R				
5,600	AA__C562K4R				
6,800	AA__C682K4R				
8,200	AA__C822K4R				
10,000	AA__C103K4R				
12,000	AA__C123K4R				
15,000	AA__C153K4R				
18,000	AA__C183K4R				
22,000	AA__C223K4R				
27,000	AA__C273K4R				
33,000	AA__C333K4R				
39,000	AA__C393K4R				
47,000	AA__C473K4R				
56,000	AA__C563K4R				
68,000	AA__C683K4R				
82,000	AA__C823K4R				
100,000	AA__C104K4R				

For other voltage and tolerances contact factory.

*Other capacitance values available upon special request.

AXIAL LEADS

Ceramam®

GENERAL INFORMATION

SA Series

Molded Axial Leaded MLC

Temperature Coefficients: COG (NP0), X7R, Z5U

50V, 100V and 200V

Case Material: Molded Epoxy

Lead Material: Solderable

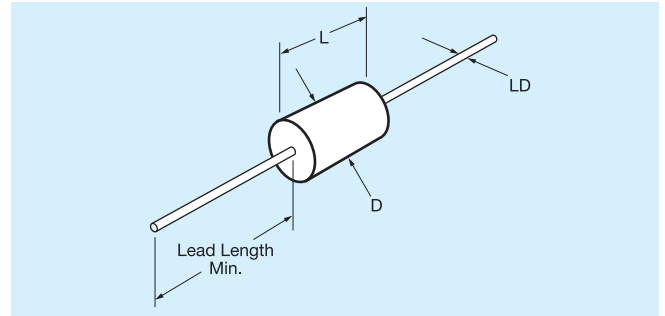

HOW TO ORDER

MA10	5	E	104	Z	A	R
Molded Axial Size	Voltage	Dielectric	Capacitance	Capacitance Tolerance	Failure Rate	Leads
MA10 MA20 MA30 MA40 MA50 MA60	5 = 50V 1 = 100V 2 = 200V	A = COG (NP0) C = X7R E = Z5U	First two digits are the significant figures of capacitance. Third digit indicates the additional number of zeros. For example, order 100,000 pF as 104. (For values below 10pF use "R" in place of decimal point, e.g., 1R4 = 1.4pF)	COG (NP0): F = ±1% J = ±5% K = ±10% M = ±20% D = ±0.5pF <10pF only	X7R: J = ±5% K = ±10% M = ±20%	Z5U: M = ±20% Z = +80% -20%
					A = Not Applicable	A = Standard

Not RoHS Compliant

‡ C tolerance available COG (NP0) from 1.0 to 9.1 pF only. Minimum tolerance for values 10 pF - 100 pF is D or F whichever is greater.

MARKING (EXAMPLE)

Line 1, A (for KYOCERA AVX), 5 = 50 Volts (V is optional),
E = TC Line 2, 104Z = Capacitance Code

Line 3, Tolerance, 2 digit Lot Code

Date Code: 8 = 2008
10 = Week

Four Digit Date Code Optional

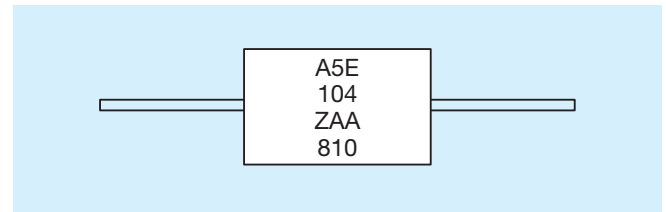

MILITARY CROSS REFERENCE AND DIMENSIONS GUIDE

Style	Per MIL-Spec			Case Size		
	MIL-C-11015	MIL-PRF-39014	MIL-PRF-20	Length (L)	Diameter (D)	Lead Diameter (LD)
MA10	CK12	CKR11	CCR75/CC75	4.07 ± .25 (.160" ± .010")	2.29 ± .25 (.090" ± .010")	.48 ± .05 (.019" ± .002")
MA20	CK13	CKR12	CCR76/CC76	6.35 ± .25 (.250" ± .010")	2.29 ± .25 (.090" ± .010")	.48 ± .05 (.019" ± .002")
MA40	CK14	CKR14	CCR77/CC77	9.91 ± .25 (.390" ± .010")	3.56 ± .25 (.140" ± .010")	.63 ± .05 (.025" ± .002")
MA50	CK15	CKR15	CCR78/CC78	12.7 ± .51 (.500" ± .020")	6.35 ± .38 (.250" ± .015")	.63 ± .05 (.025" ± .002")
MA60	CK16	CKR16	CCR79/CC79	17.53 ± .51 (.690" ± .020")	8.89 ± .51 (.350" ± .015")	.63 ± .05 (.025" ± .002")

For Military/Established Reliability Molded/Axial Lead see MIL-C-11015, MIL-PRF-39014, MIL-PRF-20 Section.

Dimensions: Millimeters (Inches)

AXIAL LEADS

Cerlam® – COG (NP0) Dielectric

SIZE AND CAPACITANCE SPECIFICATIONS

Dimensions: Millimeters (Inches)



Style	MA10			MA20			MA30			MA40			MA50			MA60			
	Length	Diameter	Lead Diameter	Length	Diameter	Lead Diameter	Length	Diameter	Lead Diameter	Length	Diameter	Lead Diameter	Length	Diameter	Lead Diameter	Length	Diameter	Lead Diameter	
1.0 to 9.1	4.07 ± .25 (.160" ± .010")	2.29 ± .25 (.090" ± .010")	.48 ± .05 (.019" ± .002")	6.35 ± .25 (.250" ± .010")	2.29 ± .25 (.090" ± .010")	.48 ± .05 (.019" ± .002")	6.09 ± .25 (.240" ± .010")	3.30 ± .25 (.130" ± .010")	.48 ± .05 (.019" ± .002")	9.91 ± .25 (.390" ± .010")	3.56 ± .25 (.140" ± .010")	.63 ± .05 (.025" ± .002")	12.7 ± .51 (.500" ± .020")	6.35 ± .38 (.250" ± .015")	.63 ± .05 (.025" ± .002")	17.53 ± .51 (.690" ± .020")	8.89 ± .51 (.350" ± .015")	.63 ± .05 (.025" ± .002")	
Cap. in. pF	VVDC			VVDC			VVDC			VVDC			VVDC			VVDC			
Typical Part Nos.	200	100	50	200	100	50	200	100	50	200	100	50	200	100	50	200	100	50	
10 MA...5A1R0DAA																			
10 MA...5A100KAA																			
12 MA...5A120KAA																			
15 MA...5A150KAA																			
18 MA...5A180KAA																			
22 MA...5A220KAA																			
27 MA...5A270KAA																			
33 MA...5A330KAA																			
39 MA...5A390KAA																			
47 MA...5A470KAA																			
56 MA...5A560KAA																			
68 MA...5A680KAA																			
82 MA...5A820KAA																			
100 MA...5A101KAA																			
120 MA...5A121KAA																			
150 MA...5A151KAA																			
180 MA...5A181KAA																			
220 MA...5A221KAA																			
270 MA...5A271KAA																			
330 MA...5A331KAA																			
390 MA...5A391KAA																			
470 MA...5A471KAA																			
560 MA...5A561KAA																			
680 MA...5A681KAA																			
820 MA...5A821KAA																			
1000 MA...5A102KAA																			
1200 MA...5A122KAA																			
1500 MA...5A152KAA																			
1800 MA...5A182KAA																			
2200 MA...5A222KAA																			
2700 MA...5A272KAA																			
3300 MA...5A332KAA																			
3900 MA...5A392KAA																			
4700 MA...5A472KAA																			
5600 MA...5A562KAA																			
6800 MA...5A682KAA																			
8200 MA...5A822KAA																			
10,000 MA...5A103KAA																			
12,000 MA...5A123KAA																			
15,000 MA...5A153KAA																			
18,000 MA...5A183KAA																			
22,000 MA...5A223KAA																			
27,000 MA...5A273KAA																			
33,000 MA...5A333KAA																			
39,000 MA...5A393KAA																			
47,000 MA...5A473KAA																			
56,000 MA...5A563KAA																			
68,000 MA...5A683KAA																			
82,000 MA...5A823KAA																			
100,000 MA...5A104KAA																			
120,000 MA...5A124KAA																			
150,000 MA...5A154KAA																			

For other tolerances see Part No. Codes
 For other voltages see Part No. Codes
 Style

AXIAL LEADS

Cerlam® - X7R Dielectric

SIZE AND CAPACITANCE SPECIFICATIONS



Dimensions: Millimeters (Inches)

Style	MA10			MA20			MA30			MA40			MA50			MA60						
	Length	Diameter	Lead Diameter	Length	Diameter	Lead Diameter	Length	Diameter	Lead Diameter	Length	Diameter	Lead Diameter	Length	Diameter	Lead Diameter	Length	Diameter	Lead Diameter				
	4.07 ± .25 (.160" ± .010")	2.29 ± .25 (.090" ± .010")	.48 ± .05 (.019" ± .002")	6.35 ± .25 (.250" ± .010")	2.29 ± .25 (.090" ± .010")	.48 ± .05 (.019" ± .002")	6.09 ± .25 (.240" ± .010")	3.30 ± .25 (.130" ± .010")	.48 ± .05 (.019" ± .002")	9.91 ± .25 (.390" ± .010")	3.56 ± .25 (.140" ± .010")	.63 ± .05 (.025" ± .002")	12.7 ± .51 (.500" ± .020")	6.35 ± .38 (.250" ± .015")	.63 ± .05 (.025" ± .002")	17.53 ± .51 (.690" ± .020")	8.89 ± .51 (.350" ± .015")	.63 ± .05 (.025" ± .002")				
	25.4 (1.00")	25.4 (1.00")	25.4 (1.00")	25.4 (1.00")	25.4 (1.00")	25.4 (1.00")	25.4 (1.00")	25.4 (1.00")	25.4 (1.00")	25.4 (1.00")	25.4 (1.00")	25.4 (1.00")	25.4 (1.00")	25.4 (1.00")	25.4 (1.00")	25.4 (1.00")	25.4 (1.00")	25.4 (1.00")	25.4 (1.00")			
Cap. in. pF	WVDC			WVDC			WVDC			WVDC			WVDC			WVDC						
Typical Part Nos.	200	100	50	200	100	50	200	100	50	200	100	50	200	100	50	200	100	50	200	100	50	
220	MA.....5C221KAA																					
270	MA.....5C271KAA																					
330	MA.....5C331KAA																					
390	MA.....5C391KAA																					
470	MA.....5C471KAA																					
560	MA.....5C561KAA																					
680	MA.....5C681KAA																					
820	MA.....5C821KAA																					
1000	MA.....5C102KAA																					
1200	MA.....5C122KAA																					
1500	MA.....5C152KAA																					
1800	MA.....5C182KAA																					
2200	MA.....5C222KAA																					
2700	MA.....5C272KAA																					
3300	MA.....5C332KAA																					
3900	MA.....5C392KAA																					
4700	MA.....5C472KAA																					
5600	MA.....5C562KAA																					
6800	MA.....5C682KAA																					
8200	MA.....5C822KAA																					
10,000	MA.....5C103KAA																					
12,000	MA.....5C123KAA																					
15,000	MA.....5C153KAA																					
18,000	MA.....5C183KAA																					
22,000	MA.....5C223KAA																					
27,000	MA.....5C273KAA																					
33,000	MA.....5C333KAA																					
39,000	MA.....5C393KAA																					
47,000	MA.....5C473KAA																					
56,000	MA.....5C563KAA																					
68,000	MA.....5C683KAA																					
82,000	MA.....5C823KAA																					
100,000	MA.....5C104KAA																					
120,000	MA.....5C124KAA																					
150,000	MA.....5C154KAA																					
180,000	MA.....5C184KAA																					
220,000	MA.....5C224KAA																					
270,000	MA.....5C274KAA																					
330,000	MA.....5C334KAA																					
390,000	MA.....5C394KAA																					
470,000	MA.....5C474KAA																					
560,000	MA.....5C564KAA																					
680,000	MA.....5C684KAA																					
820,000	MA.....5C824KAA																					
1.0 µF	MA.....5C105KAA																					
1.2 µF	MA.....5C125KAA																					
1.5 µF	MA.....5C155KAA																					
1.8 µF	MA.....5C185KAA																					
2.2 µF	MA.....5C225KAA																					
2.7 µF	MA.....5C275KAA																					
3.3 µF	MA.....5C335KAA																					
3.9 µF	MA.....5C395KAA																					

For other tolerances see Part No. Codes
 For other voltages see Part No. Codes
 Style

AXIAL LEADS

Ceramam® - Z5U Dielectric

SIZE AND CAPACITANCE SPECIFICATIONS

Dimensions: Millimeters (Inches)



Style	MA10	MA20			MA30			MA40			MA50			MA60			
		Length	Diameter		Lead Diameter	Lead Length	Cap. in. pF	Typical Part Nos.	WVDC		WVDC		WVDC		WVDC		
	4.07 ± .25 (.160" ± .010")	6.35 ± .25 (.250" ± .010")	6.35 ± .25 (.250" ± .010")	6.09 ± .25 (.240" ± .010")	9.91 ± .25 (.390" ± .010")	12.7 ± .51 (.500" ± .020")	17.53 ± .51 (.690" ± .020")		200	100	50	200	100	50	200	100	50
1000	MA.....5E102ZAA																
1200	MA.....5E122ZAA																
1500	MA.....5E152ZAA																
1800	MA.....5E182ZAA																
2200	MA.....5E222ZAA																
2700	MA.....5E272ZAA																
3300	MA.....5E332ZAA																
3900	MA.....5E392ZAA																
4700	MA.....5E472ZAA																
5600	MA.....5E562ZAA																
6800	MA.....5E682ZAA																
8200	MA.....5E822ZAA																
10,000	MA.....5E103ZAA																
12,000	MA.....5E123ZAA																
15,000	MA.....5E153ZAA																
18,000	MA.....5E183ZAA																
22,000	MA.....5E223ZAA																
27,000	MA.....5E273ZAA																
33,000	MA.....5E333ZAA																
39,000	MA.....5E393ZAA																
47,000	MA.....5E473ZAA																
56,000	MA.....5E563ZAA																
68,000	MA.....5E683ZAA																
82,000	MA.....5E823ZAA																
100,000	MA.....5E104ZAA																
120,000	MA.....5E124ZAA																
150,000	MA.....5E154ZAA																
180,000	MA.....5E184ZAA																
220,000	MA.....5E224ZAA																
270,000	MA.....5E274ZAA																
330,000	MA.....5E334ZAA																
390,000	MA.....5E394ZAA																
470,000	MA.....5E474ZAA																
560,000	MA.....5E564ZAA																
680,000	MA.....5E684ZAA																
820,000	MA.....5E824ZAA																
1.0 µF	MA.....5E105ZAA																
1.2 µF	MA.....5E125ZAA																
1.5 µF	MA.....5E155ZAA																
1.8 µF	MA.....5E185ZAA																
2.2 µF	MA.....5E225ZAA																
2.7 µF	MA.....5E275ZAA																
3.3 µF	MA.....5E335ZAA																
3.9 µF	MA.....5E395ZAA																
4.7 µF	MA.....5E475ZAA																
5.6 µF	MA.....5E565ZAA																
6.8 µF	MA.....5E685ZAA																
8.2 µF	MA.....5E825ZAA																

For other tolerances see Part No. Codes
 For other voltages see Part No. Codes
 Style

AXIAL LEADS

Packaging

TAPE AND REEL

CLASS I / RS-296	
A.	5mm ± 0.5mm (.200" ± 0.020")
B*.	52.4mm ± 1.5mm (2.063" ± 0.059")
C.	6.35mm ± 0.4mm (0.250" ± 0.016")
D1-D2.	1.4mm (0.055" MAX.)
E.	1.2mm (0.047" MAX.)
F.	1.6mm (0.063" MAX.)
G.	356mm (14.00")
H.	76mm (3.000")
I.	25.4mm (1.000")
J.	84mm (3.300")
K.	70mm (2.750")

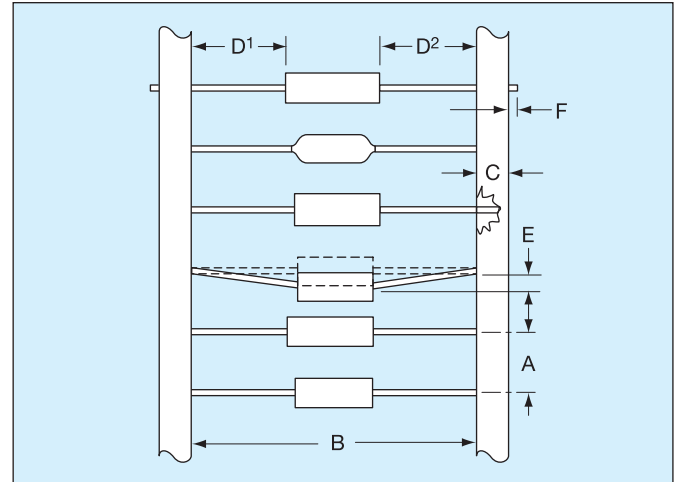

Leader Tape: 300mm min. (12")

Splicing: Tape Only

Missing Parts: 0.25% of component count max.-
No consecutive missing parts

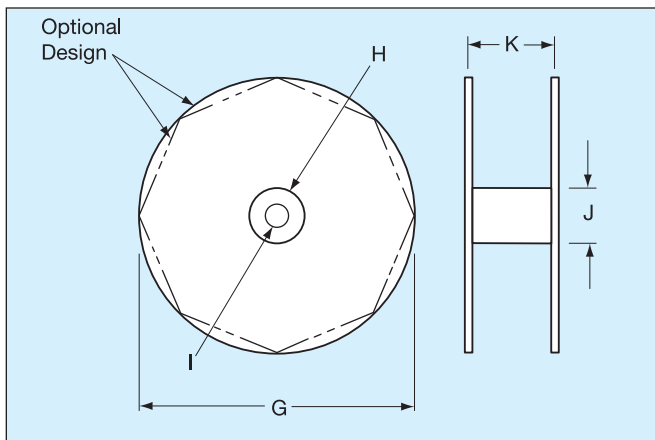

REEL QUANTITIES (MAX.) ‡

SA05	7,500 pcs.	MA10	5,000 pcs.
SA10	7,500 pcs.	MA20	5,000 pcs.
SA11	5,000 pcs.	MA30	3,000 pcs.
SA20	5,000 pcs.	MA40	3,000 pcs.
SA30	5,000 pcs.	MA50	950 pcs.
SA40	5,000 pcs.	MA60	650 pcs.

‡ 1000 pc. reels available for distribution pack only in ±1% and ±2% tolerance.

* Standard Tape Spacing Shown. Also available in 26.0mm + 1.5mm, -0mm, (1.023 in. + .059 in. -0 in.) for SpinGuards only. EIA Class I, II and III tape spacings are available for molded axials. Tape spacing for Class II is 63.5mm ± 1.5mm (2.50 in ± .059 in), and for Class III 73mm ± 1.5mm (2.87 in ± .059 in)

ADDITIONAL PACKAGING AVAILABLE

AMMO PACK

Tape Spacing	SA05, SA10 SA20	SA11 SA30	SA40	BOX SIZES (Nominal)		
				L	W	H
52.4mm ± 1.5mm (2.062" ± .059")	4,000 pcs.	2000	2,000 pcs.	255mm (10.039")	73mm (2.874")	93mm (3.661")
26.0mm + 1.5mm - 0mm (1.023" + .059" - 0")	4,000 pcs.*	2000	2,000 pcs.*	255mm (10.039")	48mm (1.889")	113mm (4.448")

*SpinGuard only

BULK PACK (MOLDED AXIALS ONLY)

MA10 MA20 MA30 MA40	100 pcs. (bag)
MA50 MA60	50 pcs. (bag)

Radial Leads

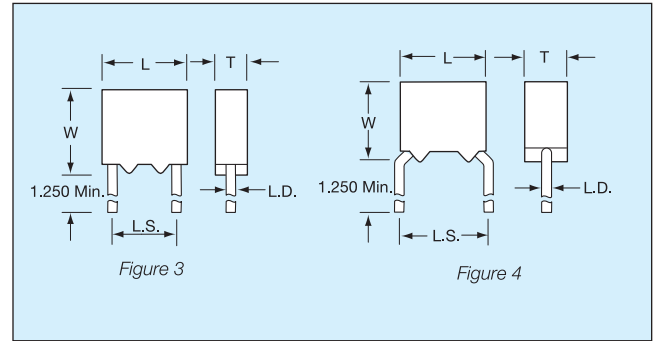
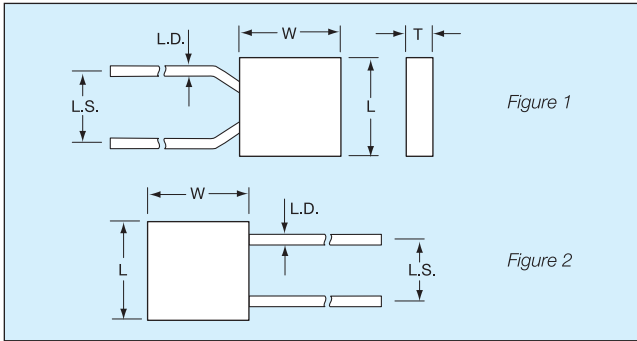

HOW TO ORDER

Military Type Designation: Styles CKR04, CKR05, CKR06, CKR08

Dash Number Option: MIL-PRF-39014/01 (Appropriate Dash Number)

CKR05

Style

CK = General purpose, ceramic dielectric, fixed capacitors
R = Established Reliability Parts
05 = Remaining two numbers identify shape and dimension

BX

Voltage-Temperature Limits

First letter identifies temperature range.
B = -55°C to +125°C
Second letter identifies voltage-temperature coefficient.

Capacitance Change with Reference to 25°C		
Second Letter	No Voltage	Rated Voltage
X	+15, -15%	+15, -25%

104

Capacitance

First two digits are the significant figures of capacitance. Third digit indicates the additional number of zeros. For example, order 100,000 pF as 104. (For values below 10pF use "R" in place of decimal point, e.g., 1R4 = 1.4pF.)

K

Capacitance Tolerance

K = ±10%
M = ±20%

S

Military Failure Rate

M = 1% per 1000 hours
P = 0.1% per 1000 hours
R = 0.01% per 1000 hours
S = 0.001% per 1000 hours

Note:
KYOCERA AVX reserves the right to CKR05BX104KSV substitute a lower failure rate part per MIL-PRF-39014. Substitutability for failure rate levels shall be as follows:

Failure Rate Level	Will Replace Failure Rate Level
S (STD) (X-ray)	R, P, M, L
R (STD) (No X-ray)	P, M, L
P	M, L
M	L

(V)

Standoff Option

To order standoff option, place "V" at the end of the part number.
Example:

Not RoHS Compliant

PACKAGING REQUIREMENTS

Packaging: 100 Pcs/bag; Radial Tape and Reel Packaging available upon request (2500 pcs./reel).

SIZE SPECIFICATIONS millimeters (Inches)

Per Mil Spec	Case Size				
	Length (L)	Width (W)	Thickness (T)	Lead Spacing (L.S.)	Lead Diameter (L.D.)
MIL-PRF-39014					
CKR04 (Fig. 2)	4.83±.25 (.190±.010)	4.83±.25 (.190±.010)	2.29±.25 (.090±.010)	2.54±.38 (.100±.015)	.64±.05 (.025±.002)
CKR05 (Fig. 1, 4)	4.83±.25 (.190±.010)	4.83±.25 (.190±.010)	2.29±.25 (.090±.010)	5.08±.38 (.200±.015)	.64±.05 (.025±.002)
CKR06 (Fig. 2, 3)	7.37±.25 (.290±.010)	7.37±.25 (.290±.010)	2.29±.25 (.090±.010)	5.08±.38 (.200±.015)	.64±.05 (.025±.002)
CKR08 (Fig. 2)	7.37±.25 (.290±.010)	7.37±.25 (.290±.010)	3.68±.38 (.145±.015)	5.08±.38 (.200±.015)	.64±.05 (.025±.002)

Only CKR05 and CKR06 can be offered on T&R

MARKING RADIAL LEAD

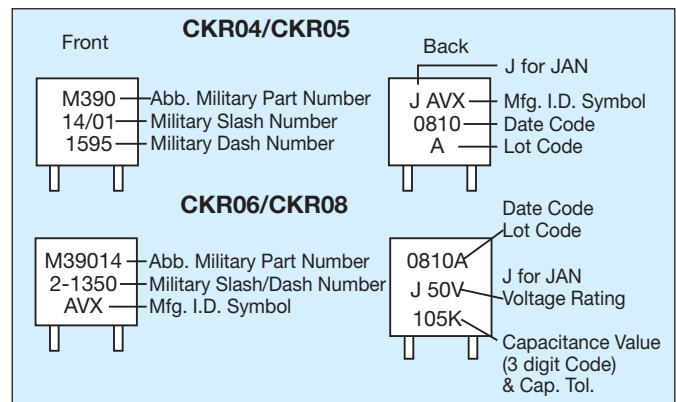

MILITARY DASH NUMBER IDENTIFICATION CKR04 TO MIL-PRF-39014/23

(Dash Number From Table)

Military Type Designation	Failure Rate Level (%/1,000 Hours)				Capacitance (pF)	Capacitance Tolerance ±Percent	WVDC
	1.0 (M)	0.1 (P)	0.01 (R)	0.001 (S)			
CKR04 (BX)							
CKR04BX100K_	0001	0101	0201	0301	10	10	200
CKR04BX100M_	0002	0102	0202	0302	10	20	200
CKR04BX120K_	0003	0103	0203	0303	12	10	200
CKR04BX150K_	0004	0104	0204	0304	15	10	200
CKR04BX150M_	0005	0105	0205	0305	15	20	200
CKR04BX180K_	0006	0106	0206	0306	18	10	200
CKR04BX220K_	0007	0107	0207	0307	22	10	200
CKR04BX220M_	0008	0108	0208	0308	22	20	200
CKR04BX270K_	0009	0109	0209	0309	27	10	200
CKR04BX330K_	0010	0110	0210	0310	33	10	200
CKR04BX330M_	0011	0111	0211	0311	33	20	200
CKR04BX390K_	0012	0112	0212	0312	39	10	200
CKR04BX470K_	0013	0113	0213	0313	47	10	200
CKR04BX470M_	0014	0114	0214	0314	47	20	200
CKR04BX560K_	0015	0115	0215	0315	56	10	200
CKR04BX680K_	0016	0116	0216	0316	68	10	200
CKR04BX680M_	0017	0117	0217	0317	68	20	200
CKR04BX820K_	0018	0118	0218	0318	82	10	200
CKR04BX101K_	0019	0119	0219	0319	100	10	200
CKR04BX101M_	0020	0120	0220	0320	100	20	200
CKR04BX121K_	0021	0121	0221	0321	120	10	200
CKR04BX151K_	0022	0122	0222	0322	150	10	200
CKR04BX151M_	0023	0123	0223	0323	150	20	200
CKR04BX181K_	0024	0124	0224	0324	180	10	200
CKR04BX221K_	0025	0125	0225	0325	220	10	200
CKR04BX221M_	0026	0126	0226	0326	220	20	200
CKR04BX271K_	0027	0127	0227	0327	270	10	200
CKR04BX331K_	0028	0128	0228	0328	330	10	200
CKR04BX331M_	0029	0129	0229	0329	330	20	200
CKR04BX391K_	0030	0130	0230	0330	390	10	200
CKR04BX471K_	0031	0131	0231	0331	470	10	200
CKR04BX471M_	0032	0132	0232	0332	470	20	200
CKR04BX561K_	0033	0133	0233	0333	560	10	200
CKR04BX681K_	0034	0134	0234	0334	680	10	200
CKR04BX681M_	0035	0135	0235	0335	680	20	200
CKR04BX821K_	0036	0136	0236	0336	820	10	200
CKR04BX102K_	0037	0137	0237	0337	1,000	10	200
CKR04BX102M_	0038	0138	0238	0338	1,000	20	200
CKR04BX122K_	0039	0139	0239	0339	1,200	10	100
CKR04BX152K_	0040	0140	0240	0340	1,500	10	100
CKR04BX152M_	0041	0141	0241	0341	1,500	20	100
CKR04BX182K_	0042	0142	0242	0342	1,800	10	100
CKR04BX222K_	0043	0143	0243	0343	2,200	10	100
CKR04BX222M_	0044	0144	0244	0344	2,200	20	100
CKR04BX272K_	0045	0145	0245	0345	2,700	10	100
CKR04BX332K_	0046	0146	0246	0346	3,300	10	100
CKR04BX332M_	0047	0147	0247	0347	3,300	20	100
CKR04BX392K_	0048	0148	0248	0348	3,900	10	100
CKR04BX472K_	0049	0149	0249	0349	4,700	10	100
CKR04BX472M_	0050	0150	0250	0350	4,700	20	100
CKR04BX562K_	0051	0151	0251	0351	5,600	10	100
CKR04BX682K_	0052	0152	0252	0352	6,800	10	100
CKR04BX682M_	0053	0153	0253	0353	6,800	20	100
CKR04BX822K_	0054	0154	0254	0354	8,200	10	100
CKR04BX103K_	0055	0155	0255	0355	10,000	10	100
CKR04BX103M_	0056	0156	0256	0356	10,000	20	100
CKR04BX123K_	0057	0157	0257	0357	12,000	10	50
CKR04BX153K_	0058	0158	0258	0358	15,000	10	50
CKR04BX153M_	0059	0159	0259	0359	15,000	20	50
CKR04BX183K_	0060	0160	0260	0360	18,000	10	50
CKR04BX223K_	0061	0161	0261	0361	22,000	10	50
CKR04BX223M_	0062	0162	0262	0362	22,000	20	50
CKR04BX273K_	0063	0163	0263	0363	27,000	10	50
CKR04BX333K_	0064	0164	0264	0364	33,000	10	50
CKR04BX333M_	0065	0165	0265	0365	33,000	20	50
CKR04BX393K_	0066	0166	0266	0366	39,000	10	50
CKR04BX473K_	0067	0167	0267	0367	47,000	10	50
CKR04BX473M_	0068	0168	0268	0368	47,000	20	50
CKR04BX563K_	0069	0169	0269	0369	56,000	10	50
CKR04BX683K_	0070	0170	0270	0370	68,000	10	50
CKR04BX683M_	0071	0171	0271	0371	68,000	20	50
CKR04BX823K_	0072	0172	0272	0372	82,000	10	50
CKR04BX104K_	0073	0173	0273	0373	100,000	10	50
CKR04BX104M_	0074	0174	0274	0374	100,000	20	50

Add appropriate failure rate level letter (M, P, R or S)

MILITARY DASH NUMBER IDENTIFICATION CKR05 TO MIL-PRF-39014/01

(Dash Number From Table)

Military Type Designation	Failure Rate Level (%/1,000 Hours)				Capacitance (pF)	Capacitance Tolerance ±Percent	WVDC
	1.0 (M)	0.1 (P)	0.01 (R)	0.001 (S)			
CKR05 (BX)							
CKR05BX100K_	1201	1241	1281	1321	10	10	200
CKR05BX100M_	1202	1242	1282	1322	10	20	200
CKR05BX120K_	1203	1243	1283	1323	12	10	200
CKR05BX150K_	1204	1244	1284	1324	15	10	200
CKR05BX150M_	1205	1245	1285	1325	15	20	200
CKR05BX180K_	1206	1246	1286	1326	18	10	200
CKR05BX220K_	1207	1247	1287	1327	22	10	200
CKR05BX220M_	1208	1248	1288	1328	22	20	200
CKR05BX270K_	1209	1249	1289	1329	27	10	200
CKR05BX330K_	1210	1250	1290	1330	33	10	200
CKR05BX330M_	1211	1251	1291	1331	33	20	200
CKR05BX390K_	1212	1252	1292	1332	39	10	200
CKR05BX470K_	1213	1253	1293	1333	47	10	200
CKR05BX470M_	1214	1254	1294	1334	47	20	200
CKR05BX560K_	1215	1255	1295	1335	56	10	200
CKR05BX680K_	1216	1256	1296	1336	68	10	200
CKR05BX680M_	1217	1257	1297	1337	68	20	200
CKR05BX820K_	1218	1258	1298	1338	82	10	200
CKR05BX101K_	1219	1259	1299	1339	100	10	200
CKR05BX101M_	1220	1260	1300	1340	100	20	200
CKR05BX121K_	1221	1261	1301	1341	120	10	200
CKR05BX151K_	1222	1262	1302	1342	150	10	200
CKR05BX151M_	1223	1263	1303	1343	150	20	200
CKR05BX181K_	1224	1264	1304	1344	180	10	200
CKR05BX221K_	1225	1265	1305	1345	220	10	200
CKR05BX221M_	1226	1266	1306	1346	220	20	200
CKR05BX271K_	1227	1267	1307	1347	270	10	200
CKR05BX331K_	1228	1268	1308	1348	330	10	200
CKR05BX331M_	1229	1269	1309	1349	330	20	200
CKR05BX391K_	1230	1270	1310	1350	390	10	200
CKR05BX471K_	1231	1271	1311	1351	470	10	200
CKR05BX471M_	1232	1272	1312	1352	470	20	200
CKR05BX561K_	1233	1273	1313	1353	560	10	200
CKR05BX681K_	1234	1274	1314	1354	680	10	200
CKR05BX681M_	1235	1275	1315	1355	680	20	200
CKR05BX821K_	1236	1276	1316	1356	820	10	200
CKR05BX102K_	1237	1277	1317	1357	1,000	10	200
CKR05BX102M_	1238	1278	1318	1358	1,000	20	200
CKR05BX122K_	1239	1279	1319	1359	1,200	10	100
CKR05BX152K_	1240	1280	1320	1360	1,500	10	100
CKR05BX152M_	1441	1481	1521	1561	1,500	20	100
CKR05BX182K_	1442	1482	1522	1562	1,800	10	100
CKR05BX222K_	1443	1483	1523	1563	2,200	10	100
CKR05BX222M_	1444	1484	1524	1564	2,200	20	100
CKR05BX272K_	1445	1485	1525	1565	2,700	10	100
CKR05BX332K_	1446	1486	1526	1566	3,300	10	100
CKR05BX332M_	1447	1487	1527	1567	3,300	20	100
CKR05BX392K_	1448	1488	1528	1568	3,900	10	100
CKR05BX472K_	1449	1489	1529	1569	4,700	10	100
CKR05BX472M_	1450	1490	1530	1570	4,700	20	100
CKR05BX562K_	1451	1491	1531	1571	5,600	10	100
CKR05BX682K_	1452	1492	1532	1572	6,800	10	100
CKR05BX682M_	1453	1493	1533	1573	6,800	20	100
CKR05BX822K_	1454	1494	1534	1574	8,200	10	100
CKR05BX103K_	1455	1495	1535	1575	10,000	10	100
CKR05BX103M_	1456	1496	1536	1576	10,000	20	100
CKR05BX123K_	1457	1497	1537	1577	12,000	10	50
CKR05BX153K_	1458	1498	1538	1578	15,000	10	50
CKR05BX153M_	1459	1499	1539	1579	15,000	20	50
CKR05BX183K_	1460	1500	1540	1580	18,000	10	50
CKR05BX223K_	1461	1501	1541	1581	22,000	10	50
CKR05BX223M_	1462	1502	1542	1582	22,000	20	50
CKR05BX273K_	1463	1503	1543	1583	27,000	10	50
CKR05BX333K_	1464	1504	1544	1584	33,000	10	50
CKR05BX333M_	1465	1505	1545	1585	33,000	20	50
CKR05BX393K_	1466	1506	1546	1586	39,000	10	50
CKR05BX473K_	1467	1507	1547	1587	47,000	10	50
CKR05BX473M_	1468	1508	1548	1588	47,000	20	50
CKR05BX563K_	1469	1509	1549	1589	56,000	10	50
CKR05BX683K_	1470	1510	1550	1590	68,000	10	50
CKR05BX683M_	1471	1511	1551	1591	68,000	20	50
CKR05BX823K_	1472	1512	1552	1592	82,000	10	50
CKR05BX104K_	1473	1513	1553	1593	100,000	10	50
CKR05BX104M_	1474	1514	1554	1594	100,000	20	50

— Add appropriate failure rate level letter (M, P, R or S)

MILITARY DASH NUMBER IDENTIFICATION CKR06 TO MIL-PRF-39014/02

(Dash Number From Table)

Military Type Designation	Failure Rate Level (%/1,000 Hours)				Capacitance (pF)	Capacitance Tolerance ±Percent	WVDC
	1.0 (M)	0.1 (P)	0.01 (R)	0.001 (S)			
CKR06 (BX)							
CKR06BX122K_	1201	1241	1281	1321	1200	10	200
CKR06BX152K_	1202	1242	1282	1322	1500	10	200
CKR06BX152M_	1203	1243	1283	1323	1500	20	200
CKR06BX182K_	1204	1244	1284	1324	1800	10	200
CKR06BX222K_	1206	1246	1286	1326	2200	10	200
CKR06BX222M_	1207	1247	1287	1327	2200	20	200
CKR06BX272K_	1208	1248	1288	1328	2700	10	200
CKR06BX332K_	1209	1249	1289	1329	3300	10	200
CKR06BX332M_	1210	1250	1290	1330	3300	20	200
CKR06BX392K_	1211	1251	1291	1331	3900	10	200
CKR06BX472K_	1212	1252	1292	1332	4700	10	200
CKR06BX472M_	1213	1253	1293	1333	4700	20	200
CKR06BX562K_	1214	1254	1294	1334	5600	10	200
CKR06BX682K_	1215	1255	1295	1335	6800	10	200
CKR06BX682M_	1216	1256	1296	1336	6800	20	200
CKR06BX822K_	1217	1257	1297	1337	8200	10	200
CKR06BX103K_	1218	1258	1298	1338	10,000	10	200
CKR06BX103M_	1219	1259	1299	1339	10,000	20	200
CKR06BX123K_	1231	1271	1311	1351	12,000	10	100
CKR06BX153K_	1220	1260	1300	1340	15,000	10	100
CKR06BX183K_	1221	1261	1301	1341	18,000	10	100
CKR06BX223K_	1222	1262	1302	1342	22,000	10	100
CKR06BX273K_	1232	1272	1312	1352	27,000	10	100
CKR06BX333K_	1223	1263	1303	1343	33,000	10	100
CKR06BX393K_	1224	1264	1304	1344	39,000	10	100
CKR06BX473K_	1225	1265	1305	1345	47,000	10	100
CKR06BX563K_	1226	1266	1306	1346	56,000	10	100
CKR06BX683K_	1227	1267	1307	1347	68,000	10	100
CKR06BX823K_	1229	1269	1309	1349	82,000	10	100
CKR06BX104K_	1230	1270	1310	1350	100,000	10	100
CKR06BX124K_	1233	1273	1313	1353	120,000	10	50
CKR06BX154K_	1234	1274	1314	1354	150,000	10	50
CKR06BX184K_	1235	1275	1315	1355	180,000	10	50
CKR06BX224K_	1236	1276	1316	1356	220,000	10	50
CKR06BX274K_	1237	1277	1317	1357	270,000	10	50
CKR06BX334K_	1238	1278	1318	1358	330,000	10	50
CKR06BX394K_	1239	1279	1319	1359	390,000	10	50
CKR06BX474K_	1240	1280	1320	1360	470,000	10	50
CKR06BX564K_	1404	1408	1412	1416	560,000	10	50
CKR06BX684K_	1405	1409	1413	1417	680,000	10	50
CKR06BX824K_	1406	1410	1414	1418	820,000	10	50
CKR06BX105K_	1407	1411	1415	1419	1,000,000	10	50

— Add appropriate failure rate level letter (M, P, R or S)

CKR08 TO MIL-PRF-39014/20 (DASH NUMBER FROM TABLE)

Military Type Designation	Failure Rate Level (%/1,000 Hours)	Capacitance (pF)	Capacitance Tolerance ±Percent	WVDC
	1.0 (M)			
CKR08 (BX)				
CKR08BX125K_	0104	1,200,000	10	50
CKR08BX155K_	0105	1,500,000	10	50
CKR08BX205K_	0106	2,000,000	10	50

— Add appropriate failure rate level letter (M)

CROSS REFERENCE CHART - MILITARY FOR MOLDED RADIAL LEAD

Figure	Style	Per Mil-Spec			Case Size				
		MIL-C-11015	MIL-PRF-39014	MIL-PRF-20	Length(L)	Width (W)	Thickness (T)	Lead Spacing (LS)	Lead Diameter (LD)
1	MR05	CK05	CKR05	CCR05/CC05	4.83±.25 (.190±.010)	4.83±.25 (.190±.010)	2.29±.25 (.090±.010)	5.08±.38 (.200±.015)	.64±.05 (.025±.002)
2	MR04	—	CKR04	CCR09/CC09	4.83±.25 (.190±.010)	4.83±.25 (.190±.010)	2.29±.25 (.090±.010)	2.54±.38 (.100±.015)	.64±.05 (.025±.002)
2	MR06	CK06	CKR06	CCR06/CC06	7.37±.25 (.290±.010)	7.37±.25 (.290±.010)	2.29±.25 (.090±.010)	5.08±.38 (.200±.015)	.64±.05 (.025±.002)
2	MR68	—	CKR08	—	7.37±.25 (.290±.010)	7.37±.25 (.290±.010)	3.68±.38 (.145±.015)	5.08±.38 (.200±.015)	.64±.05 (.025±.002)
2	MR07	—	—	CCR07/CC07	12.19±.51 (.480±.020)	12.19±.51 (.480±.020)	3.56±.25 (.140±.010)	10.16±.51 (.400±.020)	.64±.05 (.025±.002)
2	MR08	—	—	CCR08/CC08	12.19±.51 (.480±.020)	12.19±.51 (.480±.020)	6.1±.25 (.240±.010)	10.16±.51 (.400±.020)	.64±.05 (.025±.002)

Dimensions: Millimeters (Inches)

Axial Leads

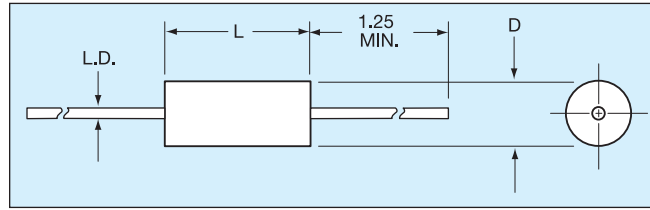

HOW TO ORDER

Military Type Designation: Styles CKR11, CKR12, CKR14, CKR15, CKR16

Dash Number Option: MIL-PRF-39014/05 (Add Appropriate Dash Number)

CKR11

Style

CK= General purpose, ceramic dielectric, fixed capacitors
R = Established Reliability parts
11 = Remaining two numbers identify shape and dimension

BX

Voltage-

Temperature Limits

First letter identifies temperature range.
B = -55°C to +125°C
Second letter identifies voltage-temperature coefficient.

Capacitance Change with Reference to 25°C		
Second Letter	No Voltage	Rated Voltage
R	+15, -15%	+15, -40%
X	+15, -15%	+15, -25%

103

Capacitance

First two digits are the significant figures of capacitance. Third digit indicates the additional number of zeros. For example, order 10,000 pF as 103.

K

Capacitance

Tolerance

K = ±10%
M = ±20%

S

Military

Failure Rate

M = 1% per 1000 hours
P = 0.1% per 1000 hours
R = 0.01% per 1000 hours
S = 0.001% per 1000 hours

Note:

KYOCERA AVX reserves the right to substitute a lower failure rate part per MIL-PRF-39014/5E.

Substitutability for failure rate levels shall be as follows:

Failure Rate Level	Will Replace Failure Rate Level
S (STD) (X-ray)	R, P, M, L
R (STD) (No X-ray)	P, M, L
P	M, L
M	L

Not RoHS Compliant

PACKAGING REQUIREMENTS

Packaging: Bulk

CKR11, 12, & 14 100 pcs per bag
CKR15 & 16 50 pcs per bag

Tape & Reel

CKR11, 12 5000 pcs per reel
CKR14 3000 pcs per reel
CKR15 950 pcs per reel
CKR16 650 pcs per reel

SIZE SPECIFICATIONS

Dimensions: Millimeters (Inches)

Per Mil Spec	Case Size		
	Length (L)	Diameter (D)	Lead Diameter (L.D.)
MIL-PRF-39014			
CKR11	4.07±.25 (.160±.010)	2.29±.25 (.090±.010)	.48±.05 (.019±.002)
CKR12	6.35±.25 (.250±.010)	2.29±.25 (.090±.010)	.48±.05 (.019±.002)
CKR14	9.91±.25 (.390±.010)	3.56±.25 (.140±.010)	.63±.025 (.025±.002)
CKR15	12.7±.51 (.500±.020)	6.35±.38 (.250±.015)	.63±.05 (.025±.002)
CKR16	17.53±.51 (.690±.020)	8.89±.51 (.350±.020)	.63±.05 (.025±.002)

MILITARY DASH NUMBER IDENTIFICATION CKR11 TO MIL-PRF-39014/05

(Dash Number From Table)

Military Type Designation	Failure Rate Level (%/1,000 Hours)				Capacitance (pF)	Capacitance Tolerance ±Percent	WVDC
	1.0 (M)	0.1 (P)	0.01 (R)	0.001 (S)			
CKR11 (BX)							
CKR11BX100K_	2601	2801	2001	2201	10	10	100
CKR11BX100M_	2602	2802	2002	2202	10	20	100
CKR11BX120K_	2603	2803	2003	2203	12	10	100
CKR11BX150K_	2604	2804	2004	2204	15	10	100
CKR11BX150M_	2605	2805	2005	2205	15	20	100
CKR11BX180K_	2606	2806	2006	2206	18	10	100
CKR11BX220K_	2607	2807	2007	2207	22	10	100
CKR11BX220M_	2608	2808	2008	2208	22	20	100
CKR11BX270K_	2609	2809	2009	2209	27	10	100
CKR11BX330K_	2610	2810	2010	2210	33	10	100
CKR11BX330M_	2611	2811	2011	2211	33	20	100
CKR11BX390K_	2612	2812	2012	2212	39	10	100
CKR11BX470K_	2613	2813	2013	2213	47	10	100
CKR11BX470M_	2614	2814	2014	2214	47	20	100
CKR11BX560K_	2615	2815	2015	2215	56	10	100
CKR11BX680K_	2616	2816	2016	2216	68	10	100
CKR11BX680M_	2617	2817	2017	2217	68	20	100
CKR11BX820K_	2618	2818	2018	2218	82	10	100
CKR11BX101K_	2619	2819	2019	2219	100	10	100
CKR11BX101M_	2620	2820	2020	2220	100	20	100
CKR11BX121K_	2621	2821	2021	2221	120	10	100
CKR11BX151K_	2622	2822	2022	2222	150	10	100
CKR11BX151M_	2623	2823	2023	2223	150	20	100
CKR11BX181K_	2624	2824	2024	2224	180	10	100
CKR11BX221K_	2625	2825	2025	2225	220	10	100
CKR11BX221M_	2626	2826	2026	2226	220	20	100
CKR11BX271K_	2627	2827	2027	2227	270	10	100
CKR11BX331K_	2628	2828	2028	2228	330	10	100
CKR11BX331M_	2629	2829	2029	2229	330	20	100
CKR11BX391K_	2630	2830	2030	2230	390	10	100
CKR11BX471K_	2631	2831	2031	2231	470	10	100
CKR11BX471M_	2632	2832	2032	2232	470	20	100
CKR11BX561K_	2633	2833	2033	2233	560	10	100
CKR11BX681K_	2634	2834	2034	2234	680	10	100
CKR11BX681M_	2635	2835	2035	2235	680	20	100
CKR11BX821K_	2636	2836	2036	2236	820	10	100
CKR11BX102K_	2637	2837	2037	2237	1000	10	100
CKR11BX102M_	2638	2838	2038	2238	1000	20	100
CKR11BX122K_	2639	2839	2039	2239	1200	10	100
CKR11BX152K_	2640	2840	2040	2240	1500	10	100
CKR11BX152M_	2641	2841	2041	2241	1500	20	100
CKR11BX182K_	2642	2842	2042	2242	1800	10	100
CKR11BX222K_	2643	2843	2043	2243	2200	10	100
CKR11BX222M_	2644	2844	2044	2244	2200	20	100
CKR11BX272K_	2645	2845	2045	2245	2700	10	100
CKR11BX332K_	2646	2846	2046	2246	3300	10	100
CKR11BX332M_	2647	2847	2047	2247	3300	20	100
CKR11BX392K_	2648	2848	2048	2248	3900	10	100
CKR11BX472K_	2649	2849	2049	2249	4700	10	100
CKR11BX472M_	2650	2850	2050	2250	4700	20	100
CKR11BX562K_	2651	2851	2051	2251	5600	10	50
CKR11BX682K_	2652	2852	2052	2252	6800	10	50
CKR11BX682M_	2653	2853	2053	2253	6800	20	50
CKR11BX822K_	2654	2854	2054	2254	8200	10	50
CKR11BX103K_	2655	2855	2055	2255	10,000	10	50
CKR11BX103M_	2656	2856	2056	2256	10,000	20	50

— Add appropriate failure rate level letter (M, P, R or S)

MILITARY DASH NUMBER IDENTIFICATION CKR12/14/15 TO MIL-PRF-39014/05

(Dash Number From Table)

Military Type Designation	Failure Rate Level (%/1,000 Hours)				Capacitance (pF)	Capacitance Tolerance ±Percent	WVDC
	1.0 (M)	0.1 (P)	0.01 (R)	0.001 (S)			
CKR12 (BX)							
CKR12BX562K_	2657	2857	2057	2257	5600	10	100
CKR12BX682K_	2658	2858	2058	2258	6800	10	100
CKR12BX682M_	2659	2859	2059	2259	6800	20	100
CKR12BX822K_	2660	2860	2060	2260	8200	10	100
CKR12BX103K_	2661	2861	2061	2261	10,000	10	100
CKR12BX103M_	2662	2862	2062	2262	10,000	20	100
CKR12BX123K_	2663	2863	2063	2263	12,000	10	50
CKR12BX153K_	2664	2864	2064	2264	15,000	10	50
CKR12BX153M_	2665	2865	2065	2265	15,000	20	50
CKR12BX183K_	2666	2866	2066	2266	18,000	10	50
CKR12BX223K_	2667	2867	2067	2267	22,000	10	50
CKR12BX223M_	2668	2868	2068	2268	22,000	20	50
CKR12BX273K_	2669	2869	2069	2269	27,000	10	50
CKR12BX333K_	2670	2870	2070	2270	33,000	10	50
CKR12BX333M_	2671	2871	2071	2271	33,000	20	50
CKR12BX393K_	2672	2872	2072	2272	39,000	10	50
CKR12BX473K_	2673	2873	2073	2273	47,000	10	50
CKR12BX473M_	2674	2874	2074	2274	47,000	20	50
CKR14 (BX)							
CKR14BX123K_	2675	2875	2075	2275	12,000	10	100
CKR14BX153K_	2676	2876	2076	2276	15,000	10	100
CKR14BX153M_	2677	2877	2077	2277	15,000	20	100
CKR14BX183K_	2678	2878	2078	2278	18,000	10	100
CKR14BX223K_	2679	2879	2079	2279	22,000	10	100
CKR14BX223M_	2680	2880	2080	2280	22,000	20	100
CKR14BX273K_	2681	2881	2081	2281	27,000	10	100
CKR14BX333K_	2682	2882	2082	2282	33,000	10	100
CKR14BX333M_	2683	2883	2083	2283	33,000	20	100
CKR14BX393K_	2684	2884	2084	2284	39,000	10	100
CKR14BX473K_	2685	2885	2085	2285	47,000	10	100
CKR14BX473M_	2686	2886	2086	2286	47,000	20	100
CKR14BX563K_	2687	2887	2087	2287	56,000	10	50
CKR14BX683K_	2688	2888	2088	2288	68,000	10	50
CKR14BX683M_	2689	2889	2089	2289	68,000	20	50
CKR14BX823K_	2690	2890	2090	2290	82,000	10	50
CKR14BX104K_	2691	2891	2091	2291	100,000	10	50
CKR14BX104M_	2692	2892	2092	2292	100,000	20	50
CKR14 (BR)							
CKR14BR563K_	2693	2893	2093	2293	56,000	10	100
CKR14BR683K_	2694	2894	2094	2294	68,000	10	100
CKR14BR683M_	2695	2895	2095	2295	68,000	20	100
CKR14BR823K_	2696	2896	2096	2296	82,000	10	100
CKR14BR104K_	2697	2897	2097	2297	100,000	10	100
CKR14BR104M_	2698	2898	2098	2298	100,000	20	100
CKR14BR124K_	2699	2899	2099	2299	120,000	10	50
CKR14BR154K_	2700	2900	2100	2300	150,000	10	50
CKR14BR154M_	2701	2901	2101	2301	150,000	20	50
CKR14BR184K_	2702	2902	2102	2302	180,000	10	50
CKR14BR224K_	2703	2903	2103	2303	220,000	10	50
CKR14BR224M_	2704	2904	2104	2304	220,000	20	50
CKR14BR274K_	2705	2905	2105	2305	270,000	10	50
CKR15 (BX)							
CKR15BX563K_	2706	2906	2106	2306	56,000	10	100
CKR15BX683K_	2707	2907	2107	2307	68,000	10	100
CKR15BX683M_	2708	2908	2108	2308	68,000	20	100
CKR15BX823K_	2709	2909	2109	2309	82,000	10	100
CKR15BX104K_	2710	2910	2110	2310	100,000	10	100
CKR15BX104M_	2711	2911	2111	2311	100,000	20	100

— Add appropriate failure rate level letter (M, P, R or S)

MILITARY DASH NUMBER IDENTIFICATION CKR15/16 TO MIL-PRF-39014/05

(Dash Number From Table)

Military Type Designation	Failure Rate Level (%/1,000 Hours)				Capacitance (pF)	Capacitance Tolerance ±Percent	WVDC
	1.0 (M)	0.1 (P)	0.01 (R)	0.001 (S)			
CKR15 (BR)							
CKR15BR124K_	2712	2912	2112	2312	120,000	10	100
CKR15BR154K_	2713	2913	2113	2313	150,000	10	100
CKR15BR154M_	2714	2914	2114	2314	150,000	20	100
CKR15BR184K_	2715	2915	2115	2315	180,000	10	100
CKR15BR224K_	2716	2916	2116	2316	220,000	10	100
CKR15BR224M_	2717	2917	2117	2317	220,000	20	100
CKR15BR274K_	2718	2918	2118	2318	270,000	10	100
CKR15BR334K_	2719	2919	2119	2319	330,000	10	100
CKR15BR334M_	2720	2920	2120	2320	330,000	20	100
CKR15BR474K_	2721	2921	2121	2321	470,000	10	50
CKR15BR474M_	2722	2922	2122	2322	470,000	20	50
CKR15BR684K_	2723	2923	2123	2323	680,000	10	50
CKR15BR684M_	2724	2924	2124	2324	680,000	20	50
CKR15BR105K_	2725	2925	2125	2325	1,000,000	10	50
CKR15BR105M_	2726	2926	2126	2326	1,000,000	20	50
CKR16 (BR)							
CKR16BR474K_	2727	2927	2127	2327	470,000	10	100
CKR16BR474M_	2728	2928	2128	2328	470,000	20	100
CKR16BR684K_	2729	2929	2129	2329	680,000	10	100
CKR16BR684M_	2730	2930	2130	2330	680,000	20	100
CKR16BR105K_	2731	2931	2131	2331	1,000,000	10	100
CKR16BR105M_	2732	2932	2132	2332	1,000,000	20	100
CKR16BR225K_	2733	2933	2133	2333	2,200,000	10	50
CKR16BR225M_	2734	2934	2134	2334	2,200,000	20	50
CKR16BR335K_	2735	2935	2135	2335	3,300,000	10	50
CKR16BR335M_	2736	2936	2136	2336	3,300,000	20	50

_____ Add appropriate failure rate level letter (M, P, R or S)

MARKING

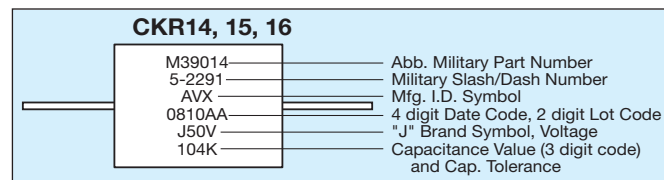
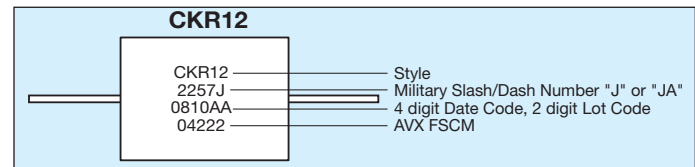
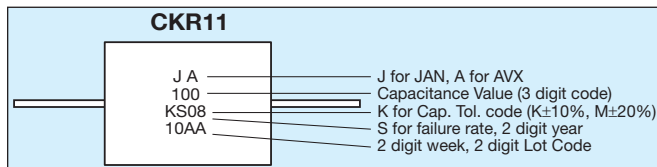

CROSS REFERENCE CHART - MILITARY FOR MOLDED AXIAL LEAD

Style	Per Mil-Spec			Case Size		
	MIL-C-11015	MIL-PRF-39014	MIL-PRF-20	Length (L)	Diameter (D)	Lead Diameter (L.D.)
MA10	CK12	CKR11	CCR75/CC75	4.07 ±.25 (.160±.010)	2.29±.25 (.090±.010)	.48±.05 (.019±.002)
MA20	CK13	CKR12	CCR76/CC76	6.35 ±.25 (.250 ±.010)	2.29±.25 (.090±.010)	.48±.05 (.019±.002)
MA30	—	—	—	6.10 ±.25 (.240±.010)	3.30±.25 (.130±.010)	.48±.05 (.019±.002)
MA40	CK14	CKR14	CCR77/CC77	9.91±.25 (.390±.010)	3.56±.25 (.140±.010)	.63±.05 (.025±.002)
MA50	CK15	CKR15	CCR78/CC78	12.7±.51 (.500±.020)	6.35±.38 (.250±.015)	.63±.05 (.025±.002)
MA60	CK16	CKR16	CCR79/CC79	17.53±.51 (.690±.020)	8.89±.51 (.350±.015)	.63±.05 (.025±.002)

Dimensions: Millimeters (Inches)

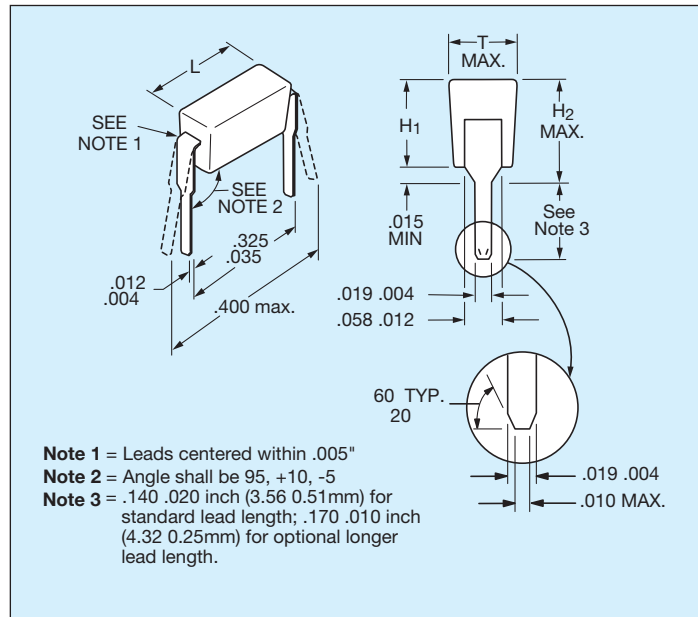

HOW TO ORDER

Military Type Designation: Styles CKR22, CKR23, CKR24

Dash Number Option: MIL-PRF-39014/22 (Add Appropriate Dash Number)

CKR22

Style

CK = General purpose, ceramic dielectric, fixed capacitors
 R = Established Reliability parts
 22 = Remaining two numbers identify shape and dimension

BX

Voltage-

Temperature Limits

First letter identifies temperature range.
 B = -55°C to +125°C
 C = -55°C to +125°C
 Second letter identifies voltage-temperature coefficient.

Capacitance Change with Reference to 25°C		
Second Letter	No Voltage	Rated Voltage
G	+30, -30ppm	+30, -30ppm
H	+60, -60ppm	+60, -60ppm
R	+15, -15%	+15, -40%
X	+15, -15%	+15, -25%

104

Capacitance

First two digits are the significant figures of capacitance. Third digit indicates the additional number of zeros. For example, order 100,000 pF as 104. (For values below 10pF use "R" in place of decimal point, e.g., 1R5 = 1.5pF.)

K

Capacitance Tolerance

D = ±.5pF
 F = ±1%
 J = ±5%
 K = ±10%
 M = ±20%

R

Military Failure Rate

M = 1% per 1000 hours
 P = 0.1% per 1000 hours
 R = 0.01% per 1000 hours
 S = 0.001% per 1000 hours
 Note:

KYOCERA AVX reserves the right to substitute a lower failure rate part per MIL-PRF-39014. Substitutability for failure rate levels shall be as follows:

Failure Rate Level	Will Replace Failure Rate Level
S (STD) (X-ray)	R, P, M, L
R (STD) (No X-ray)	P, M, L
P	M, L
M	L

Not RoHS Compliant

PACKAGING REQUIREMENTS

Packaging: MD01/MD02: 200 pcs/slide pack. See page 35.
 MD03: 200 pcs per vial.
 200 pcs per slide pack upon request.

SIZE SPECIFICATIONS

Dimensions: Millimeters (Inches)

MIL-PRF-39014	Length (L)	Height (H ₁)	Height (H ₂)	Thickness
CKR22	6.60 (.260 ±.020)	3.25 (.128 ±.007)	4.45 max. (.175)	2.34 (.092 ±.006)
CKR23	6.60 (.260 ±.020)	3.94 (.155 ±.007)	4.95 max. (.195)	2.34 (.092 ±.006)
CKR24	6.60 (.260 ±.020)	7.19 (.283 ±.007)	8.13 max. (.320)	2.34 (.092 ±.006)

MILITARY DASH NUMBER IDENTIFICATION CKR22 TO MIL-PRF-39014/22

(Dash Number From Table)

Military Type Designation	Failure Rate Level (%/1,000 Hours)								Capacitance (pF)	Capacitance Tolerance	WVDC	
	Standard Lead Length				Optional Longer Lead Length							
	1.0 (M)	0.1 (P)	0.01 (R)	0.001 (S)	1.0 (M)	0.1 (P)	0.01 (R)	0.001 (S)				
Style CKR22, Voltage-temperature limits of 0 ± 60 ppm/°C.												
CKR22CH1R0D_	0001	0301	0601	0901	3001	3301	3601	3901	1.0	D	200	
CKR22CH1R2D_	0004	0304	0604	0904	3004	3304	3604	3904	1.2	D		
CKR22CH1R5D_	0007	0307	0607	0907	3007	3307	3607	3907	1.5	D		
CKR22CH1R8D_	0010	0310	0610	0910	3010	3310	3610	3910	1.8	D		
CKR22CH2R2D_	0013	0313	0613	0913	3013	3313	3613	3913	2.2	D		
CKR22CH2R7D_	0016	0316	0616	0916	3016	3316	3616	3916	2.7	D		
CKR22CH3R3D_	0019	0319	0619	0919	3019	3319	3619	3919	3.3	D		
CKR22CH3R9D_	0022	0322	0622	0922	3022	3322	3622	3922	3.9	D		
CKR22CH4R7D_	0025	0325	0625	0925	3025	3325	3625	3925	4.7	D		
CKR22CH5R6D_	0028	0328	0628	0928	3028	3328	3628	3928	5.6	D		
CKR22CH6R8D_	0031	0331	0631	0931	3031	3331	3631	3931	6.8	D		
CKR22CH8R2D_	0034	0334	0634	0934	3034	3334	3634	3934	8.2	D		
CKR22CH100D_	0037	0337	0637	0937	3037	3337	3637	3937	10	D		
CKR22CH100J_	0038	0338	0638	0938	3038	3338	3638	3938	10	J		
CKR22CH100K_	0039	0339	0639	0939	3039	3339	3639	3939	10	K		
CKR22CH120D_	0040	0340	0640	0940	3040	3340	3640	3940	12	D		
CKR22CH120J_	0041	0341	0641	0941	3041	3341	3641	3941	12	J		
CKR22CH120K_	0042	0342	0642	0942	3042	3342	3642	3942	12	K		
CKR22CH150D_	0043	0343	0643	0943	3043	3343	3643	3943	15	D		
CKR22CH150J_	0044	0344	0644	0944	3044	3344	3644	3944	15	J		
CKR22CH150K_	0045	0345	0645	0945	3045	3345	3645	3945	15	K		
CKR22CH180D_	0046	0346	0646	0946	3046	3346	3646	3946	18	D		
CKR22CH180J_	0047	0347	0647	0947	3047	3347	3647	3947	18	J		
CKR22CH180K_	0048	0348	0648	0948	3048	3348	3648	3948	18	K		
Style CKR22, Voltage-temperature limits of ±30 ppm/°C,												
CKR22CG220D_	0049	0349	0649	0949	3049	3349	3649	3949	22	D		200
CKR22CG220J_	0050	0350	0650	0950	3050	3350	3650	3950	22	J		
CKR22CG220K_	0051	0351	0651	0951	3051	3351	3651	3951	22	K		
CKR22CG270D_	0052	0352	0652	0952	3052	3352	3652	3952	27	D		
CKR22CG270J_	0053	0353	0653	0953	3053	3353	3653	3953	27	J		
CKR22CG270K_	0054	0354	0654	0954	3054	3354	3654	3954	27	K		
CKR22CG330D_	0055	0355	0655	0955	3055	3355	3655	3955	33	D		
CKR22CG330J_	0056	0356	0656	0956	3056	3356	3656	3956	33	J		
CKR22CG330K_	0057	0357	0657	0957	3057	3357	3657	3957	33	K		
CKR22CG390D_	0058	0358	0658	0958	3058	3358	3658	3958	39	D		
CKR22CG390J_	0059	0359	0659	0959	3059	3359	3659	3959	39	J		
CKR22CG390K_	0060	0360	0660	0960	3060	3360	3660	3960	39	K		
CKR22CG470D_	0061	0361	0661	0961	3061	3361	3661	3961	47	D		
CKR22CG470J_	0062	0362	0662	0962	3062	3362	3662	3962	47	J		
CKR22CG470K_	0063	0363	0663	0963	3063	3363	3663	3963	47	K		
CKR22CG560D_	0064	0364	0664	0964	3064	3364	3664	3964	56	D		
CKR22CG560J_	0065	0365	0665	0965	3065	3365	3665	3965	56	J		
CKR22CG560K_	0066	0366	0666	0966	3066	3366	3666	3966	56	K		
CKR22CG680F_	0067	0367	0667	0967	3067	3367	3667	3967	68	F		
CKR22CG680J_	0068	0368	0668	0968	3068	3368	3668	3968	68	J		
CKR22CG680K_	0069	0369	0669	0969	3069	3369	3669	3969	68	K		
CKR22CG820F_	0070	0370	0670	0970	3070	3370	3670	3970	82	F		
CKR22CG820J_	0071	0371	0671	0971	3071	3371	3671	3971	82	J		
CKR22CG820K_	0072	0372	0672	0972	3072	3372	3672	3972	82	K		
CKR22CG101F_	0073	0373	0673	0973	3073	3373	3673	3973	100	F		
CKR22CG101J_	0074	0374	0674	0974	3074	3374	3674	3974	100	J		
CKR22CG101K_	0075	0375	0675	0975	3075	3375	3675	3975	100	K		
CKR22CG121F_	0076	0376	0676	0976	3076	3376	3676	3976	120	F		
CKR22CG121J_	0077	0377	0677	0977	3077	3377	3677	3977	120	J		
CKR22CG121K_	0078	0378	0678	0978	3078	3378	3678	3978	120	K		
CKR22CG151F_	0079	0379	0679	0979	3079	3379	3679	3979	150	F		
CKR22CG151J_	0080	0380	0680	0980	3080	3380	3680	3980	150	J		
CKR22CG151K_	0081	0381	0681	0981	3081	3381	3681	3981	150	K		
CKR22CG181F_	0082	0382	0682	0982	3082	3382	3682	3982	180	F		
CKR22CG181J_	0083	0383	0683	0983	3083	3383	3683	3983	180	J		
CKR22CG181K_	0084	0384	0684	0984	3084	3384	3684	3984	180	K		
CKR22CG221F_	0085	0385	0685	0985	3085	3385	3685	3985	220	F		
CKR22CG221J_	0086	0386	0686	0986	3086	3386	3686	3986	220	J		
CKR22CG221K_	0087	0387	0687	0987	3087	3387	3687	3987	220	K		
CKR22CG271F_	0088	0388	0688	0988	3088	3388	3688	3988	270	F		
CKR22CG271J_	0089	0389	0689	0989	3089	3389	3689	3989	270	J		

— Add appropriate failure rate level letter (M, P, R or S)

MILITARY DASH NUMBER IDENTIFICATION CKR22 TO MIL-PRF-39014/22

(Dash Number From Table)

Military Type Designation	Failure Rate Level (%/1,000 Hours)								Capacitance (pF)	Capacitance Tolerance	WVDC
	Standard Lead Length				Optional Longer Lead Length						
	1.0 (M)	0.1 (P)	0.01 (R)	0.001 (S)	1.0 (M)	0.1 (P)	0.01 (R)	0.001 (S)			
Style CKR22, Voltage-temperature limits of ±30 ppm/°C, (continued)											
CKR22CG271K_	0090	0390	0690	0990	3090	3390	3690	3990	270	K	200
CKR22CG331F_	0091	0391	0691	0991	3091	3391	3691	3991	330	F	
CKR22CG331J_	0092	0392	0692	0992	3092	3392	3692	3992	330	J	
CKR22CG331K_	0093	0393	0693	0993	3093	3393	3693	3993	330	K	
CKR22CG391F_	0094	0394	0694	0994	3094	3394	3694	3994	390	F	
CKR22CG391J_	0095	0395	0695	0995	3095	3395	3695	3995	390	J	
CKR22CG391K_	0096	0396	0696	0996	3096	3396	3696	3996	390	K	
CKR22CG471F_	0097	0397	0697	0997	3097	3397	3697	3997	470	F	
CKR22CG471J_	0098	0398	0698	0998	3098	3398	3698	3998	470	J	
CKR22CG471K_	0099	0399	0699	0999	3099	3399	3699	3999	470	K	
CKR22CG561F_	0100	0400	0700	1000	3100	3400	3700	4000	560	F	
CKR22CG561J_	0101	0401	0701	1001	3101	3401	3701	4001	560	J	
CKR22CG561K_	0102	0402	0702	1002	3102	3402	3702	4002	560	K	
CKR22CG681F_	0103	0403	0703	1003	3103	3403	3703	4003	680	F	
CKR22CG681J_	0104	0404	0704	1004	3104	3404	3704	4004	680	J	
CKR22CG681K_	0105	0405	0705	1005	3105	3405	3705	4005	680	K	
CKR22CG821F_	0106	0406	0706	1006	3106	3406	3706	4006	820	F	
CKR22CG821J_	0107	0407	0707	1007	3107	3407	3707	4007	820	J	
CKR22CG821K_	0108	0408	0708	1008	3108	3408	3708	4008	820	K	
CKR22CG102F_	0109	0409	0709	1009	3109	3409	3709	4009	1000	F	
CKR22CG102J_	0110	0410	0710	1010	3110	3410	3710	4010	1000	J	
CKR22CG102K_	0111	0411	0711	1011	3111	3411	3711	4011	1000	K	
CKR22CG122F_	0112	0412	0712	1012	3112	3412	3712	4012	1200	F	
CKR22CG122J_	0113	0413	0713	1013	3113	3413	3713	4013	1200	J	
CKR22CG122K_	0114	0414	0714	1014	3114	3414	3714	4014	1200	K	
CKR22CG152F_	0115	0415	0715	1015	3115	3415	3715	4015	1500	F	
CKR22CG152J_	0116	0416	0716	1016	3116	3416	3716	4016	1500	J	
CKR22CG152K_	0117	0417	0717	1017	3117	3417	3717	4017	1500	K	
CKR22CG182F_	0118	0418	0718	1018	3118	3418	3718	4018	1800	F	
CKR22CG182J_	0119	0419	0719	1019	3119	3419	3719	4019	1800	J	
CKR22CG182K_	0120	0420	0720	1020	3120	3420	3720	4020	1800	K	
CKR22CG222F_	0121	0421	0721	1021	3121	3421	3721	4021	2200	F	
CKR22CG222J_	0122	0422	0722	1022	3122	3422	3722	4022	2200	J	
CKR22CG222K_	0123	0423	0723	1023	3123	3423	3723	4023	2200	K	
CKR22CG272F_	0124	0424	0724	1024	3124	3424	3724	4024	2700	F	
CKR22CG272J_	0125	0425	0725	1025	3125	3425	3725	4025	2700	J	
CKR22CG272K_	0126	0426	0726	1026	3126	3426	3726	4026	2700	K	
CKR22CG332F_	0127	0427	0727	1027	3127	3427	3727	4027	3300	F	
CKR22CG332J_	0128	0428	0728	1028	3128	3428	3728	4028	3300	J	
CKR22CG332K_	0129	0429	0729	1029	3129	3429	3729	4029	3300	K	
CKR22CG392F_	0130	0430	0730	1030	3130	3430	3730	4030	3900	F	
CKR22CG392J_	0131	0431	0731	1031	3131	3431	3731	4031	3900	J	
CKR22CG392K_	0132	0432	0732	1032	3132	3432	3732	4032	3900	K	
CKR22CG472F_	0133	0433	0733	1033	3133	3433	3733	4033	4700	F	
CKR22CG472J_	0134	0434	0734	1034	3134	3434	3734	4034	4700	J	
CKR22CG472K_	0135	0435	0735	1035	3135	3435	3735	4035	4700	K	
CKR22CG562F_	0136	0436	0736	1036	3136	3436	3736	4036	5600	F	
CKR22CG562J_	0137	0437	0737	1037	3137	3437	3737	4037	5600	J	
CKR22CG562K_	0138	0438	0738	1038	3138	3438	3738	4038	5600	K	
CKR22CG682F_	0139	0439	0739	1039	3139	3439	3739	4039	6800	F	
CKR22CG682J_	0140	0440	0740	1040	3140	3440	3740	4040	6800	J	
CKR22CG682K_	0141	0441	0741	1041	3141	3441	3741	4041	6800	K	
CKR22CG822F_	0142	0442	0742	1042	3142	3442	3742	4042	8200	F	
CKR22CG822J_	0143	0443	0743	1043	3143	3443	3743	4043	8200	J	
CKR22CG822K_	0144	0444	0744	1044	3144	3444	3744	4044	8200	K	
CKR22CG103F_	0145	0445	0745	1045	3145	3445	3745	4045	10,000	F	
CKR22CG103J_	0146	0446	0746	1046	3146	3446	3746	4046	10,000	J	
CKR22CG103K_	0147	0447	0747	1047	3147	3447	3747	4047	10,000	K	

— Add appropriate failure rate level letter (M, P, R or S)

MILITARY DASH NUMBER IDENTIFICATION CKR22 TO MIL-PRF-39014/22

(Dash Number From Table)

Military Type Designation	Failure Rate Level (%/1,000 Hours)								Capacitance (pF)	Capacitance Tolerance	WVDC
	Standard Lead Length				Optional Longer Lead Length						
	1.0 (M)	0.1 (P)	0.01 (R)	0.001 (S)	1.0 (M)	0.1 (P)	0.01 (R)	0.001 (S)			
Style CKR22, Voltage-temperature limits of ±15% (+15%, -25% for Rated Voltage)											
CKR22BX271K_	0148	0448	0748	1048	3148	3448	3748	4048	270	K	200
CKR22BX331K_	0149	0449	0749	1049	3149	3449	3749	4049	330	K	
CKR22BX331M_	0150	0450	0750	1050	3150	3450	3750	4050	330	M	
CKR22BX391K_	0151	0451	0751	1051	3151	3451	3751	4051	390	K	
CKR22BX471K_	0152	0452	0752	1052	3152	3452	3752	4052	470	K	
CKR22BX471M_	0153	0453	0753	1053	3153	3453	3753	4053	470	M	
CKR22BX561K_	0154	0454	0754	1054	3154	3454	3754	4054	560	K	
CKR22BX681K_	0155	0455	0755	1055	3155	3455	3755	4055	680	K	
CKR22BX681M_	0156	0456	0756	1056	3156	3456	3756	4056	680	M	
CKR22BX821K_	0157	0457	0757	1057	3157	3457	3757	4057	820	K	
CKR22BX102K_	0158	0458	0758	1058	3158	3458	3758	4058	1,000	K	100
CKR22BX102M_	0159	0459	0759	1059	3159	3459	3759	4059	1,000	M	
CKR22BX122K_	0160	0460	0760	1060	3160	3460	3760	4060	1,200	K	
CKR22BX152K_	0161	0461	0761	1061	3161	3461	3761	4061	1,500	K	
CKR22BX152M_	0162	0462	0762	1062	3162	3462	3762	4062	1,500	M	
CKR22BX182K_	0163	0463	0763	1063	3163	3463	3763	4063	1,800	K	
CKR22BX222K_	0164	0464	0764	1064	3164	3464	3764	4064	2,200	K	
CKR22BX222M_	0165	0465	0765	1065	3165	3465	3765	4065	2,200	M	
CKR22BX272K_	0166	0466	0766	1066	3166	3466	3766	4066	2,700	K	
CKR22BX332K_	0167	0467	0767	1067	3167	3467	3767	4067	3,300	K	
CKR22BX332M_	0168	0468	0768	1068	3168	3468	3768	4068	3,300	M	50
CKR22BX392K_	0169	0469	0769	1069	3169	3469	3769	4069	3,900	K	
CKR22BX472K_	0170	0470	0770	1070	3170	3470	3770	4070	4,700	K	
CKR22BX472M_	0171	0471	0771	1071	3171	3471	3771	4071	4,700	M	
CKR22BX562K_	0172	0472	0772	1072	3172	3472	3772	4072	5,600	K	
CKR22BX682K_	0173	0473	0773	1073	3173	3473	3773	4073	6,800	K	
CKR22BX682M_	0174	0474	0774	1074	3174	3474	3774	4074	6,800	M	
CKR22BX822K_	0175	0475	0775	1075	3175	3475	3775	4075	8,200	K	
CKR22BX103K_	0176	0476	0776	1076	3176	3476	3776	4076	10,000	K	
CKR22BX103M_	0177	0477	0777	1077	3177	3477	3777	4077	10,000	M	
CKR22BX123K_	0178	0478	0778	1078	3178	3478	3778	4078	12,000	K	50
CKR22BX153K_	0179	0479	0779	1079	3179	3479	3779	4079	15,000	K	
CKR22BX153M_	0180	0480	0780	1080	3180	3480	3780	4080	15,000	M	
CKR22BX183K_	0181	0481	0781	1081	3181	3481	3781	4081	18,000	K	
CKR22BX223K_	0182	0482	0782	1082	3182	3482	3782	4082	22,000	K	
CKR22BX223M_	0183	0483	0783	1083	3183	3483	3783	4083	22,000	M	
CKR22BX273K_	0184	0484	0784	1084	3184	3484	3784	4084	27,000	K	
CKR22BX333K_	0185	0485	0785	1085	3185	3485	3785	4085	33,000	K	
CKR22BX333M_	0186	0486	0786	1086	3186	3486	3786	4086	33,000	M	
CKR22BX393K_	0187	0487	0787	1087	3187	3487	3787	4087	39,000	K	
CKR22BX473K_	0188	0488	0788	1088	3188	3488	3788	4088	47,000	K	50
CKR22BX473M_	0189	0489	0789	1089	3189	3489	3789	4089	47,000	M	
CKR22BX563K_	0190	0490	0790	1090	3190	3490	3790	4090	56,000	K	
CKR22BX683K_	0191	0491	0791	1091	3191	3491	3791	4091	68,000	K	
CKR22BX683M_	0192	0492	0792	1092	3192	3492	3792	4092	68,000	M	
CKR22BX823K_	0193	0493	0793	1093	3193	3493	3793	4093	82,000	K	
CKR22BX104K_	0194	0494	0794	1094	3194	3494	3794	4094	100,000	K	
CKR22BX104M_	0195	0495	0795	1095	3195	3495	3795	4095	100,000	M	

Add appropriate failure rate level letter (M, P, R or S)

MILITARY DASH NUMBER IDENTIFICATION CKR23 TO MIL-PRF-39014/22

(Dash Number From Table)

Military Type Designation	Failure Rate Level (%/1,000 Hours)								Capacitance (pF)	Capacitance Tolerance	WVDC	
	Standard Lead Length				Optional Longer Lead Length							
	1.0 (M)	0.1 (P)	0.01 (R)	0.001 (S)	1.0 (M)	0.1 (P)	0.01 (R)	0.001 (S)				
Style CKR23, Voltage-temperature limits of 0 ± 60 ppm/°C												
CKR23CG561F_	0258	0558	0858	1158	3258	3558	3858	4158	560	F	200 ↓ 100 ↓ 50	
CKR23CG561J_	0259	0559	0859	1159	3259	3559	3859	4159	560	J		
CKR23CG561K_	0260	0560	0860	1160	3260	3560	3860	4160	560	K		
CKR23CG681F_	0261	0561	0861	1161	3261	3561	3861	4161	680	F		
CKR23CG681J_	0262	0562	0862	1162	3262	3562	3862	4162	680	J		
CKR23CG681K_	0263	0563	0863	1163	3263	3563	3863	4163	680	K		
CKR23CG821F_	0264	0564	0864	1164	3264	3564	3864	4164	820	F		
CKR23CG821J_	0265	0565	0865	1165	3265	3565	3865	4165	820	J		
CKR23CG821K_	0266	0566	0866	1166	3266	3566	3866	4166	820	K		
CKR23CG102F_	0267	0567	0867	1167	3267	3567	3867	4167	1,000	F		
CKR23CG102J_	0268	0568	0868	1168	3268	3568	3868	4168	1,000	J		
CKR23CG102K_	0269	0569	0869	1169	3269	3569	3869	4169	1,000	K		
CKR23CG122F_	0270	0570	0870	1170	3270	3570	3870	4170	1,200	F		
CKR23CG122J_	0271	0571	0871	1171	3271	3571	3871	4171	1,200	J		
CKR23CG122K_	0272	0572	0872	1172	3272	3572	3872	4172	1,200	K		
CKR23CG272F_	0273	0573	0873	1173	3273	3573	3873	4173	2,700	F		
CKR23CG272J_	0274	0574	0874	1174	3274	3574	3874	4174	2,700	J		
CKR23CG272K_	0275	0575	0875	1175	3275	3575	3875	4175	2,700	K		
CKR23CG332F_	0276	0576	0876	1176	3276	3576	3876	4176	3,300	F		
CKR23CG332J_	0277	0577	0877	1177	3277	3577	3877	4177	3,300	J		
CKR23CG332K_	0278	0578	0878	1178	3278	3578	3878	4178	3,300	K		
CKR23CG472F_	0279	0579	0879	1179	3279	3579	3879	4179	4,700	F		
CKR23CG472J_	0280	0580	0880	1180	3280	3580	3880	4180	4,700	J		
CKR23CG472K_	0281	0581	0881	1181	3281	3581	3881	4181	4,700	K		
CKR23CG562F_	0282	0582	0882	1182	3282	3582	3882	4182	5,600	F		
CKR23CG562J_	0283	0583	0883	1183	3283	3583	3883	4183	5,600	J		
CKR23CG562K_	0284	0584	0884	1184	3284	3584	3884	4184	5,600	K		
CKR23CG682F_	0285	0585	0885	1185	3285	3585	3885	4185	6,800	F		
CKR23CG682J_	0286	0586	0886	1186	3286	3586	3886	4186	6,800	J		
CKR23CG682K_	0287	0587	0887	1187	3287	3587	3887	4187	6,800	K		
CKR23CG822F_	0288	0588	0888	1188	3288	3588	3888	4188	8,200	F		
CKR23CG822J_	0289	0589	0889	1189	3289	3589	3889	4189	8,200	J		
CKR23CG822K_	0290	0590	0890	1190	3290	3590	3890	4190	8,200	K		
CKR23CG103F_	0291	0591	0891	1191	3291	3591	3891	4191	10,000	F		
CKR23CG103J_	0292	0592	0892	1192	3292	3592	3892	4192	10,000	J		
CKR23CG103K_	0293	0593	0893	1193	3293	3593	3893	4193	10,000	K		
Style CKR23, voltage-temperature limits of ±15% (+15%, -25% for Rated Voltage)												
CKR23BX102K_	0196	0496	0796	1096	3196	3496	3796	4096	1,000	K		200 ↓ 100 ↓ 50
CKR23BX102M_	0197	0497	0797	1097	3197	3497	3797	4097	1,000	M		
CKR23BX122K_	0198	0498	0798	1098	3198	3498	3798	4098	1,200	K		
CKR23BX152K_	0199	0499	0799	1099	3199	3499	3799	4099	1,500	K		
CKR23BX152M_	0200	0500	0800	1100	3200	3500	3800	4100	1,500	M		
CKR23BX182K_	0201	0501	0801	1101	3201	3501	3801	4101	1,800	K		
CKR23BX222K_	0202	0502	0802	1102	3202	3502	3802	4102	2,200	K		
CKR23BX222M_	0203	0503	0803	1103	3203	3503	3803	4103	2,200	M		
CKR23BX272K_	0204	0504	0804	1104	3204	3504	3804	4104	2,700	K		
CKR23BX332K_	0205	0505	0805	1105	3205	3505	3805	4105	3,300	K		
CKR23BX332M_	0206	0506	0806	1106	3206	3506	3806	4106	3,300	M		
CKR23BX392K_	0207	0507	0807	1107	3207	3507	3807	4107	3,900	K		
CKR23BX472K_	0208	0508	0808	1108	3208	3508	3808	4108	4,700	K		
CKR23BX472M_	0209	0509	0809	1109	3209	3509	3809	4109	4,700	M		
CKR23BX562K_	0210	0510	0810	1110	3210	3510	3810	4110	5,600	K		
CKR23BX682K_	0211	0511	0811	1111	3211	3511	3811	4111	6,800	K		
CKR23BX682M_	0212	0512	0812	1112	3212	3512	3812	4112	6,800	M		
CKR23BX822K_	0213	0513	0813	1113	3213	3513	3813	4113	8,200	K		
CKR23BX103K_	0214	0514	0814	1114	3214	3514	3814	4114	10,000	K		
CKR23BX103M_	0215	0515	0815	1115	3215	3515	3815	4115	10,000	M		
CKR23BX123K_	0216	0516	0816	1116	3216	3516	3816	4116	12,000	K		
CKR23BX153K_	0217	0517	0817	1117	3217	3517	3817	4117	15,000	K		
CKR23BX153M_	0218	0518	0818	1118	3218	3518	3818	4118	15,000	M		
CKR23BX183K_	0219	0519	0819	1119	3219	3519	3819	4119	18,000	K		
CKR23BX223K_	0220	0520	0820	1120	3220	3520	3820	4120	22,000	K		
CKR23BX223M_	0221	0521	0821	1121	3221	3521	3821	4121	22,000	M		
CKR23BX273K_	0222	0522	0822	1122	3222	3522	3822	4122	27,000	K		
CKR23BX333K_	0223	0523	0823	1123	3223	3523	3823	4123	33,000	K		
CKR23BX333M_	0224	0524	0824	1124	3224	3524	3824	4124	33,000	M		
CKR23BX393K_	0225	0525	0825	1125	3225	3525	3825	4125	39,000	K		
CKR23BX473K_	0226	0526	0826	1126	3226	3526	3826	4126	47,000	K		
CKR23BX473M_	0227	0527	0827	1127	3227	3527	3827	4127	47,000	M		
CKR23BX563K_	0228	0528	0828	1128	3228	3528	3828	4128	56,000	K		
CKR23BX683K_	0229	0529	0829	1129	3229	3529	3829	4129	68,000	K		
CKR23BX683M_	0230	0530	0830	1130	3230	3530	3830	4130	68,000	M		
CKR23BX823K_	0231	0531	0831	1131	3231	3531	3831	4131	82,000	K		
CKR23BX104K_	0232	0532	0832	1132	3232	3532	3832	4132	100,000	K		
CKR23BX104M_	0233	0533	0833	1133	3233	3533	3833	4133	100,000	M		
CKR23BX124K_	0234	0534	0834	1134	3234	3534	3834	4134	120,000	K		
CKR23BX154K_	0235	0535	0835	1135	3235	3535	3835	4135	150,000	K		
CKR23BX154M_	0236	0536	0836	1136	3236	3536	3836	4136	150,000	M		
CKR23BX184K_	0237	0537	0837	1137	3237	3537	3837	4137	180,000	K		
CKR23BX224K_	0238	0538	0838	1138	3238	3538	3838	4138	220,000	K		
CKR23BX224M_	0239	0539	0839	1139	3239	3539	3839	4139	220,000	M		

_____ Add appropriate failure rate level letter (M, P, R or S)

MILITARY DASH NUMBER IDENTIFICATION CKR24 TO MIL-PRF-39014/22

(Dash Number From Table)

Military Type Designation	Failure Rate Level (%/1,000 Hours)								Capacitance (pF)	Capacitance Tolerance	WVDC
	Standard Lead Length				Optional Longer Lead Length						
	1.0 (M)	0.1 (P)	0.01 (R)	0.001 (S)	1.0 (M)	0.1 (P)	0.01 (R)	0.001 (S)			
Style CKR24, Characteristic BX (Voltage-temperature limits of ±15% and +15%, -25%)											
CKR24BX274K_	0294	0594	0894	1194	3294	3594	3894	4194	270000	K	50
CKR24BX274K_	0295	0595	0895	1195	3295	3595	3895	4195	270000	M	
CKR24BX334K_	0296	0596	0896	1196	3296	3596	3896	4196	330000	K	
CKR24BX334M_	0297	0597	0897	1197	3297	3597	3897	4197	330000	M	
CKR24BX394K_	0298	0598	0898	1198	3298	3598	3898	4198	390000	K	
CKR24BX394M_	0299	0599	0899	1199	3299	3599	3899	4199	390000	M	
CKR24BX474K_	0300	0600	0900	1200	3300	3600	3900	4200	470000	K	
CKR24BX474M_	0301	0601	0901	1201	3301	3601	3901	4201	470000	M	
CKR24BX564K_	0302	0602	0902	1202	3302	3602	3902	4202	560000	K	
CKR24BX564M_	0303	0603	0903	1203	3303	3603	3903	4203	560000	M	
CKR24BX684K_	0304	0604	0904	1204	3304	3604	3904	4204	680000	K	
CKR24BX684M_	0305	0605	0905	1205	3305	3605	3905	4205	680000	M	
CKR24BX824K_	0306	0606	0906	1206	3306	3606	3906	4206	820000	K	
CKR24BX824M_	0307	0607	0907	1207	3307	3607	3907	4207	820000	M	
CKR24BX105K_	0308	0608	0908	1208	3308	3608	3908	4208	1000000	K	
CKR24BX105M_	0309	0609	0909	1209	3309	3609	3909	4209	1000000	M	
Style CKR24, Characteristic BR (Voltage-temperature limits of ±15% and +15%, -40%)											
CKR24BR124K_	0240	0540	0840	1140	3240	3540	3840	4140	120000	K	100
CKR24BR124M_	0310	0610	0910	1210	3310	3610	3910	4210	120000	M	100
CKR24BR154K_	0241	0541	0841	1141	3241	3541	3841	4141	150000	K	100
CKR24BR154M_	0242	0542	0842	1142	3242	3542	3842	4142	150000	M	100
CKR24BR184K_	0243	0543	0843	1143	3243	3543	3843	4143	180000	K	50
CKR24BR184M_	0311	0611	0911	1211	3311	3611	3911	4211	180000	M	50
CKR24BR224K_	0244	0544	0844	1144	3244	3544	3844	4144	220000	K	50
CKR24BR224M_	0245	0545	0845	1145	3245	3545	3845	4145	220000	M	50
CKR24BR274K_	0246	0546	0846	1146	3246	3546	3846	4146	270000	K	50
CKR24BR274M_	0312	0612	0912	1212	3312	3612	3912	4212	270000	M	50
CKR24BR334K_	0247	0547	0847	1147	3247	3547	3847	4147	330000	K	50
CKR24BR334M_	0248	0548	0848	1148	3248	3548	3848	4148	330000	M	50
CKR24BR394K_	0249	0549	0849	1149	3249	3549	3849	4149	390000	K	50
CKR24BR394M_	0313	0613	0913	1213	3313	3613	3913	4213	390000	M	50
CKR24BR474K_	0250	0550	0850	1150	3250	3550	3850	4150	470000	K	50
CKR24BR474M_	0251	0551	0851	1151	3251	3551	3851	4151	470000	M	50
CKR24BR564K_	0252	0552	0852	1152	3252	3552	3852	4152	560000	K	50
CKR24BR564M_	0253	0553	0853	1153	3253	3553	3853	4153	560000	M	50
CKR24BR684K_	0254	0554	0854	1154	3254	3554	3854	4154	680000	K	50
CKR24BR684M_	0255	0555	0855	1155	3255	3555	3855	4155	680000	M	50
CKR24BR824K_	0256	0556	0856	1156	3256	3556	3856	4156	820000	K	50
CKR24BR824M_	0257	0557	0857	1157	3257	3557	3857	4157	820000	M	50

_____ Add appropriate failure rate level letter (M, P, R or S)

MARKING

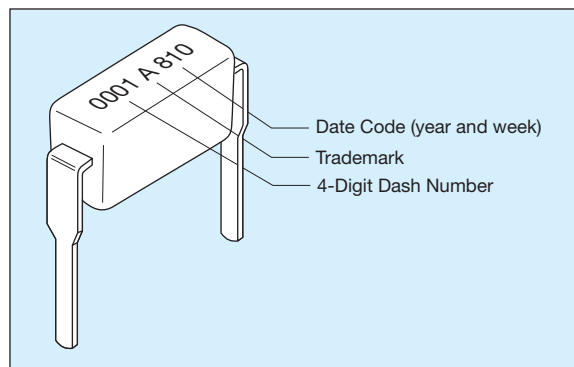

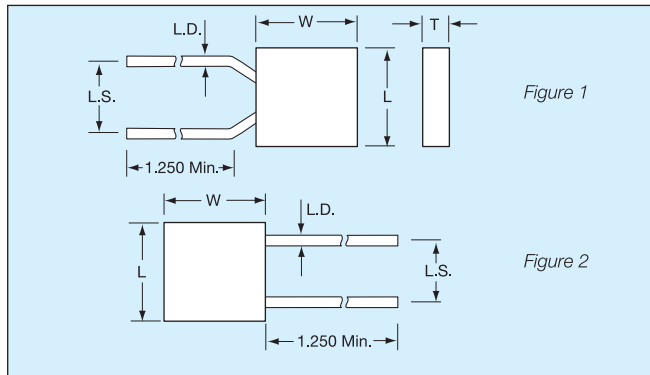

HOW TO ORDER

Military Type Designation: Styles CK05, CK06

For values, tolerances, voltages, sizes, configurations and dielectrics not shown, contact KYOCERA AVX facilities directly for information.

CK05

Style

CK = General purpose, ceramic dielectric, fixed capacitors
05 = Remaining two numbers identify shape and dimension

BX

Voltage-

Temperature Limits
First letter identifies temperature range.
B = -55°C to +125°C
Second letter identifies voltage-temperature coefficient.

104

Capacitance

First two digits are the significant figures of capacitance. Third digit indicates the additional number of zeros. For example, order 100,000 pF as 104.

K

Capacitance Tolerance

K = ±10%
M = ±20%

Not RoHS Compliant

Capacitance Change with Reference to 25°C		
Second Letter	No Voltage	Rated Voltage
X	+15, -15%	+15, -25%

PACKAGING

CK05 1000 per bag

CK06 1000 per bag

Radial tape and reel packaging available upon request (2500 pcs./reel).

SIZE SPECIFICATIONS

Dimensions: Millimeters (Inches)

Case Size	Per MIL Spec	
	CK05 (Fig. 1)	CK06 (Fig. 2)
Length (L)	4.83±.25 (.190±.010)	7.37±.25 (.290±.010)
Width (W)	4.83±.25 (.190±.010)	7.37±.25 (.290±.010)
Thickness (T)	2.29±.25 (.090±.010)	2.29±.25 (.090±.010)
Lead Spacing (L.S.)	5.08±.38 (.200±.015)	5.08±.38 (.200±.015)
Lead Diameter (L.D.)	.64±.05 (.025±.002)	.64±.05 (.025±.002)

MILITARY PART NUMBER IDENTIFICATION CK05 AND CK06

Military Type Designation	Capacitance (pF)	Capacitance Tolerance	WVDC
CK05 (BX)			
CK05BX100_	10	K, M	200
CK05BX120K_	12	K	200
CK05BX150	15	K, M	200
CK05BX180K_	18	K	200
CK05BX220	22	K, M	200
CK05BX270K_	27	K	200
CK05BX330	33	K, M	200
CK05BX390K_	39	K	200
CK05BX470	47	K, M	200
CK05BX560K_	56	K	200
CK05BX680	68	K, M	200
CK05BX820K_	82	K	200
CK05BX101_	100	K, M	200
CK05BX121K_	120	K	200
CK05BX151	150	K, M	200
CK05BX181K_	180	K	200
CK05BX221	220	K, M	200
CK05BX271K_	270	K	200
CK05BX331	330	K, M	200
CK05BX391K	390	K	200
CK05BX471_	470	K, M	200
CK05BX561K_	560	K	200
CK05BX681	680	K, M	200
CK05BX821K_	820	K	200
CK05BX102	1,000	K, M	200
CK05BX122_	1,200	K	100
CK05BX152_	1,500	K, M	100
CK05BX182K_	1,800	K	100
CK05BX222	2,200	K, M	100
CK05BX272K_	2,700	K	100
CK05BX332	3,300	K, M	100
CK05BX392K_	3,900	K	100
CK05BX472	4,700	K, M	100
CK05BX562K_	5,600	K	100
CK05BX682_	6,800	K, M	100
CK05BX822K_	8,200	K	100
CK05BX103	10,000	K, M	100
CK05BX123K	12,000	K	50
CK05BX153	15,000	K, M	50
CK05BX183K_	18,000	K	50
CK05BX223_	22,000	K, M	50
CK05BX273K_	27,000	K	50
CK05BX333	33,000	K, M	50
CK05BX393K_	39,000	K	50
CK05BX473_	47,000	K, M	50
CK05BX563K_	56,000	K	50
CK05BX683	68,000	K, M	50
CK05BX823K_	82,000	K	50
CK05BX104_	100,000	K, M	50

— Add Capacitance Tolerance Letter K = ±10% or M = ±20%

Military Type Designation	Capacitance (pF)	Capacitance Tolerance	WVDC
CK06 (BX)			
CK06BX122K	1,200	K	200
CK06BX152	1,500	K, M	200
CK06BX182K	1,800	K	200
CK06BX222	2,200	K, M	200
CK06BX272K_	2,700	K	200
CK06BX332	3,300	K, M	200
CK06BX392K	3,900	K	200
CK06BX472	4,700	K, M	200
CK06BX562K	5,600	K	200
CK06BX682_	6,800	K, M	200
CK06BX822K	8,200	K	200
CK06BX103	10,000	K, M	200
CK06BX123K	12,000	K	100
CK06BX153	15,000	K, M	100
CK06BX183K_	18,000	K	100
CK06BX223	22,000	K, M	100
CK06BX273K	27,000	K	100
CK06BX333	33,000	K, M	100
CK06BX393K_	39,000	K	100
CK06BX473_	47,000	K, M	100
CK06BX563K_	56,000	K	100
CK06BX683	68,000	K, M	100
CK06BX823K	82,000	K	100
CK06BX104	100,000	K, M	100
CK06BX124K_	120,000	K	50
CK06BX154	150,000	K, M	50
CK06BX184K	180,000	K	50
CK06BX224_	220,000	K, M	50
CK06BX274K_	270,000	K	50
CK06BX334_	330,000	K, M	50
CK06BX394K_	390,000	K	50
CK06BX474_	470,000	K, M	50
CK06BX564K_	560,000	K	50
CK06BX684	680,000	K, M	50
CK06BX824K_	820,000	K	50
CK06BX105	1.0 mfd	K, M	50

— Add Capacitance Tolerance Letter K = ±10% or M = ±20%

MARKING

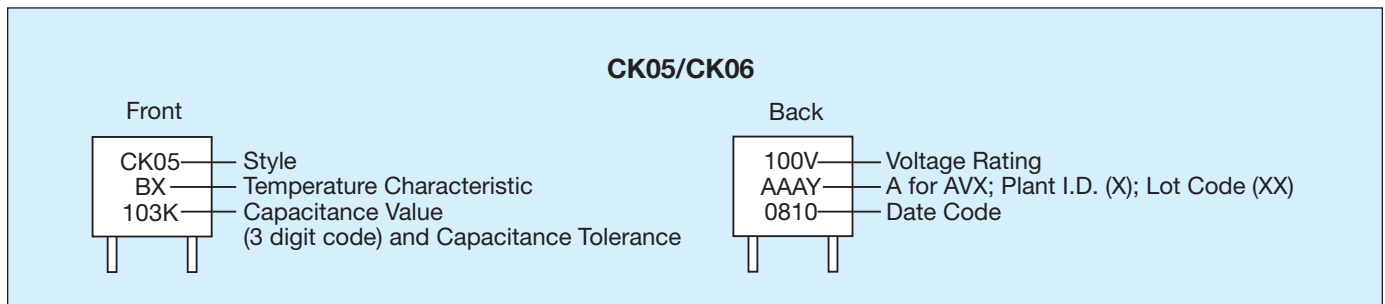

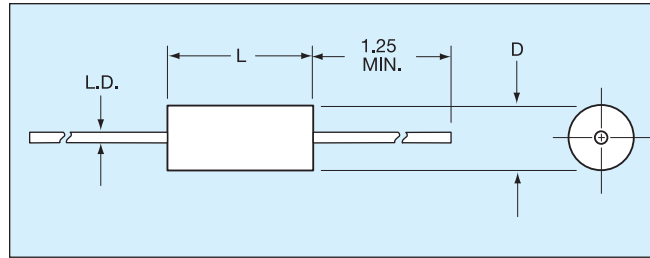

HOW TO ORDER

Military Type Designation: Styles CK12, CK13, CK14, CK15, CK16

CK12

Style

CK = General purpose, ceramic dielectric, fixed capacitors
12 = Remaining two numbers identify shape and dimension

BX

Voltage-

Temperature Limits
First letter identifies temperature range.
B = -55°C to +125°C
Second letter identifies voltage-temperature coefficient.

103

Capacitance

First two digits are the significant figures of capacitance. Third digit indicates the additional number of zeros. For example, order 10,000 pF as 103.

K

Capacitance

Tolerance
K = ±10%
M = ±20%

Not RoHS Compliant

Capacitance Change with Reference to 25°C		
Second Letter	No Voltage	Rated Voltage
R	+15, -15%	+15, -40%
X	+15, -15%	+15, -25%

PACKAGING REQUIREMENTS

Packaging: Bulk

CK12, 13 & 14 100 pcs per bag
CK15 & 16 50 pcs per bag

Tape & Reel

CK12, 13 5000 pcs per reel
CK14 3000 pcs per reel
CK15 950 pcs per reel
CK16 650 pcs per reel

SIZE SPECIFICATIONS

Dimensions: Millimeters (Inches)

Case Size	Per MIL Spec				
	CK12	CK13	CK14	CK15	CK16
Length (L)	4.07±.25 (.160±.010)	6.35±.25 (.250±.010)	9.91±.25 (.390±.010)	12.7±.51 (.500±.020)	17.53±.51 (.690±.020)
Diameter (D)	2.29±.25 (.090±.010)	2.29±.25 (.090±.010)	3.56±.25 (.140±.010)	6.35±.38 (.250±.015)	8.89±.51 (.350±.020)
Lead Diameter (L.D.)	.48±.05 (.019±.002)	.48±.05 (.019±.002)	.63±.05 (.025±.002)	.63±.05 (.025±.002)	.63±.05 (.025±.002)

MILITARY PART NUMBER IDENTIFICATION CK12 THRU CK16

Military Type Designation	Capacitance (pF)	Capacitance Tolerance	WVDC
CK12 (BX)			
CK12BX100_	10	K, M	100
CK12BX120K	12	K	100
CK12BX150	15	K, M	100
CK12BX180K	18	K	100
CK12BX220_	22	K, M	100
CK12BX270K	27	K	100
CK12BX330	33	K, M	100
CK12BX390K	39	K	100
CK12BX470_	47	K, M	100
CK12BX560K	56	K	100
CK12BX680_	68	K, M	100
CK12BX820K	82	K	100
CK12BX101_	100	K, M	100
CK12BX121K	120	K	100
CK12BX151_	150	K, M	100
CK12BX181K	180	K	100
CK12BX221_	220	K, M	100
CK12BX271K	270	K	100
CK12BX331_	330	K, M	100
CK12BX391K	390	K	100
CK12BX471_	470	K, M	100
CK12BX561K	560	K	100
CK12BX681_	680	K, M	100
CK12BX821K	820	K	100
CK12BX102_	1,000	K, M	100
CK12BX122K	1,200	K	100
CK12BX152_	1,500	K, M	100
CK12BX182K	1,800	K	100
CK12BX222_	2,200	K, M	100
CK12BX272K	2,700	K	100
CK12BX332_	3,300	K, M	100
CK12BX392K	3,900	K	100
CK12BX472_	4,700	K, M	100
CK12BX562K	5,600	K	50
CK12BX682_	6,800	K, M	50
CK12BX822K	8,200	K	50
CK12BX103_	10,000	K, M	50
CK13 (BX)			
CK13BX562K	5,600	K	100
CK13BX682_	6,800	K, M	100
CK13BX822K	8,200	K	100
CK13BX103_	10,000	K, M	100
CK13BX123K	12,000	K	50
CK13BX153_	15,000	K, M	50
CK13BX183K	18,000	K	50
CK13BX223_	22,000	K, M	50
CK13 (BR)			
CK13BR273K	27,000	K	50
CK13BR333_	33,000	K, M	50
CK13BR393K	39,000	K	50
CK13BR473_	47,000	K, M	50

— Add Capacitance Tolerance Letter K = ±10% or M = ±20%

Military Type Designation	Capacitance (pF)	Capacitance Tolerance	WVDC
CK14 (BX)			
CK14BX123K	12,000	K	100
CK14BX153_	15,000	K, M	100
CK14BX183K	18,000	K	100
CK14BX223_	22,000	K, M	100
CK14BX273K	27,000	K	100
CK14BX333_	33,000	K, M	100
CK14BX393K	39,000	K	100
CK14BX473_	47,000	K, M	100
CK14 (BR)			
CK14BR563K	56,000	K	100
CK14BR683_	68,000	K, M	100
CK14BR823K	82,000	K	100
CK14BR104_	100,000	K, M	100
CK14BR124K	120,000	K	50
CK14BR154_	150,000	K, M	50
CK14BR184K	180,000	K	50
CK14BR224_	220,000	K, M	50
CK14BR274K	270,000	K	50
CK15 (BX)			
CK15BX104K	100,000	K, M	100
CK15 (BR)			
CK15BR124K	120,000	K	100
CK15BR154_	150,000	K, M	100
CK15BR184K	180,000	K	100
CK15BR224_	220,000	K, M	100
CK15BR274K	270,000	K	100
CK15BR334_	330,000	K, M	100
CK15BR474K	470,000	K, M	50
CK15BR105_	1,000,000	K, M	50
CK16 (BR)			
CK16BR474K	470,000	K, M	100
CK16BR105_	1,000,000	K, M	100
CK16BR225_	2,200,000	K, M	50
CK16BR335_	3,300,000	K, M	50

— Add Capacitance Tolerance Letter K = ±10% or M = ±20%

MARKING

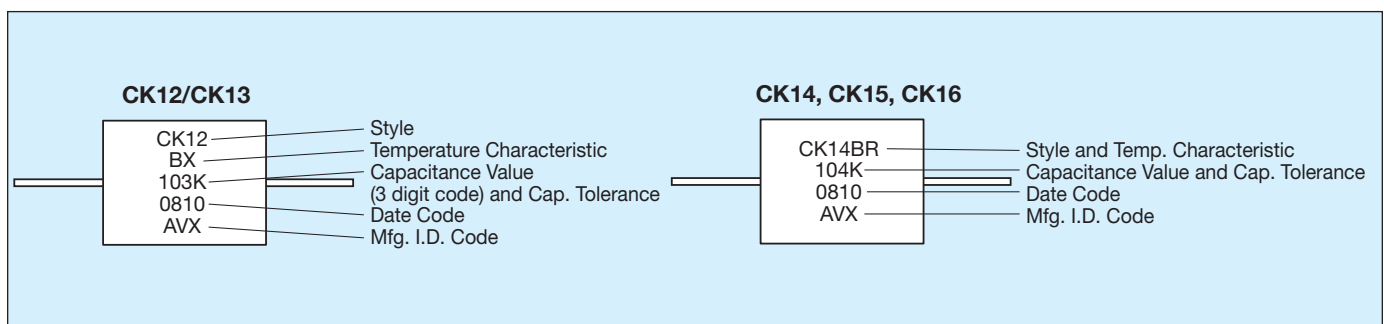

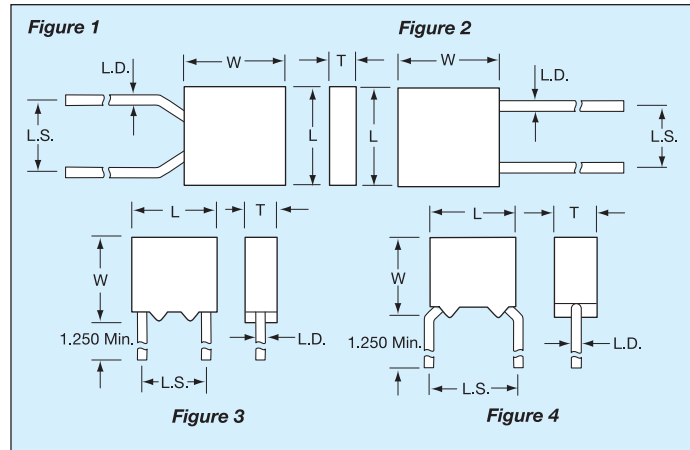

HOW TO ORDER

Military Type Designation:

Established Reliability = CCR05, CCR06, CCR07, CCR08, CCR09

Non-Established Reliability = CC05, CC06, CC07, CC08, CC09

CCR06

Style

CC = Identifies temperature compensating, ceramic dielectric, fixed capacitors.
R = Identifies Established Reliability parts
06 = Numbers identify shape and dimension

CG

Temperature Characteristic

Permissible capacitance change from capacitance at +25°C in ppm/°C		
Characteristic	Temp.	
CX	1/	+125°C
	1/	-55°C 2/
CK	±250 ppm/°C	+125°C
	+246.25, -326.25	-55°C 2/
CJ	±120 ppm/°C	+125°C
	+116.25, -166.25	-55°C 2/
CH	±60 ppm/°C	+125°C
	+55.00, -91.25	-55°C 2/
CG	±30 ppm/°C	+125°C
	+27.50, -53.75	-55°C 2/

1/ Not practically measurable.

2/ The ppm/°C values for -55°C were calculated by dividing ppm by negative 80°C.

183

Capacitance

First two digits are the significant figures of capacitance. Third digit indicates the additional number of zeros. For example, order 18,000 pF as 183. (For values below 10pF use "R" in place of decimal point, e.g., 1R4 = 1.4pF)

J

Capacitance Tolerance

C = ±0.25pF
D = ±0.5pF
F = ±1%
G = ±2%
J = ±5%
K = ±10%

R

Military Failure Rate

M = 1% per 1000 hours
P = 0.1% per 1000 hours
R = 0.01% per 1000 hours
S = 0.001% per 1000 hours

(V)

Standoff Option

To order standoff option, place "V" at the end of the part number.
Example:
CCR05CG332FSV

Not RoHS Compliant

PACKAGING REQUIREMENTS

Packaging: CCR0X: 100 pcs/bag; CC0X: 1000 pcs/bag

SIZE SPECIFICATIONS

Dimensions: Millimeters (Inches)

Per MIL Spec	Case Size				
	Length (L)	Width (W)	Thickness (T)	Lead Spacing (L.S.)	Lead Diameter (L.D.)
CCR05/CC05 Figures 1, 4	4.83±.25 (.190±.010)	4.83±.25 (.190±.010)	2.29±.25 (.090±.010)	5.08±.38 (.200±.015)	.64±.05 (.025±.002)
CCR06/CC06 Figures 2, 3	7.37±.25 (.290±.010)	7.37±.25 (.290±.010)	2.29±.25 (.090±.010)	5.08±.38 (.200±.015)	.64±.05 (.025±.002)
CCR07/CC07 Figure 2	12.19±.51 (.480±.020)	12.19±.51 (.480±.020)	3.56±.25 (.140±.010)	10.16±.51 (.400±.020)	.64±.05 (.025±.002)
CCR08/CC08 Figure 2	12.19±.51 (.480±.020)	12.19±.51 (.480±.020)	6.1±.25 (.240±.010)	10.16±.51 (.400±.020)	.64±.05 (.025±.002)
CCR09/CC09 Figure 2	4.83±.25 (.190±.010)	4.83±.25 (.190±.010)	2.29±.25 (.090±.010)	5.08±.38 (.200±.015)	.64±.05 (.025±.002)

MILITARY PART NUMBER IDENTIFICATION

Military Type Designation	Capacitance (pF)	Capacitance Tolerance	WVDC
CC05-CCR05, CC09-CCR09			
CCR05CX1R0_	1.0	B, C	200
CCR05CX1R1_	1.1	B, C	200
CCR05CX1R2_	1.2	B, C	200
CCR05CX1R3_	1.3	B, C	200
CCR05CX1R5_	1.5	B, C	200
CCR05CX1R6_	1.6	B, C	200
CCR05CX1R8_	1.8	B, C	200
CCR05CX2R0_	2.0	B, C	200
CCR05CK2R2_	2.2	B, C	200
CCR05CK2R4_	2.4	B, C	200
CCR05CK2R7_	2.7	B, C, D	200
CCR05CK3R0_	3.0	B, C, D	200
CCR05CK3R3_	3.3	B, C, D	200
CCR05CK3R6_	3.6	B, C, D	200
CCR05CK3R9_	3.9	B, C, D	200
CCR05CJ4R3_	4.3	B, C, D	200
CCR05CJ4R7_	4.7	B, C, D	200
CCR05CJ5R1_	5.1	B, C, D	200
CCR05CJ5R6_	5.6	B, C, D	200
CCR05CJ6R2_	6.2	B, C, D	200
CCR05CJ6R8_	6.8	B, C, D	200
CCR05CJ7R5_	7.5	B, C, D	200
CCR05CH8R2_	8.2	B, C, D	200
CCR05CH9R1_	9.1	B, C, D	200
CCR05CH100_	10	F, G, J	200
CCR05CH110_	11	F, G, J	200
CCR05CH120_	12	F, G, J	200
CCR05CH130_	13	F, G, J	200
CCR05CH150_	15	F, G, J	200
CCR05CH160_	16	F, G, J	200
CCR05CH180_	18	F, G, J	200
CCR05CG200_	20	F, G, J	200
CCR05CG220_	22	F, G, J	200
CCR05CG240_	24	F, G, J	200
CCR05CG270_	27	F, G, J	200
CCR05CG300_	30	F, G, J	200
CCR05CG330_	33	F, G, J	200
CCR05CG360_	36	F, G, J	200
CCR05CG390_	39	F, G, J	200
CCR05CG430_	43	F, G, J	200
CCR05CG470_	47	F, G, J	200
CCR05CG510_	51	F, G, J	200
CCR05CG560_	56	F, G, J	200
CCR05CG620_	62	F, G, J	200
CCR05CG680_	68	F, G, J	200
CCR05CG750_	75	F, G, J	200
CCR05CG820_	82	F, G, J	200
CCR05CG910_	91	F, G, J	200
CCR05CG101_	100	F, G, J	200
CCR05CG111_	110	F, G, J	200
CCR05CG121_	120	F, G, J	200
CCR05CG131_	130	F, G, J	200
CCR05CG151_	150	F, G, J	200
CCR05CG161_	160	F, G, J	200
CCR05CG181_	180	F, G, J	200
CCR05CG201_	200	F, G, J	200
CCR05CG221_	220	F, G, J	200
CCR05CG241_	240	F, G, J	200
CCR05CG271_	270	F, G, J	200
CCR05CG301_	300	F, G, J	200
CCR05CG331_	330	F, G, J	200
CCR05CG361_	360	F, G, J	100
CCR05CG391_	390	F, G, J	100
CCR05CG431_	430	F, G, J	100
CCR05CG471_	470	F, G, J	100
CCR05CG511_	510	F, G, J	100
CCR05CG561_	560	F, G, J	100
CCR05CG621_	620	F, G, J	100
CCR05CG681_	680	F, G, J	100
CCR05CG751_	750	F, G, J	100
CCR05CG821_	820	F, G, J	100
CCR05CG911_	910	F, G, J	100
CCR05CG102_	1,000	F, G, J	100
CCR05CG112_	1,100	F, G, J	100
CCR05CG122_	1,200	F, G, J	100
CCR05CG132_	1,300	F, G, J	100
CCR05CG152_	1,500	F, G, J	100
CCR05CG162_	1,600	F, G, J	100
CCR05CG182_	1,800	F, G, J	100
CCR05CG202_	2,000	F, G, J	50

Military Type Designation	Capacitance (pF)	Capacitance Tolerance	WVDC
CC05-CCR05, CC09-CCR09 (cont)			
CCR05CG222_	2,200	F, G, J	50
CCR05CG242_	2,400	F, G, J	50
CCR05CG272_	2,700	F, G, J	50
CCR05CG302_	3,000	F, G, J	50
CCR05CG332_	3,300	F, G, J	50
CC06, CCR06			
CCR06CG361_	360	F, G, J	200
CCR06CG391_	390	F, G, J	200
CCR06CG431_	430	F, G, J	200
CCR06CG471_	470	F, G, J	200
CCR06CG511_	510	F, G, J	200
CCR06CG561_	560	F, G, J	200
CCR06CG621_	620	F, G, J	200
CCR06CG681_	680	F, G, J	200
CCR06CG751_	750	F, G, J	200
CCR06CG821_	820	F, G, J	200
CCR06CG911_	910	F, G, J	200
CCR06CG102_	1,000	F, G, J	200
CCR06CG112_	1,100	F, G, J	200
CCR06CG122_	1,200	F, G, J	200
CCR06CG132_	1,300	F, G, J	200
CCR06CG152_	1,500	F, G, J	200
CCR06CG162_	1,600	F, G, J	200
CCR06CG182_	1,800	F, G, J	200
CCR06CG202_	2,000	F, G, J	100
CCR06CG222_	2,200	F, G, J	100
CCR06CG242_	2,400	F, G, J	100
CCR06CG272_	2,700	F, G, J	100
CCR06CG302_	3,000	F, G, J	100
CCR06CG332_	3,300	F, G, J	100
CCR06CG362_	3,600	F, G, J	100
CCR06CG392_	3,900	F, G, J	100
CCR06CG432_	4,300	F, G, J	100
CCR06CG472_	4,700	F, G, J	100
CCR06CG512_	5,100	F, G, J, K	50
CCR06CG562_	5,600	F, G, J, K	50
CCR06CG622_	6,200	F, G, J, K	50
CCR06CG682_	6,800	F, G, J, K	50
CCR06CG752_	7,500	F, G, J, K	50
CCR06CG822_	8,200	F, G, J, K	50
CCR06CG912_	9,100	F, G, J, K	50
CCR06CG103_	10,000	F, G, J, K	50
CCR06CG123_	12,000	F, G, J, K	50
CCR06CG153_	15,000	F, G, J, K	50
CCR06CG183_	18,000	F, G, J, K	50
CC07, CCR07			
CCR07CG222_	2,200	F, G, J, K	200
CCR07CG272_	2,700	F, G, J, K	200
CCR07CG332_	3,300	F, G, J, K	200
CCR07CG392_	3,900	F, G, J, K	200
CCR07CG472_	4,700	F, G, J, K	200
CCR07CG562_	5,600	F, G, J, K	100
CCR07CG682_	6,800	F, G, J, K	100
CCR07CG822_	8,200	F, G, J, K	100
CCR07CG103_	10,000	F, G, J, K	100
CCR07CG123_	12,000	F, G, J, K	100
CCR07CG153_	15,000	F, G, J, K	50
CCR07CG183_	18,000	F, G, J, K	50
CCR07CG223_	22,000	F, G, J, K	50
CCR07CG273_	27,000	F, G, J, K	50
CCR07CG333_	33,000	F, G, J, K	50
CCR07CG393_	39,000	F, G, J, K	50
CCR07CG473_	47,000	F, G, J, K	50
CCR07CG563_	56,000	F, G, J, K	50
CCR07CG683_	68,000	F, G, J, K	50
CCR07CG823_	82,000	F, G, J, K	50
CCR07CG104_	100,000	F, G, J, K	50
CC08, CCR08			
CCR08CG392_	3,900	G, J, K	200
CCR08CG472_	4,700	G, J, K	200
CCR08CG153_	15,000	G, J, K	100
CCR08CG183_	18,000	G, J, K	100
CCR08CG563_	56,000	G, J, K	50
CCR08CG683_	68,000	G, J, K	50

— Add appropriate failure rate level (M, P, R or S)
— Add appropriate cap. tolerance letter

— Add appropriate failure rate level (M, P, R or S)
— Add appropriate cap. tolerance letter

Note: For marking information, see page 73.

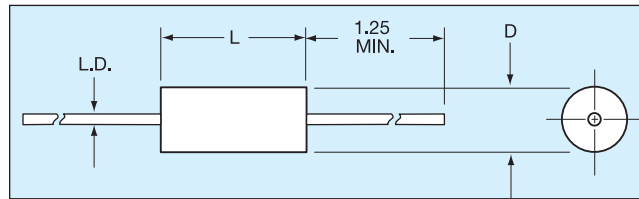

HOW TO ORDER

Military Type Designation:

Established Reliability = CCR75, CCR76, CCR77, CCR78, CCR79

Non-Established Reliability = CC75, CC76, CC77, CC78, CC79

CCR76

Style

CC = Identifies temperature compensating, ceramic dielectric, fixed capacitors.
R = Identifies Established Reliability parts
76 = Numbers identify shape and dimension

CG

Temperature Characteristic

Permissible capacitance change from capacitance at +25°C in ppm/°C		
Characteristic	Temp.	
CX	1/	+125°C
	1/	-55°C 2/
CK	±250 ppm/°C	+125°C
	+246.25, -326.25	-55°C 2/
CJ	±120 ppm/°C	+125°C
	+116.25, -166.25	-55°C 2/
CH	±60 ppm/°C	+125°C
	+55.00, -91.25	-55°C 2/
CG	±30 ppm/°C	+125°C
	+27.50, -53.75	-55°C 2/

1/ Not practically measurable.

2/ The ppm/°C values for -55°C were calculated by dividing ppm by negative 80°C.

102

Capacitance

First two digits are the significant figures of capacitance. Third digit indicates the additional number of zeros. For example, order 1,000 pF as 102. (For values below 10pF use "R" in place of decimal point, e.g., 1R8 = 1.8pF.)

K

Capacitance Tolerance

C = ±0.25pF
D = ±0.5pF
F = ±1%
G = ±2%
J = ±5%
K = ±10%

R

Military Failure Rate

M = 1% per 1000 hours
P = 0.1% per 1000 hours
R = 0.01% per 1000 hours
S = 0.001% per 1000 hours

Not RoHS Compliant

PACKAGING REQUIREMENTS

Packaging:

Bulk

CCR75/CC75, CCR76/CC76, CCR77/CC77, 100 pcs/bag
CCR78/CC78, CCR79/CC79 50 pcs/bag

Tape & Reel

CCR75/CC75, CCR76/CC76 5000 pcs/reel
CCR77/CC77 3000 pcs/reel
CCR78/CC78 950 pcs/reel
CCR79/CC79 650 pcs/reel

SIZE SPECIFICATIONS

Dimensions: Millimeters (Inches)

Per MIL Spec	Case Size		
	Length (L)	Diameter (D)	Lead Diameter (L.D.)
MIL-PRF-20			
CCR75 CC75	4.07±.25 (.160±.010)	2.29±.25 (.090±.010)	.48±.05 (.019±.002)
CCR76 CC76	6.35±.25 (.250±.010)	2.29±.25 (.090±.010)	.48±.05 (.019±.002)
CCR77 CC77	9.91±.25 (.390±.010)	3.56±.25 (.140±.010)	.63±.05 (.025±.002)
CCR78 CC78	12.7±.51 (.500±.020)	6.35±.38 (.250±.015)	.63±.05 (.025±.002)
CCR79 CC79	17.53±.51 (.690±.020)	8.89±.51 (.350±.020)	.63±.05 (.025±.002)

**MILITARY PART NUMBER IDENTIFICATION CC75 THRU CC79 AND
CCR75 THRU CCR79**

Military Type Designation	Capacitance (pF)	Capacitance Tolerance	WVDC
CC75-CCR75			
CCR75CX1R0_	1.0	C	200
CCR75CX1R1_	1.1	C	200
CCR75CX1R2_	1.2	C	200
CCR75CX1R3_	1.3	C	200
CCR75CX1R5_	1.5	C	200
CCR75CX1R6_	1.6	C	200
CCR75CX1R8_	1.8	C	200
CCR75CX2R0_	2.0	C	200
CCR75CK2R2_	2.2	C	200
CCR75CK2R4_	2.4	C	200
CCR75CK2R7_	2.7	C, D	200
CCR75CK3R0_	3.0	C, D	200
CCR75CK3R3_	3.3	C, D	200
CCR75CK3R6_	3.6	C, D	200
CCR75CK3R9_	3.9	C, D	200
CCR75CJ4R3_	4.3	C, D	200
CCR75CJ4R7_	4.7	C, D	200
CCR75CJ5R1_	5.1	C, D	200
CCR75CJ5R6_	5.6	C, D	200
CCR75CJ6R2_	6.2	C, D	200
CCR75CJ6R8_	6.8	C, D	200
CCR75CJ7R5_	7.5	C, D	200
CCR75CH8R2_	8.2	C, D	200
CCR75CH9R1_	9.1	C, D	200
CCR75CH100_	10	G, J	200
CCR75CH110_	11	G, J	200
CCR75CH120_	12	G, J	200
CCR75CH130_	13	G, J	200
CCR75CH150_	15	G, J	200
CCR75CH160_	16	G, J	200
CCR75CH180_	18	G, J	200
CCR75CG200_	20	F, G, J	200
CCR75CG220_	22	F, G, J	200
CCR75CG240_	24	F, G, J	200
CCR75CG270_	27	F, G, J	200
CCR75CG300_	30	F, G, J	200

— Add appropriate failure rate level (M, P, R or S)
— Add appropriate cap. tolerance letter

Military Type Designation	Capacitance (pF)	Capacitance Tolerance	WVDC
CCR75-CCR75			
CCR75CG330_	33	F, G, J	200
CCR75CG360_	36	F, G, J	200
CCR75CG390_	39	F, G, J	200
CCR75CG430_	43	F, G, J	200
CCR75CG470_	47	F, G, J	200
CCR75CG510_	51	F, G, J	200
CCR75CG560_	56	F, G, J	200
CCR75CG620_	62	F, G, J	200
CCR75CG680_	68	F, G, J	200
CCR75CG750_	75	F, G, J	200
CCR75CG820_	82	F, G, J	100
CCR75CG910_	91	F, G, J	100
CCR75CG101_	100	F, G, J	100
CCR75CG111_	110	F, G, J	100
CCR75CG121_	120	F, G, J	100
CCR75CG131_	130	F, G, J	100
CCR75CG151_	150	F, G, J	100
CCR75CG161_	160	F, G, J	100
CCR75CG181_	180	F, G, J	100
CCR75CG201_	200	F, G, J	100
CCR75CG221_	220	F, G, J	100
CCR75CG241_	240	F, G, J	100
CCR75CG271_	270	F, G, J	50
CCR75CG301_	300	F, G, J	50
CCR75CG331_	330	F, G, J	50
CCR75CG361_	360	F, G, J	50
CCR75CG391_	390	F, G, J	50
CCR75CG431_	430	F, G, J	50
CCR75CG471_	470	F, G, J	50
CCR75CG511_	510	F, G, J	50
CCR75CG561_	560	F, G, J	50
CCR75CG621_	620	F, G, J	50
CCR75CG681_	680	F, G, J	50

— Add appropriate failure rate level (M, P, R or S)
— Add appropriate cap. tolerance letter

Note: For marking information, see page 73.

**MILITARY PART NUMBER IDENTIFICATION CC75 THRU CC79 AND
CCR75 THRU CCR79**

Military Type Designation	Capacitance (pF)	Capacitance Tolerance	WVDC
CC76, CCR76			
CCR76CG820_	82	F, G, J	200
CCR76CG910_	91	F, G, J	200
CCR76CG101_	100	F, G, J	200
CCR76CG111_	110	F, G, J	200
CCR76CG121_	120	F, G, J	200
CCR76CG131_	130	F, G, J	200
CCR76CG271_	270	F, G, J	100
CCR76CG301_	300	F, G, J	100
CCR76CG331_	330	F, G, J	100
CCR76CG361_	360	F, G, J	100
CCR76CG391_	390	F, G, J	100
CCR76CG431_	430	F, G, J	100
CCR76CG471_	470	F, G, J	100
CCR76CG511_	510	F, G, J	100
CCR76CG561_	560	F, G, J	100
CCR76CG621_	620	F, G, J	100
CCR76CG681_	680	F, G, J	100
CCR76CG751_	750	F, G, J	50
CCR76CG821_	820	F, G, J	50
CCR76CG911_	910	F, G, J	50
CCR76CG102_	1,000	F, G, J	50
CC77, CCR77			
CCR77CG151_	150	F, G, J	200
CCR77CG161_	160	F, G, J	200
CCR77CG181_	180	F, G, J	200
CCR77CG201_	200	F, G, J	200
CCR77CG221_	220	F, G, J	200
CCR77CG241_	240	F, G, J	200
CCR77CG271_	270	F, G, J	200
CCR77CG301_	300	F, G, J	200
CCR77CG331_	330	F, G, J	200
CCR77CG361_	360	F, G, J	200
CCR77CG391_	390	F, G, J	200
CCR77CG431_	430	F, G, J	200
CCR77CG471_	470	F, G, J	200
CCR77CG511_	510	F, G, J	200
CCR77CG561_	560	F, G, J	200
CCR77CG621_	620	F, G, J	200
CCR77CG681_	680	F, G, J	200
CCR77CG751_	750	F, G, J	100
CCR77CG821_	820	F, G, J	100
CCR77CG911_	910	F, G, J	100
CCR77CG102_	1,000	F, G, J	100
CCR77CG112_	1,100	F, G, J	100
CCR77CG122_	1,200	F, G, J	100
CCR77CG132_	1,300	F, G, J	100
CCR77CG152_	1,500	F, G, J	100
CCR77CG162_	1,600	F, G, J	100
CCR77CG182_	1,800	F, G, J	100
CCR77CG202_	2,000	F, G, J	100
CCR77CG222_	2,200	F, G, J	100
CCR77CG242_	2,400	F, G, J	50
CCR77CG272_	2,700	F, G, J	50

— Add appropriate failure rate level (M, P, R or S)
— Add appropriate cap. tolerance letter

Military Type Designation	Capacitance (pF)	Capacitance Tolerance	WVDC
CC77, CCR77 (cont)			
CCR77CG302_	3,000	F, G, J	50
CCR77CG332_	3,300	F, G, J	50
CCR77CG362_	3,600	F, G, J	50
CCR77CG392_	3,900	F, G, J	50
CCR77CG432_	4,300	F, G, J	50
CCR77CG472_	4,700	F, G, J	50
CCR77CG512_	5,100	F, G, J, K	50
CCR77CG562_	5,600	F, G, J, K	50
CC78, CCR78			
CCR78CG821_	820	F, G, J, K	200
CCR78CG102_	1,000	F, G, J, K	200
CCR78CG122_	1,200	F, G, J, K	200
CCR78CG152_	1,500	F, G, J, K	200
CCR78CG182_	1,800	F, G, J, K	200
CCR78CG222_	2,200	F, G, J, K	200
CCR78CG272_	2,700	F, G, J, K	200
CCR78CG332_	3,300	F, G, J, K	200
CCR78CG392_	3,900	F, G, J, K	100
CCR78CG472_	4,700	F, G, J, K	100
CCR78CG562_	5,600	F, G, J, K	100
CCR78CG682_	6,800	F, G, J, K	100
CCR78CG822_	8,200	F, G, J, K	100
CCR78CG103_	10,000	F, G, J, K	100
CCR78CG123_	12,000	F, G, J, K	100
CCR78CG153_	15,000	F, G, J, K	50
CCR78CG183_	18,000	F, G, J, K	50
CCR78CG223_	22,000	F, G, J, K	50
CCR78CG273_	27,000	F, G, J, K	50
CC79, CCR79			
CCR79CG392_	3,900	F, G, J, K	200
CCR79CG472_	4,700	F, G, J, K	200
CCR79CG562_	5,600	F, G, J, K	200
CCR79CG682_	6,800	F, G, J, K	200
CCR79CG822_	8,200	F, G, J, K	200
CCR79CG103_	10,000	F, G, J, K	200
CCR79CG153_	15,000	F, G, J, K	100
CCR79CG183_	18,000	F, G, J, K	100
CCR79CG223_	22,000	F, G, J, K	100
CCR79CG273_	27,000	F, G, J, K	100
CCR79CG333_	33,000	F, G, J, K	100
CCR79CG393_	39,000	F, G, J, K	100
CCR79CG473_	47,000	F, G, J, K	50
CCR79CG563_	56,000	F, G, J, K	50
CCR79CG683_	68,000	F, G, J, K	50
CCR79CG823_	82,000	F, G, J, K	50

— Add appropriate failure rate level (M, P, R or S)
— Add appropriate cap. tolerance letter

Note: Complete type designation will include the appropriate capacitance tolerance in the 11th digit. For CC styles, delete 3rd and 12th digits.

Note: For marking information, see page 73.

MARKING

Radials

CC05 & CC09

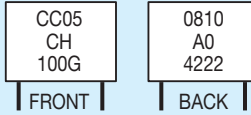

Date Code
A=Lot Letter
0=1st Digit of AVX FSCM #
4222=Last four digits of AVX FSCM #

CCR05 & CCR09

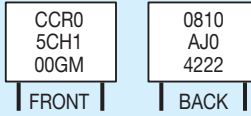

Date Code
A=Lot Letter
J="J" or "JAN" Brand
0=1st Digit of AVX FSCM #
4222=Last four digits of AVX FSCM #

CC06

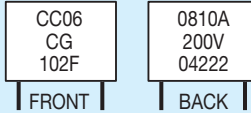

Date Code & Lot Letter
200V=Rated Voltage
04222=AVX FSCM #

CCR06

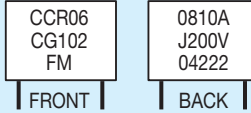

Date Code & Lot Letter
J="J" or "JAN" Brand
200V=Rated Voltage
04222=AVX FSCM #

CC07

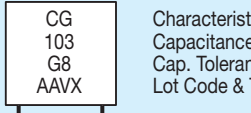

Characteristic
Capacitance Value
Cap. Tolerance & Year Code (8 for 2008)
Lot Code & Trademark

CCR07

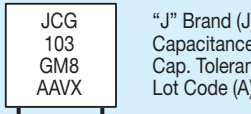

"J" Brand (J) and Characteristic (CG)
Capacitance Value
Cap. Tolerance (G) FR Level (M), & Year Code (8 for 2008)
Lot Code (A); and Trademark (AVX)

CC08

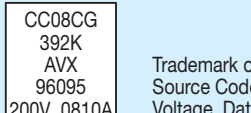

Trademark or Manufacturer's Name
Source Code (FSCM)
Voltage, Date Code and Lot Symbol

CCR08

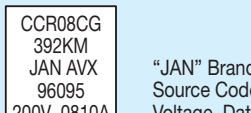

"JAN" Brand & Trademark or Manufacturer's Name
Source Code (FSCM)
Voltage, Date Code and Lot Symbol

Axials

CC75, CC76

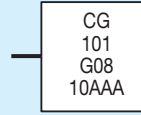

Characteristic
Capacitance Value
Cap. Tolerance & 2 digit Year Code
2 digit Week, 2 digit Lot Code, A for AVX

CCR75, CCR76

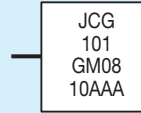

"J" Brand (J) and Characteristic (CG)
Capacitance Value
Cap. Tolerance (G) FR Level (M), & 2 digit Year Code
2 digit Week, A for AVX

CC77

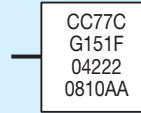

Type Designation
FSCM
4 digit Date Code, 2 digit Lot Code

CCR77



Type Designation
"J" Brand and FSCM
4 digit Date Code, 2 digit Lot Code

CC78, CC79

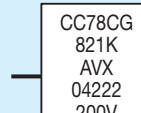

Type Designation
Trademark or Manufacturer's Name
Source Code (FSCM)
Voltage
4 digit Date Code

CCR78, CCR79

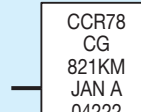

Type Designation
TC
Capacitance Tolerance, Failure Rate
"JAN" Brand, A for AVX
FSCM
Voltage
4 digit Date Code, 2 digit Lot Code

HOW TO ORDER

Military Type Designation: Capacitors, Fixed, Ceramic Dielectric,
(Temperature Stable and General Purpose), High Reliability

M123	A	01	BX	B	103	K	C
Mil-Spec Number	Modification Spec.	Slash Sheet Number	Temperature Characteristic	Voltage B = 50 C = 100	Capacitance Code	Capacitance Tolerance C = ±0.25pF D = ±0.5pF F = ±1% J = ±5% K = ±10%	Termination C = Copper, solder coated (type C-4 or C-5 of MIL-STD-1276) W = Copper clad steel, solder coated, 60 micro inches minimum.

Capacitance change with reference to 25°C over temperature range -55°C to +125°C		
Symbol	Without Voltage	With Rated DC Voltage
BP	0 ± 30 ppm/°C	0 ± 30 ppm/°C
BX	±15, -15%	±15, -25%

Not RoHS Compliant

CROSS REFERENCE MIL-SPEC TEST REQUIREMENTS

TEST DESCRIPTION	MIL-PRF-123	MIL-PRF-39014	MIL-PRF-20	MIL-PRF-55681
NDT (Non-Destructive Test)	100% Ultrasonic Scan or Neutron-Radiography	No	No	No
Pre-Cap Visual (Pre-Encapsulation Visual Examination)	100%	No	No	No
D.P.A. (Destructive Physical Analysis)	Lot by Lot—Pre-Termination Lot by Lot—Finished Product	No	No	No
Pre-Cap Terminal Strength (Pre-Encapsulation Pull Test)	Lot by Lot	No	No	No
Life Test (Lot by Lot)	Lot by Lot—1000 Hours	No	No	No
Low Voltage Humidity (Lot by Lot)	Lot by Lot	No	No	No
Thermal Shock 100 Cycles (Lot by Lot)	Lot by Lot	No	No	No

MIL-PRF-123/STYLE CKS05, -/01

Part Number 1/	Capacitance pF	Capacitance Tolerance	Voltage-Temperature Limits	Rated Voltage			
M123A01BPC4R7_C	4.7	C, D	BP	100			
M123A01BPC5R1_C	5.1						
M123A01BPC5R6_C	5.6						
M123A01BPC6R2_C	6.2						
M123A01BPC6R8_C	6.8						
M123A01BPC7R5_C	7.5						
M123A01BPC8R2_C	8.2						
M123A01BPC9R1_C	9.1						
M123A01BPC100_C	10						
M123A01BPC110_C	11						
M123A01BPC120_C	12	C, D C, J, K	BP	100			
M123A01BPC130_C	13						
M123A01BPC150_C	15						
M123A01BPC160_C	16						
M123A01BPC180_C	18						
M123A01BP_200_C	20				C, J, K C, J, K C, J, K F, J, K	BP	100, 200
M123A01BP_220_C	22						
M123A01BP_240_C	24						
M123A01BP_270_C	27						
M123A01BP_300_C	30						
M123A01BP_330_C	33						
M123A01BP_360_C	36						
M123A01BP_390_C	39						
M123A01BP_430_C	43						
M123A01BP_470_C	47						
M123A01BP_510C	51	F, J, K	BP	100, 200			
M123A01BP_560_C	56						
M123A01BP_620_C	62						
M123A01BP_680_C	68						
M123A01BP_750_C	75						
M123A01BP_820_C	82						
M123A01BP_910_C	91						
M123A01BP_101_C	100						
M123A01BP_111_C	110						
M123A01BP_121_C	120						
M123A01BP_131_C	130	F, J, K	BP	100, 200			
M123A01BP_151_C	150						
M123A01BP_161_C	160						
M123A01BP_181_C	180						
M123A01BP_201_C	200						
M123A01BP_221_C	220						
M123A01BP_241_C	240						
M123A01BP_271_C	270				F, J, K	BP	50,100,200
M123A01BP_301_C	300						
M123A01BP_331_C	330						
M123A01BP_361_C	360	F, J, K	BP	50,100			
M123A01BP_391_C	390						
M123A01BP_431_C	430						
M123A01BP_471_C	470						
M123A01BP_511_C	510						
M123A01BP_561_C	560						
M123A01BP_621_C	620						
M123A01BP_681_C	680						
M123A01BP_751_C	750						
M123A01BP_821_C	820						
M123A01BP_911_C	910	F, J, K	BP	50,100			
M123A01BP_102_C	1,000						
M123A01BP_112_C	1,100						
M123A01BP_122_C	1,200						
M123A01BP_132_C	1,300						
M123A01BP_152_C	1,500						
M123A01BP_162_C	1,600						
M123A01BP_182_C	1,800						
M123A01BPB202_C	2,000				F, J, K	BP	50
M123A01BPB222_C	2,200						
M123A01BPB242_C	2,400						
M123A01BPB272_C	2,700						
M123A01BPB302_C	3,000						
M123A01BPB332_C	3,300	F, J, K	BP	50			
M123A01BXC271KC	270				K	BX	100
M123A01BXC331KC	330						
M123A01BXC391KC	390						
M123A01BXC471KC	470						
M123A01BXC561KC	560						
M123A01BXC681KC	680						
M123A01BXC821KC	820						
M123A01BXC102KC	1,000						
M123A01BXC122KC	1,200						
M123A01BXC152KC	1,500						
M123A01BXC182KC	1,800	K	BX	50			
M123A01BXC222KC	2,200						
M123A01BXC272KC	2,700						
M123A01BXC332KC	3,300						
M123A01BXC392KC	3,900						
M123A01BXC472KC	4,700						
M123A01BXC562KC	5,600				K	BX	50
M123A01BXC682KC	6,800						
M123A01BXC822KC	8,200						
M123A01BXC103KC	10,000						
M123A01BXC123KC	12,000						
M123A01BXC153KC	15,000						
M123A01BXC183KC	18,000						
M123A01BXC223KC	22,000						
M123A01BXC273KC	27,000						
M123A01BXC333KC	33,000						
M123A01BXC393KC	39,000	K	BX	50, 100			
M123A01BXC473KC	47,000						
M123A02BX_563KC	56,000						
M123A02BX_683KC	68,000						
M123A02BX_823KC	82,000	K	BX	50, 100			
M123A02BX_104KC	100,000						

CKS05

CKS06

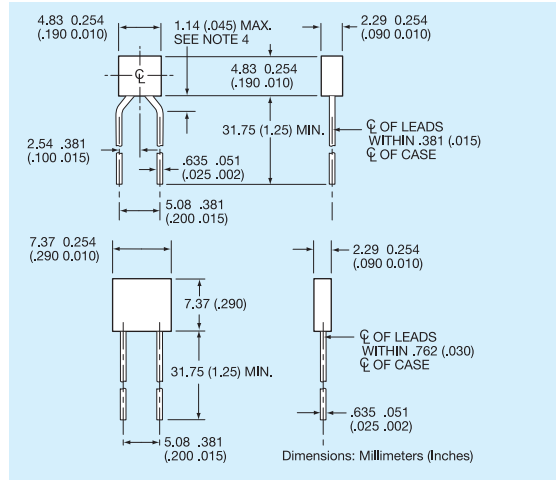

MIL-PRF-123/STYLE CKS06, -/02

Part Number 1/	Capacitance pF	Capacitance Tolerance	Voltage-Temperature Limits	Rated Voltage			
M123A02BPC271_C	270	F, J, K	BP	100			
M123A02BPC301_C	300						
M123A02BPC331_C	330						
M123A02BP_361_C	360	F, J, K	BP	100, 200			
M123A02BP_391_C	390						
M123A02BP_431_C	430						
M123A02BP_471_C	470						
M123A02BP_511_C	510						
M123A02BP_561_C	560						
M123A02BP_621_C	620						
M123A02BP_681_C	680						
M123A02BP_751_C	750						
M123A02BP_821_C	820						
M123A02BP_911_C	910	F, J, K	BP	100, 200			
M123A02BP_102_C	1,000						
M123A02BP_112C	1,100						
M123A02BP_122_C	1,200						
M123A02BP_132_C	1,300						
M123A02BP_152_C	1,500						
M123A02BP_162_C	1,600						
M123A02BP_182_C	1,800						
M123A02BPC202_C	2,000				F, J, K	BP	100
M123A02BPC222_C	2,200						
M123A02BPC242_C	2,400						
M123A02BP_272_C	2,700	F, J, K	BP	50, 100			
M123A02BP_302_C	3,000						
M123A02BP_332_C	3,300						
M123A02BP_362_C	3,600						
M123A02BP_392_C	3,900						
M123A02BP_432_C	4,300						
M123A02BP_472_C	4,700						
M123A02BPB512_C	5,100				F, J, K	BP	50
M123A02BPB562_C	5,600						
M123A02BPB622_C	6,200						
M123A02BPB682_C	6,800						
M123A02BPB752_C	7,500						
M123A02BPB822_C	8,200	F, J, K	BP	50			
M123A02BPB912_C	9,100						
M123A02BPB103_C	10,000						
M123A02BPB123_C	12,000						
M123A02BPB153_C	15,000						
M123A02BPB183_C	18,000						
M123A02BXC562KC	5,600				K	BX	100
M123A02BXC682KC	6,800						
M123A02BXC822KC	8,200						
M123A02BXC103KC	10,000						
M123A02BXC123KC	12,000						
M123A02BXC153KC	15,000						
M123A02BXC183KC	18,000						
M123A02BXC223KC	22,000						
M123A02BXC273KC	27,000						
M123A02BXC333KC	33,000						
M123A02BXC393KC	39,000	K	BX	100			
M123A02BXC473KC	47,000						
M123A02BX_563KC	56,000						
M123A02BX_683KC	68,000						
M123A02BX_823KC	82,000	K	BX	50, 100			
M123A02BX_104KC	100,000						

MILITARY MIL-PRF-123



Axial Leads

MIL-PRF-123/STYLE CKS06, -/02 (CONTINUED)

Part Number 1/	Capacitance pF	Capacitance Tolerance	Voltage-Temperature Limits	Rated Voltage
M123A02BxB124KC	120,000	K	BX	50
M123A02BxB154KC	150,000			
M123A02BxB184KC	180,000			
M123A02BxB224KC	220,000			
M123A02BxB274KC	270,000			
M123A02BxB334KC	330,000			
M123A02BxB394KC	390,000			
M123A02BxB474KC	470,000			
M123A02BxB564KC	560,000			
M123A02BxB684KC	680,000			
M123A02BxB824KC	820,000	K	BX	50
M123A02BxB105KC	1,000,000			

Dimensions: Millimeters (Inches)

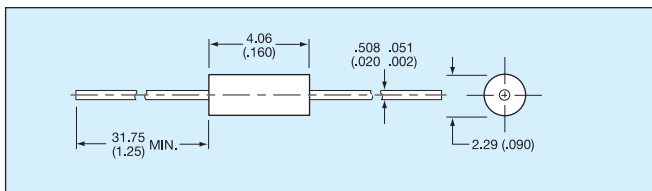

MIL-PRF-123/STYLE CKS11, -/04

Part Number 1/	Capacitance pF	Capacitance Tolerance	Voltage-Temperature Limits	Rated Voltage
M123A04BPC4R7-W	4.7	C,D	BP	100
M123A04BPC5R1-W	5.1	C,D	BP	100
M123A04BPC6R2-W	6.2	C,D	BP	100
M123A04BPC6R8-W	6.8	C,D	BP	100
M123A04BPC7R5-W	7.5	C,D	BP	100
M123A04BPC8R2-W	8.2	C,D	BP	100
M123A04BPC9R1-W	9.1	C,D	BP	100
M123A04BPC100-W	10	C,J, K	BP	100
M123A04BPC110-W	11	C,J, K	BP	100
M123A04BPC120-W	12	C,J, K	BP	100
M123A04BPC130-W	13	C,J, K	BP	100
M123A04BPC150-W	15	C,J, K	BP	100
M123A04BPC160-W	16	C,J, K	BP	100
M123A04BPC180-W	18	C,J, K	BP	100
M123A04BPC200-W	20	C,J, K	BP	100
M123A04BPC220-W	22	C,J, K	BP	100
M123A04BPC240-W	24	C,J, K	BP	100
M123A04BPC270-W	27	F, J, K	BP	100
M123A04BPC300-W	30	F, J, K	BP	100
M123A04BPC330-W	33	F, J, K	BP	100
M123A04BPC360-W	36	F, J, K	BP	100
M123A04BPC390-W	39	F, J, K	BP	100
M123A04BPC430-W	43	F, J, K	BP	100
M123A04BPC470-W	47	F, J, K	BP	100
M123A04BPC510-W	51	F, J, K	BP	100
M123A04BPC560-W	56	F, J, K	BP	100
M123A04BPC620-W	62	F, J, K	BP	100
M123A04BPC680-W	68	F, J, K	BP	100
M123A04BPC750-W	75	F, J, K	BP	100
M123A04BPC820-W	82	F, J, K	BP	100
M123A04BPC910-W	91	F, J, K	BP	100
M123A04BPC101-W	100	F, J, K	BP	100

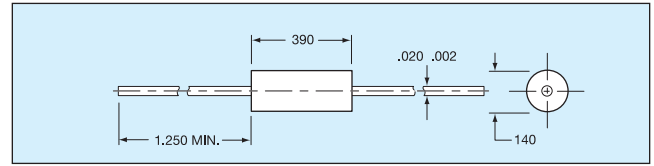
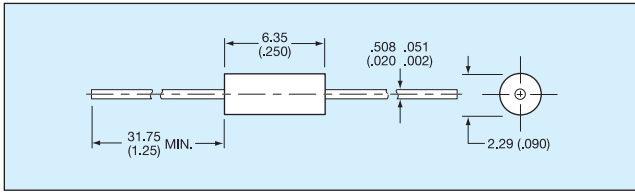

MIL-PRF-123/STYLE CKS12, -/05

Part Number 1/	Capacitance pF	Capacitance Tolerance	Voltage-Temperature Limits	Rated Voltage
M123A05BPD820_W	82	F, J, K	BP	200
M123A05BPD910_W	91	F, J, K	BP	200
M123A05BPD101_W	100	F, J, K	BP	200
M123A05BP_111_W	110	F, J, K	BP	100, 200
M123A05BP_121_W	120	F, J, K	BP	100, 200
M123A05BP_131_W	130	F, J, K	BP	100, 200
M123A05BPC151_W	150	F, J, K	BP	100
M123A05BPC161_W	160	↓	↓	↓
M123A05BPC181_W	180	↓	↓	↓
M123A05BPC201_W	200	↓	↓	↓
M123A05BPC221_W	220	F, J, K	BP	100
M123A05BPB241_W	240	F, J, K	BP	50
M123A05BP_271_W	270	F, J, K	BP	50, 100
M123A05BP_301_W	300	↓	↓	↓
M123A05BP_331_W	330	↓	↓	↓
M123A05BP_361_W	360	↓	↓	↓
M123A05BP_391_W	390	↓	↓	↓
M123A05BP_431_W	430	↓	↓	↓
M123A05BP_471_W	470	F, J, K	BP	50, 100
M123A05BPC511_W	510	F, J, K	BP	100
M123A05BPC561_W	560	↓	↓	↓
M123A05BPC621_W	620	↓	↓	↓
M123A05BPC681_W	680	F, J, K	BP	100
M123A05BPB751_W	750	F, J, K	BP	50
M123A05BPB821_W	820	↓	↓	↓
M123A05BPB911_W	910	↓	↓	↓
M123A05BPB102_W	1000	F, J, K	BP	50
M123A05BXC122KW	1,200	↓	↓	↓
M123A05BXC152KW	1,500	↓	↓	↓
M123A05BXC182KW	1,800	↓	↓	↓
M123A05BXC222KW	2,200	↓	↓	↓
M123A05BXC272KW	2,700	↓	↓	↓
M123A05BXC332KW	3,300	↓	↓	↓
M123A05BXC392KW	3,900	↓	↓	↓
M123A05BXC472KW	4,700	K	BX	100
M123A05BXC562KW	5,600	↓	↓	↓
M123A05BXC682KW	6,800	↓	↓	↓
M123A05BXC822KW	8,200	↓	↓	↓
M123A05BXC103KW	10,000	K	BX	50

MIL-PRF-123/STYLE CKS14, -/06

Part Number 1/	Capacitance pF	Capacitance Tolerance	Voltage-Temperature Limits	Rated Voltage
M123A06BPD151_W	150	F, J, K	BP	200
M123A06BPD161_W	160	↓	↓	↓
M123A06BPD181_W	180	↓	↓	↓
M123A06BPD201_W	200	F, J, K	BP	200
M123A06BPD221_W	220	↓	↓	↓
M123A06BP_241_W	240	F, J, K	BP	100, 200
M123A06BP_271_W	270	↓	↓	↓
M123A06BP_301_W	300	↓	↓	↓
M123A06BP_331_W	330	↓	↓	↓
M123A06BP_361_W	360	↓	↓	↓
M123A06BP_391_W	390	↓	↓	↓
M123A06BP_431_W	430	↓	↓	↓
M123A06BP_471_W	470	↓	↓	↓
M123A06BP_511_W	510	↓	↓	↓
M123A06BP_561_W	560	↓	↓	↓
M123A06BP_621_W	620	↓	↓	↓
M123A06BP_681_W	680	F, J, K	BP	100, 200
M123A06BPC751_W	750	F, J, K	BP	100
M123A06BPC821_W	820	↓	↓	↓
M123A06BPC911_W	910	↓	↓	↓
M123A06BPC102_W	1,000	F, J, K	BP	100
M123A06BP_112_W	1,100	F, J, K	BP	50, 100
M123A06BP_122_W	1,200	↓	↓	↓
M123A06BP_132_W	1,300	↓	↓	↓
M123A06BP_152_W	1,500	↓	↓	↓
M123A06BP_162_W	1,600	↓	↓	↓
M123A06BP_182_W	1,800	↓	↓	↓
M123A06BP_202_W	2,000	↓	↓	↓
M123A06BP_222_W	2,200	F, J, K	BP	50, 100
M123A06BPB242_W	2,400	F, J, K	BP	50
M123A06BPB272_W	2,700	↓	↓	↓
M123A06BPB302_W	3,000	↓	↓	↓
M123A06BPB332_W	3,300	↓	↓	↓
M123A06BPB362_W	3,600	↓	↓	↓
M123A06BPB392_W	3,900	↓	↓	↓
M123A06BPB432_W	4,300	↓	↓	↓
M123A06BPB472_W	4,700	↓	↓	↓
M123A06BPB512_W	5,100	↓	↓	↓
M123A06BPB562_W	5,600	↓	↓	↓
M123A06BPB622_W	6,200	↓	↓	↓
M123A06BPB682_W	6,800	F, J, K	BP	50
M123A06BXC562KW	5,600	↓	↓	↓
M123A06BXC682KW	6,800	↓	↓	↓
M123A06BXC822KW	8,200	↓	↓	↓
M123A06BXC103KW	10,000	K	BX	100
M123A06BXC123KW	12,000	↓	↓	↓
M123A06BXC153KW	15,000	↓	↓	↓
M123A06BXC183KW	18,000	↓	↓	↓
M123A06BXC223KW	22,000	↓	↓	↓
M123A06BXC273KW	27,000	↓	↓	↓
M123A06BXC333KW	33,000	↓	↓	↓
M123A06BXC393KW	39,000	↓	↓	↓
M123A06BXC473KW	47,000	K	BX	50

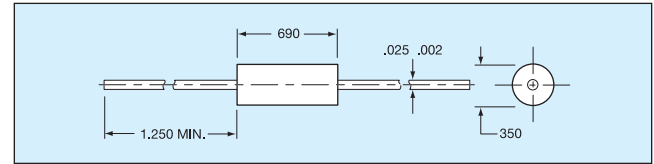
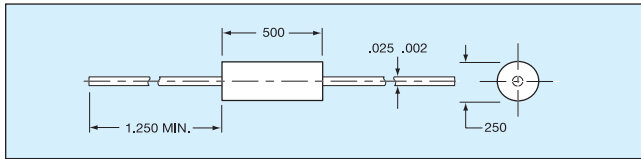

MIL-PRF-123/STYLE CKS15, -/07

Part Number 1/	Capacitance pF	Capacitance Tolerance	Voltage-Temperature Limits	Rated Voltage
M123A07BPD821_W M123A07BPD102_W	820 1000	F, J, K F, J, K	BP BP	200 200
M123A07BP_112_W M123A07BP_122_W M123A07BP_132_W M123A07BP_152_W M123A07BP_162_W M123A07BP_182_W M123A07BP_202_W M123A07BP_222_W	1,100 1,200 1,300 1,500 1,600 1,800 2,000 2,200	F, J, K ↓ ↓ ↓ ↓ ↓ ↓ ↓ ↓	BP ↓ ↓ ↓ ↓ ↓ ↓ ↓	100, 200 ↓ ↓ ↓ ↓ ↓ ↓ ↓ ↓
M123A07BP_242_W M123A07BP_272_W M123A07BP_302_W M123A07BP_332_W	2,400 2,700 3,000 3,300	F, J, K ↓ ↓ ↓	BP ↓ ↓ ↓	50, 200 ↓ ↓ ↓
M123A07BPB362_W	3,600	F, J, K	BP	50
M123A07BP_392_W M123A07BP_432_W M123A07BP_472_W M123A07BP_512_W M123A07BP_562_W M123A07BP_622_W M123A07BP_682_W M123A07BP_752_W M123A07BP_822_W M123A07BP_912_W	3,900 4,300 4,700 5,100 5,600 6,200 6,800 7,500 8,200 9,100	F, J, K ↓ ↓ ↓ ↓ ↓ ↓ ↓ ↓ ↓ ↓	BP ↓ ↓ ↓ ↓ ↓ ↓ ↓ ↓ ↓ ↓	50, 100 ↓ ↓ ↓ ↓ ↓ ↓ ↓ ↓ ↓ ↓
M123A07BP_103_W M123A07BP_113_W M123A07BP_123_W	10,000 11,000 12,000	↓ ↓ ↓	↓ ↓ ↓	↓ ↓ ↓
M123A07BPB133_W M123A07BPB153_W M123A07BPB163_W M123A07BPB183_W M123A07BPB203_W M123A07BPB223_W M123A07BPB273_W	13,000 15,000 16,000 18,000 20,000 22,000 27,000	F, J, K ↓ ↓ ↓ ↓ ↓ ↓	BP ↓ ↓ ↓ ↓ ↓ ↓	50 ↓ ↓ ↓ ↓ ↓ ↓
M123A07BXC123KW M123A07BXC153KW M123A07BXC183KW M123A07BXC223KW M123A07BXC273KW M123A07BXC333KW M123A07BXC393KW M123A07BXC473KW M123A07BXC563KW M123A07BXC683KW M123A07BXC823KW M123A07BXC104KW	12,000 15,000 18,000 22,000 27,000 33,000 39,000 47,000 56,000 68,000 82,000 100,000	↓ ↓ ↓ ↓ ↓ ↓ ↓ ↓ ↓ ↓ ↓ ↓	↓ ↓ ↓ ↓ ↓ ↓ ↓ ↓ ↓ ↓ ↓ ↓	100 ↓ ↓ ↓ ↓ ↓ ↓ ↓ ↓ ↓ ↓ ↓
M123A07BXC124KW M123A07BXC154KW M123A07BXC184KW M123A07BXC224KW M123A07BXC274KW M123A07BXC334KW M123A07BXC394KW M123A07BXC474KW	120,000 150,000 180,000 220,000 270,000 330,000 390,000 470,000	↓ ↓ ↓ ↓ ↓ ↓ ↓ ↓	↓ ↓ ↓ ↓ ↓ ↓ ↓ ↓	100 ↓ ↓ ↓ ↓ ↓ ↓ ↓
M123A07BXC564KW M123A07BXC684KW M123A07BXC824KW M123A07BXC105KW	560,000 680,000 820,000 1,000,000	↓ ↓ ↓ ↓	↓ ↓ ↓ ↓	50 ↓ ↓ ↓

MIL-PRF-123/STYLE CKS16, -/08

Part Number 1/	Capacitance pF	Capacitance Tolerance	Voltage-Temperature Limits	Rated Voltage
M123A08BPC242_W M123A08BPC272_W M123A08BPC302_W M123A08BPC332_W M123A08BPC362_W	2,400 2,700 3,000 3,300 3,600	F, J, K ↓ ↓ ↓ ↓	BP ↓ ↓ ↓ ↓	100 ↓ ↓ ↓ ↓
M123A08BP_392_W M123A08BP_432_W M123A08BP_472_W M123A08BP_512_W M123A08BP_562_W M123A08BP_622_W M123A08BP_682_W M123A08BP_822_W M123A08BP_912_W M123A08BP_103_W	3,900 4,300 4,700 5,100 5,600 6,200 6,800 8,200 9,100 10,000	F, J, K ↓ ↓ ↓ ↓ ↓ ↓ ↓ ↓ ↓ ↓	BP ↓ ↓ ↓ ↓ ↓ ↓ ↓ ↓ ↓ ↓	100, 200 ↓ ↓ ↓ ↓ ↓ ↓ ↓ ↓ ↓ ↓
M123A08BPB113_W M123A08BPB123_W M123A08BPB133_W	11,000 12,000 13,000	F, J, K F, J, K F, J, K	BP BP BP	50 50 50
M123A08BP_153_W M123A08BP_163_W M123A08BP_183_W M123A08BP_203_W M123A08BP_223_W	15,000 16,000 18,000 20,000 22,000	F, J, K ↓ ↓ ↓ ↓	BP ↓ ↓ ↓ ↓	50, 100 ↓ ↓ ↓ ↓
M123A08BPC273_W M123A08BPC333_W M123A08BPC393_W	27,000 33,000 39,000	F, J, K F, J, K F, J, K	BP BP BP	100 100 100
M123A08BPB473_W M123A08BPB563_W M123A08BPB683_W M123A08BPB823_W	47,000 56,000 68,000 82,000	F, J, K ↓ ↓ ↓	BP ↓ ↓ ↓	50 ↓ ↓ ↓
M123A08BXC124KW M123A08BXC154KW M123A08BXC184KW M123A08BXC224KW M123A08BXC274KW M123A08BXC334KW M123A08BXC394KW M123A08BXC474KW	120,000 150,000 180,000 220,000 270,000 330,000 390,000 470,000	↓ ↓ ↓ ↓ ↓ ↓ ↓ ↓	↓ ↓ ↓ ↓ ↓ ↓ ↓ ↓	100 ↓ ↓ ↓ ↓ ↓ ↓ ↓
M123A08BXC564KW M123A08BXC684KW M123A08BXC824KW M123A08BXC105KW	560,000 680,000 820,000 1,000,000	↓ ↓ ↓ ↓	↓ ↓ ↓ ↓	50 ↓ ↓ ↓

STYLE CKS22, -/16

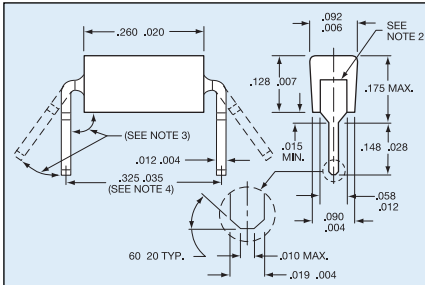

NOTES:

1. Dimensions are in inches.
2. Leads shall be centered within $\pm .005$ (0.13mm).
3. The angle shall be $95^\circ +10^\circ, -5^\circ$.
4. The distance between the centers of the mounting holes will be $.300 \pm .010$ inch (7.62 \pm 0.25mm).
5. Nonconductive material shall not extend beyond .030 inch (0.76mm) from the edge of the capacitor body.

STYLE CKS23, -/17

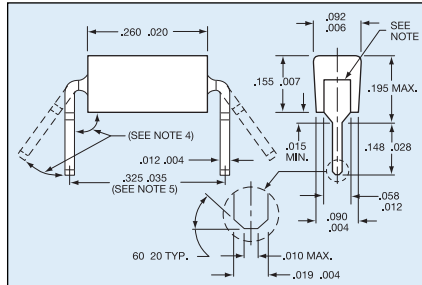

NOTES:

1. Dimensions are in inches.
2. Metric equivalents are given for general information only.
3. Leads shall be centered within $\pm .005$ (0.13mm).
4. The angle shall be $95^\circ +10^\circ, -5^\circ$.
5. The distance between the centers of the mounting holes will be $.300 \pm .010$ inch (7.62 \pm 0.25mm).
6. Nonconductive materials shall not extend beyond .030 inch (0.76mm) from the edge of the capacitor body.

STYLE CKS24, -/18

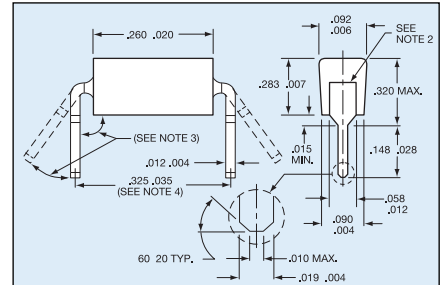

NOTES:

1. Dimensions are in inches.
2. Leads shall be centered within $\pm .005$ (0.13mm).
3. The angle shall be $95^\circ +10^\circ, -5^\circ$.
4. The distance between the centers of the mounting holes will be $.300 \pm .010$ inch (7.62 \pm 0.25mm).
5. Nonconductive material shall not extend beyond .030 inch (0.76mm) from the edge of the capacitor body.

MIL-PRF-123/STYLE CKS22, -/16

Part Number 1/	Capacitance pf	Capacitance Tolerance	Voltage-Temperature Limits	Rated Voltage
M123A16BPD1R0DC	1.0	D	BP	200
M123A16BPD1R2DC	1.2			
M123A16BPD1R5DC	1.5			
M123A16BPD1R8DC	1.8			
M123A16BPD2R2DC	2.2			
M123A16BPD2R7DC	2.7			
M123A16BPD3R3DC	3.3			
M123A16BPD3R9DC	3.9			
M123A16BPD4R7DC	4.7			
M123A16BPD5R6DC	5.6			
M123A16BPD6R8DC	6.8			
M123A16BPD8R2DC	8.2			
M123A16BPD100_C	10	D, J, K		
M123A16BPD120_C	12			
M123A16BPD150_C	15			
M123A16BPD180_C	18			
M123A16BPD220_C	22			
M123A16BPD270_C	27			
M123A16BPD330_C	33			
M123A16BPD390_C	39			
M123A16BPD470_C	47			
M123A16BPD560_C	56			
M123A16BPD680_C	68	F, J, K		
M123A16BPD820_C	82			
M123A16BPD101_C	100			
M123A16BPD121_C	120			
M123A16BPD151_C	150			
M123A16BPD181_C	180			
M123A16BPD221_C	220			
M123A16BPD271_C	270			
M123A16BPD331_C	330			
M123A16BPD391_C	390			
M123A16BPD471_C	470	F, J, K	BP	200
M123A16BPC561_C	560	F, J, K	BP	100
M123A16BPC681_C	680			
M123A16BPC821_C	820			
M123A16BPC102_C	1000			
M123A16BPC122_C	1200			
M123A16BPC152_C	1500			
M123A16BPC182_C	1800			
M123A16BPC222_C	2200	F, J, K	BP	100
M123A16BPB272_C	2700	F, J, K	BP	50
M123A16BPB332_C	3300			
M123A16BPB392_C	3900			
M123A16BPB472_C	4700	F, J, K	BP	50
M123A16BXD271KC	270	K	BX	200
M123A16BXD331_C	330	K, M		
M123A16BXD391KC	390	K		
M123A16BXD471_C	470	K, M		
M123A16BXD561KC	560	K		
M123A16BXD681_C	680	K, M		
M123A16BXD821KC	820	K	BX	200
M123A16BXC102_C	1000	K, M	BX	100
M123A16BXC122KC	1200	K		
M123A16BXC152_C	1500	K, M		
M123A16BXC182KC	1800	K		
M123A16BXC222_C	2200	K, M	BX	100

Part Number 1/	Capacitance pf	Capacitance Tolerance	Voltage-Temperature Limits	Rated Voltage
M123A16BXC272KC	2700	K	BX	100
M123A16BXC332_C	3300	K, M		
M123A16BXC392KC	3900	K		
M123A16BXC472_C	4700	K, M		
M123A16BXC562KC	5600	K		
M123A16BXC682_C	6800	K, M		
M123A16BXC822KC	8200	K		
M123A16BXC103_C	10000	K, M	BX	100
M123A16BXC123KC	12000	K		
M123A16BXC153_C	15000	K, M	BX	50
M123A16BXC183KC	18000	K		
M123A16BXC223_C	22000	K, M		
M123A16BXC273KC	27000	K		
M123A16BXC333_C	33000	K, M		
M123A16BXC393KC	39000	K		
M123A16BXC473_C	47000	K, M		
M123A16BXC563KC	56000	K		
M123A16BXC683_C	68000	K, M		
M123A16BXC823KC	82000	K		
M123A17BXC104_C	100000	K, M	BX	100
M123A16BXC823KC	82000	K		
M123A16BXC104_C	100000	K, M	BX	50

1/The complete part number shall include a symbol to indicate capacitance tolerance, as applicable.

MIL-PRF-123/STYLE CKS23, -/17

Part Number 1/	Capacitance pf	Capacitance Tolerance	Voltage-Temperature Limits	Rated Voltage
M123A17BPD561_C	560	F, J, K	BP	200
M123A17BPD681_C	680			
M123A17BPD821_C	820			
M123A17BPD102_C	1000			
M123A17BPD122_C	1200	F, J, K	BP	200
M123A17BPC272_C	2700	F, J, K	BP	100
M123A17BPC332_C	3300	F, J, K	BP	100
M123A17BPB472_C	4700	F, J, K	BP	50
M123A17BPB562_C	5600			
M123A17BPB682_C	6800			
M123A17BPB822_C	8200			
M123A17BPB103_C	10000	F, J, K	BP	50
M123A17BXD102_C	1000	K, M	BX	200
M123A17BXD122KC	1200	K		
M123A17BXD152_C	1500	K, M		
M123A17BXD182KC	1800	K		
M123A17BXD222_C	2200	K, M		
M123A17BXD272KC	2700	K		
M123A17BXD332_C	3300	K, M		
M123A17BXD392KC	3900	K		
M123A17BXD472_C	4700	K, M		
M123A17BXD562KC	5600	K		
M123A17BXD682_C	6800	K, M		
M123A17BXD822KC	8200	K		
M123A17BXD103_C	10000	K, M	BX	200
M123A17BXC123KC	12000	K	BX	100
M123A17BXC153_C	15000	K, M		
M123A17BXC183KC	18000	K		
M123A17BXC223_C	22000	K, M		
M123A17BXC273KC	27000	K	BX	100

Part Number 1/	Capacitance pf	Capacitance Tolerance	Voltage-Temperature Limits	Rated Voltage
M123A17BXC333_C	33000	K, M	BX	100
M123A17BXC393KC	39000	K		
M123A17BXC473_C	47000	K, M		
M123A17BXC563KC	56000	K		
M123A17BXC683_C	68000	K, M, K		
M123A17BXC823KC	82000			
M123A17BXC104_C	100000	K, M	BX	100
M123A17BXC124KC	120000	K	BX	50
M123A17BXC154_C	150000	K, M		
M123A17BXC184KC	180000	K		
M123A17BXC224_C	220000	K, M	BX	50

1/The complete part number shall include a symbol to indicate capacitance tolerance, as applicable.

MIL-PRF-123/STYLE CKS24, -/18

Part Number 1/	Capacitance pf	Capacitance Tolerance	Voltage-Temperature Limits	Rated Voltage
M123A18BRC124KC	120,000	K, M	BR	100
M123A18BRC154_C	150,000	K, M	BR	100
M123A18BRB184KC	180,000	K, M	BR	50
M123A18BRB224_C	220,000	K, M	BR	50
M123A18B-E274_C	270,000	K, M	BX, BR	50
M123A18B-E334_C	330,000			
M123A18B-E394_C	390,000			
M123A18B-E474_C	470,000	K, M	BX, BR	50
M123A18BXB564_C	560,000	K, M	BX	50
M123A18BXB684_C	680,000	K, M	BX	50
M123A18BXB824_C	820,000			
M123A18BXB105_C	1,000,000	K, M	BX	50

1/The complete PIN will include additional letters to indicate voltage-temperature limits and capacitance tolerance, as applicable.

MARKING

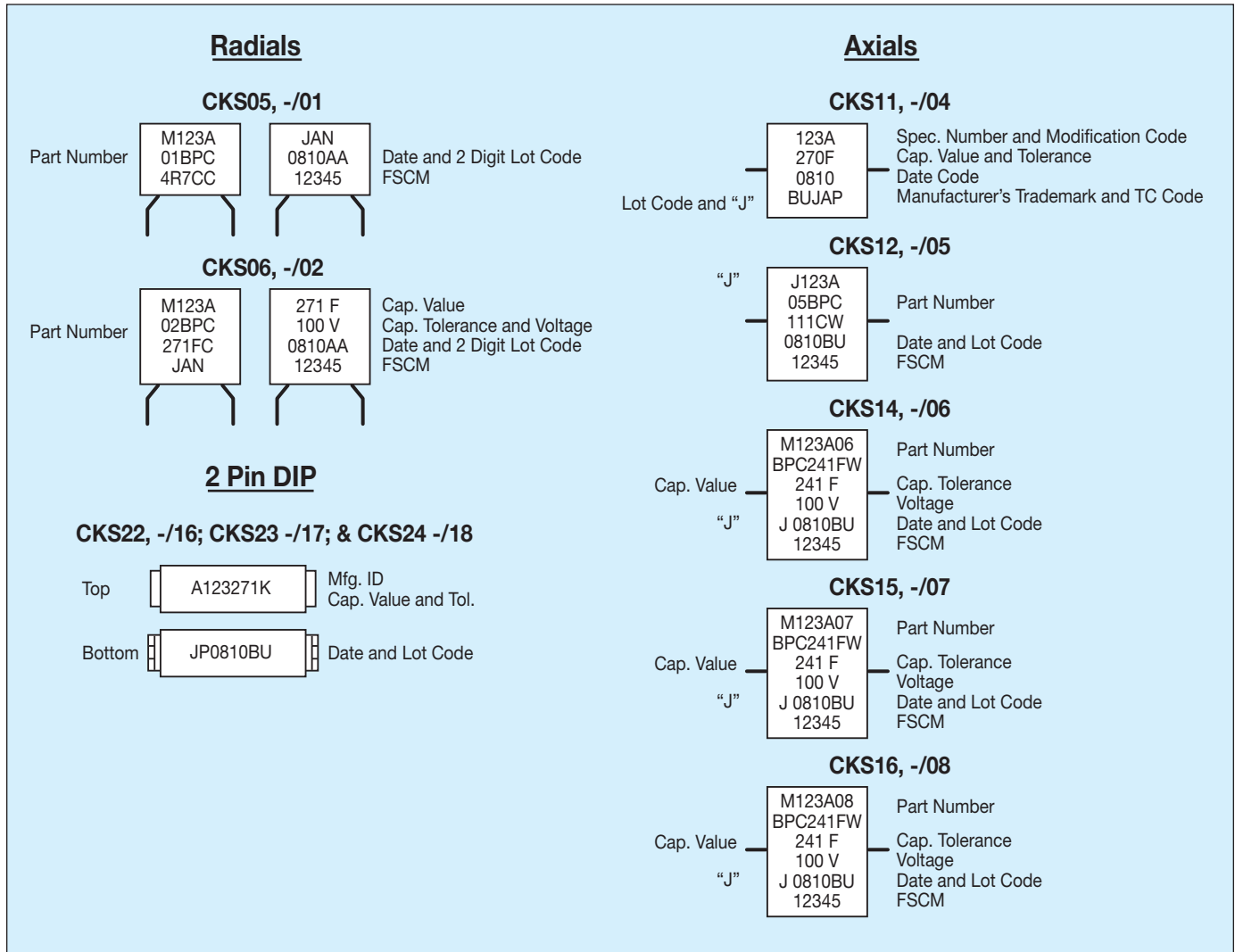

MILITARY PART NUMBER CROSS REFERENCE MIL-PRF-123/

MIL-PRF-123		MIL-PRF-39014		MIL-PRF-20		MIL-PRF-55681		CATALOG
CKS #	M123/ -	CKR #	M39014/ -	CCR #	M20/ -	CDR #	M55681/ -	
CKS05	/1	CKR05	/01	CCR05	/35	N/A	N/A	MR05
CKS06	/2	CKR06	/02	CCR06	/36	N/A	N/A	MR06
CKS11	/4	CKR11	/05	CCR75	/27	N/A	N/A	MA10
CKS12	/5	CKR12	/05	CCR76	/28	N/A	N/A	MA20
CKS14	/6	CKR14	/05	CCR77	/29	N/A	N/A	MA40
CKS15	/7	CKR15	/05	CCR78	/30	N/A	N/A	MA50
CKS16	/8	CKR16	/05	CCR79	/31	N/A	N/A	MA60
CKS51	/10	N/A	N/A	N/A	N/A	CDR01	/1	0805
CKS52	/11	N/A	N/A	N/A	N/A	N/A	N/A	1210
CKS53	/12	N/A	N/A	N/A	N/A	CDR03	/1	1808
CKS54	/13	N/A	N/A	N/A	N/A	CDR06	/3	2225
CKS22	/16	CKR22	/22	N/A	N/A	N/A	N/A	MD01
CKS23	/17	CKR23	/22	N/A	N/A	N/A	N/A	MD02
CKS24	/18	CKR24	/22	N/A	N/A	N/A	N/A	MD03

EUROPEAN CECC

Detail Specifications - 30-601 & 30-701

Ceramic capacitors are available to European CECC specifications covering two standard dielectric materials: 1B/COG, and 2C1/X7R.

To order use KYOCERA AVX part number with the Failure Rate code of "T" for CECC.

MOLDED RADIAL – CECC

	1B/A CECC 30 601 009 Issue 1			2C1/C CECC 30 701 007 Issue 1		
	50V	100V	200V	50V	100V	200V
B/MR05	1R0-682	1R0-472	1R0-332	221-224	221-154	221-393
C/MR06	1R0-223	1R0-153	1R0-123	122-105	122-474	122-124



FOLLOW US:     

VISIT US AT WWW.KYOCERA-AVX.COM 

A light gray world map is centered in the background of the lower half of the page. It shows the outlines of continents and major landmasses.

North America

Tel: +1 864-967-2150

Europe

Tel: +44 1276-697000

Asia

Tel: +65 6286-7555

Central America

Tel: +55 11-46881960

Japan

Tel: +81 740-321250

Looking for pricing, stock, or lifecycle information?

Click below to explore more details on WIN SOURCE:

- ⊖ [View CKR06BX105KPVTR2 on WIN SOURCE](#)
- ⊖ [AVX Corp/Kyocera Corp Information](#)

Optimize Your Supply Chain with WIN SOURCE Solutions

- ✓ Global Sourcing Solution
- ✓ Obsolete Management
- ✓ Cost Control Management
- ✓ Shortage Management
- ✓ Alternative Solution
- ✓ Excess Inventory Management