



**THE DATASHEET OF
HC1210CG100K202**



Multilayer Ceramic Chip Capacitors

High Voltage Type $\geq 1KV$

HC Series

MERITEK

FEATURE

- High voltage rating in a given case size.
- High reliability and thermal stability.
- Application: DC to DC converter, High Voltage Coupling/DC blocking, Back-lighting inverters, LAN/WLAN interface, Power supplies, Snubbers in HF power convertors.



PART NUMBERING SYSTEM



HC (1) 1812 (2) XR (3) 822 (4) K (5) 102 (6)

No	Item	Digit	Description	Reference
(1)	Meritek Series	HC	High-Voltage Ceramic Chip Capacitor	High voltage application with $\geq 1KVdc$
(2)	Size	1812	1812 inch (4532 mm)	0805,1206,1210,1808, 1825,2211,2220,2225
(3)	Dielectric	XR	X7R	CG: C0G(NP0), XR: X7R, XF: X5R, YV: Y5V
(4)	Capacitance	822	822: $82 \times 10^2 pF = 8200pF$	103: $10 \times 10^3 pF$, 4R7: 4.7pF
(5)	Tolerance	K	(K): $\pm 10\%$	F: $\pm 1\%$, G: $\pm 2\%$, J: $\pm 5\%$, K: $\pm 10\%$, M: $\pm 20\%$
(6)	Rated Voltage	102	Working Voltage: 1000VDC	152: 1.5KVDC, 202: 2.0KVDC, 3KVDC, 4KVDC

DIMENSIONS

Size Inch (mm)	L (mm)	W (mm)	Thickness	M_B min (mm)
			T (mm) code	
0603 (1608)	1.60 ± 0.20	0.80 ± 0.15	See Thickness Specification Reference Table below	0.40 ± 0.15
0805 (2012)	2.10 ± 0.20	1.25 ± 0.20		0.50 ± 0.20
1206 (3216)	3.30 ± 0.30	$1.60 + 0.30 / - 0.10$		0.60 ± 0.20
1210 (3225)	3.30 ± 0.40	2.50 ± 0.30		0.75 ± 0.35
1808 (4520)	4.60 ± 0.50	2.00 ± 0.20		0.75 ± 0.35
1812 (4532)	4.60 ± 0.50	3.20 ± 0.30		0.75 ± 0.35
1825 (4563)	4.60 ± 0.50	6.30 ± 0.40		0.75 ± 0.35
2220 (5750)	5.70 ± 0.50	5.00 ± 0.40		0.85 ± 0.35
2225 (5763)	5.70 ± 0.50	6.30 ± 0.40		0.85 ± 0.35

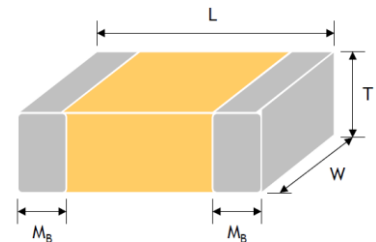

THICKNESS SPECIFICATION REFERENCE

Code	Thickness (mm)	Code	Thickness (mm)	Code	Thickness (mm)
A	0.60 ± 0.10	I	1.25 ± 0.20	Q	$0.50 + 0.02 / - 0.05$
B	$0.8 + 0.15 / - 0.10$	J	1.15 ± 0.15	R	3.10 ± 0.30
C	1.25 ± 0.10	K	0.50 ± 0.20	S	0.80 ± 0.07
D	1.40 ± 0.15	L	0.30 ± 0.03	T	0.85 ± 0.10
E	1.60 ± 0.20	M	0.95 ± 0.10	U	0.50 ± 0.10
F	2.00 ± 0.20	N	0.50 ± 0.05	V	0.20 ± 0.02
G	2.50 ± 0.30	O	3.50 ± 0.20	X	0.80 ± 0.10
H	2.80 ± 0.30	P	$1.60 + 0.3 / - 0.10$	Z	0.25 ± 0.03

Multilayer Ceramic Chip Capacitors

High Voltage Type $\geq 1KV$

HC Series

MERITEK

ELECTRICAL CHARACTERISTICS

Properties	Characteristics							
Dielectric	C0G(NP0)							
Size	0805, 1206, 1210, 1808, 1812, 1825, 2220, 2225	0603, 0805, 1206, 1210, 1808, 1812, 1825, 2220, 2225						
Rated Voltage	1KV, 1.5KV, 2KV, 3KV, 4KV							
Capacitance Range	0.5pF ~ 12nF							
Capacitance Tolerance	See Capacitance Tolerance Reference Table Below							
Dissipation Factor	<table border="1"> <thead> <tr> <th>Cap. Range</th> <th>Q Spec.</th> </tr> </thead> <tbody> <tr> <td>Cap < 30pF</td> <td>$Q \geq 400+20C$</td> </tr> <tr> <td>Cap $\geq 30pF$</td> <td>$Q \geq 1000$</td> </tr> </tbody> </table>	Cap. Range	Q Spec.	Cap < 30pF	$Q \geq 400+20C$	Cap $\geq 30pF$	$Q \geq 1000$	$\leq 2.5\%$
	Cap. Range	Q Spec.						
Cap < 30pF	$Q \geq 400+20C$							
Cap $\geq 30pF$	$Q \geq 1000$							
Measured at the condition of 30~70% related humidity.								
Cap. & D.F. Test Condition (30~70% Relative Humidity)	For 25°C at ambient temperature	* Preconditioning : Preform a heat treatment at $150 \pm 10^\circ C$ for an hour, then leave in ambient condition for 24 ± 2 hours before measurement						
	<table border="1"> <thead> <tr> <th>Cap. Range</th> <th>Test Condition</th> </tr> </thead> <tbody> <tr> <td>Cap $\leq 1000pF$</td> <td>$1.0 \pm 0.2V_{rms}$, $1.0MHz \pm 10\%$</td> </tr> <tr> <td>Cap $> 1000pF$</td> <td>$1.0 \pm 0.2V_{rms}$, $1.0KHz \pm 10\%$</td> </tr> </tbody> </table>	Cap. Range	Test Condition	Cap $\leq 1000pF$	$1.0 \pm 0.2V_{rms}$, $1.0MHz \pm 10\%$	Cap $> 1000pF$	$1.0 \pm 0.2V_{rms}$, $1.0KHz \pm 10\%$	$1.0 \pm 0.2V_{rms}$, $1.0KHz \pm 10\%$, at 25°C ambient temperature
Cap. Range	Test Condition							
Cap $\leq 1000pF$	$1.0 \pm 0.2V_{rms}$, $1.0MHz \pm 10\%$							
Cap $> 1000pF$	$1.0 \pm 0.2V_{rms}$, $1.0KHz \pm 10\%$							
Insulation Resistance	$\geq 100G\Omega$ or $R \cdot C \geq 5000\Omega \cdot F$ Whichever is smaller	$\geq 10G\Omega$ or $R \cdot C \geq 100\Omega \cdot F$ Whichever is smaller						
Operation Temperature	-55°C ~ +125°C							
Temperature Coefficient	$\pm 30ppm/^\circ C$	$\pm 15\%$						
Termination	Cu (or Ag)/Ni/Sn (lead-free)							

CAPACITANCE TOLERANCE REFERENCE

Code	Description	Code	Description	Code	Description	Code	Description
A	$\pm 0.05 pF$	F	$\pm 1 \%$	J	$\pm 5 \%$	N	-5%~10%
B	$\pm 0.10 pF$	G	$\pm 2 \%$	K	$\pm 10 \%$	P	$\pm 0.02 pF$
C	$\pm 0.25 pF$	H	$\pm 3 \%$	L	0%~10%	Q	$\pm 0.03 pF$
D	$\pm 0.50 pF$	I	-10%~0%	M	$\pm 20 \%$	Z	-20%~80%

Multilayer Ceramic Chip Capacitors

High Voltage Type $\geq 1KV$

HC Series

MERITEK

RELIABILITY TEST CONDITIONS AND REQUIREMENTS

Item	Test Condition	Requirements																										
Visual and Dimensions	---	<ul style="list-style-type: none"> * No remarkable defect. * Dimensions to confirm to individual specification sheet. 																										
Capacitance		* Shall not exceed the limits given in the detailed spec.																										
Q/ D.F. (Dissipation Factor)	Class I: C0G(NP0) Cap $\leq 1000pF$, $1.0\pm 0.2V_{rms}$, $1MHz\pm 10\%$ Cap $> 1000pF$, $1.0\pm 0.2V_{rms}$, $1KHz\pm 10\%$ Class II: (X7R) $1.0\pm 0.2V_{rms}$, $1kHz\pm 10\%$	<table border="1"> <thead> <tr> <th>Dielectric</th> <th>Rated Voltage (V)</th> <th>Q/D.F.</th> <th>Remark</th> </tr> </thead> <tbody> <tr> <td rowspan="2">Class I(NP0)</td> <td rowspan="2">All</td> <td>$Q\geq 1000$</td> <td>Cap$\geq 30pF$</td> </tr> <tr> <td>$Q\geq 400+20C$</td> <td>Cap$< 30pF$</td> </tr> <tr> <td rowspan="2">Class II(X7R)</td> <td rowspan="2">≥ 100</td> <td>D.F. $< 2.5\%$</td> <td></td> </tr> <tr> <td>D.F. $< 3.0\%$</td> <td></td> </tr> </tbody> </table>	Dielectric	Rated Voltage (V)	Q/D.F.	Remark	Class I(NP0)	All	$Q\geq 1000$	Cap $\geq 30pF$	$Q\geq 400+20C$	Cap $< 30pF$	Class II(X7R)	≥ 100	D.F. $< 2.5\%$		D.F. $< 3.0\%$											
Dielectric	Rated Voltage (V)	Q/D.F.	Remark																									
Class I(NP0)	All	$Q\geq 1000$	Cap $\geq 30pF$																									
		$Q\geq 400+20C$	Cap $< 30pF$																									
Class II(X7R)	≥ 100	D.F. $< 2.5\%$																										
		D.F. $< 3.0\%$																										
Temperature Coefficient	<ul style="list-style-type: none"> * With no electrical load. <table border="1"> <thead> <tr> <th>T.C.</th> <th>Operation Temp.</th> </tr> </thead> <tbody> <tr> <td>C0G(NP0)</td> <td>-55~125°C at 25°C</td> </tr> <tr> <td>X7R</td> <td>-55~125°C at 25°C</td> </tr> </tbody> </table>	T.C.	Operation Temp.	C0G(NP0)	-55~125°C at 25°C	X7R	-55~125°C at 25°C	<table border="1"> <thead> <tr> <th>T.C.</th> <th>Capacitance Change</th> </tr> </thead> <tbody> <tr> <td>C0G(NP0)</td> <td>Within $\pm 30ppm/^{\circ}C$</td> </tr> <tr> <td>X7R</td> <td>Within $\pm 15\%$</td> </tr> </tbody> </table>	T.C.	Capacitance Change	C0G(NP0)	Within $\pm 30ppm/^{\circ}C$	X7R	Within $\pm 15\%$														
T.C.	Operation Temp.																											
C0G(NP0)	-55~125°C at 25°C																											
X7R	-55~125°C at 25°C																											
T.C.	Capacitance Change																											
C0G(NP0)	Within $\pm 30ppm/^{\circ}C$																											
X7R	Within $\pm 15\%$																											
Insulation Resistance	<ul style="list-style-type: none"> * To apply voltage at 500VDC for 60 sec. 	<table border="1"> <thead> <tr> <th>Dielectric</th> <th>Requirements</th> </tr> </thead> <tbody> <tr> <td>Class I (NP0)</td> <td>$\geq 100G\Omega$ or $RxC\geq 500\Omega\cdot F$ whichever is smaller</td> </tr> <tr> <td>Class II (X7R)</td> <td>$\geq 10G\Omega$ or $RxC\geq 100\Omega\cdot F$ whichever is smaller.</td> </tr> </tbody> </table>	Dielectric	Requirements	Class I (NP0)	$\geq 100G\Omega$ or $RxC\geq 500\Omega\cdot F$ whichever is smaller	Class II (X7R)	$\geq 10G\Omega$ or $RxC\geq 100\Omega\cdot F$ whichever is smaller.																				
Dielectric	Requirements																											
Class I (NP0)	$\geq 100G\Omega$ or $RxC\geq 500\Omega\cdot F$ whichever is smaller																											
Class II (X7R)	$\geq 10G\Omega$ or $RxC\geq 100\Omega\cdot F$ whichever is smaller.																											
Solderability	<ul style="list-style-type: none"> * Solder temperature: $235\pm 5^{\circ}C$ for (1206~1210) * Solder temperature: $245\pm 5^{\circ}C$ for (1808~2225) * Dipping time: 2 ± 0.5 sec. 	75% min. coverage of all metalized area.																										
Dielectric Strength	<table border="1"> <thead> <tr> <th>Rated Voltage</th> <th>Condition</th> </tr> </thead> <tbody> <tr> <td>$1000\leq V\leq 3000V$</td> <td>1.2 times of UR</td> </tr> <tr> <td>$3000<V\leq 5000V$</td> <td>1.1 times of UR</td> </tr> <tr> <td>$>5000V$</td> <td>1.0 times of UR</td> </tr> </tbody> </table> <ul style="list-style-type: none"> * Duration: 1 to 5 sec. * Charge and discharge current less than 50mA. 	Rated Voltage	Condition	$1000\leq V\leq 3000V$	1.2 times of UR	$3000<V\leq 5000V$	1.1 times of UR	$>5000V$	1.0 times of UR	* No evidence of damage or flashover during test.																		
Rated Voltage	Condition																											
$1000\leq V\leq 3000V$	1.2 times of UR																											
$3000<V\leq 5000V$	1.1 times of UR																											
$>5000V$	1.0 times of UR																											
Resistance to Soldering Heat	<ul style="list-style-type: none"> * Solder temperature: $260\pm 5^{\circ}C$ * Dipping time: 10 ± 1 sec * Preheating: 120 to 150°C for 1 minute before immerse the capacitor in a eutectic solder. * Before initial measurement (Class II only): Perform $150+0/-10^{\circ}C$ for 1 hr and then set for 48 ± 4 hrs at room temp. * Measurement to be made after keeping at room temp. for 24 ± 2 hrs (Class I) or 48 ± 4 hrs (Class II). 	<ul style="list-style-type: none"> * No remarkable damage. <table border="1"> <thead> <tr> <th>Dielectric</th> <th>Cap Change</th> <th>Q/D.F & IR</th> </tr> </thead> <tbody> <tr> <td>Class I (NP0)</td> <td>Within $\pm 2.5\%$ or $\pm 0.25pF$ whichever is larger.</td> <td rowspan="2">To meet Initial requirement</td> </tr> <tr> <td>Class II (X7R)</td> <td>within $\pm 7.5\%$</td> </tr> </tbody> </table>	Dielectric	Cap Change	Q/D.F & IR	Class I (NP0)	Within $\pm 2.5\%$ or $\pm 0.25pF$ whichever is larger.	To meet Initial requirement	Class II (X7R)	within $\pm 7.5\%$																		
Dielectric	Cap Change	Q/D.F & IR																										
Class I (NP0)	Within $\pm 2.5\%$ or $\pm 0.25pF$ whichever is larger.	To meet Initial requirement																										
Class II (X7R)	within $\pm 7.5\%$																											
Temperature Cycle	<ul style="list-style-type: none"> * Conduct the five cycles according to the temperatures and time. <table border="1"> <thead> <tr> <th>Step</th> <th>Temp. (°C)</th> <th>Time (min.)</th> </tr> </thead> <tbody> <tr> <td>1</td> <td>Min. operating temp. +0/-3</td> <td>30 ± 3</td> </tr> <tr> <td>2</td> <td>Room temp.</td> <td>2~3</td> </tr> <tr> <td>3</td> <td>Max. Operating temp. +3/-0</td> <td>30 ± 3</td> </tr> <tr> <td>4</td> <td>Room temp.</td> <td>2~3</td> </tr> </tbody> </table> <ul style="list-style-type: none"> * Before initial measurement (Class II only): Perform $150+0/-10^{\circ}C$ for 1 hr and then set for 48 ± 4 hrs at room temp. * Measurement to be made after keeping at room temp. for 24 ± 2 hrs (Class I) or 48 ± 4 hrs (Class II). 	Step	Temp. (°C)	Time (min.)	1	Min. operating temp. +0/-3	30 ± 3	2	Room temp.	2~3	3	Max. Operating temp. +3/-0	30 ± 3	4	Room temp.	2~3	<ul style="list-style-type: none"> * No remarkable damage. <table border="1"> <thead> <tr> <th>Dielectric</th> <th>I.R</th> <th>Cap Change</th> <th>Q/D.F</th> </tr> </thead> <tbody> <tr> <td>Class I(NP0)</td> <td rowspan="2">To meet Initial requirement</td> <td>Within $\pm 2.5\%$ or $\pm 0.25pF$ whichever is larger.</td> <td>$\leq 1.0(Q)$ × Initial requirement</td> </tr> <tr> <td>Class II(X7R)</td> <td>within $\pm 7.5\%$</td> <td>$\leq 1.5(D.F.)$ × Initial requirement</td> </tr> </tbody> </table>	Dielectric	I.R	Cap Change	Q/D.F	Class I(NP0)	To meet Initial requirement	Within $\pm 2.5\%$ or $\pm 0.25pF$ whichever is larger.	$\leq 1.0(Q)$ × Initial requirement	Class II(X7R)	within $\pm 7.5\%$	$\leq 1.5(D.F.)$ × Initial requirement
Step	Temp. (°C)	Time (min.)																										
1	Min. operating temp. +0/-3	30 ± 3																										
2	Room temp.	2~3																										
3	Max. Operating temp. +3/-0	30 ± 3																										
4	Room temp.	2~3																										
Dielectric	I.R	Cap Change	Q/D.F																									
Class I(NP0)	To meet Initial requirement	Within $\pm 2.5\%$ or $\pm 0.25pF$ whichever is larger.	$\leq 1.0(Q)$ × Initial requirement																									
Class II(X7R)		within $\pm 7.5\%$	$\leq 1.5(D.F.)$ × Initial requirement																									
Vibration Resistance	<ul style="list-style-type: none"> * Vibration frequency: 10~55 Hz/min. * Total amplitude: 1.5mm * Test time: 6 hrs. (Two hrs. each in three mutually perpendicular directions.) 	<ul style="list-style-type: none"> * No remarkable damage. * Cap change and Q/D.F.: To meet initial spec. 																										

Multilayer Ceramic Chip Capacitors

High Voltage Type $\geq 1KV$

HC Series

MERITEK

RELIABILITY TEST CONDITIONS AND REQUIREMENTS (CONTINUED)

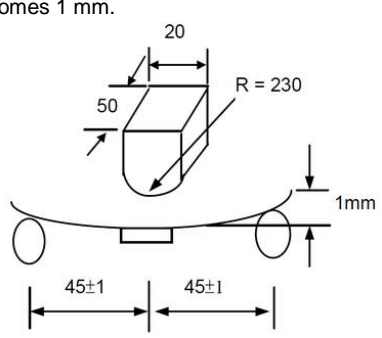
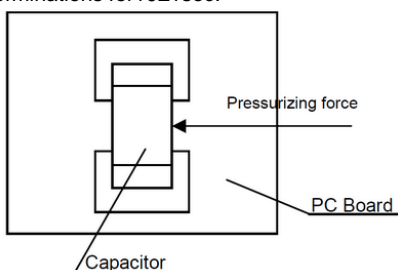
Item	Test Condition	Requirements																							
Humidity (Damp Heat) Steady State	<ul style="list-style-type: none"> * Test temp.: $40\pm 2^{\circ}C$ * Humidity: 90~95% RH * Test time: 500+24/-0hrs. * Measurement to be made after keeping at room temp. for 24 ± 2 hrs (Class I) or 48 ± 4 hrs (Class II), within $\pm 5.0\%$ or $\pm 0.5pF$ whichever is larger 	<p>* No remarkable damage.</p> <table border="1"> <thead> <tr> <th>Dielectric</th> <th>I.R</th> <th>Cap Change</th> <th>Q/D.F</th> </tr> </thead> <tbody> <tr> <td rowspan="2">Class I (NP0)</td> <td rowspan="2">$\geq 1G\Omega$ or $RxC \geq 50\Omega-F$ whichever is smaller.</td> <td>within $\pm 5.0\%$ or $\pm 0.5pF$ whichever is larger</td> <td>Cap $\geq 30pF$ Q≥ 350 10pF \leq Cap < 30pF Q$\geq 275+2.5C$</td> </tr> <tr> <td>within $\pm 12.5\%$</td> <td>Cap < 10pF Q$\geq 200+10C$</td> </tr> <tr> <td>Class II (X7R)</td> <td></td> <td></td> <td>D.F. $\leq 200\%$ \times Initial requirement</td> </tr> </tbody> </table>	Dielectric	I.R	Cap Change	Q/D.F	Class I (NP0)	$\geq 1G\Omega$ or $RxC \geq 50\Omega-F$ whichever is smaller.	within $\pm 5.0\%$ or $\pm 0.5pF$ whichever is larger	Cap $\geq 30pF$ Q ≥ 350 10pF \leq Cap < 30pF Q $\geq 275+2.5C$	within $\pm 12.5\%$	Cap < 10pF Q $\geq 200+10C$	Class II (X7R)			D.F. $\leq 200\%$ \times Initial requirement									
Dielectric	I.R	Cap Change	Q/D.F																						
Class I (NP0)	$\geq 1G\Omega$ or $RxC \geq 50\Omega-F$ whichever is smaller.	within $\pm 5.0\%$ or $\pm 0.5pF$ whichever is larger	Cap $\geq 30pF$ Q ≥ 350 10pF \leq Cap < 30pF Q $\geq 275+2.5C$																						
		within $\pm 12.5\%$	Cap < 10pF Q $\geq 200+10C$																						
Class II (X7R)			D.F. $\leq 200\%$ \times Initial requirement																						
Humidity (Damp Heat) Load	<ul style="list-style-type: none"> * Test temp.: $40\pm 2^{\circ}C$ * Humidity: 90~95% RH * Test time: 500+24/-0hrs. * To apply voltage :rated voltage * Measurement to be made after keeping at room temp. for 24 ± 2 hrs (Class I) or 48 ± 4 hrs (Class II). 	<p>* No remarkable damage.</p> <table border="1"> <thead> <tr> <th>Dielectric</th> <th>I.R</th> <th>Cap Change</th> <th>Q/D.F</th> </tr> </thead> <tbody> <tr> <td rowspan="2">Class I (NP0)</td> <td rowspan="2">$\geq 1G\Omega$ or $RxC \geq 50\Omega-F$ whichever is smaller.</td> <td>within $\pm 7.5\%$ or $\pm 0.75pF$ whichever is larger</td> <td>Cap $\geq 30pF$ Q≥ 350; 10pF \leq Cap < 30pF Q$\geq 275+2.5C$</td> </tr> <tr> <td>within $\pm 12.5\%$</td> <td>Cap < 10pF Q$\geq 200+10C$</td> </tr> <tr> <td>Class II (X7R)</td> <td></td> <td></td> <td>D.F. $\leq 200\%$ \times Initial requirement</td> </tr> </tbody> </table>	Dielectric	I.R	Cap Change	Q/D.F	Class I (NP0)	$\geq 1G\Omega$ or $RxC \geq 50\Omega-F$ whichever is smaller.	within $\pm 7.5\%$ or $\pm 0.75pF$ whichever is larger	Cap $\geq 30pF$ Q ≥ 350 ; 10pF \leq Cap < 30pF Q $\geq 275+2.5C$	within $\pm 12.5\%$	Cap < 10pF Q $\geq 200+10C$	Class II (X7R)			D.F. $\leq 200\%$ \times Initial requirement									
Dielectric	I.R	Cap Change	Q/D.F																						
Class I (NP0)	$\geq 1G\Omega$ or $RxC \geq 50\Omega-F$ whichever is smaller.	within $\pm 7.5\%$ or $\pm 0.75pF$ whichever is larger	Cap $\geq 30pF$ Q ≥ 350 ; 10pF \leq Cap < 30pF Q $\geq 275+2.5C$																						
		within $\pm 12.5\%$	Cap < 10pF Q $\geq 200+10C$																						
Class II (X7R)			D.F. $\leq 200\%$ \times Initial requirement																						
High Temperature Load (Endurance)	<ul style="list-style-type: none"> * Test temp.: NP0, X7R: $125\pm 3^{\circ}C$, Y5V: $85\pm 3^{\circ}C$ * Test time: 1000+24/-0 hrs. * Measurement to be made after keeping at room temp. for 48 ± 4 hrs. <table border="1"> <thead> <tr> <th>Dielectric</th> <th>Rated Voltage (V)</th> <th>Apply Voltage</th> </tr> </thead> <tbody> <tr> <td rowspan="3">NP0, X7R</td> <td>1000</td> <td>1.2 times of U_R</td> </tr> <tr> <td>1000 < V \leq 5000</td> <td>1.1 times of U_R</td> </tr> <tr> <td>>5000</td> <td>1.0 times of U_R</td> </tr> </tbody> </table>	Dielectric	Rated Voltage (V)	Apply Voltage	NP0, X7R	1000	1.2 times of U_R	1000 < V \leq 5000	1.1 times of U_R	>5000	1.0 times of U_R	<p>* No remarkable damage.</p> <table border="1"> <thead> <tr> <th>Dielectric</th> <th>I.R</th> <th>Cap Change</th> <th>Q/D.F</th> </tr> </thead> <tbody> <tr> <td rowspan="2">Class I (NP0)</td> <td rowspan="2">$\geq 1G\Omega$ or $RxC \geq 50\Omega-F$ whichever is smaller.</td> <td>within $\pm 3.0\%$ or $\pm 0.3pF$ whichever is larger</td> <td rowspan="2">D.F. $\leq 200\%$ \times Initial requirement</td> </tr> <tr> <td>within $\pm 12.5\%$</td> </tr> <tr> <td>Class II (X7R)</td> <td></td> <td></td> <td></td> </tr> </tbody> </table>	Dielectric	I.R	Cap Change	Q/D.F	Class I (NP0)	$\geq 1G\Omega$ or $RxC \geq 50\Omega-F$ whichever is smaller.	within $\pm 3.0\%$ or $\pm 0.3pF$ whichever is larger	D.F. $\leq 200\%$ \times Initial requirement	within $\pm 12.5\%$	Class II (X7R)			
Dielectric	Rated Voltage (V)	Apply Voltage																							
NP0, X7R	1000	1.2 times of U_R																							
	1000 < V \leq 5000	1.1 times of U_R																							
	>5000	1.0 times of U_R																							
Dielectric	I.R	Cap Change	Q/D.F																						
Class I (NP0)	$\geq 1G\Omega$ or $RxC \geq 50\Omega-F$ whichever is smaller.	within $\pm 3.0\%$ or $\pm 0.3pF$ whichever is larger	D.F. $\leq 200\%$ \times Initial requirement																						
		within $\pm 12.5\%$																							
Class II (X7R)																									
Resistance to Flexure of Substrate	<ul style="list-style-type: none"> * The middle part of substrate shall be pressurized by means of the pressurizing rod at a rate of about 1 mm per second until the deflection becomes 1 mm. 	<p>* No remarkable damage.</p> <table border="1"> <thead> <tr> <th>Dielectric</th> <th>Cap Change</th> </tr> </thead> <tbody> <tr> <td>Class I (NP0)</td> <td>within $\pm 3.0\%$ or $\pm 0.3pF$ whichever is larger</td> </tr> <tr> <td>Class II (X7R)</td> <td>within $\pm 12.5\%$</td> </tr> </tbody> </table> <p>(This capacitance change means the change of capacitance under specified flexure of substrate from the capacitance measured before the test.)</p>	Dielectric	Cap Change	Class I (NP0)	within $\pm 3.0\%$ or $\pm 0.3pF$ whichever is larger	Class II (X7R)	within $\pm 12.5\%$																	
Dielectric	Cap Change																								
Class I (NP0)	within $\pm 3.0\%$ or $\pm 0.3pF$ whichever is larger																								
Class II (X7R)	within $\pm 12.5\%$																								
Adhesive Strength of Termination	<ul style="list-style-type: none"> * Capacitors mounted on a substrate. A force of 10N applied perpendicular to the place of substrate and parallel the line joining the center of terminations for 10 ± 1 sec. 	<p>* No remarkable damage or removal of the terminations.</p>																							

Multilayer Ceramic Chip Capacitors

High Voltage Type $\geq 1KV$

HC Series

MERITEK

CAPACITANCE RANGE

X7R Dielectric

Dimension		0805	1206				1210			1808					1812				
Cap(pF)	code	1KV	1KV	1.5KV	2KV	1KV	1.5KV	2KV	1KV	1.5KV	2KV	3KV	4KV	1KV	1.5KV	2KV	3KV	4KV	
100	101	X	C	C	C														
120	121	X	C	C	C														
150	151	X	C	C	C				C	C	C	C	F						
180	181	X	C	C	C				C	C	C	C	F						
220	221	X	C	C	C	C	C	E	C	C	C	C	F						
270	271	X	C	C	C	C	C	E	C	C	C	C	F	C	C	C	E	F	
330	331	X	C	C	C	C	C	E	C	C	C	F	F	C	C	C	E	F	
390	391	X	C	C	C	C	C	E	C	C	C	F	F	C	C	C	E	F	
470	471	X	C	C	C	C	C	E	C	C	C	F	F	C	C	C	E	F	
560	561	X	C	C	C	C	C	E	C	C	C	F	F	C	C	C	E	F	
680	681	X	C	C	C	C	C	E	C	C	C	F	F	C	C	C	F	F	
820	821	X	C	C	C	C	C	E	C	C	C	F	F	C	C	C	F	F	
1000	102	X	C	C	C	C	C	E	C	C	C	F	F	C	C	C	F	F	
1200	122	X	C	E	E	C	F	F	C	F	F	F		C	C	C	F	G	
1500	152	C	C	E	E	C	F	F	C	F	F	F		C	C	C	F	G	
1800	182	C	C	E	E	C	F	F	C	F	F	F		C	C	E	G	G	
2200	222	C	C	E	E	C	F	F	C	F	F	F		C	C	E	G		
2700	272	C	C	E	E	C	G	G	C	F	F			C	C	E	G		
3300	332	C	C	E	E	C	G	G	C	F	F			C	F	F	G		
3900	392	C	C	E		E	G	G	C	F	F			C	F	F	G		
4700	472	C	C	E		E	G	G	C	F	F			C	F	F	G		
5600	562	C	C	E		E	G	G	F	F	F			C	G	G			
6800	682	C	C	E		E	G	G	F	F	F			C	G	G			
8200	822	C	C			E	G	G	F					C	G	G			
10000	103		C			E			F					E	G	G			
12000	123		E			E			F					F					
15000	153		E			E			F					F					
18000	183		E			E			F					G					
22000	223		E			E			F					G					
27000	273					E			F					G					
33000	333					E			F					G					
39000	393					F			F					G					
47000	473					G			F					G					
56000	563					G			F					G					
68000	683					G			F					G					
82000	823													G					
100000	104													G					
120000	124																		
150000	154																		

Multilayer Ceramic Chip Capacitors

High Voltage Type $\geq 1KV$

HC Series

MERITEK

CAPACITANCE RANGE (CONTINUED)

X7R Dielectric

Dimension		1825					2220					2225				
Cap(pF)	code	1KV	1.5KV	2KV	3KV	4KV	1KV	1.5KV	2KV	3KV	4KV	1KV	1.5KV	2KV	3KV	4KV
100	101															
120	121															
150	151															
180	181															
220	221															
270	271					F				F						F
330	331					F				F						F
390	391					F				F						F
470	471					F				F						F
560	561					F				F						F
680	681					F				F						F
820	821					F				F						F
1000	102	F	F	F	F	F	F	F	F	F	F	F	F	F	F	F
1200	122	F	F	F	F	G	F	F	F	F	G	F	F	F	F	G
1500	152	F	F	F	F	G	F	F	F	F	G	F	F	F	F	G
1800	182	F	F	F	F	G	F	F	F	F	G	F	F	F	F	G
2200	222	F	F	F	F		F	F	F	F		F	F	F	F	
2700	272	F	F	F	F		F	F	F	F		F	F	F	F	
3300	332	F	F	F	F		F	F	F	F		F	F	F	F	
3900	392	F	F	F	F		F	F	F	F		F	F	F	F	
4700	472	F	F	F	F		F	F	F	F		F	F	F	F	
5600	562	F	F	F	G		F	F	F	F		F	F	F	G	
6800	682	F	F	F	G		F	F	F	G		F	F	F	G	
8200	822	F	F	F	G		F	G	G	G		F	F	F	G	
10000	103	F	F	F	G		F	G	G	G		F	F	F	G	
12000	123	F	G	G	H		F	G	G	H		F	G	G	G	
15000	153	F	G	G	H		F	G	G	H		F	G	G	G	
18000	183	F	G	G	H		F	H	H	H		F	G	G	H	
22000	223	F	G	G			F	H	H			F	G	G		
27000	273	F	H	H			F	H	H			F	G	G		
33000	333	F	H	H			F	H	H			F	G	G		
39000	393	F	H	H			F	H	H			F	G	H		
47000	473	F	H	H			F	H	H			F	G	H		
56000	563	F	H	H			F	H	H			F	G	H		
68000	683	F					G					F	G			
82000	823	G					G					F	G			
100000	104	G					G					G	G			
120000	124	H					G					H				
150000	154	H					H					H				
180000	184	H					H					H				
220000	224	H					H					H				
270000	274	H					H					H				
330000	334	H					H					H				
390000	394						H					H				

Multilayer Ceramic Chip Capacitors

High Voltage Type $\geq 1KV$

HC Series

MERITEK

C0G Dielectric

Dimension		0805	1206		1210		1808				1812				1825			
Cap(pF)	code	1KV	1KV	2KV	1KV	2KV	1KV	2KV	3KV	4KV	1KV	2KV	3KV	4KV	1KV	2KV	3KV	4KV
0.5	0R5	C																
1.0	1R0	C																
1.2	1R2	C																
1.5	1R5	C	X	X														
1.8	1R8	C	X	X														
2.2	2R2	C	X	X			C	C	C	C								
2.7	2R7	C	X	X			C	C	C	C								
3.3	3R3	C	X	X			C	C	C	C								
3.9	3R9	C	X	X			C	C	C	C								
4.7	4R7	C	X	X			C	C	C	C								
5.6	5R6	C	X	X			C	C	C	C								
6.8	6R8	C	X	X			C	C	C	C								
8.2	8R2	C	X	X			C	C	C	C								
10	100	C	X	X	M	M	C	C	C	C	C	C	C	C	F	F	F	F
12	120	C	X	X	M	M	C	C	C	C	C	C	C	C	F	F	F	F
15	150	C	X	X	M	M	C	C	C	C	C	C	C	C	F	F	F	F
18	180	C	X	X	M	M	C	C	C	C	C	C	C	C	F	F	F	F
22	220	C	X	X	M	M	C	C	C	E	C	C	C	C	F	F	F	F
27	270	C	X	X	M	M	C	C	C	E	C	C	C	C	F	F	F	F
33	330	C	X	M	M	M	C	C	C	F	C	C	C	C	F	F	F	F
39	390	C	X	M	M	M	C	C	C	F	C	C	C	C	F	F	F	F
47	470	C	M	M	M	M	C	C	C		C	C	C	E	F	F	F	F
56	560	C	M	C	M	C	C	C	C		C	C	C	E	F	F	F	F
68	680	C	M	C	M	C	C	C	C		C	C	C	F	F	F	F	F
82	820	C	C	C	M	C	C	C	C		C	C	C	F	F	F	F	F
100	101	C	C	C	C	C	C	C	F		C	C	C		F	F	F	F
120	121	C	C	E	C	C	C	C	F		C	C	C		F	F	F	F
150	151	C	C	E	C	E	C	F	F		C	C	C		F	F	F	F
180	181	C	E	E	C	E	C	F	F		C	C	F		F	F	F	F
220	221	C	E	E	E	E	C	F	F		C	C	F		F	F	F	
270	271	C	E	E	E	E	F	F	F		C	F	F		F	F	F	
330	331	C	E	E	E	E	F	F	F		C	F	F		F	F	F	
390	391	C	E	E	E	E	F	F	F		C	F	F		F	F	F	
470	471		E	E	E	E	F	F	F		F	F	F		F	F	F	
560	561		E		E	E	F	F	F		F	F	F		F	F	F	
680	681		E		E	E	F	F			F	F	F		F	F	G	
820	821		E		E	E	F	F			F	F	G		F	F	G	
1000	102		E		E	F	F	F			F	F	G		F	F	G	
1200	122		E		E	F	F	F			F	F			F	F	G	
1500	152				F	G	F	F			F	F			F	G	G	
1800	182				G	G	F	F			F	F			F	G	G	
2200	222				G		F				F	F			F	G	G	
2700	272				G		F				F	G			F	G	G	
3300	332				G		F				F	G			F	G		
3900	392				G						G				G	G		
4700	472										G				G	G		
5600	562										G				G	G		
6800	682														G	G		
8200	822														G	G		
10000	103														G			
12000	123														G			

Multilayer Ceramic Chip Capacitors
High Voltage Type $\geq 1KV$

HC Series

MERITEK

CAPACITANCE RANGE (CONTINUED)

C0G Dielectric

Dimension		2220				2225			
Cap(pF)	code	1KV	2KV	3KV	4KV	1KV	2KV	3KV	4KV
0.5	0R5								
1.0	1R0								
1.5	1R5								
1.8	1R8								
2.2	2R2								
2.7	2R7								
3.3	3R3								
3.9	3R9								
4.7	4R7								
5.6	5R6								
6.8	6R8								
8.2	8R2								
10	100	F	F	F	F	F	F	F	F
12	120	F	F	F	F	F	F	F	F
15	150	F	F	F	F	F	F	F	F
18	180	F	F	F	F	F	F	F	F
22	220	F	F	F	F	F	F	F	F
27	270	F	F	F	F	F	F	F	F
33	330	F	F	F	F	F	F	F	F
39	390	F	F	F	F	F	F	F	F
47	470	F	F	F	F	F	F	F	F
56	560	F	F	F	F	F	F	F	F
68	680	F	F	F	F	F	F	F	F
82	820	F	F	F	F	F	F	F	F
100	101	F	F	F	F	F	F	F	F
120	121	F	F	F	F	F	F	F	F
150	151	F	F	F	F	F	F	F	F
180	181	F	F	F	F	F	F	F	F
220	221	F	F	F	F	F	F	F	F
270	271	F	F	F	G	F	F	F	F
330	331	F	F	G	G	F	F	F	G
390	391	F	F	G		F	F	F	
470	471	F	F	G		F	F	F	
560	561	F	F	G		F	F	F	
680	681	F	F	G		F	F	F	
820	821	F	F	G		F	G	G	
1000	102	F	F	G		F	G	G	
1200	122	G	G	G		F	G	G	
1500	152	G	G	G		F	G	G	
1800	182	G	G	G		F	G	G	
2200	222	G	G	G		F	G	G	
2700	272	G	G	G		F	G	G	
3300	332	G	G			F	G	G	
3900	392	G	G			F	G		
4700	472	G	G			F	G		
5600	562	G	G			G	G		
6800	682	G	G			G	G		
8200	822	G	G			G	G		
10000	103	G				G	G		
12000	123	G				G			

Multilayer Ceramic Chip Capacitors

High Voltage Type $\geq 1KV$

HC Series

MERITEK

PACKAGE DIMENSION

Paper Tape:

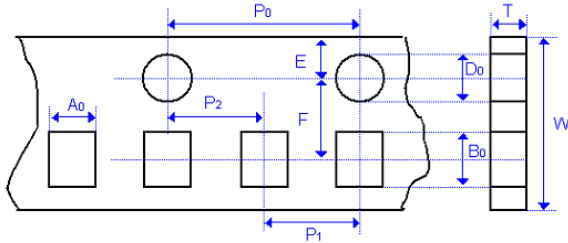

Plastic Tape:

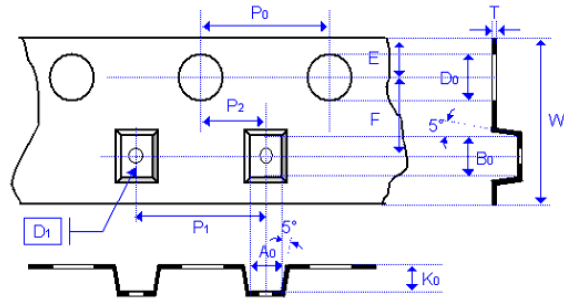

Size	0805		1206			1210		1808	
Chip Size	0.80 ± 0.10	1.25 ± 0.10	0.80 ± 0.10	0.95 ± 0.10 1.25 ± 0.10	1.60 ± 0.20 1.60+0.3/-0.1	0.95 ± 0.10 1.25 ± 0.10 1.60 ± 0.20 2.00 ± 0.20	2.50 ± 0.30	1.25 ± 0.10 1.40 ± 0.15 1.60 ± 0.20	2.00 ± 0.20
A_0	1.50 ± 0.10	<1.65	2.00 ± 0.10	<2.00	<2.00	<3.05	<3.10	<2.50	<2.50
B_0	2.30 ± 0.10	<2.40	3.50 ± 0.10	<3.60	<3.70	<3.80	<4.00	<5.30	<5.30
T	0.95 ± 0.05	0.23 ± 0.05	0.95 ± 0.05	0.23 ± 0.05	0.23 ± 0.05	0.23 ± 0.05	0.23 ± 0.05	0.25 ± 0.05	0.25 ± 0.05
K_0	-	<2.50	-	<2.50	<2.50	<2.50	<3.50	<2.50	<2.50
W	8.00 ± 0.10	8.00 ± 0.10	8.00 ± 0.10	8.00 ± 0.10	8.00 ± 0.10	8.00 ± 0.10	8.00 ± 0.10	12.0 ± 0.20	12.0 ± 0.20
P_0	4.00 ± 0.10	4.00 ± 0.10	4.00 ± 0.10	4.00 ± 0.10	4.00 ± 0.10	4.00 ± 0.100	4.00 ± 0.10	4.00 ± 0.10	4.00 ± 0.10
10x P_0	40.00 ± 0.20	40.00 ± 0.20	40.0 ± 0.20	40.00 ± 0.20	40.00 ± 0.20	40.00 ± 0.20	40.0 ± 0.20	40.0 ± 0.20	40.0 ± 0.20
P_1	4.00 ± 0.10	4.00 ± 0.10	4.00 ± 0.10	4.00 ± 0.10	4.00 ± 0.10	4.00 ± 0.10	4.00 ± 0.10	4.00 ± 0.10	4.00 ± 0.10
P_2	2.00 ± 0.05	2.00 ± 0.05	2.00 ± 0.05	2.00 ± 0.05	2.00 ± 0.05	2.00 ± 0.05	2.00 ± 0.05	2.00 ± 0.05	2.00 ± 0.05
D_0	1.55 ± 0.05	1.50 $\pm 0.1/-0$	1.50 ± 0.05	1.50 $\pm 0.1/-0$	1.50 $\pm 0.1/-0$	1.50 $\pm 0.1/-0$	1.50 $\pm 0.1/-0$	1.50 $\pm 0.1/-0$	1.50 $\pm 0.1/-0$
D_1	-	1.00 ± 0.10	-	1.00 ± 0.10	1.00 ± 0.10	1.00 ± 0.10	1.00 ± 0.10	1.50 ± 0.10	1.50 ± 0.10
E	1.75 ± 0.05	1.75 ± 0.10	1.75 ± 0.10	1.75 ± 0.10	1.75 ± 0.10	1.75 ± 0.10	1.75 ± 0.10	1.75 ± 0.10	1.75 ± 0.10
F	3.50 ± 0.05	3.50 ± 0.05	3.50 ± 0.05	3.50 ± 0.05	3.50 ± 0.05	3.50 ± 0.05	3.50 ± 0.05	5.50 ± 0.05	5.50 ± 0.05

Size	2211			1812		1825		2220		2225	
Chip Size	1.60 ± 0.20	2.00 ± 0.20	2.50 ± 0.20	2.00 ± 0.20	2.50 ± 0.30	2.00 ± 0.20	2.50 ± 0.30	1.40 ± 0.15 1.60 ± 0.20 2.00 ± 0.20	2.50 ± 0.30	2.00 ± 0.20	2.50 ± 0.30
A_0	< 3.30	< 3.30	< 3.30	<3.90	<3.90	<6.80	<6.80	<5.80	<5.80	<6.80	<6.80
B_0	< 6.50	< 6.50	< 6.50	<5.30	<5.30	<5.30	<5.30	<6.50	<6.50	<6.50	<6.50
T	0.30 ± 0.10	0.30 ± 0.10	0.30 ± 0.10	0.25 ± 0.05	0.25 ± 0.05	0.30 ± 0.10	0.30 ± 0.10	0.30 ± 0.10	0.30 ± 0.10	0.30 ± 0.10	0.30 ± 0.10
K_0	< 2.50	< 3.10	<2.50	<3.0	<2.50	<3.10	<2.50	<3.10	<2.50	<3.10	<3.10
W	12.0 ± 0.20	12.0 ± 0.20	12.0 ± 0.20	12.0 ± 0.20	12.0 ± 0.20	12.0 ± 0.20	12.0 ± 0.20	12.0 ± 0.20	12.0 ± 0.20	12.0 ± 0.20	12.0 ± 0.20
P_0	4.00 ± 0.10	4.00 ± 0.10	4.00 ± 0.10	4.00 ± 0.10	4.00 ± 0.10	4.00 ± 0.10	4.00 ± 0.10	4.00 ± 0.10	4.00 ± 0.10	4.00 ± 0.10	4.00 ± 0.10
10x P_0	40.00 ± 0.2	40.00 ± 0.2	40.00 ± 0.2	40.0 ± 0.20	40.00 ± 0.2	40.00 ± 0.2	40.00 ± 0.2	40.0 ± 0.20	40.0 ± 0.20	40.0 ± 0.20	40.0 ± 0.20
P_1	8.00 ± 0.10	8.00 ± 0.10	8.00 ± 0.10	8.00 ± 0.10	8.00 ± 0.10	8.00 ± 0.10	8.00 ± 0.10	8.00 ± 0.10	8.00 ± 0.10	8.00 ± 0.10	8.00 ± 0.10
P_2	2.00 ± 0.05	2.00 ± 0.05	2.00 ± 0.05	2.00 ± 0.05	2.00 ± 0.05	2.00 ± 0.05	2.00 ± 0.05	2.00 ± 0.05	2.00 ± 0.05	2.00 ± 0.05	2.00 ± 0.05
D_0	1.50 +0.10/-0	1.50 +0.10/-0	1.50 +0.10/-0	1.50 +0.10/-0	1.50 +0.10/-0	1.50 +0.10/-0	1.50 +0.10/-0	1.50 +0.10/-0	1.50 +0.10/-0	1.50 +0.10/-0	1.50 +0.10/-0
D_1	1.50 ± 0.10	1.50 ± 0.10	1.50 ± 0.10	1.50 ± 0.10	1.50+/-0.1	1.50 ± 0.10	1.50 ± 0.10	1.50 ± 0.10	1.50 ± 0.10	1.50 ± 0.10	1.50 ± 0.10
E	1.75 ± 0.1	1.75 ± 0.1	1.75 ± 0.1	1.75 ± 0.10	1.75+/-0.1	1.75 ± 0.1	1.75 ± 0.10	1.75 ± 0.1	1.75 ± 0.10	1.75 ± 0.10	1.75 ± 0.10
F	5.50 ± 0.05	5.50 ± 0.05	5.50 ± 0.05	5.50 ± 0.05	5.50+/-0.05	5.50 ± 0.05	5.50 ± 0.05	5.50 ± 0.05	5.50 ± 0.05	5.50 ± 0.05	5.50 ± 0.05

Multilayer Ceramic Chip Capacitors
High Voltage Type $\geq 1KV$

HC Series

MERITEK

PACKAGE DIMENSION (CONTINUED)

Size	0805, 1206, 1210, 1812			1808, 1812, 1825, 2220, 2225	2211
Reel Size	7"	10"	7"	7"	7"
C	13.0+0.5/-0.2	13.0+0.5/-0.2	13.0+0.5/-0.2	13.0+0.5/-0.2	13.0+0.5/-0.2
W1	8.4+1.5/-0	8.4+1.5/-0	12.4+2.0/-0	12.4+2.0/-0	12.4+2.0/-0
A	178.0±0.10	250.0±1.0	178.0±0.10	178.0±0.10	178.0±0.10
N	65.0±1.0	100.0±1.0	80.0±	60.5±1.0	80.0±1.0

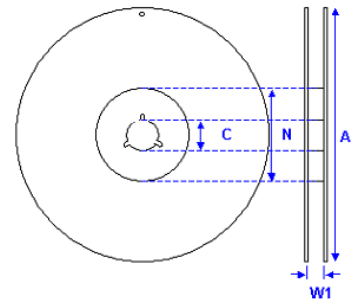

Reel DIMENSION AND QUANTITY

Size	Thickness (mm)	Paper Tape		Plastic Tape	
		7" reel	13" reel	7" reel	13" reel
0805 (2012)	0.80±0.10	4K	15K	-	-
	1.25±0.10	-	-	3K	10K
1206 (3216)	0.80±0.10	4K	15K	-	-
	0.95±0.10	-	-	3K	10K
	1.25±0.10	-	-	3K	10K
1210 (3225)	1.60±0.20	-	-	2K	-
	0.95±0.10	-	-	3K	10K
	1.25±0.10	-	-	3K	10K
	1.60±0.20	-	-	2K	-
	2.00±0.20	-	-	1K	-
1808 (4520)	2.50±0.30	-	-	1K	-
	1.25±0.10	-	-	2K	-
	1.40±0.15	-	-	2K	-
	1.60±0.20	-	-	2K	-
1812 (4563)	2.00±0.20	-	-	1K	-
	1.25±0.10	-	-	1K	-
	1.60±0.20	-	-	1K	-
	2.00±0.20	-	-	1k	-
1825 (4563)	2.50±0.30	-	-	0.5K	3K
	1.60±0.20	-	-	1K	-
	2.00±0.20	-	-	1K	-
2211 (5728)	2.50±0.30	-	-	0.5K	3K
	1.25±0.10	-	-	1K	-
	2.00±0.20	-	-	1K	-
2220 (5750)	2.50±0.30	-	-	0.5K	-
	1.60±0.20	-	-	1K	-
	2.00±0.20	-	-	1K	-
2225 (5763)	2.00±0.20	-	-	1K	-
	2.50±0.30	-	-	0.5K	-

Unit: pieces

Multilayer Ceramic Chip Capacitors

High Voltage Type $\geq 1KV$

HC Series

MERITEK

APPLICATION NOTES

STORAGE

To prevent the damage of solderability of terminations, the following storage conditions are recommended:

1. Indoors under 5°C~ 40°C and 20% ~ 70% RH.
2. No harmful gases containing sulfuric acid, ammonia, hydrogen sulfide or chlorine.

Packaging should not be opened until the capacitors are required for use. If opened, the pack should be re-sealed as soon as is practicable. Taped product should be stored out of direct sunlight, which might promote deterioration in tape or adhesion performance. The product is recommended to be used within 6 months and checked the solderability before use.

HANDLING

Chip capacitors are dense, hard, brittle, and abrasive materials. They are liable to suffer mechanical damage, in the form of cracks or chips. Chip Capacitors should be handled with care to avoid contamination or damage. To use vacuum or plastic tweezers to pick up or plastic tweezers is recommended for manual placement. Tape and reeled packages are suitable for automatic pick and placement machine.

PREHEAT

In order to minimize the risk of thermal shock during soldering, a carefully controlled preheat is required. The rate of preheat should not exceed 4°C per second. and the final preheat temperature should be within 100°C of the soldering temperature for small chips such as 0805,1206, within 50°C of the soldering temperature for bigger chips such as 1210, 1808, 1812, 1825, 2211, 2220 and 2225, etc.

SOLDERING

Use middy activated rosin RA and RMA fluxes do not use activated flux. The amount of solder in each solder joint should be controlled to prevent the damage of chip capacitors caused by the stress between solder, chips, and substrate. Hand soldering with temperature-controlled iron not exceeding 30 watts and diameter of tip less than 1.2 mm is recommended, tip of iron should not contact the ceramic body directly, and the temperature of iron should be set to not more than 260°C.

For bigger chips such as 1210, 1808, 1812, 2211, 2220 and 2225, etc. wave soldering and hand soldering are no recommended.

Refer IPC/JEDEC J-STD-020D Method recommended soldering profiles:

Reflow not sooner than 15 minutes and not longer than 4 hrs after removal from the temperature/humidity chamber, subject the sample to 3 cycle of the appropriate reflow conditions as the table description below.

Profile Feature		Pb-Free Assembly
Preheat/Soak	Temperature MIN (T_{smin})	150°C
	Temperature MAX. (T_{sMAX})	200°C
	Time(t_s) from (T_{smin} to T_{smax})	60~120 seconds
Ramp-up rate (T_L to T_P)		3°C/second max.
Liquidous Temperature (T_L)		217°C
Time(T_L) maintained above T_L		60~150 seconds
Pek package body temperature(T_P)		For user T_P must not exceed the classification temp 260°C For supplier T_P must equal or exceed the classification temp 260°C
Time(T_P)* within 5°C of the specified classification temperature(T_C)		30 seconds
Ramp-down rate (T_P to T_L)		6°C/second MAX.
Time 25°C to peak temperature 260°C		8 minutes MAX.

- Lead-free: Soldering temperature = 235 to 260°C, depending on product.
- Maximum temperature = Minimum temperature (235°C) + ΔT + Tolerance for oven process and measurement (5 ~ 7°C)
- Time at peak temperature = 10sec, Dwell above 217°C = 90sec, Ramping rate = 3°C/sec (heating) and 6°C/sec (heating).

Multilayer Ceramic Chip Capacitors High Voltage Type $\geq 1KV$

HC Series

MERITEK

APPLICATION NOTES (CONTINUED)

CLASSIFICATION REFLOW PROFILES

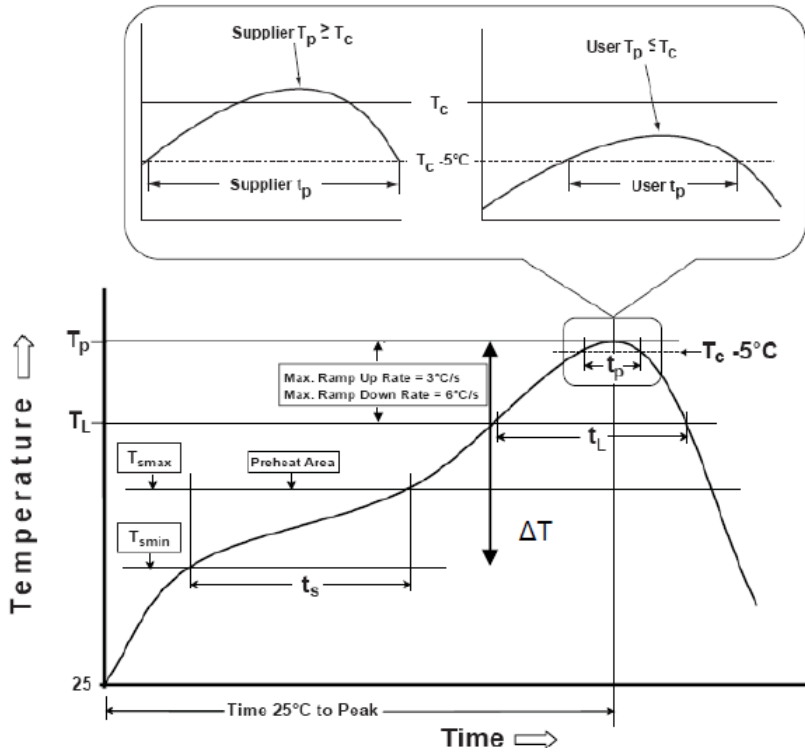

Chip Size	ΔT
0805, 1206	100°C
1210, 1808, 1812, 1825, 2211, 2220, 2225	50°C

Soldering	Solder Temp. (T_c)	Soldering Time (t_p)
Reflow	$235\sim 260^\circ\text{C}$	$< 15\text{sec.}$

Note:
For example: T_c is 260°C and time t_p is 15sec.
For user: The peak temperature must not exceed 260°C . The time above 255°C must not exceed 15 seconds.

COOLING

After soldering, cool the chips and the substrate gradually to room temperature. Natural cooling in air is recommended to minimize stress in the solder joint. A cooling rate not exceeding 4°C/s should be used when forced cooling is necessary.

CLEANING

All flux residues must be removed by using suitable electronic-grade vapor-cleaning solvents to eliminate contamination that could cause electrolytic surface corrosion. Good results can be obtained by using ultrasonic cleaning of the solvent. The choice of the proper system depends upon many factors such as component mix, flux, and solder paste and assembly method. The ability of the cleaning system to remove flux residues and contamination from under the chips is very important.

Looking for pricing, stock, or lifecycle information?

Click below to explore more details on WIN SOURCE:

-  [View HC1210CG100K202 on WIN SOURCE](#)
-  [Meritek Information](#)

Optimize Your Supply Chain with WIN SOURCE Solutions

-  Global Sourcing Solution
-  Obsolete Management
-  Cost Control Management
-  Shortage Management
-  Alternative Solution
-  Excess Inventory Management