



**THE DATASHEET OF
ELL-6GM5R6N**



SMD Choke Coils

Singapore

Series: **M**

Type: **ELL6□M**



Type ELL6□M

■ Features

- Magnetic shielded structure
- Low DC resistance and large current capability
- Shock resistant
- Available on tape and reel for automatic insertion

■ Recommended Applications

- DC/DC converter circuitry for computer peripherals and cellular hand sets.
- Chopper circuit decoupling chokes in DC/DC converter circuitry

■ Standard Packing Quantity

- 1000 pcs./Reel

■ Explanation of Part Numbers

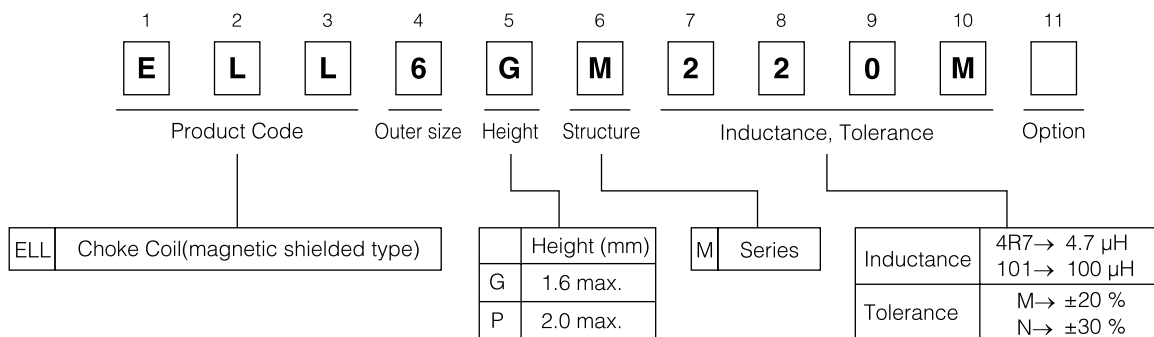

■ Dimensions in mm (not to scale)

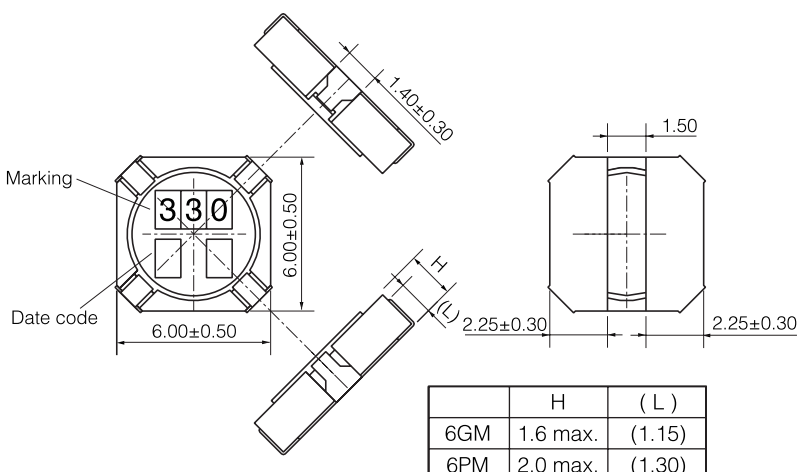

■ Recommended Land Pattern in mm (not to scale)

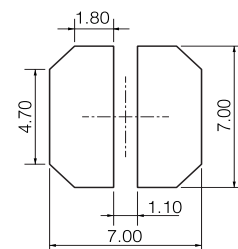

Standard Parts

Part No.	Inductance (100 kHz)		Rdc (at 20 °C)		*Current (mA) max.	Marking
	(μH)	Tolerance	(mΩ)	Tolerance		
ELL6GM1R2N	1.2	±30 %	23	±20 %	2300	1R2
ELL6GM1R8N	1.8		28		1900	1R8
ELL6GM2R2N	2.2		35		1800	2R2
ELL6GM2R7N	2.7		41		1700	2R7
ELL6GM3R6N	3.6		57		1500	3R6
ELL6GM4R7N	4.7		78		1250	4R7
ELL6GM5R6N	5.6		86		1200	5R6
ELL6GM6R8N	6.8		96		1100	6R8
ELL6GM7R5N	7.5		110		1050	7R5
ELL6GM100M	10.0		150		930	100
ELL6GM120M	12.0	170	830	120		
ELL6GM150M	15.0	190	740	150		
ELL6GM180M	18.0	260	710	180		
ELL6GM220M	22.0	320	620	220		
ELL6GM270M	27.0	350	560	270		
ELL6GM330M	33.0	490	500	330		
ELL6GM390M	39.0	550	460	390		
ELL6GM470M	47.0	620	420	470		
ELL6GM560M	56.0	700	380	560		
ELL6GM680M	68.0	820	350	680		
ELL6PM1R0N	1.0	±30 %	16	±20 %	2700	1R0
ELL6PM1R5N	1.5		20		2450	1R5
ELL6PM2R0N	2.0		24		2200	2R0
ELL6PM2R7N	2.7		29		2000	2R7
ELL6PM3R3N	3.3		35		1850	3R3
ELL6PM3R9N	3.9		40		1800	3R9
ELL6PM4R7N	4.7		47		1680	4R7
ELL6PM5R6N	5.6		52		1500	5R6
ELL6PM6R8N	6.8		57		1350	6R8
ELL6PM7R5N	7.5		70		1300	7R5
ELL6PM9R1N	9.1	77	1200	9R1		
ELL6PM100M	10.0	85	1000	100		
ELL6PM120M	12.0	110	950	120		
ELL6PM150M	15.0	130	900	150		
ELL6PM180M	18.0	140	820	180		
ELL6PM220M	22.0	200	700	220		
ELL6PM270M	27.0	220	620	270		
ELL6PM330M	33.0	290	550	330		
ELL6PM390M	39.0	310	520	390		
ELL6PM470M	47.0	360	440	470		
ELL6PM560M	56.0	500	420	560		
ELL6PM680M	68.0	600	400	680		
ELL6PM820M	82.0	680	360	820		
ELL6PM101M	100.0	970	320	101		

* Current: This indicates the value of current when the inductance is 70 % of nominal value or when the case temperature has risen 45 °C (at 20 °C)

Embossed Carrier Tape Dimensions in mm (not to scale)

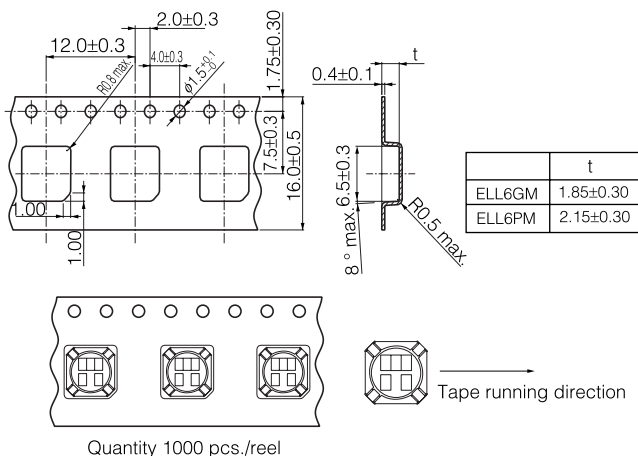

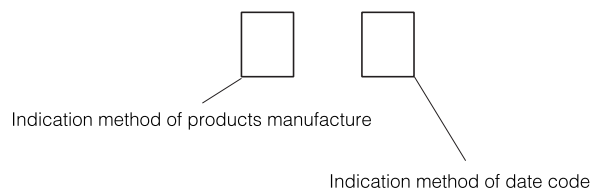

Date code



Year	Month	1	2	3	4	5	6	7	8	9	10	11	12
	Odd year		A	B	C	D	E	F	H	I	J	K	L
Even year		N	O	P	R	S	T	U	V	W	X	Y	Z

Looking for pricing, stock, or lifecycle information?

Click below to explore more details on WIN SOURCE:

-  [View ELL-6GM5R6N on WIN SOURCE](#)
-  [Panasonic Information](#)

Optimize Your Supply Chain with WIN SOURCE Solutions

-  Global Sourcing Solution
-  Obsolete Management
-  Cost Control Management
-  Shortage Management
-  Alternative Solution
-  Excess Inventory Management