



**THE DATASHEET OF  
EK42520-03**



**Product Description**

The PE42520 SPDT absorptive RF switch is designed for use in Test/ATE and other high performance wireless applications. This broadband general purpose switch maintains excellent RF performance and linearity from 9 kHz through 13 GHz. This switch is a pin-compatible upgraded version of PE42552 with higher power handling of 36 dBm continuous wave (CW) and 38 dBm instantaneous power in 50Ω @ 8 GHz. The PE42520 exhibits high isolation, fast settling time, and is offered in a 3 × 3 mm QFN package.

The PE42520 is manufactured on pSemi’s UltraCMOS® process, a patented variation of silicon-on-insulator (SOI) technology on a sapphire substrate, offering the performance of GaAs with the economy and integration

**Features**

- HaRP™ technology enhanced
  - Fast settling time
  - No gate and phase lag
  - No drift in insertion loss and phase
- High power handling @ 8 GHz in 50Ω
  - 36 dBm CW
  - 38 dBm instantaneous power
  - 26 dBm terminated port
- High linearity
  - 66 dBm IIP3
- Low insertion loss
  - 0.8 dB @ 3 GHz
  - 0.9 dB @ 10 GHz
  - 2.0 dB @ 13 GHz
- High isolation
  - 45 dB @ 3 GHz
  - 31 dB @ 10 GHz
  - 18 dB @ 13 GHz
- ESD performance
  - 4 kV HBM on RF pins to GND
  - 2.5 kV HBM on all pins
  - 1 kV CDM on all pins

**Figure 1. Functional Diagram**

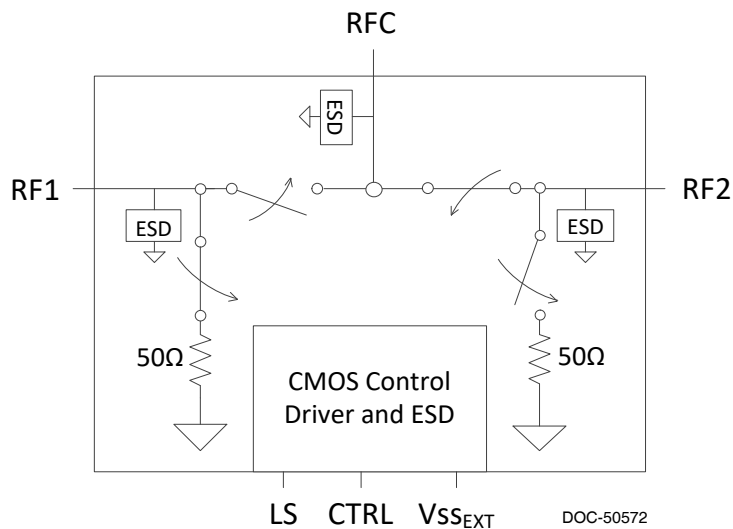

**Figure 2. Package Type**  
16-lead 3 × 3 mm QFN

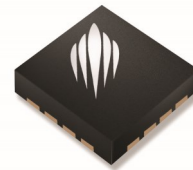

**Table 1. Electrical Specifications @ +25 °C,  $V_{DD} = 3.3V$ ,  $V_{SS\_EXT} = 0V$  or  $V_{DD} = 3.4V$ ,  $V_{SS\_EXT} = -3.4V$ , ( $Z_S = Z_L = 50\Omega$ ), unless otherwise noted**

| Parameter                                  | Path    | Condition                             | Min   | Typ           | Max    | Unit     |
|--|---------|---------------------------------------|-------|---------------|--------|----------|
| Operation frequency                        |         |                                       | 9 kHz |               | 13 GHz | As shown |
| Insertion loss                             | RFC-RFX | 9 kHz–10 MHz                          |       | 0.60          | 0.80   | dB       |
|  |         | 10 MHz–3 GHz                          |       | 0.80          | 1.00   | dB       |
|  |         | 3 GHz–7.5 GHz                         |       | 0.85          | 1.05   | dB       |
|  |         | 7.5 GHz–10 GHz                        |       | 0.90          | 1.10   | dB       |
|  |         | 10 GHz–12 GHz                         |       | 1.20          | 1.65   | dB       |
|  |         | 12 GHz–13 GHz                         |       | 2.00          | 2.70   | dB       |
| Isolation                                  | RFX-RFX | 9 kHz–10 MHz                          | 70    | 90            |        | dB       |
|  |         | 10 MHz–3 GHz                          | 46    | 54            |        | dB       |
|  |         | 3 GHz–7.5 GHz                         | 35    | 38            |        | dB       |
|  |         | 7.5 GHz–10 GHz                        | 24    | 27            |        | dB       |
|  |         | 10 GHz–12 GHz                         | 16    | 19            |        | dB       |
|  |         | 12 GHz–13 GHz                         | 13    | 17            |        | dB       |
| Isolation                                  | RFC-RFX | 9 kHz–10 MHz                          | 80    | 90            |        | dB       |
|  |         | 10 MHz–3 GHz                          | 42    | 45            |        | dB       |
|  |         | 3 GHz–7.5 GHz                         | 41    | 44            |        | dB       |
|  |         | 7.5 GHz–10 GHz                        | 26    | 31            |        | dB       |
|  |         | 10 GHz–12 GHz                         | 16    | 20            |        | dB       |
|  |         | 12 GHz–13 GHz                         | 13    | 18            |        | dB       |
| Return loss (active port)                  | RFC-RFX | 9 kHz–10 MHz                          |       | 23            |        | dB       |
|  |         | 10 MHz–3 GHz                          |       | 17            |        | dB       |
|  |         | 3 GHz–7.5 GHz                         |       | 15            |        | dB       |
|  |         | 7.5 GHz–10 GHz                        |       | 18            |        | dB       |
|  |         | 10 GHz–12 GHz                         |       | 20            |        | dB       |
|  |         | 12 GHz–13 GHz                         |       | 10            |        | dB       |
| Return loss (common port)                  | RFC-RFX | 9 kHz–10 MHz                          |       | 23            |        | dB       |
|  |         | 10 MHz–3 GHz                          |       | 17            |        | dB       |
|  |         | 3 GHz–7.5 GHz                         |       | 15            |        | dB       |
|  |         | 7.5 GHz–10 GHz                        |       | 18            |        | dB       |
|  |         | 10 GHz–12 GHz                         |       | 18            |        | dB       |
|  |         | 12 GHz–13 GHz                         |       | 10            |        | dB       |
| Return loss (terminated port)              | RFX     | 9 kHz–10 MHz                          |       | 32            |        | dB       |
|  |         | 10 MHz–3 GHz                          |       | 24            |        | dB       |
|  |         | 3 GHz–7.5 GHz                         |       | 21            |        | dB       |
|  |         | 7.5 GHz–10 GHz                        |       | 13            |        | dB       |
|  |         | 10 GHz–12 GHz                         |       | 8             |        | dB       |
|  |         | 12 GHz–13 GHz                         |       | 5             |        | dB       |
| Input 0.1dB compression point <sup>1</sup> | RFC-RFX | 10 MHz–13 GHz                         |       | <i>Fig. 5</i> |        | dBm      |
| Input IP2                                  | RFC-RFX | 834 MHz, 1950 MHz                     |       | 120           |        | dBm      |
| Input IP3                                  | RFC-RFX | 834 MHz, 1950 MHz, and 2700 MHz       |       | 66            |        | dBm      |
| Settling time                              |         | 50% CTRL to 0.05 dB final value       |       | 15            | 20     | $\mu$ s  |
| Switching time                             |         | 50% CTRL to 90% or 10% of final value |       | 5.5           | 9.5    | $\mu$ s  |

Note 1: The input 0.1dB compression point is a linearity figure of merit. Refer to Table 3 for the RF input power  $P_{IN}$  (50 $\Omega$ ).

Figure 3. Pin Configuration (Top View)

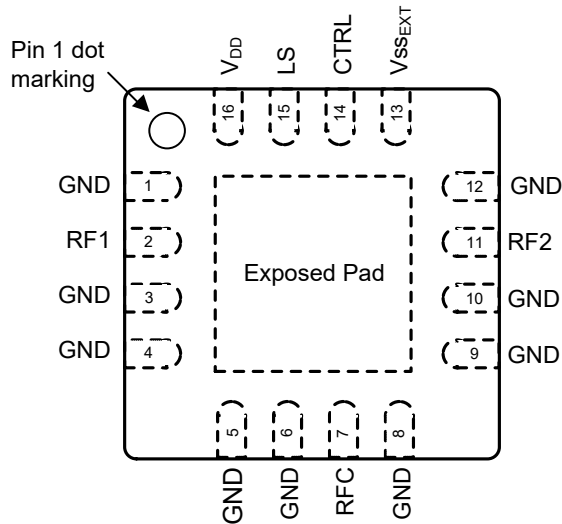

Table 2. Pin Descriptions

| Pin #                       | Pin Name                         | Description  |
|-----------------------------|----------------------------------|--|
| 2                           | RF1 <sup>1</sup>                 | RF port 1  |
| 1, 3, 4, 5, 6, 8, 9, 10, 12 | GND                              | Ground   |
| 7                           | RFC <sup>1</sup>                 | RF common  |
| 11                          | RF2 <sup>1</sup>                 | RF port 2  |
| 13                          | V <sub>SS_EXT</sub> <sup>2</sup> | External V <sub>SS</sub> negative voltage control                              |
| 14                          | CTRL                             | Digital control logic input  |
| 15                          | LS                               | Logic Select – used to determine the definition for the CTRL pin (see Table 5) |
| 16                          | V <sub>DD</sub>                  | Supply voltage   |
| Pad                         | GND                              | Exposed pad: ground for proper operation                                       |

Notes: 1. RF pins 2, 7 and 11 must be at 0 VDC. The RF pins do not require DC blocking capacitors for proper operation if the 0 VDC requirement is met.  
2. Use V<sub>SS\_EXT</sub> (pin 13) to bypass and disable internal negative voltage generator. Connect V<sub>SS\_EXT</sub> (pin 13) to GND (V<sub>SS\_EXT</sub> = 0V) to enable internal negative voltage generator.

Table 3. Operating Ranges

| Parameter  | Symbol                 | Min             | Typ    | Max    | Unit |
|--|------------------------|-----------------|--------|--------|------|
| Supply voltage (normal mode, V <sub>SS_EXT</sub> = 0V) <sup>1</sup>  | V <sub>DD</sub>        | 2.3             |        | 5.5    | V    |
| Supply voltage (bypass mode, V <sub>SS_EXT</sub> = -3.4V, V <sub>DD</sub> ≥ 3.4V for full spec. compliance) <sup>2</sup> | V <sub>DD</sub>        | 2.7             | 3.4    | 5.5    | V    |
| Negative supply voltage (bypass mode) <sup>2</sup>   | V <sub>SS_EXT</sub>    | -3.6            |        | -3.2   | V    |
| Supply current (normal mode, V <sub>SS_EXT</sub> = 0V) <sup>1</sup>  | I <sub>DD</sub>        |                 | 120    | 200    | μA   |
| Supply current (bypass mode, V <sub>SS_EXT</sub> = -3.4V) <sup>2</sup>   | I <sub>DD</sub>        |                 | 50     | 80     | μA   |
| Negative supply current (bypass mode, V <sub>SS_EXT</sub> = -3.4V) <sup>2</sup>  | I <sub>SS</sub>        | -40             | -16    |        | μA   |
| Digital input high (CTRL)  | V <sub>IH</sub>        | 1.17            |        | 3.6    | V    |
| Digital input low (CTRL)   | V <sub>IL</sub>        | -0.3            |        | 0.6    | V    |
| Digital input current  | I <sub>CTRL</sub>      |                 |        | 10     | μA   |
| RF input power, CW (RFC–RFX) <sup>3</sup>  | P <sub>IN_CW</sub>     | 9 kHz ≤ 10 MHz  |        | Fig. 4 | dBm  |
| 10 MHz ≤ 8 GHz   |                        |                 | 36     |        |      |
| 8 GHz ≤ 13 GHz   |                        |                 | Fig. 5 |        |      |
| RF input power, pulsed (RFC–RFX) <sup>4</sup>  | P <sub>IN_PULSED</sub> | 9 kHz ≤ 10 MHz  |        | Fig. 4 | dBm  |
| 10 MHz ≤ 13 GHz  |                        |                 | Fig. 5 |        |      |
| RF input power, hot switch, CW <sup>3</sup>  | P <sub>IN_HOT</sub>    | 9 kHz ≤ 300 kHz |        | Fig. 4 | dBm  |
| 300 kHz ≤ 13 GHz   |                        |                 | 20     |        |      |
| RF input power into terminated ports, CW (RFX) <sup>3</sup>  | P <sub>IN_TERM</sub>   | 9 kHz ≤ 600 kHz |        | Fig. 4 | dBm  |
| 600 kHz ≤ 13 GHz   |                        |                 | 26     |        |      |
| Operating temperature range  | T <sub>OP</sub>        | -40             | +25    | +85    | °C   |

Notes: 1. Normal mode: connect V<sub>SS\_EXT</sub> (pin 13) to GND (V<sub>SS\_EXT</sub> = 0V) to enable internal negative voltage generator.  
2. Bypass mode: use V<sub>SS\_EXT</sub> (pin 13) to bypass and disable internal negative voltage generator.  
3. 100% duty cycle, all bands, 50Ω.  
4. Pulsed, 5% duty cycle of 4620 μs period, 50Ω.

**Table 4. Absolute Maximum Ratings**

| Parameter/Condition   | Symbol           | Min    | Max    | Unit |
|---|------------------|--------|--------|------|
| Supply voltage  | $V_{DD}$         | -0.3   | 5.5    | V    |
| Digital input voltage (CTRL)                                | $V_{CTRL}$       | -0.3   | 3.6    | V    |
| LS input voltage  | $V_{LS}$         | -0.3   | 3.6    | V    |
| RF input power, CW (RFC–RFX) <sup>1</sup>                   | $P_{IN\_CW}$     |        |        |      |
| 9 kHz ≤ 10 MHz  |                  |        | Fig. 4 | dBm  |
| 10 MHz ≤ 8 GHz  |                  | 36     | Fig. 5 |      |
| 8 GHz ≤ 13 GHz  |                  |        |        |      |
| RF input power, pulsed (RFC–RFX) <sup>2</sup>               | $P_{IN\_PULSED}$ |        |        |      |
| 9 kHz ≤ 10 MHz  |                  |        | Fig. 4 | dBm  |
| 10 MHz ≤ 13 GHz   |                  | Fig. 5 |        |      |
| RF input power into terminated ports, CW (RFX) <sup>1</sup> | $P_{IN\_TERM}$   |        |        |      |
| 9 kHz ≤ 10 MHz  |                  |        | Fig. 4 | dBm  |
| 10 MHz ≤ 13 GHz   |                  | 26     |        |      |
| Maximum junction temperature                                | $T_{J\_MAX}$     |        | +150   | °C   |
| Storage temperature range                                   | $T_{ST}$         | -65    | +150   | °C   |
| ESD voltage HBM <sup>3</sup>                                | $V_{ESD\_HBM}$   |        | 4000   | V    |
| RF pins to GND  |                  | 2500   | V      |      |
| All pins  |                  |        |        |      |
| ESD voltage MM <sup>4</sup> , all pins                      | $V_{ESD\_MM}$    |        | 200    | V    |
| ESD voltage CDM <sup>5</sup> , all pins                     | $V_{ESD\_CDM}$   |        | 1000   | V    |

Notes: 1. 100% duty cycle, all bands, 50Ω.  
 2. Pulsed, 5% duty cycle of 4620 μs period, 50Ω.  
 3. Human Body Model (MIL-STD 883 Method 3015).  
 4. Machine Model (JEDEC JESD22-A115).  
 5. Charged Device Model (JEDEC JESD22-C101).

Exceeding absolute maximum ratings may cause permanent damage. Operation should be restricted to the limits in the Operating Ranges table. Operation between operating range maximum and absolute maximum for extended periods may reduce reliability.

### Electrostatic Discharge (ESD) Precautions

When handling this UltraCMOS device, observe the same precautions that you would use with other ESD-sensitive devices. Although this device contains circuitry to protect it from damage due to ESD, precautions should be taken to avoid exceeding the rating specified.

### Latch-up Avoidance

Unlike conventional CMOS devices, UltraCMOS devices are immune to latch-up.

### Switching Frequency

The PE42520 has a maximum 25 kHz switching rate when the internal negative voltage generator is used (pin 13 = GND). The rate at which the PE42520 can be switched is only limited to the switching time (*Table 1*) if an external negative supply is provided (pin 13 =  $V_{SS\_EXT}$ ).

Switching frequency describes the time duration between switching events. Switching time is the time duration between the point the control signal reaches 50% of the final value and the point the output signal reaches within 10% or 90% of its

### Optional External Vss Control ( $V_{SS\_EXT}$ )

For proper operation, the  $V_{SS\_EXT}$  control pin must be grounded or tied to the  $V_{SS}$  voltage specified in *Table 3*. When the  $V_{SS\_EXT}$  control pin is grounded, FETs in the switch are biased with an internal negative voltage generator. For applications that require the lowest possible spur performance,  $V_{SS\_EXT}$  can be applied externally to bypass the

### Spurious Performance

The typical spurious performance of the PE42520 is -152 dBm when  $V_{SS\_EXT} = 0V$  (pin 13 = GND). If further improvement is desired, the internal negative voltage generator can be disabled by setting  $V_{SS\_EXT} = -3.4V$ .

**Table 5. Control Logic Truth Table**

| LS | CTRL | RFC–RF1 | RFC–RF2 |
|----|------|---------|---------|
| 0  | 0    | off     | on      |
| 0  | 1    | on      | off     |
| 1  | 0    | on      | off     |
| 1  | 1    | off     | on      |

### Moisture Sensitivity Level

The Moisture Sensitivity Level rating for the PE42520 in the 16-lead 3 × 3 mm QFN package is MSL3.

### Logic Select (LS)

The Logic Select feature is used to determine the definition for the CTRL pin.

### Thermal Data

Psi-JT ( $\Psi_{JT}$ ), junction top-of-package, is a thermal metric to estimate junction temperature of a device on the customer application PCB (JEDEC JESD51-2).

$$\Psi_{JT} = (T_J - T_T)/P$$

where

$\Psi_{JT}$  = junction-to-top of package characterization parameter, °C/W

$T_J$  = die junction temperature, °C

$T_T$  = package temperature (top surface, in the center), °C

P = power dissipated by device, Watts

**Table 6. Thermal Data for PE42520**

| Parameter  | Typ | Unit |
|--|-----|------|
| $\Psi_{JT}$  | 51  | °C/W |
| $\theta_{JA}$ , junction-to-ambient thermal resistance | 79  | °C/W |

**Figure 4. Power De-rating Curve for 9 kHz–10 MHz (50Ω)**

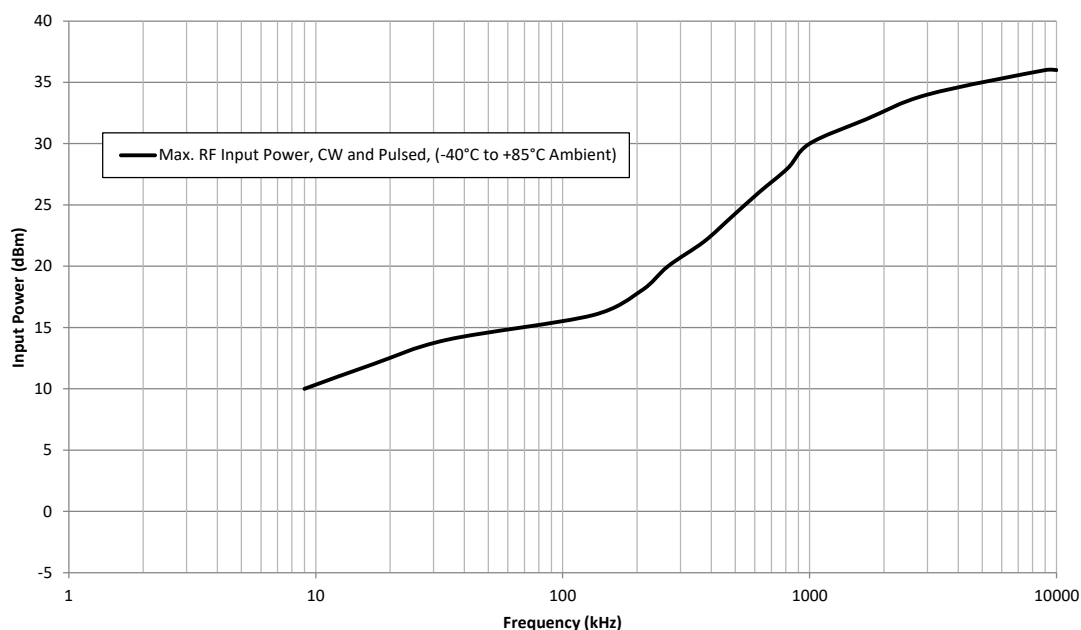

Figure 5a. Power De-rating Curve for 10 MHz–13 GHz @ +25 °C Ambient (50Ω)

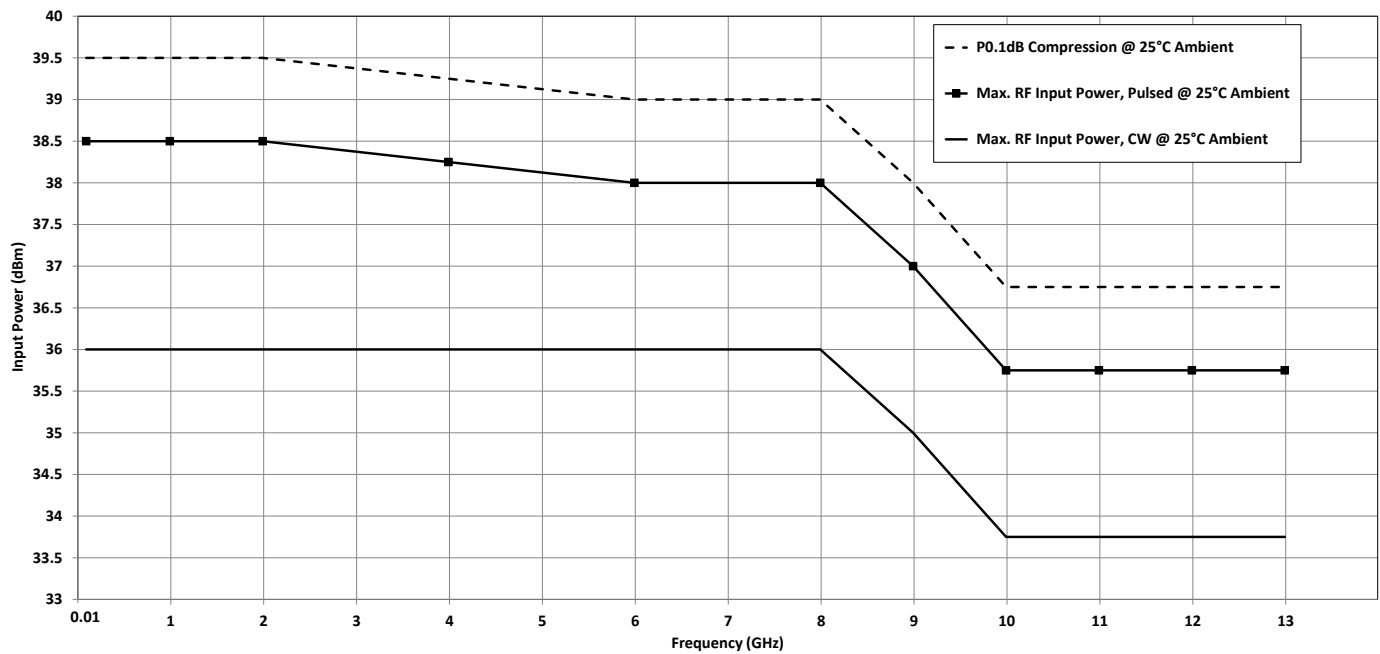
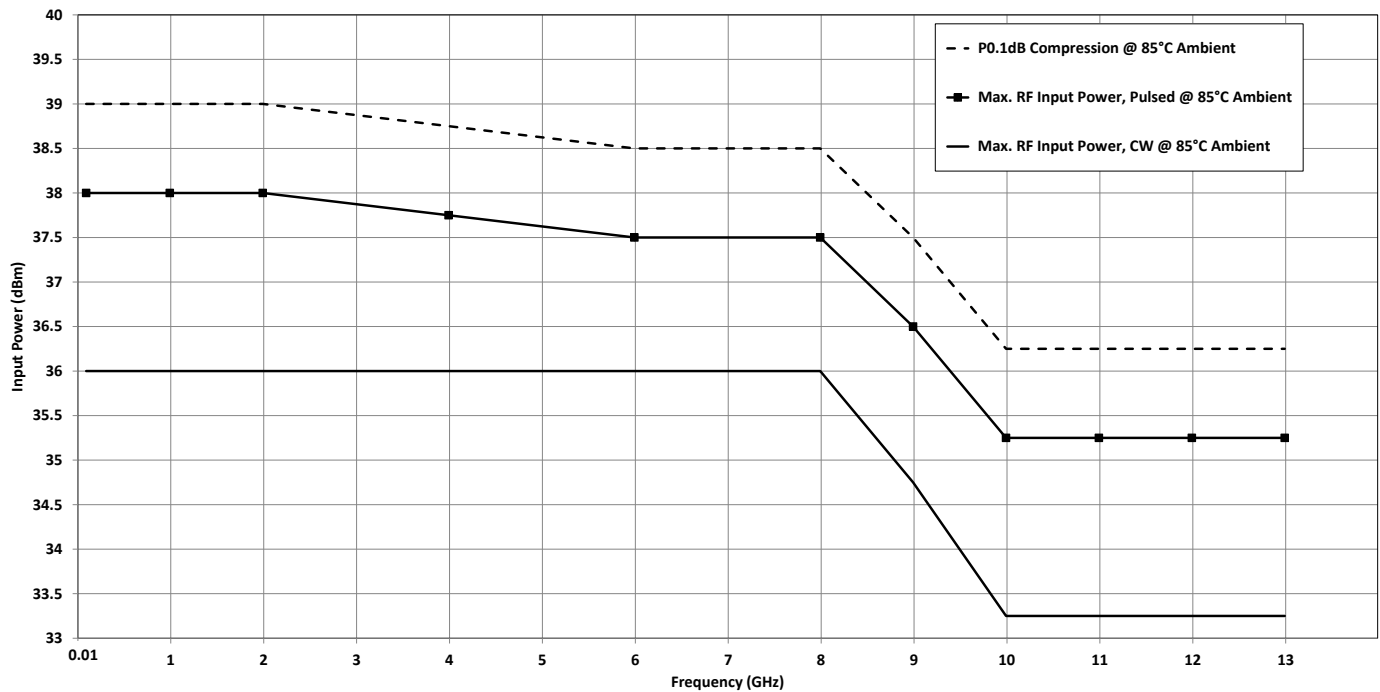

Figure 5b. Power De-rating Curve for 10 MHz–13 GHz @ +85 °C Ambient (50Ω)



Typical Performance Data @ +25 °C and  $V_{DD} = 3.4V$ , unless otherwise specified

Figure 6. Insertion Loss vs. Temp (RFC–RF1)

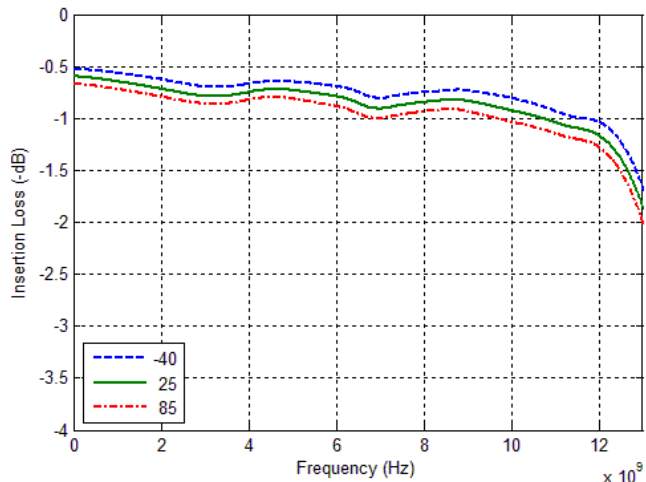

Figure 7. Insertion Loss vs.  $V_{DD}$  (RFC–RF1)

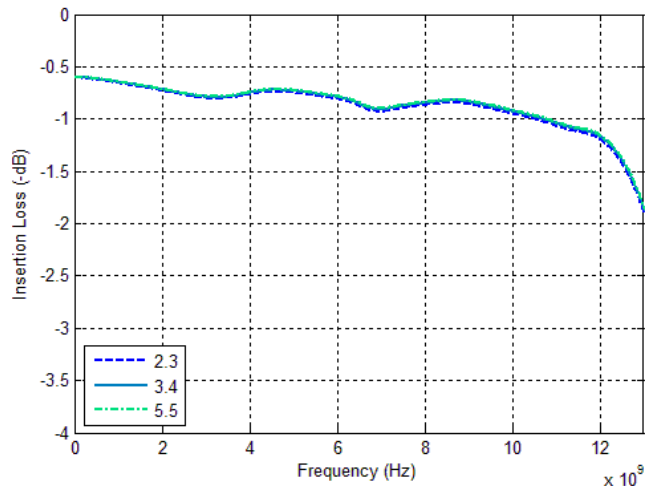

Figure 8. Insertion Loss vs. Temp (RFC–RF2)

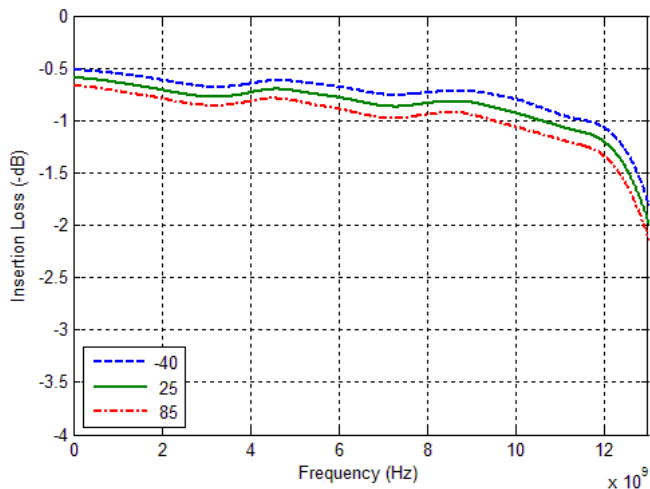
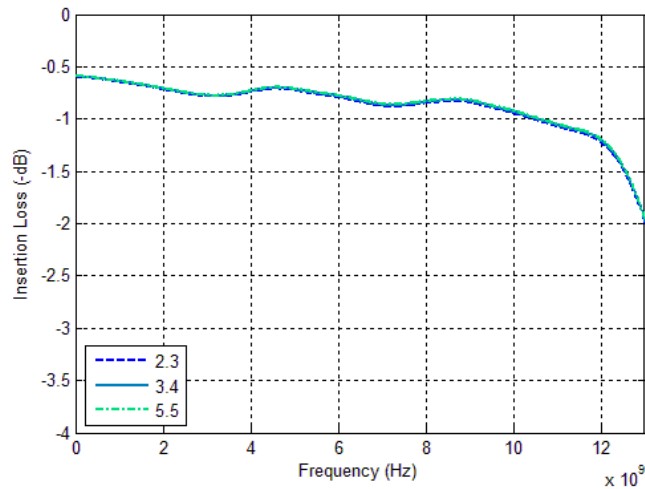
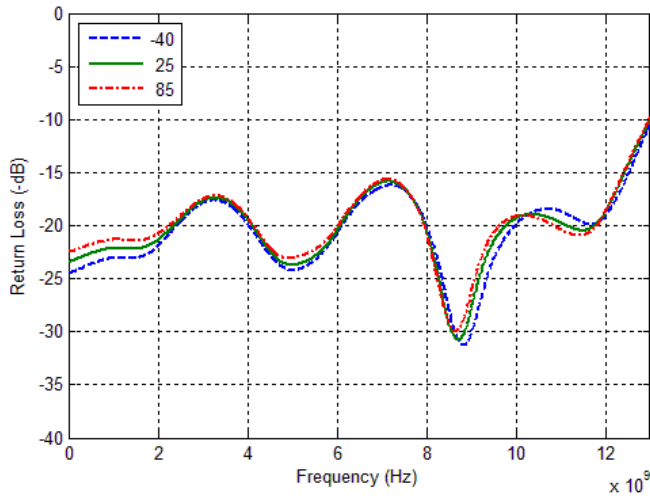

Figure 9. Insertion Loss vs.  $V_{DD}$  (RFC–RF2)



Typical Performance Data @ +25 °C and  $V_{DD} = 3.4V$ , unless otherwise specified (Cont.)

**Figure 10. RFC Port Return Loss vs. Temp (RF1 Active)**



**Figure 11. RFC Port Return Loss vs.  $V_{DD}$  (RF1 Active)**

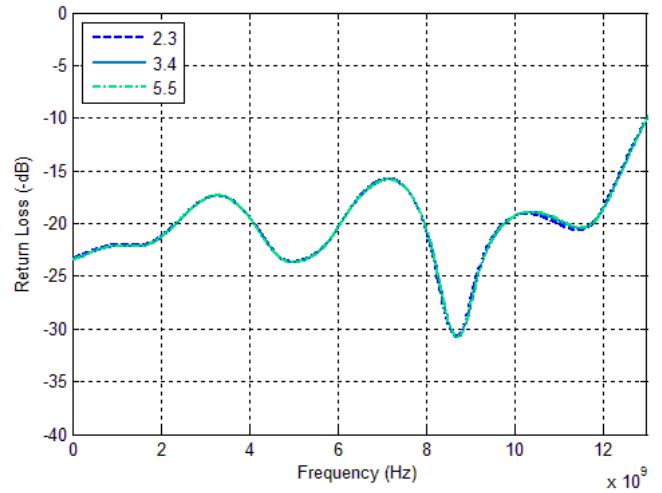

**Figure 12. RFC Port Return Loss vs. Temp (RF2 Active)**

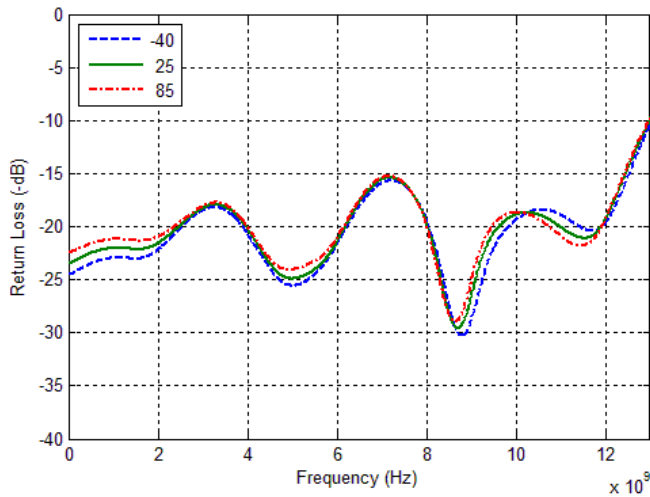

**Figure 13. RFC Port Return Loss vs.  $V_{DD}$  (RF2 Active)**

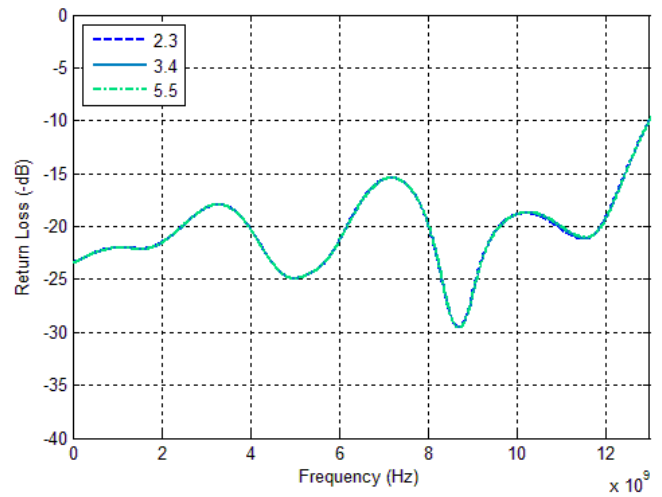

Typical Performance Data @ +25 °C and  $V_{DD} = 3.4V$ , unless otherwise specified (Cont.)

Figure 14. Active Port Return Loss vs. Temp (RF1 Active)

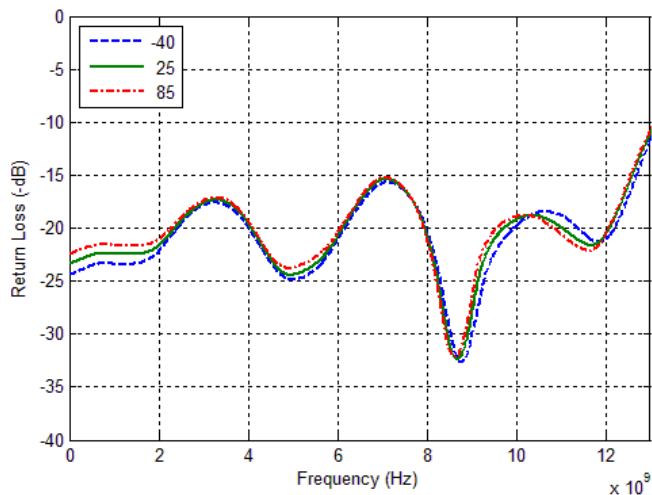

Figure 15. Active Port Return Loss vs.  $V_{DD}$  (RF1 Active)

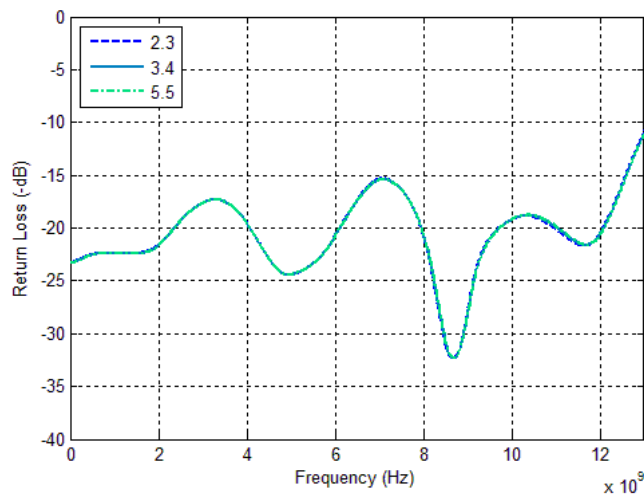

Figure 16. Active Port Return Loss vs. Temp (RF2 Active)

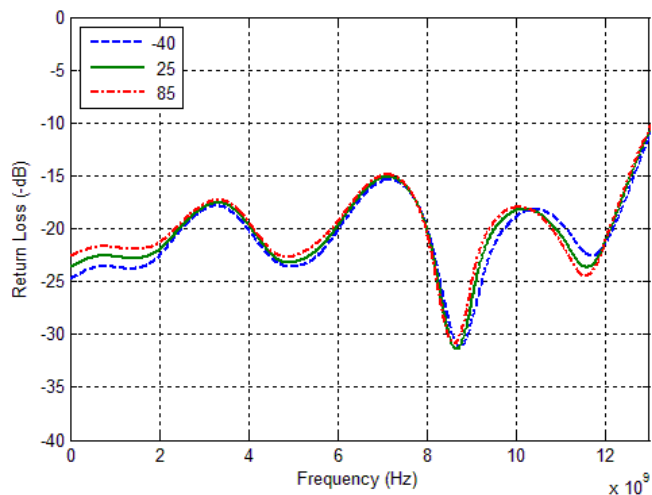
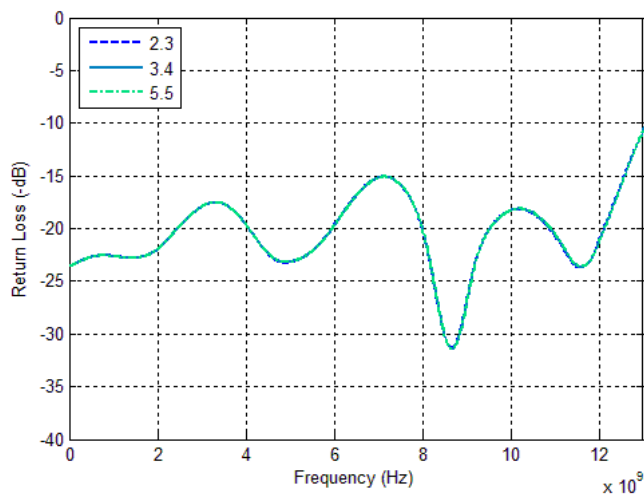

Figure 17. Active Port Return Loss vs.  $V_{DD}$  (RF2 Active)



Typical Performance Data @ +25 °C and  $V_{DD} = 3.4V$ , unless otherwise specified (Cont.)

Figure 18. Terminated Port Return Loss vs. Temp (RF1 Active)

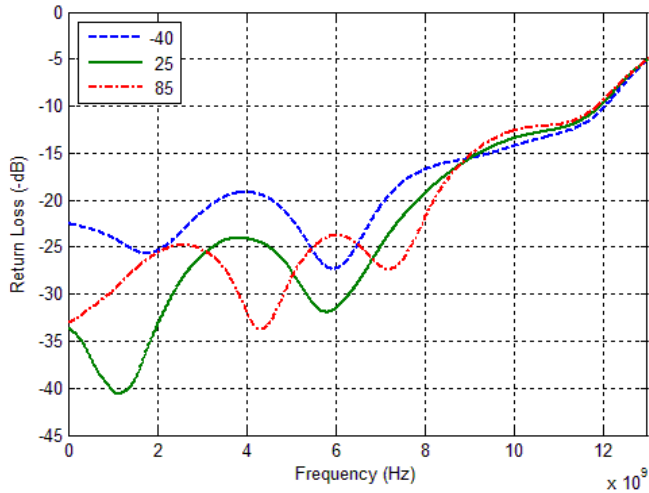

Figure 19. Terminated Port Return Loss vs.  $V_{DD}$  (RF1 Active)

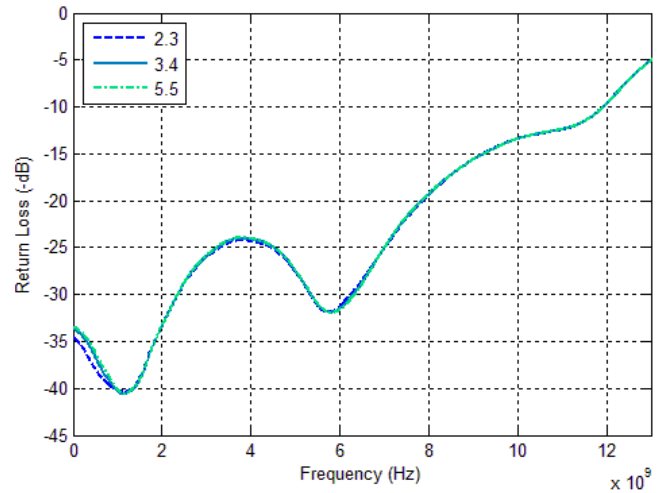

Figure 20. Terminated Port Return Loss vs. Temp (RF2 Active)

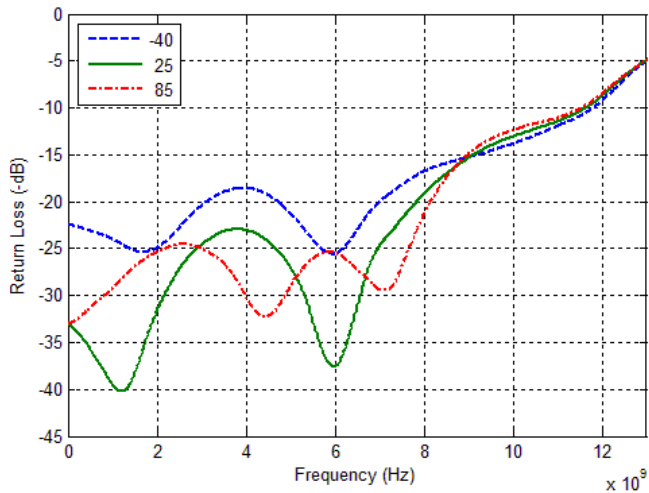
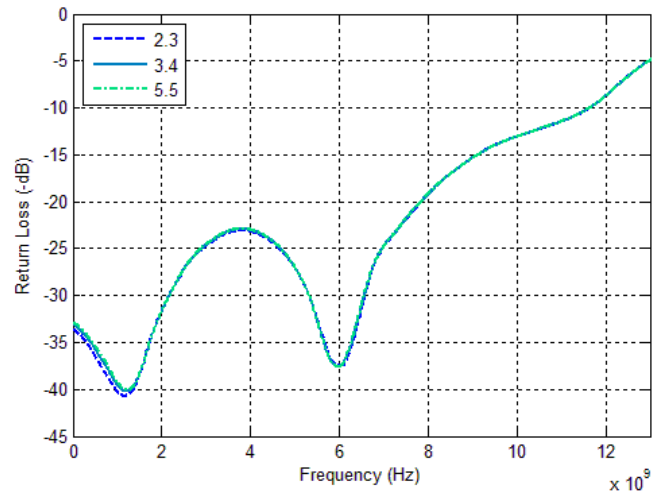

Figure 21. Terminated Port Return Loss vs.  $V_{DD}$  (RF2 Active)



Typical Performance Data @ +25 °C and  $V_{DD} = 3.4V$ , unless otherwise specified (Cont.)

Figure 22. Isolation vs. Temp  
(RF1–RF2, RF1 Active)

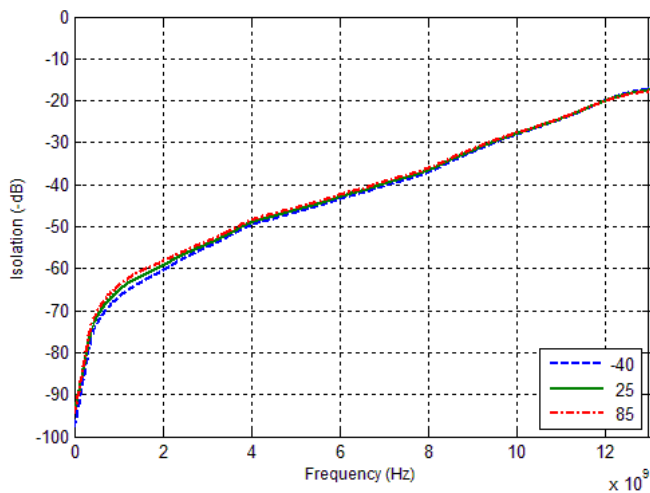

Figure 23. Isolation vs.  $V_{DD}$   
(RF1–RF2, RF1 Active)

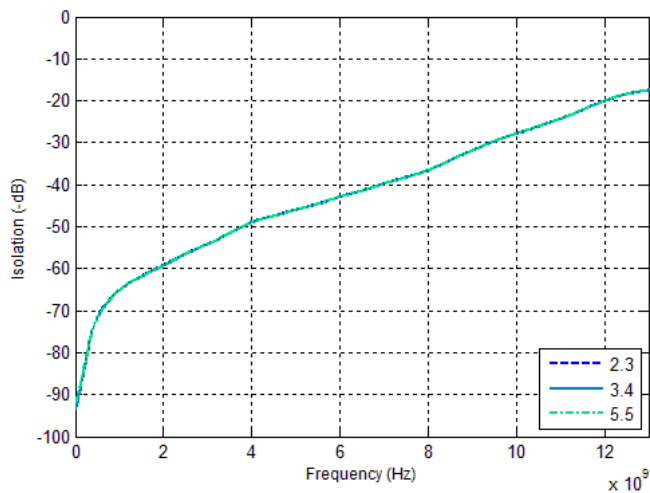

Figure 24. Isolation vs. Temp  
(RF2–RF1, RF2 Active)

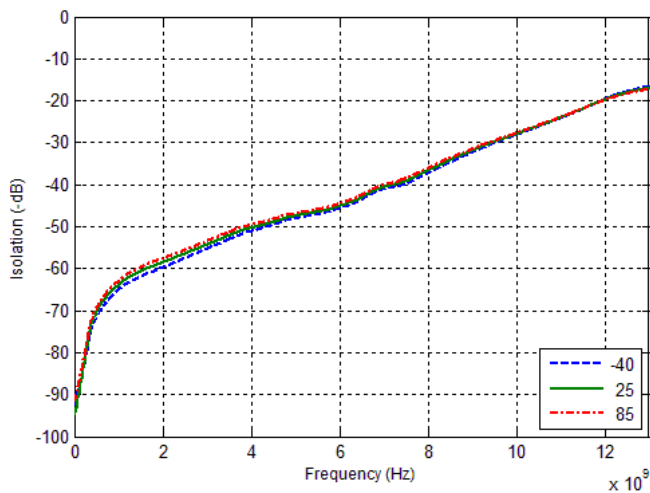
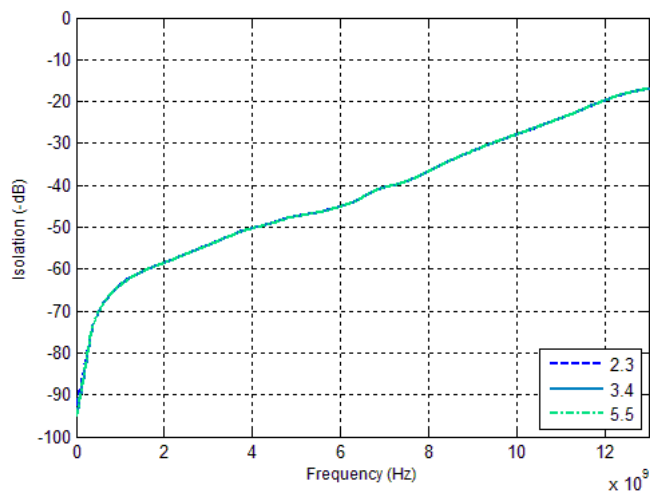

Figure 25. Isolation vs.  $V_{DD}$   
(RF2–RF1, RF2 Active)



Typical Performance Data @ +25 °C and  $V_{DD} = 3.4V$ , unless otherwise specified (Cont.)

Figure 26. Isolation vs. Temp  
(RFC–RF2, RF1 Active)

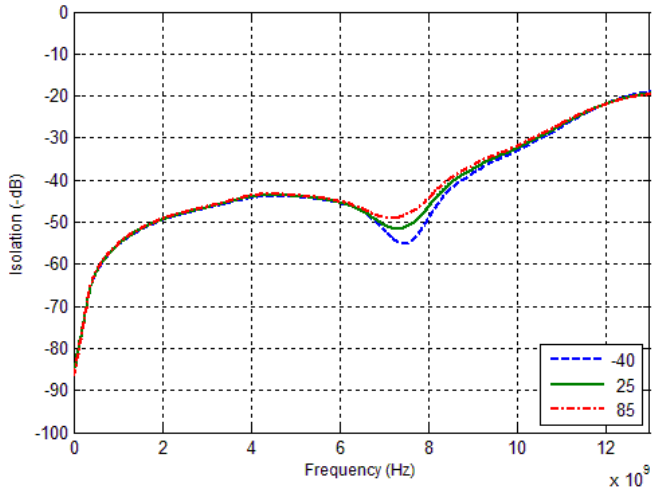

Figure 27. Isolation vs.  $V_{DD}$   
(RFC–RF2, RF1 Active)

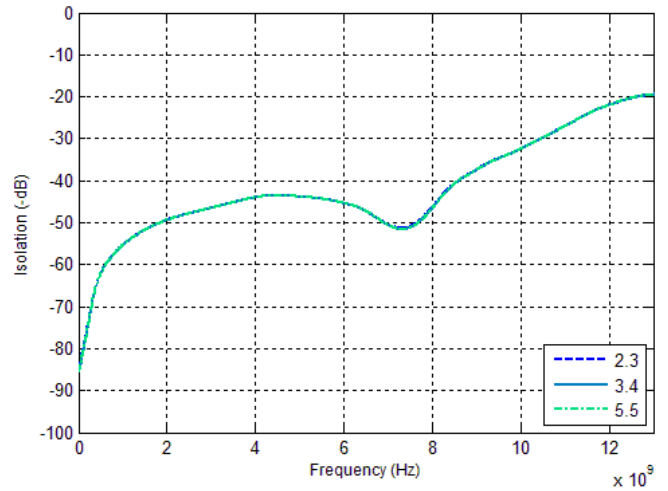

Figure 28. Isolation vs. Temp  
(RFC–RF1, RF2 Active)

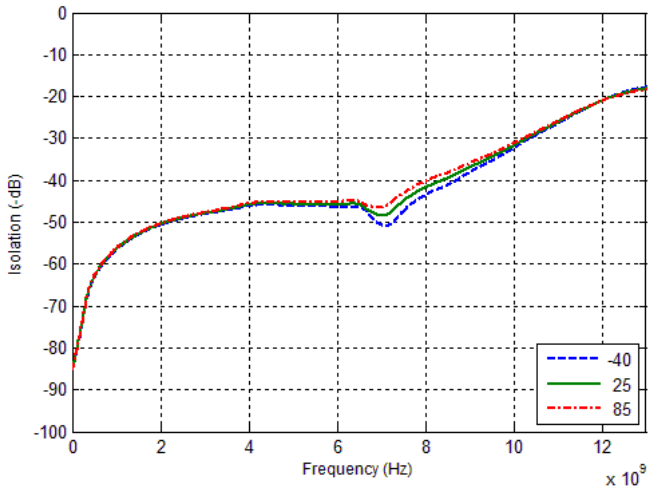
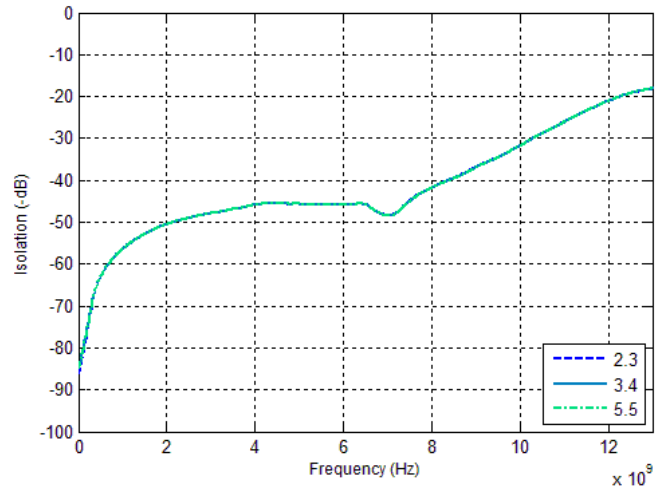

Figure 29. Isolation vs.  $V_{DD}$   
(RFC–RF1, RF2 Active)



### Evaluation Kit

The SPDT switch evaluation board was designed to ease customer evaluation of pSemi’s PE42520. The RF common port is connected through a 50Ω transmission line via the SMA connector, J1. RF1 and RF2 ports are connected through 50Ω transmission lines via SMA connectors J2 and J3, respectively. A 50Ω through transmission line is available via SMA connectors J5 and J6, which can be used to de-embed the loss of the PCB. J4 provides DC and digital inputs to the device.

For the true performance of the PE42520 to be realized, the PCB should be designed in such a way that RF transmission lines and sensitive DC I/O traces are heavily isolated from one another.

**Figure 30. Evaluation Kit Layout**

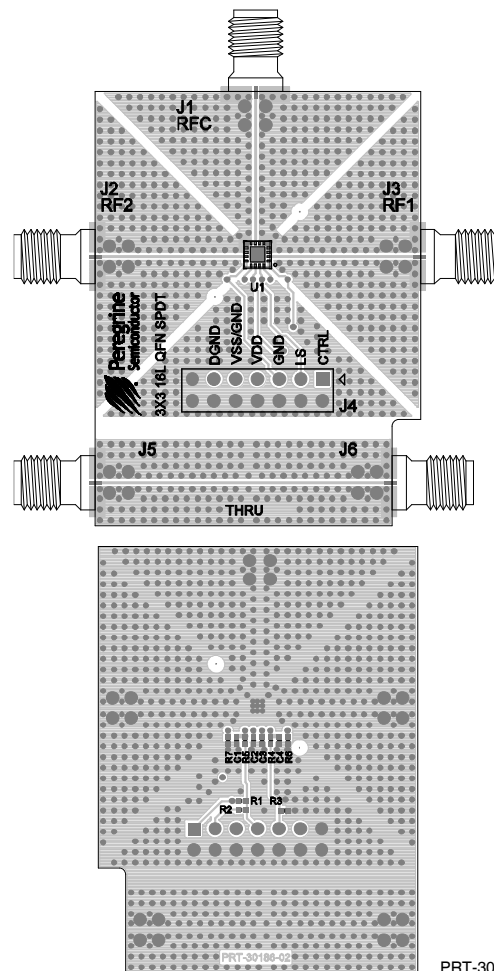

PRT-30186

**Figure 31. Evaluation Board Schematic**

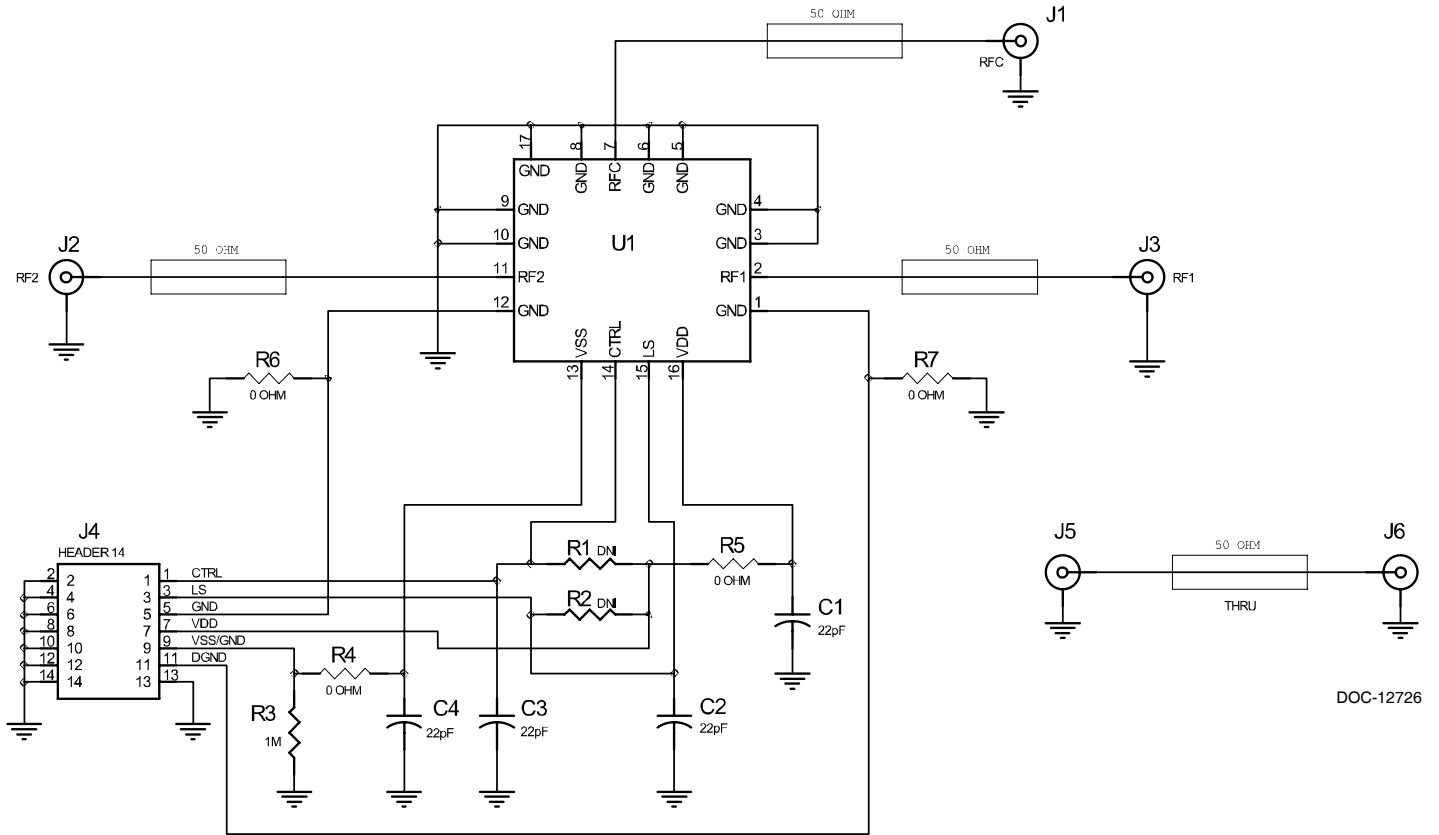

- Notes: 1. Use PRT-30186-02 PCB.  
2. CAUTION: Contains parts and assemblies susceptible to damage by electrostatic discharge (ESD).

Figure 32. Package Drawing

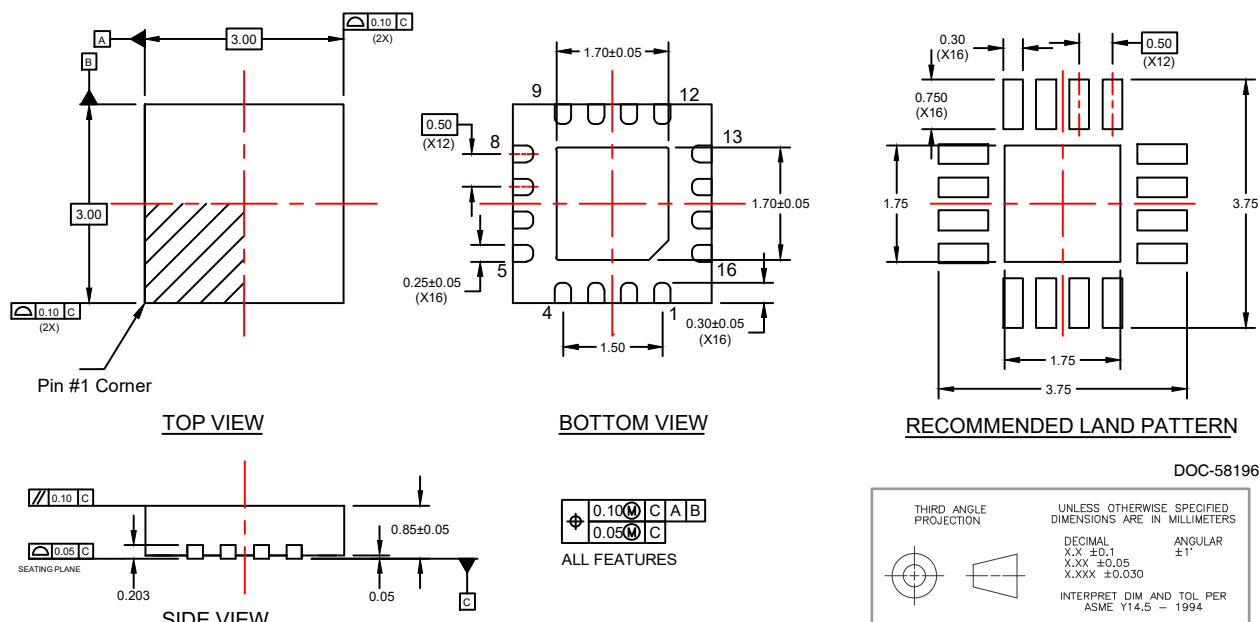
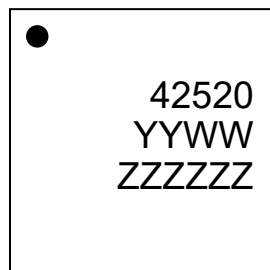

Figure 33. Top Marking Specifications



DOC-66052

- = Pin 1 designator
- YY = Last two digits of assembly year
- WW = Assembly work week
- ZZZZZ = Assembly lot code (maximum six characters)

**Figure 34. Tape and Reel Specifications**

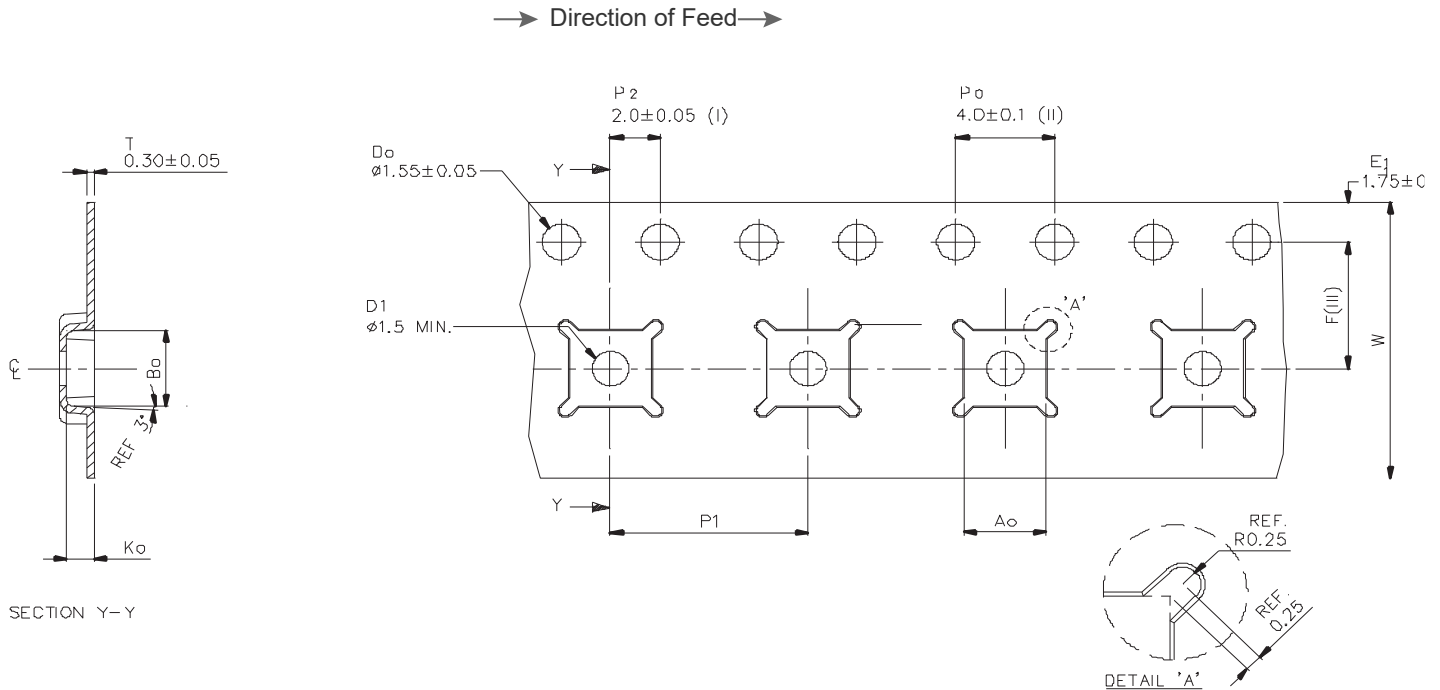

|    |             |
|----|-------------|
| Ao | 3.30 ± 0.1  |
| Bo | 3.30 ± 0.1  |
| Ko | 1.10 ± 0.1  |
| F  | 5.50 ± 0.05 |
| P1 | 8.00 ± 0.1  |
| W  | 12.00 ± 0.3 |

**Notes:**

1. Measured from centerline of sprocket hole to centerline of pocket.
2. Cumulative tolerance of 10 sprocket holes ± 0.20.
3. Measured from centerline of sprocket hole to centerline of sprocket.

Dimensions are in millimeters unless otherwise specified.

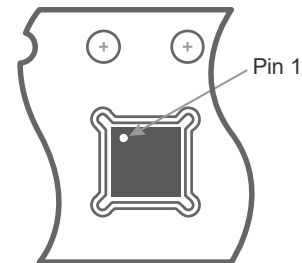

Device Orientation in Tape

**Table 7. Ordering Information**

| Order Code | Description            | Package                    | Shipping Method  |
|------------|------------------------|----------------------------|------------------|
| PE42520C-Z | PE42520 SPDT RF switch | Green 16-lead 3 × 3 mm QFN | 3000 units / T&R |
| EK42520-03 | PE42520 Evaluation kit | Evaluation kit             | 1 / Box          |

**Sales Contact and Information**

For sales and contact information please visit [www.psemi.com](http://www.psemi.com).

**Advance Information:** The product is in a formative or design stage. The datasheet contains design target specifications for product development. Specifications and features may change in any manner without notice.  
**Preliminary Specification:** The datasheet contains preliminary data. Additional data may be added at a later date. pSemi reserves the right to change specifications at any time without notice in order to supply the best possible product.  
**Product Specification:** The datasheet contains final data. In the event pSemi decides to change the specifications, pSemi will notify customers of the intended changes by issuing a CNF (Customer Notification Form).  
 The information in this document is believed to be reliable. However, pSemi assumes no liability for the use of this information. Use shall be entirely at the user's own risk.

No patent rights or licenses to any circuits described in this document are implied or granted to any third party. pSemi's products are not designed or intended for use in devices or systems intended for surgical implant, or in other applications intended to support or sustain life, or in any application in which the failure of the pSemi product could create a situation in which personal injury or death might occur. pSemi assumes no liability for damages, including consequential or incidental damages, arising out of the use of its products in such applications.  
 The Peregrine Semiconductor name, Peregrine Semiconductor logo and UltraCMOS are registered trademarks and the pSemi name, pSemi logo, HaRP and DuNE are trademarks of pSemi Corporation in the U.S. and other countries.  
 pSemi products are protected under one or more of the following U.S. patents: [patents.psemi.com](http://patents.psemi.com).

## Looking for pricing, stock, or lifecycle information?

Click below to explore more details on WIN SOURCE:

 [View EK42520-03 on WIN SOURCE](#)

 [pSemi Information](#)

## Optimize Your Supply Chain with WIN SOURCE Solutions

-  Global Sourcing Solution
-  Obsolete Management
-  Cost Control Management
-  Shortage Management
-  Alternative Solution
-  Excess Inventory Management