



**THE DATASHEET OF
MMB21-0341QU**





Rack and Panel Connectors Military, MIL-C-28748/7/8 Qualified and Commercial Microminiature Rectangular



FEATURES

- Qualified to MIL-C-28748/7/8
- Solder cup contacts
- Dip solder contacts
- Fixed and turnable screwlocks
- Optional closed entry socket contacts

APPLICATIONS

Especially suited for use in airborne, instrumentation and portable equipment applications or wherever the following requirements must be met: Minimum space and weight without sacrifice of performance, high quality materials, long service life, high vibration and shock resistance and positive locking.

ELECTRICAL SPECIFICATIONS

Current Rating: Model MM22 = 5 A

Model MM24 = 3 A

Breakdown Voltage: At sea level: 2000 V_{RMS}

At 70 000 feet: 500 V_{RMS}

MATERIAL SPECIFICATIONS

Contact Pin: Phosphor bronze

Contact Socket: Phosphor bronze (Beryllium copper available on request)

Contact Plating: Gold

Screwlocks: Stainless steel, passivated

Guides: Brass, gold plated or stainless steel, passivated

Standard Body: Glass-filled diallyl phthalate per MIL-M-14, Model SDG-F, green

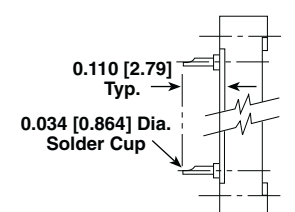
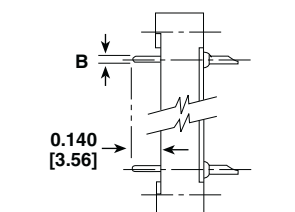
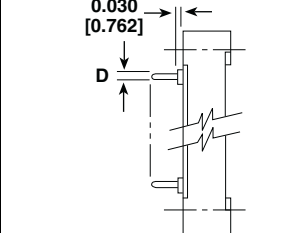
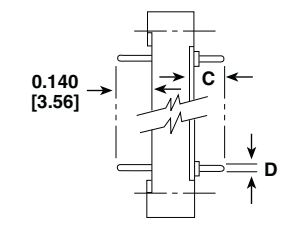
DIMENSIONS in inches [millimeters]					
MMS With Solder Cup Contacts 		MMP With Solder Cup Contacts 		MMDS With Dip Solder Contacts 	MMDP With Dip Solder Contacts 
CONTACT GAUGE	B DIAMETER	CONTACT GAUGE	C DIP TAIL LENGTH	D DIAMETER	
22 AWG	0.030 ± 0.001 [0.762 ± 0.025]	22 AWG	0.160 or 0.350 [4.06 or 8.89] nom.	0.025 [0.635]	
24 AWG	0.025 ± 0.001 [0.635 ± 0.025]	24 AWG	0.160 or 0.350 [4.06 or 8.89] nom.	0.025 [0.635]	

DIMENSIONS in inches [millimeters]				
		HARDWARE TYPE	E DIAMETER	F DIAMETER
<p>MMS With Fixed (026, 027) Guides</p> <p>0.520 [13.21] 0.230 [5.84] 2-56 UNC-2A Thread Typ. 0.140 [3.56] 0.030 [0.762] Wide x 0.040 [1.02] Deep Slot Typ. 0.110 [2.79] 0.034 [0.864] Dia. Solder Cup #22 or #24 AWG Max. F Dia.</p>	<p>MMP With Fixed (026, 027) Guides</p> <p>0.490 [12.45] 0.230 [5.84] "A" End of Connector 0.140 [3.56] E Dia.</p>	026	0.078 [1.98]	0.125 [3.17]
		026L	0.078 [1.98]	0.125 [3.17]
		027	0.078 [1.98]	0.125 [3.17]
		027L	0.078 [1.98]	0.125 [3.17]
<p>MMS With Fixed (026L, 027L) Guides</p> <p>0.620 [15.75] 0.230 [5.84] 0.140 [3.56] 0.040 [1.02] Typ. 0.034 [0.864] Dia. Solder Cup #22 or #24 AWG Max. 0.030 [0.762] Typ. 0.110 [2.79]</p>	<p>MMP With Fixed (026L, 027L) Guides</p> <p>"A" End of Connector 0.590 [14.99] 0.250 [6.35] 2-56 UNC-2A Typ.</p>	<p>Short Turnable Screwlocks (SK030)</p> <p>0.540 [13.72] 0.160 [4.06] 0.030 [0.762] Wide x 0.040 [1.02] Deep Typ. 0.124 [3.15] Dia. 0.110 [2.79] 0.500 [12.70]</p>		<p>Turnable Screwlocks (SK)</p> <p>0.950 [24.13] 0.046 [1.17] Wide x 0.062 [1.57] Deep Typ. 0.187 [4.75] Dia. 0.110 [2.79] 0.910 [23.11]</p>
<p>Fixed Screwlocks (SL)</p> <p>0.490 [12.45] 0.140 [3.56] 0.520 [13.21]</p>	<p>Fixed Screwlocks (SLL)</p> <p>0.620 [15.75] 0.230 [5.84] 0.140 [3.56] 0.034 [0.864] Dia. Solder Cup #22 or #24 AWG Max. 0.250 [6.35] 0.590 [14.99] 0.110 [2.79]</p>	<p>Fixed Screwlocks And Nylon Retaining Nut And Fiber Washer (NSL)</p> <p>0.590 [14.99] 0.620 [15.75]</p>		<p>Short Turnable Screwlocks (SK2035)</p> <p>0.610 [15.49] 0.240 [6.10] Typ. 0.093 [2.36] Hex Socket 0.090 [2.29] Deep Typ. 0.180 [4.57] Dia. 0.110 [2.79] 0.580 [14.73]</p>

HARDWARE MATING CHART		<p>NOTE: EITHER MMP OR MMS CONNECTORS MAY BE ORDERED WITH ANY TYPE OF HARDWARE SHOWN.</p> <p>EXAMPLES:</p> <ol style="list-style-type: none"> 1. MMP WITH 026 HARDWARE WOULD MATE WITH AN MMS WITH 026 HARDWARE. 2. MMS WITH SK HARDWARE WOULD MATE WITH AN MMP WITH SL OR NSL HARDWARE. 3. MMS WITH SL2 HARDWARE WOULD MATE WITH AN MMP WITH SK2 OR SK2030 HARDWARE.
HARDWARE MODEL	MATES WITH HARDWARE MODEL	
026	026, 026L	
027	027, 027L	
SK	SL, NSL or SLL	
SK030	SL, NSL or SLL	
SK2	SL2, NSL2 or SL2L	
SK2030	SL2, NSL2 or SL2L	
SK2035	SL2, NSL2 or SL2L	

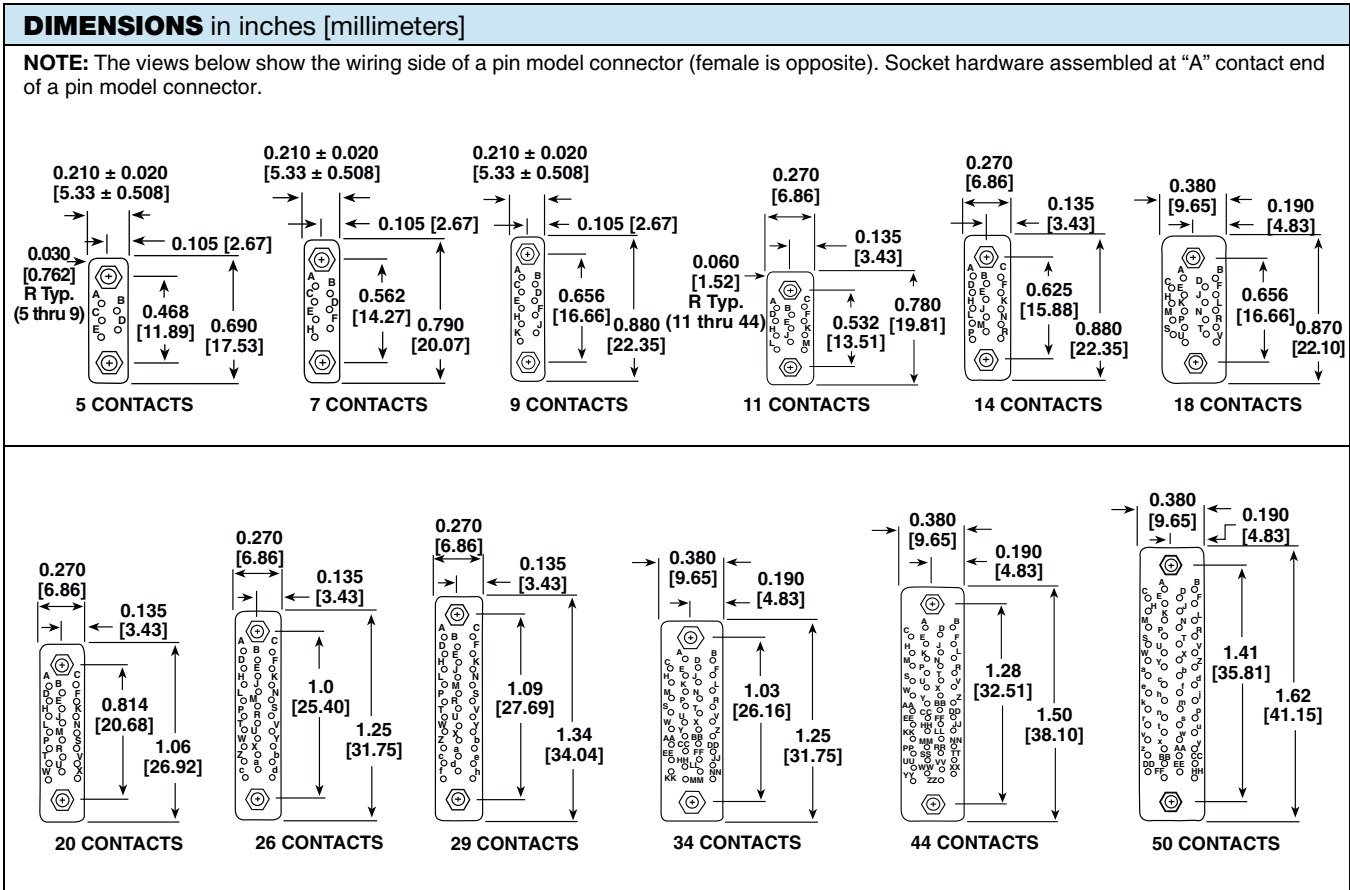



MOUNTING VARIATIONS in inches [millimeters]

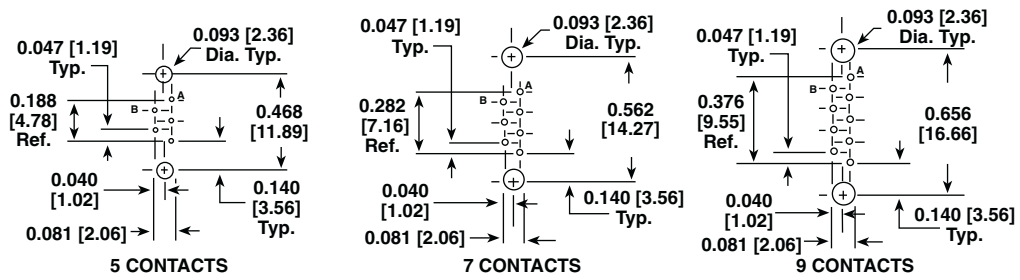

DIP SOLDER PC BOARD MOUNTING PATTERNS
 Male (MMP) connector shown - female is opposite.
 Contact, contact row and mating hole C_L to C_L
 Dimensions also applies to solder cup style connectors.

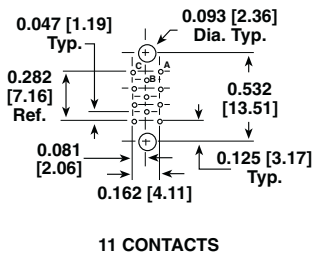

11 CONTACTS

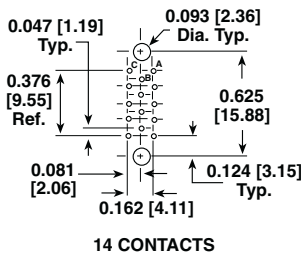

14 CONTACTS

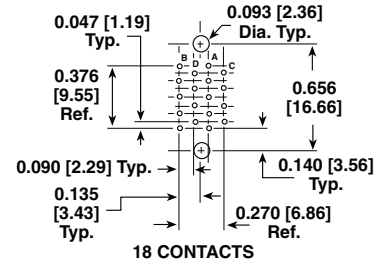

18 CONTACTS

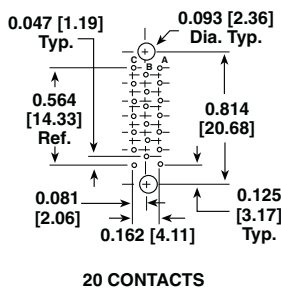

20 CONTACTS

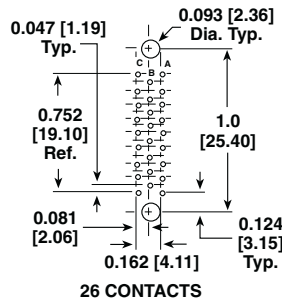

26 CONTACTS

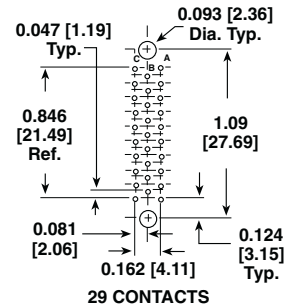

29 CONTACTS

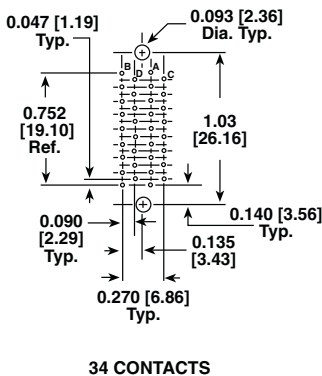

34 CONTACTS

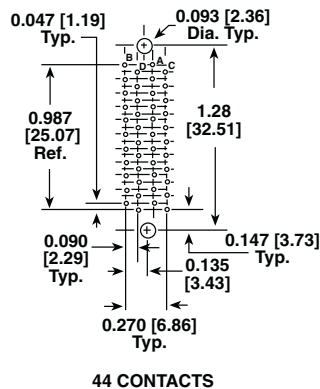

44 CONTACTS

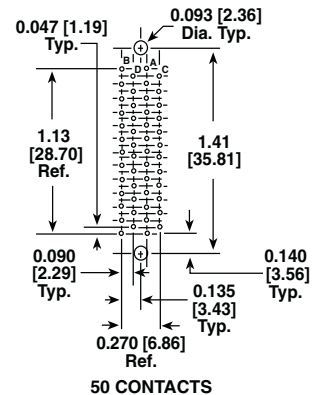

50 CONTACTS

PANEL CUTOUT in inches [millimeters]								
	NUMBER OF CONTACTS	A	B	C	NUMBER OF CONTACTS	A	B	C
	5	0.210 [5.33]	0.468 [11.89]	0.340 [8.64]	20	0.270 [6.86]	0.814 [20.68]	0.690 [17.53]
	7	0.210 [5.33]	0.562 [14.27]	0.440 [11.18]	26	0.270 [6.86]	1.0 [25.40]	0.870 [22.10]
	9	0.210 [5.33]	0.656 [16.66]	0.530 [13.46]	29	0.270 [6.86]	1.09 [27.69]	0.970 [24.64]
	11	0.270 [6.86]	0.532 [13.51]	0.410 [10.41]	34	0.380 [9.65]	1.03 [26.16]	0.910 [23.11]
	14	0.270 [6.86]	0.625 [15.88]	0.500 [12.70]	44	0.380 [9.65]	1.28 [32.51]	1.16 [29.46]
	18	0.380 [9.65]	0.656 [16.66]	0.530 [13.46]	50	0.380 [9.65]	1.41 [35.81]	1.28 [32.51]

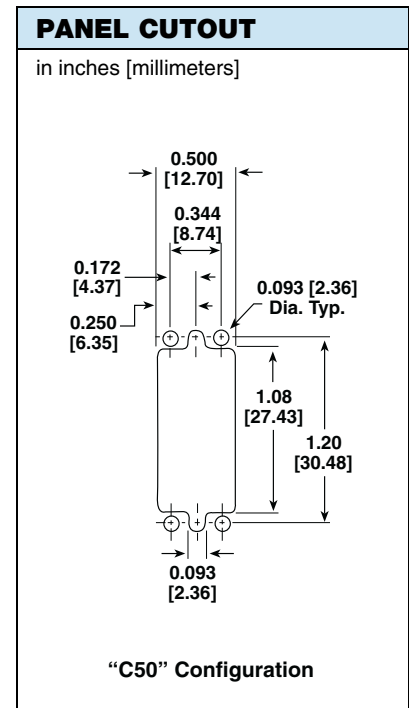
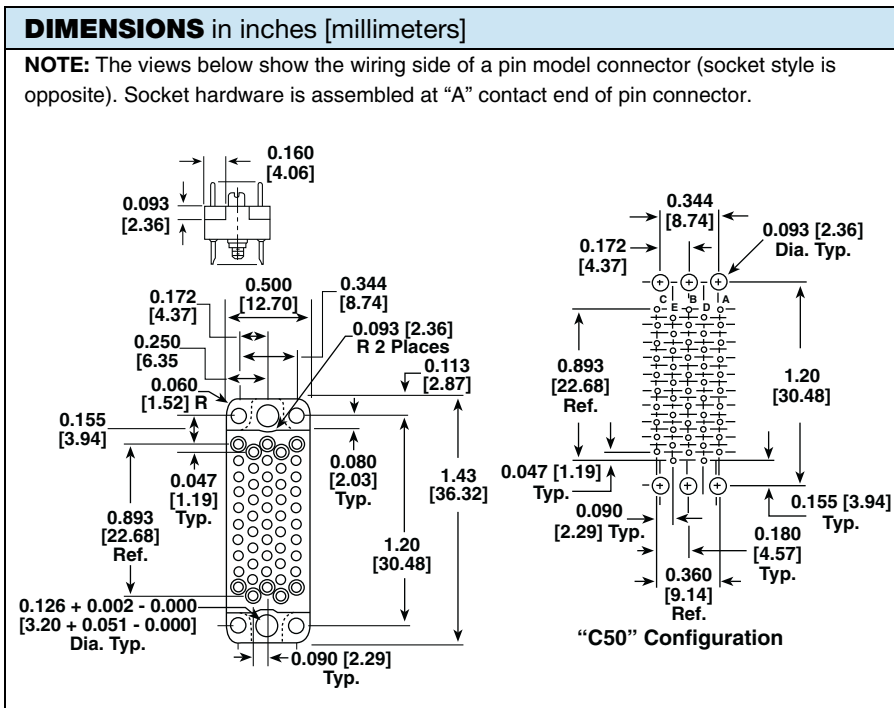

DIP SOLDER PC BOARD MOUNTING PATTERNS

Male (MMP) connector shown - female is opposite. Contact, contact row and mating hole C_L to C_L dimensions also applies to solder cup style connectors.



ORDERING INFORMATION

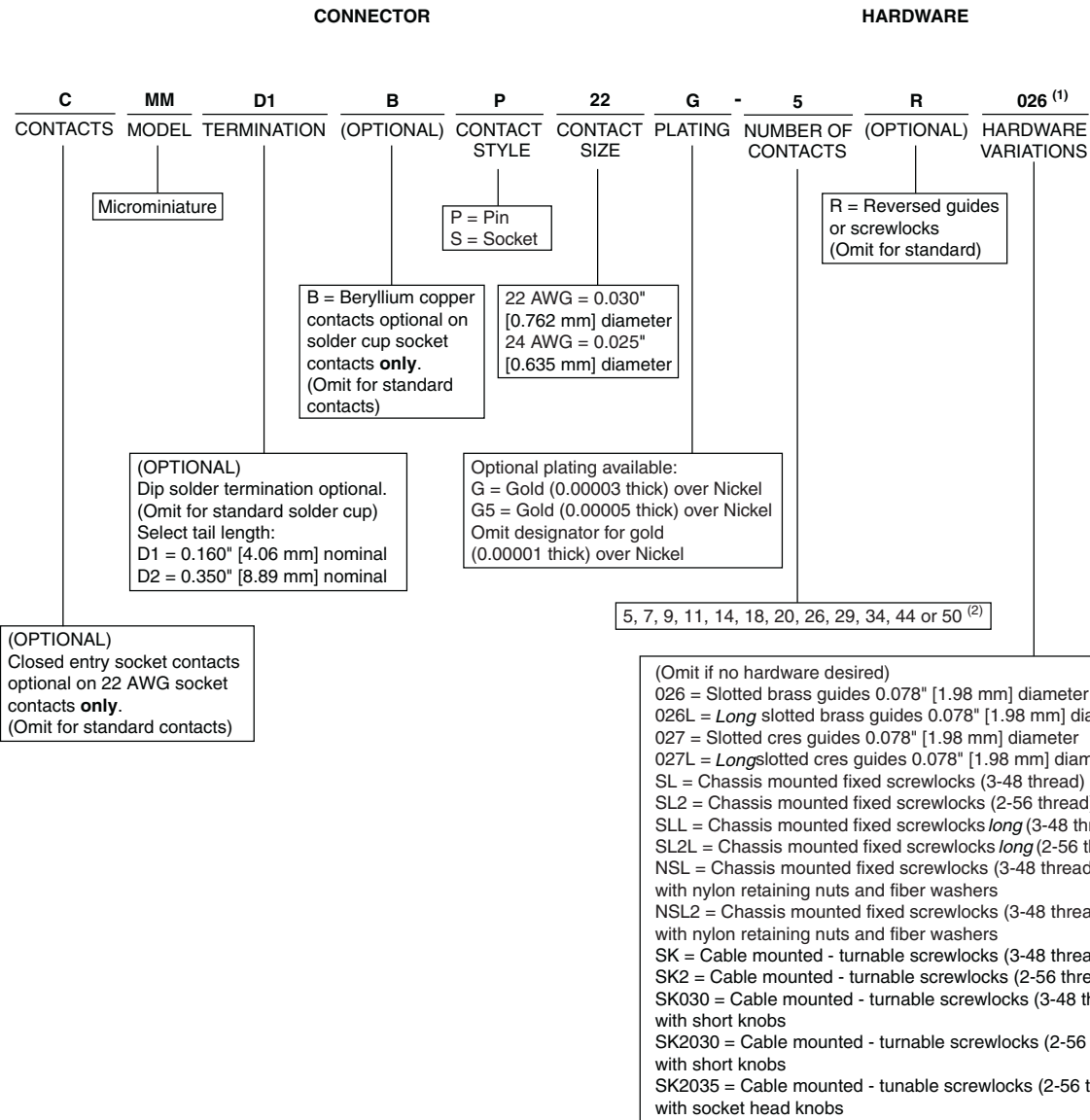

Notes

- (1) To order complete connector with hardware supplied unassembled, add suffix "UA" on end of hardware designation.
- (2) 50 contact connectors are available in either the standard 4-row contact arrangement per MIL-C-28748 or a special 5-row contact arrangement. To order the special 5-row contact arrangement, use the designator "C50" for the number of contacts.



Disclaimer

ALL PRODUCT, PRODUCT SPECIFICATIONS AND DATA ARE SUBJECT TO CHANGE WITHOUT NOTICE TO IMPROVE RELIABILITY, FUNCTION OR DESIGN OR OTHERWISE.

Vishay Intertechnology, Inc., its affiliates, agents, and employees, and all persons acting on its or their behalf (collectively, "Vishay"), disclaim any and all liability for any errors, inaccuracies or incompleteness contained in any datasheet or in any other disclosure relating to any product.

Vishay makes no warranty, representation or guarantee regarding the suitability of the products for any particular purpose or the continuing production of any product. To the maximum extent permitted by applicable law, Vishay disclaims (i) any and all liability arising out of the application or use of any product, (ii) any and all liability, including without limitation special, consequential or incidental damages, and (iii) any and all implied warranties, including warranties of fitness for particular purpose, non-infringement and merchantability.

Statements regarding the suitability of products for certain types of applications are based on Vishay's knowledge of typical requirements that are often placed on Vishay products in generic applications. Such statements are not binding statements about the suitability of products for a particular application. It is the customer's responsibility to validate that a particular product with the properties described in the product specification is suitable for use in a particular application. Parameters provided in datasheets and / or specifications may vary in different applications and performance may vary over time. All operating parameters, including typical parameters, must be validated for each customer application by the customer's technical experts. Product specifications do not expand or otherwise modify Vishay's terms and conditions of purchase, including but not limited to the warranty expressed therein.

Hyperlinks included in this datasheet may direct users to third-party websites. These links are provided as a convenience and for informational purposes only. Inclusion of these hyperlinks does not constitute an endorsement or an approval by Vishay of any of the products, services or opinions of the corporation, organization or individual associated with the third-party website. Vishay disclaims any and all liability and bears no responsibility for the accuracy, legality or content of the third-party website or for that of subsequent links.

Except as expressly indicated in writing, Vishay products are not designed for use in medical, life-saving, or life-sustaining applications or for any other application in which the failure of the Vishay product could result in personal injury or death. Customers using or selling Vishay products not expressly indicated for use in such applications do so at their own risk. Please contact authorized Vishay personnel to obtain written terms and conditions regarding products designed for such applications.

No license, express or implied, by estoppel or otherwise, to any intellectual property rights is granted by this document or by any conduct of Vishay. Product names and markings noted herein may be trademarks of their respective owners.

Looking for pricing, stock, or lifecycle information?

Click below to explore more details on WIN SOURCE:

 [View MMB21-0341QU on WIN SOURCE](#)

 [Vishay Information](#)

Optimize Your Supply Chain with WIN SOURCE Solutions

-  Global Sourcing Solution
-  Obsolete Management
-  Cost Control Management
-  Shortage Management
-  Alternative Solution
-  Excess Inventory Management