



**THE DATASHEET OF
MS3111E8-4P**



NEW

PT Series Sealed Power Toggle Switch

Features/Benefits

- **IP66/IP68 versatile rating to withstand harsh outdoor environments, intense, wet weather, wind blown rain, dirt**
- **UL 61058-1 certified has global acceptance with no additional testing needed**
- **Integrated panel seal for extra protection**
- **Superior oil and fuel resistance**
- **High strength, heat resistant housing designed for demanding applications subject to vibration and harsh conditions**

Typical Applications

- **Off-road, Construction/Agricultural vehicles**
- **Material handling equipment**
- **Articulating, scissor, and bucket lift controls**
- **Outdoor industrial equipment**
- **Lift gate controls**



Specifications

UL ELECTRICAL RATINGS:	UL 61058-1
MAINTAINED FUNCTIONS:	15A GP, 277VAC 50/60Hz T85 15(4)A, 277VAC 50/60Hz T85 1/2 hp, 125VAC 50/60Hz T85 1 hp, 250VAC 50/60Hz T85
MOMENTARY FUNCTIONS:	10A GP, 277VAC 50/60Hz T85 10(4)A, 277VAC 50/60Hz T85 1/4hp, 125VAC 50/60Hz T85 1/2 hp, 250VAC 50/60Hz T85
ELECTRICAL LIFE:	10,000 cycles
DC ELECTRICAL RATINGS:	Resistive Loads
ALL FUNCTIONS:	Up to 25A, 24VDC 0.75A, 125VDC 0.5A, 250VDC
MAINTAINED FUNCTIONS:	15A, 28VDC
MOMENTARY FUNCTIONS:	10A, 28VDC
DIELECTRIC STRENGTH:	2500V min. initial (terminal to toggle)
INSULATION RESISTANCE:	1000 MΩ min. initial
CONTACT RESISTANCE:	50 mΩ max. initial(terminal to toggle)
OPERATING AND STORAGE TEMPERATURE:	-40°C to +85°C
IP RATINGS:	IP66/IP68 Versatile

Materials

CASE:	Thermoset
ACTUATOR:	Stainless Steel
PIVOT PIN:	Stainless Steel
BUSHING:	Zinc Die Cast
SEAL:	Silicone
MOVEABLE CONTACT(S):	Copper alloy, silver plated
BUTTON:	Silver Cadmium
TERMINALS:	Brass for Quick connect, silver plated brass for solder and screw terminals
HARDWARE:	Hex nut & locking ring: brass, nickel plated Screws: brass Lock washer: brass, nickel plated
PACKAGING:	Trays

Build-A-Switch

To order, simply select desired option from each category and place in the appropriate box. Available options are shown and described on pages F-53 thru F-56. For additional options not shown in catalog, consult Customer Service Center.

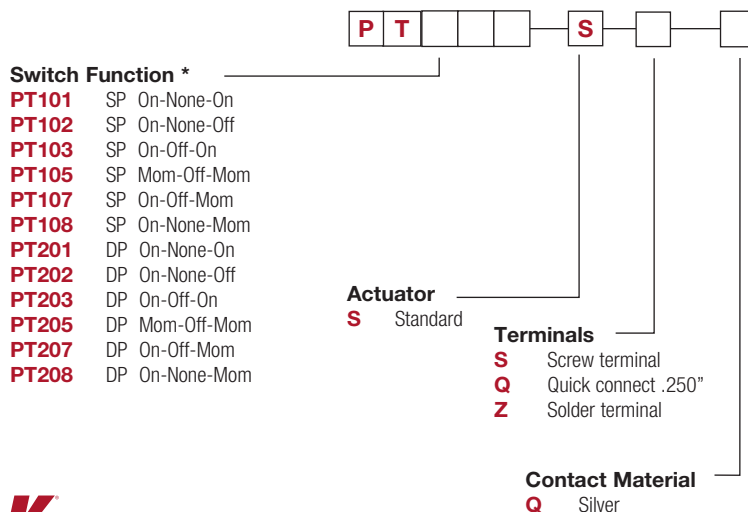

F

Toggle

PT Series Sealed Power Toggle Switch

NEW

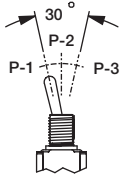
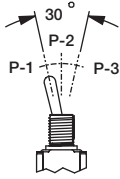
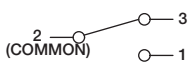

SP

	NO. POLES	MODEL NO.	SWITCH FUNCTION			CONNECTED TERMINALS			SCHEMATIC
			POS.1	POS.2	POS.3	POS.1	POS.2	POS.3	
	SP	PT101	ON	NONE	ON	2-3	N/A	2-1	
		PT102*	ON	NONE	OFF	2-3	N/A	OPEN	
		PT103	ON	OFF	ON	2-3	OPEN	2-1	
		PT105	MOM	OFF	MOM				
		PT107	ON	OFF	MOM				
		PT108	ON	NONE	MOM	2-3	N/A	2-1	

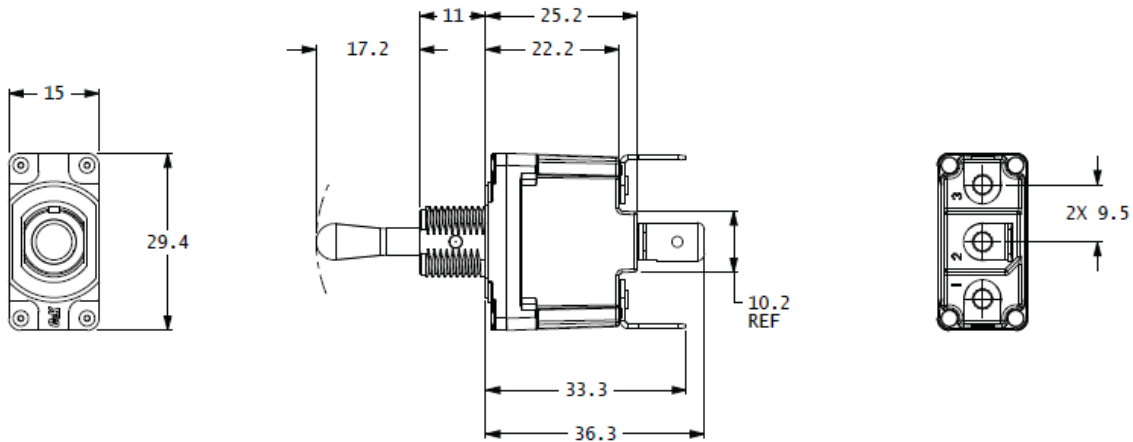
* PT102 OMIT TERMINAL 1

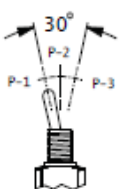
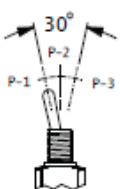

DP

	NO. POLES	MODEL NO.	SWITCH FUNCTION			CONNECTED TERMINALS			SCHEMATIC
			POS.1	POS.2	POS.3	POS.1	POS.2	POS.3	
	DP	PT201	ON	NONE	ON	2-3, 5-6	N/A	2-1, 4-5	
		PT202*	ON	NONE	OFF	2-3, 5-6	N/A	OPEN	
		PT203	ON	OFF	ON	2-3, 5-6	OPEN	2-1, 4-5	
		PT205	MOM	OFF	MOM				
		PT207	ON	OFF	MOM				
		PT208	ON	NONE	MOM	2-3, 5-6	N/A	2-1, 4-5	

* PT202 OMIT TERMINAL 1 AND 4

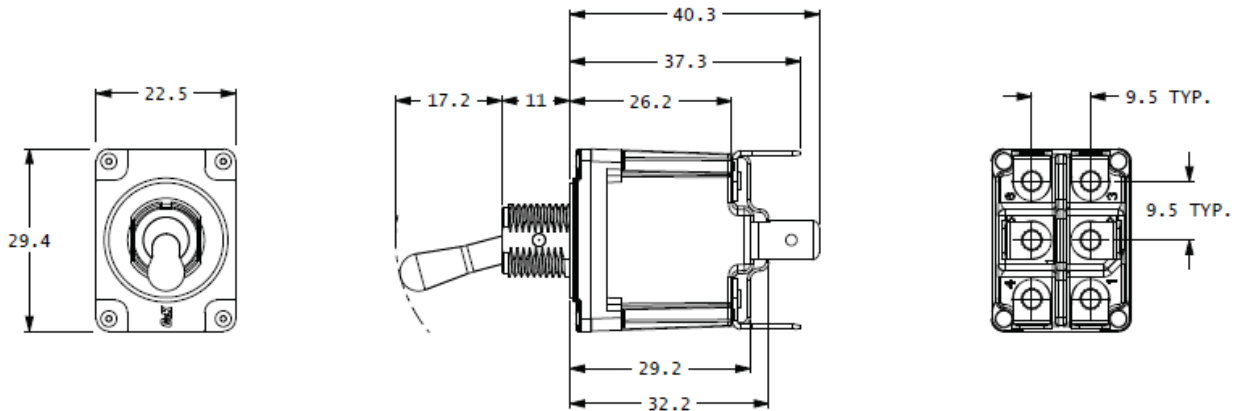

Toggle

NEW

PT Series Sealed Power Toggle Switch

ACTUATOR

S STANDARD

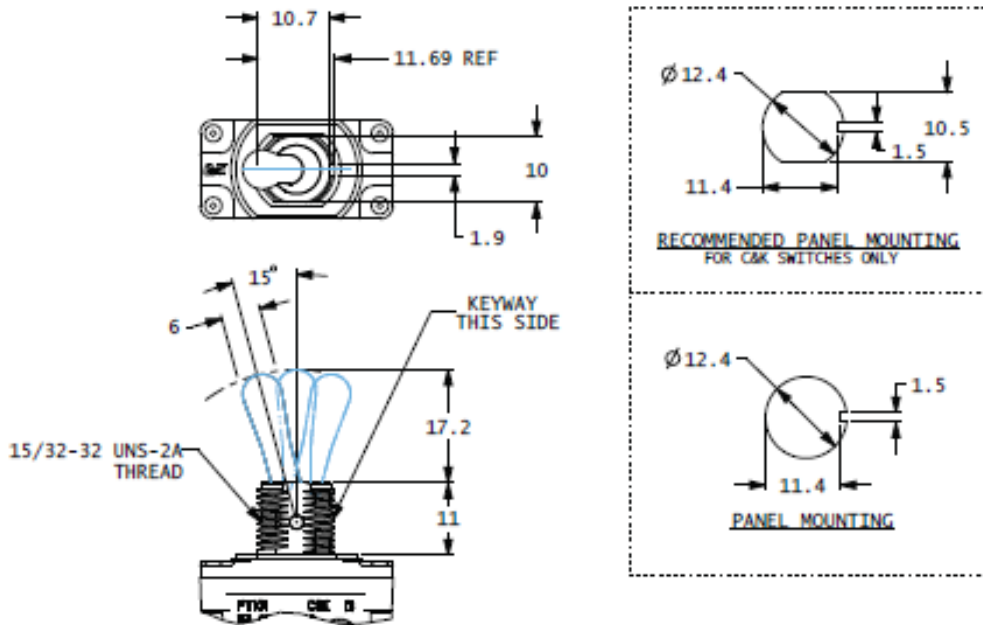

TERMINALS

S SCREW TERMINAL

Q QUICK CONNECT

SP

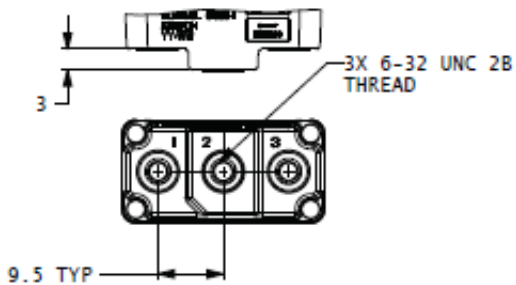

MODEL PT101SS SHOWN

SP

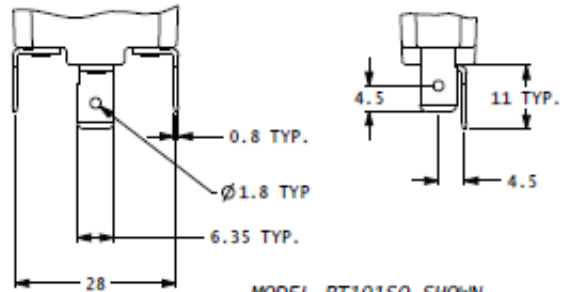

MODEL PT101SQ SHOWN

DP

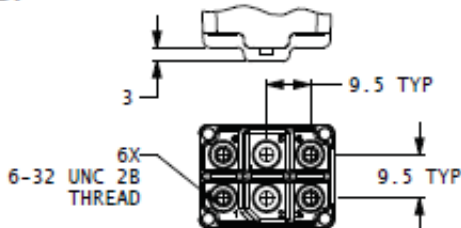

MODEL PT201SS SHOWN

DP

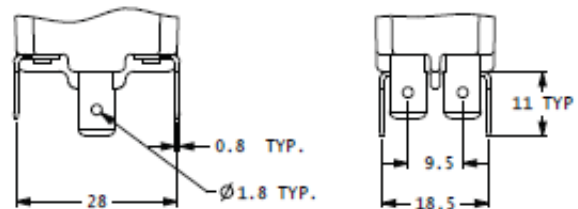

MODEL PT201SQ SHOWN



F

Toggle

PT Series Sealed Power Toggle Switches

NEW

Z SOLDER TERMINAL SP

SP

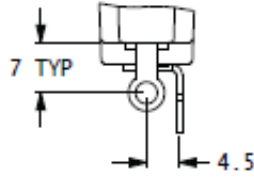
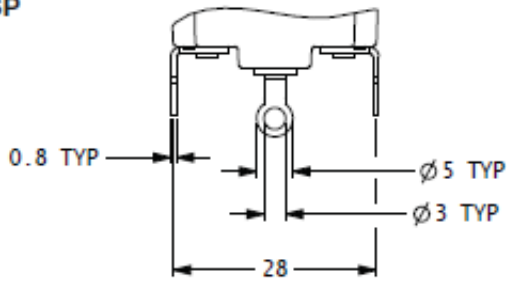

MODEL PT101SZ SHOWN

DP

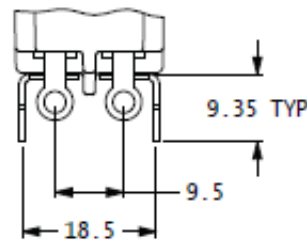
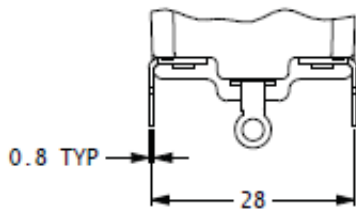

MODEL PT201SZ SHOWN

MOUNTING HARDWARE

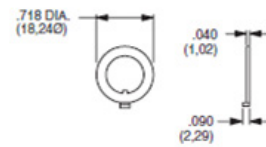
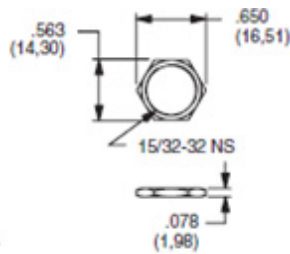
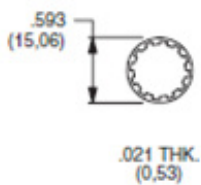

PART NO.
700302202 NICKEL PLATED

PART NO.
707100201 NICKEL PLATED

PART NO.
707200201 NICKEL PLATED WITH KEYWAY

Note: Standard hardware shipped with each switch is 1 pc each





T

Toggle

Looking for pricing, stock, or lifecycle information?

Click below to explore more details on WIN SOURCE:

-  [View MS3111E8-4P on WIN SOURCE](#)
-  [Amphenol Industrial Operations](#) Information

Optimize Your Supply Chain with WIN SOURCE Solutions

-  Global Sourcing Solution
-  Obsolete Management
-  Cost Control Management
-  Shortage Management
-  Alternative Solution
-  Excess Inventory Management