



**THE DATASHEET OF
MT3118-Y-A**





3Northway Lane North Latham, New York 12110.

Tollfree:1.800.984.5337

Phone:1.518.956.2980

Fax:1.518.785.4725

Http://www.marktechopto.com

SPECIFICATION

PART NO. : MT3118-Y-A

5.0mm ROUND LED LAMP



ATTENTION

**OBSERVE PRECAUTION
FOR HANDLING
ELECTRO STATIC
SENSITIVE
DEVICES**

Description

This yellow lamp is made with GaAsP/GaP chip and yellow diffused epoxy resin.

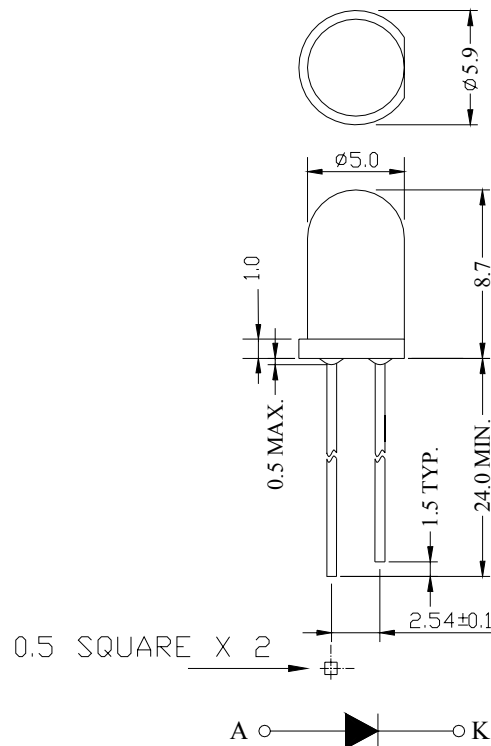

Notes:

- 1. ALL DIMENSIONS ARE IN mm.
- 2. TOLERANCE IS ±0.25mm UNLESS OTHERWISE NOTED.

Description

| Part No. | LED Chip | | Lens Color |
|------------|-----------|----------------|-----------------|
| | Material | Emitting Color | |
| MT3118-Y-A | GaAsP/GaP | Yellow | Yellow diffused |

Absolute Maximum Ratings at Ta=25

| Parameter | Symbol | Rating | Unit |
|---|----------|-------------|------|
| Power Dissipation | PD | 78 | mW |
| Reverse Voltage | VR | 5 | V |
| D.C. Forward Current | If | 30 | mA |
| Reverse (Leakage) Current | Ir | 100 | μA |
| Peak Current(1/10Duty Cycle,0.1ms Pulse Width.) | If(Peak) | 100 | mA |
| Operating Temperature Range | Topr. | -25 to +85 | |
| Storage Temperature Range | Tstg. | -40 to +100 | |
| Lead Soldering Temp.(1.6mm from body) for 5 seconds | | 260 | |
| | | | |

Electrical and Optical Characteristics:

| Parameter | Symbol | Condition | Min. | Typ. | Max. | Unit |
|---------------------------|--------|-----------|------|------|------|------|
| Luminous Intensity | Iv | If=20mA | 16.5 | 27.5 | | mcd |
| Forward Voltage | Vf | If=20mA | | 2.1 | 2.6 | V |
| Peak Wavelength | λP | If=20mA | | 585 | | nm |
| Dominant Wavelength | λD | If=20mA | | 590 | | nm |
| Reverse (Leakage) Current | Ir | VR=5V | | | 100 | μA |
| Viewing Angle | 2 1/2 | If=20mA | | 35 | | deg |
| Spectrum Line Halfwidth | Δλ | If=20mA | | 35 | | nm |

NOTE: THE DATAS TESTED BY IS TESTER

Typical Electrical / Optical Characteristics Curves :

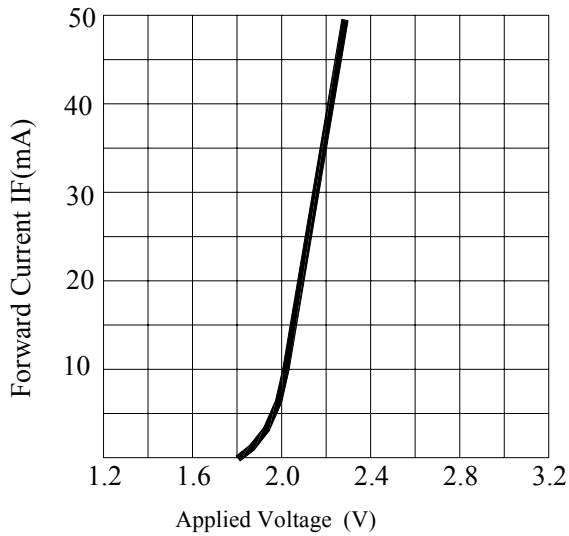

FORWARD CURRENT VS.APPLIED VOLTAGE

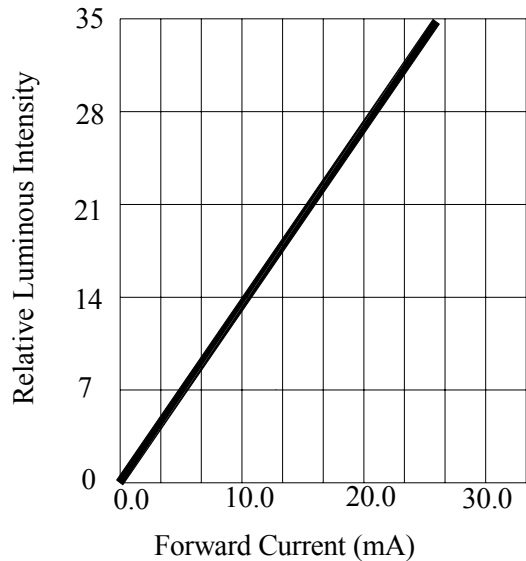

FORWARD CURRENT VS. LUMINOUS INTENSITY

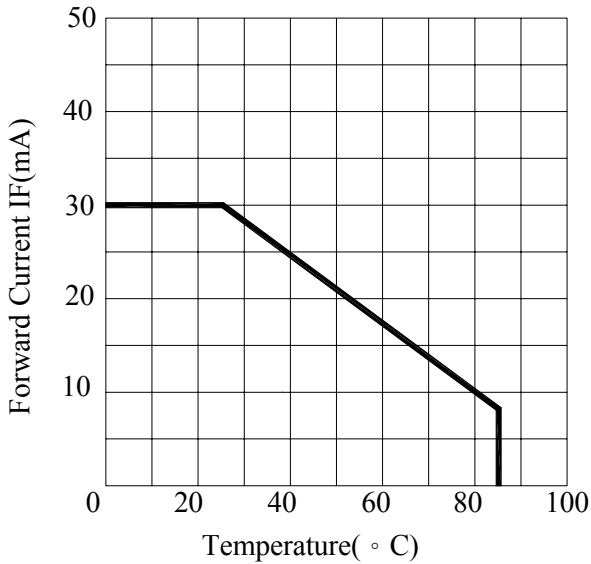

FORWARD CURRENT VS. AMBIENT TEMPERATURE

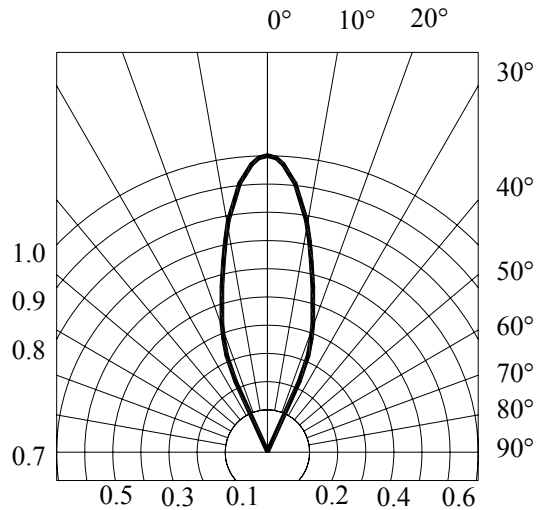

RADIATION DIAGRAM

Precautions:

TAKE NOTE OF THE FOLLOWING IN USE OF LED

1. Temperature in use

Since the light generated inside the LED needs to be emitted to outside efficiently, a resin with high light transparency is used; therefore, additives to improve the heat resistance or moisture resistance (silica gel, etc) which are used for semiconductor products such as transistors cannot be added to the resin.

Consequently, the heat resistant ability of the resin used for LED is usually low; therefore, please be careful on the following during use.

Avoid applying external force, stress, and excessive vibration to the resins and terminals at high temperature. The glass transition temperature of epoxy resin used for the LED is approximately 120-130 .

At a temperature exceeding this limit, the coefficient of linear expansion of the resin doubles or more compared to that at normal temperature and the resin is softened.

If external force or stress is applied at that time, it may cause a wire rupture.

2. Soldering

Please be careful on the following at soldering.

After soldering, avoid applying external force, stress, and excessive vibration until the products go to cooling process (normal temperature), <Same for products with terminal leads>

(1) Soldering measurements:

Distance between melted solder side to bottom of resin shall be 1.6mm or longer.

(2) Solder dip: Preheat: 90 max. (Backside of PCB), Within 120 seconds

Solder bath: 250 max. (Solder temperature), Within 5 seconds

(3) Soldering iron : 250 max. (Temperature of soldering iron tip), Within 3 seconds

3. Insertion

Pitch of the LED leads and pitch of mounting holes need to be same

4. Others



Since the heat resistant ability of the LED resin is low, SMD components are used on the same PCB, please mount the LED after adhesive baking process for SMD components. In case adhesive baking is done after LED lamp insertion due to a production process reason, make sure not to apply external force, stress, and excessive vibration to the LED and follow the conditions below.

Baking temperature: 120 max. Baking time: Within 60 seconds

If soldering is done sequentially after the adhesive baking, please perform the soldering after cooling down the LED to normal temperature.

Looking for pricing, stock, or lifecycle information?

Click below to explore more details on WIN SOURCE:

-  [View MT3118-Y-A on WIN SOURCE](#)
-  [Marktech Corporate Information](#)

Optimize Your Supply Chain with WIN SOURCE Solutions

-  Global Sourcing Solution
-  Obsolete Management
-  Cost Control Management
-  Shortage Management
-  Alternative Solution
-  Excess Inventory Management